

QT-6100

Touch Screen Smart Terminal

Reference Manual

Version 1.0 June 2008

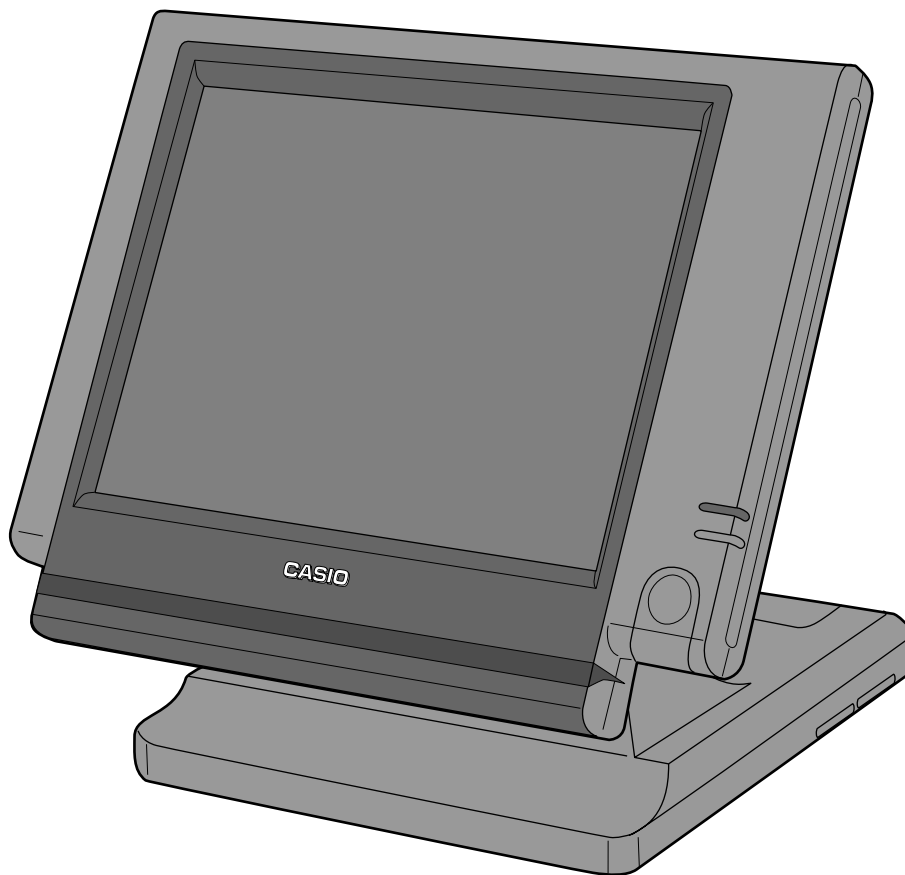

CASIO[®]

Preface

This manual is intended to be used as a reference to the QT-6100 system. It provides details to allow whole understanding of the system capabilities, its operation, and how it can be used to solve many problems within the retail outlet. This manual does not describe actual programming, which is covered in the QT-6100 programming manual.

This manual consists of the following chapters:

1. Introduction
This chapter describes the concepts of development of the QT-6100 system.
 2. Hardware configuration
This chapter outlines the hardware, optional devices and configurations of QT-6100 system.
 3. Application systems
This chapter outlines the application system and overviews the function provided for the QT-6100 system.
 4. Manager operation
This chapter explains the manager operations to use QT-6100 system.
 5. Registrations
This chapter explains actual registration operations with example.
 6. Refund mode operation
This chapter explains registrations in the RF or REG- mode.
 7. Read and reset
This chapter explains detail of the read and reset operations and reports.
 8. Appendices
These chapters show the record format and descriptions of individual files, total calculation method, meaning of error messages, etc.
- System down and recovery (in the Installation and Down Recovery manual)
This chapter explains actions to take and recovery methods when the system goes down.

Note: Casio reserves the right to change equipment and specifications without obligation and notification. The terms used in this manual may be different from those used in other manuals of Casio's product.

Printing history

Manual version

Version 1.0: June, 2008

Software version

First Edition: June, 2008

Version 1.0

Introduction

The QT-6100 is a versatile intelligent terminal developed in accordance with the following concepts.

1) System concept

Developing a high performance economical system by adopting the restaurant, bar, fast food system.

– Shared check tracking

The QT-6100 system has the capability of check tracking system.

– Shared printer system

All terminals can share remote printer(s).

– Collection, consolidation, and auto-program functions

The QT-6100 system is equipped with these functions by utilizing high-speed in-line data transfer system.

– Versatile terminal

With the QT-6100 system, any terminal has the same function, and can be designated as the master terminal by programming.

2) Software concept

A flexible application system for development, adopting the following methods:

– Function classified application system

3) Terminal hardware concept

Color LCD with touch panel

In addition to the above, the QT-6100 is also a terminal following characteristics:

– Expandability

The QT-6100 system can be connected to various peripheral devices (slip printer, modem, a personal computer, etc.)

– Reliability

The QT-6100 is provided with a self-diagnosis program so that the terminal can check the hardware. When a malfunction occurs during processing, an error report is logged into the system memory so that the error can quickly be corrected.

To prevent malfunctions caused by the weak batteries, charge the memory protection batteries for over 12-hours before installation or after a longtime vacation (over 30 days).

- **Before installation, initialize the terminal and leave it turn on over 12-hours.**
- **After a longtime vacation, initialize the terminal and restore the program data if the terminal is in malfunction, and leave it turn on over 12-hours.**
- **Over 48-hours charging makes the batteries fully charged.**

1.	Hardware configuration	R-10
1-1.	General configuration	R-10
1-2.	Hardware diagram	R-11
1-3.	Keyboard	R-12
1-4.	Display	R-13
1-5.	Cash drawer	R-14
1-6.	Input/output connectors	R-15
1-7.	Optional peripherals	R-16
1-8.	System configuration	R-17
2.	Application systems	R-23
2-1.	General description of application system	R-23
2-1-1.	File concept	R-23
2-1-2.	Linkage of totalizers	R-24
2-1-3.	Function keys	R-25
2-1-4.	Keyboard layout	R-25
2-1-5.	Mode control	R-26
2-1-6.	Operation prompt and error messages	R-26
2-1-7.	Printing control system	R-26
2-2.	General description of individual function keys	R-29
2-2-1.	System keys	R-29
2-2-2.	Finalize keys	R-30
2-2-3.	Transaction keys	R-30
2-3.	Remote printer control	R-38
2-3-1.	Remote printer system configuration	R-38
2-3-2.	Remote printer control setting	R-39
2-3-3.	Remote printer output control	R-40
2-3-4.	Remote printer backup processes	R-40
2-4.	Check tracking system	R-43
2-4-1.	Shared check tracking system	R-43
2-4-2.	Shared check tracking requirement	R-44
2-4-3.	Data backup when the master goes down	R-44
2-5.	Other check tracking system control	R-45
2-5-1.	The timing to clear check detail and index file after finalization	R-45
2-5-2.	Table transfer	R-45
2-5-3.	Store and recall	R-45
2-6.	Clerk control function	R-47
2-6-1.	Clerk interrupt	R-47
2-6-2.	Clerk detail memory	R-48
2-6-3.	Clerk training	R-48
2-6-4.	Manager mode control	R-48

Contents

2-7.	Arrangement key function and scheduler	R-50
2-7-1.	Arrangement key function	R-50
2-7-2.	Arrangement program example	R-54
2-7-3.	Scheduled execution of arrangement key function	R-54
2-8.	Making graphic logo	R-55
2-8-1.	About graphic logo	R-55
2-8-2.	Making graphic logo procedure	R-55
2-9.	Hourly item	R-56
2-9-1.	Programming necessary files before using hourly item function.	R-56
2-10.	Time and attendance	R-57
2-10-1.	Corresponding relations of the file	R-58
2-10-2.	Clock-in operation	R-60
2-10-3.	Clock-out operation	R-63
2-11.	Sign on control	R-65
2-11-1.	Sign on	R-65
2-11-2.	Solution to abnormality of master terminal	R-66
2-11-3.	Solution to abnormality of satellite terminal	R-66
2-11-4.	Sign on compulsory	R-66
2-12.	IDC (Item Data Capture)	R-67
2-12-1.	Available capturing items	R-67
2-12-2.	Set up the IDC start / end	R-70
2-12-3.	How to memorize the captured items	R-71
2-12-4.	IDC data file structure	R-72
2-12-5.	IDC data type	R-76
2-12-6.	Transferring IDC	R-77
2-13.	Electronic journal	R-78
2-13-1.	Storing electronic journal	R-78
2-13-2.	Issuing electronic journal report	R-78
2-13-3.	Displaying electronic journal and producing guest receipts after sales	R-78
2-13-4.	Transferring electronic journal memory	R-79
3.	Manager operation	R-82
3-1.	Machine initialization	R-82
3-1-1.	INIT	R-82
3-1-2.	Flag clear	R-82
3-1-3.	INIT 2	R-83
3-1-4.	INIT code	R-83
3-2.	IPL (Initial Program Loading)	R-83
3-2-1.	IPL	R-83
3-2-2.	System configuration before IPL operation	R-84
3-2-3.	IPL operation	R-85

3-3.	Manager function	R-86
3-3-1.	System connection check	R-86
3-3-2.	Remote on	R-87
3-3-3.	Remote off	R-87
3-3-4.	Busy reset	R-88
3-3-5.	Stock maintenance	R-89
3-3-6.	Drawer for clerk	R-90
3-3-7.	CHK# (Clerk interrupt)	R-90
3-3-8.	Order ID change	R-91
3-3-9.	Error log print	R-92
3-3-10.	System re-configuration	R-93
3-3-11.	Item Data Capture	R-94
3-3-12.	Euro change over	R-95
3-3-13.	Clerk window	R-96
3-3-14.	Customer	R-97
3-3-15.	Customer busy reset	R-98
3-3-16.	Sound	R-98
3-3-17.	Clerk number	R-99
3-3-18.	Operation monitor	R-99
3-3-19.	FTP client	R-99-1
3-4.	System command execution	R-100
3-4-1.	X/Z reporting	R-100
3-4-2.	X/Z collection / consolidation	R-101
3-4-3.	Remote power control	R-102
3-5.	Data Communication System	R-103
3-5-1.	Inline / online connectors	R-103
3-5-2.	Hardware interface	R-104
3-5-3.	Inline / online functions	R-106
3-6.	Collection/Consolidation system	R-107
3-6-1.	X/Z collection	R-109
3-6-2.	X/Z consolidation	R-111
3-6-3.	X/Z collection / consolidation	R-113
3-7.	Auto-programming function	R-116
3-7-1.	Auto-programming functions	R-116
3-7-2.	Auto-program operation and CF card utilities	R-117
4.	Registrations	R-122
4-1.	Clerk sign on / off operation	R-122
4-2.	Voiding the last registered item (<VOID> key operation)	R-123
4-3.	Voiding the previous registered item (<VOID> key operation)	R-124
4-4.	Cancelling of all data registered during the transaction	R-124
4-5.	Using the list function	R-126
4-6.	Using the set menu function and pulldown group function	R-127
4-7.	Post entry	R-130
4-8.	Separate check	R-131

Contents

4-9.	Open check	R-132
4-10.	Split payment (Dutch account)	R-132
4-11.	Media change	R-133
4-12.	Eat-in / Takeout	R-134
4-13.	Scanning PLU	R-134
4-14.	Shift PLU	R-135
4-15.	Printing barcode on receipts (UP-360)	R-135
4-16.	Round repeat function	R-136
4-17.	(future use)	
4-18.	Customer	R-138
4-19.	Table sharing	R-139
4-20.	Order character change	R-139
5.	Refund mode operation	R-142
5-1.	Selecting REF or REG- mode	R-142
6.	Read and reset operations	R-144
6-1.	The procedures of reading or resetting	R-144
6-2.	Report sample	R-146
	Appendix-1 Function key list	R-160
	Appendix-2. File format	R-164
	Appendix-3 Counter and Totalizer calculation method	R-194
	Index	R-206

1.	Hardware configuration	R-10
1-1.	General configuration	R-10
1-2.	Hardware diagram	R-11
1-3.	Keyboard	R-12
1-4.	Display	R-13
1-5.	Cash drawer	R-14
1-6.	Input/output connectors	R-15
1-7.	Optional peripherals	R-16
1-8.	System configuration	R-17

Hardware Configuration

1. Hardware configuration

This section outlines the hardware, optional devices, and configurations of the QT-6100 system.

1-1. General configuration

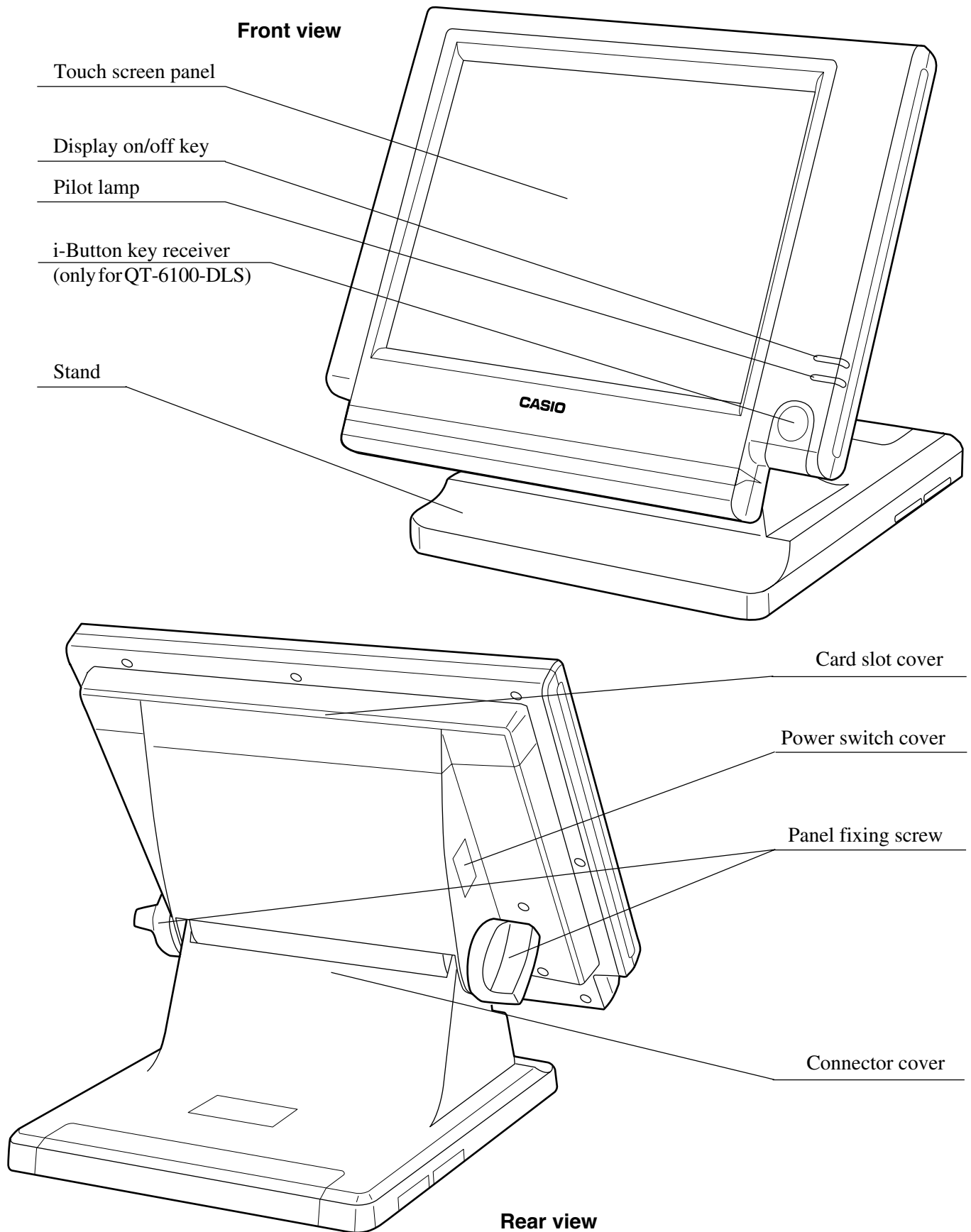

1-2. Hardware diagram

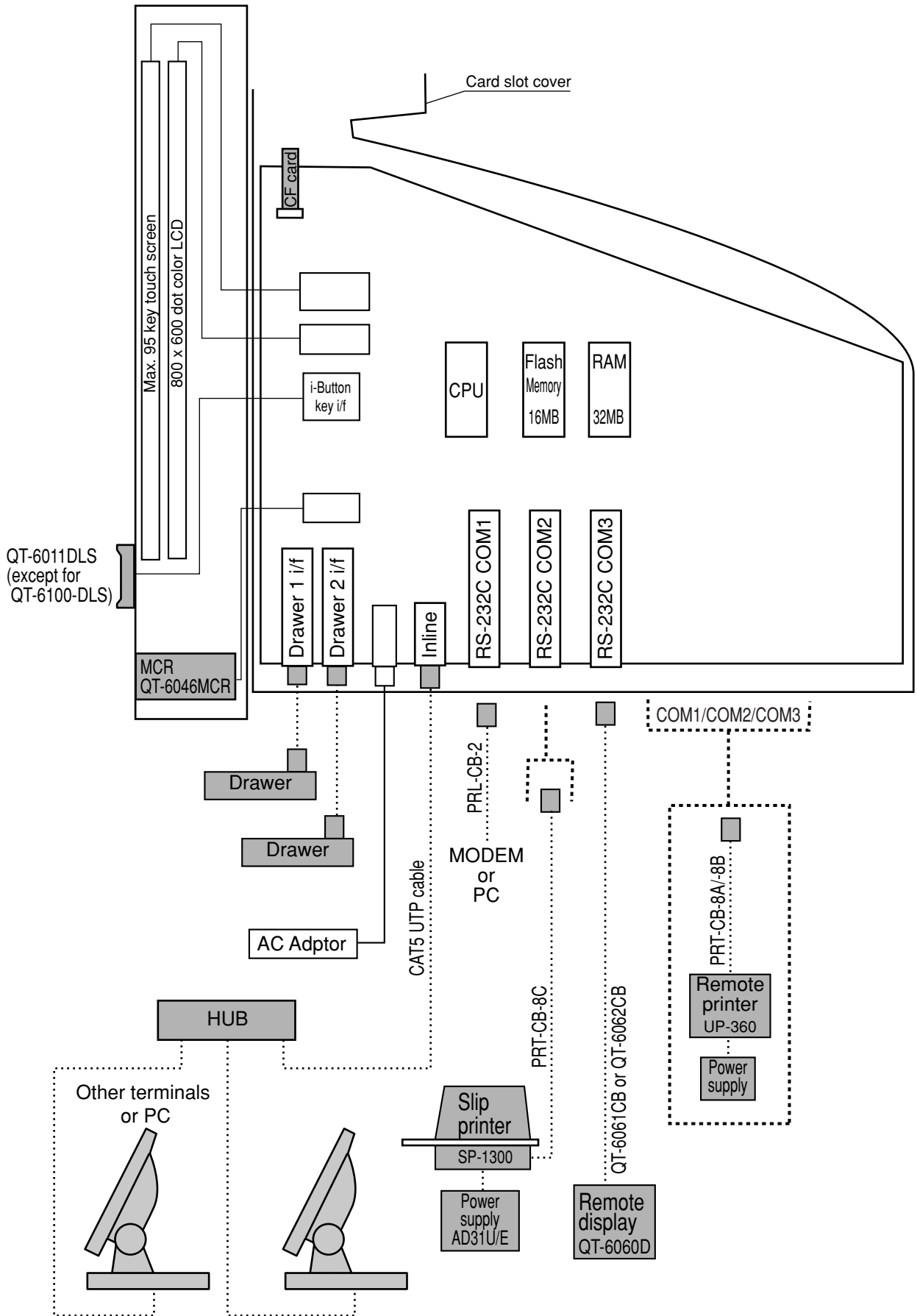

Note: Shaded device and dot line indicate option devices.

Hardware Configuration

1-3. Keyboard

1-3-1. Standard keyboard

REG C01 31-10-04 12:34 PM 001234							PAGE UP					
· 0.00							PLU010	PLU020	PLU030	PLU040	PLU050	
							↑	PLU009	PLU019	PLU029	PLU039	PLU049
							HOME	PLU008	PLU018	PLU028	PLU038	PLU048
							↓	PLU007	PLU017	PLU027	PLU037	PLU047
							PAGE DOWN	PLU006	PLU016	PLU026	PLU036	PLU046
ESC/SKIP	C	X	VOID	←	YES	NO	→	PLU005	PLU015	PLU025	PLU035	PLU045
CLK4	7	8	9	MODE	CLK#	COVERS	MENU	PLU004	PLU014	PLU024	PLU034	PLU044
CLK3	4	5	6	#/NS	FUNC LIST	SEP CHK	TBL TRANS	PLU003	PLU013	PLU023	PLU033	PLU043
CLK2	1	2	3	SUBTOTAL		FIN. LIST	NB	PLU002	PLU012	PLU022	PLU032	PLU042
CLK1	0	00	.	CASH/AMT /TEND		RECEIPT	NEW/OLD CHK	PLU001	PLU011	PLU021	PLU031	PLU041

- The keyboard layout is different by IPL.

1-3-2. Hard key code of keyboard

							045	055	065	075	085	095
							044	054	064	074	084	094
							043	053	063	073	083	093
							042	052	062	072	082	092
							041	051	061	071	081	091
							005	010	015	020	025	030
004	009	014	019	024	029	034	039	049	059	069	079	089
	(7)	(8)	(9)									
003	008	013	018	023	028	033	038	048	058	068	078	088
	(4)	(5)	(6)									
002	007	012	017	022	027	032	037	047	057	067	077	087
	(1)	(2)	(3)									
001	006	011	016	021	026	031	036	046	056	066	076	086
	(0)	(00)	(.)									

- In case of assigning a double or quadruple key, the key code of the key is shadowed part of the key.

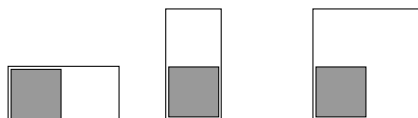

1-4. Display

1-4-1. Main display part

- ① Main display part: Used for displaying numeric entries, registration, subtotal amount, etc.
- ② Menu level display part: Used for displaying the current shift PLU, menu sheet and 2nd unit price level.
- ③ Keyboard part: Mainly used for keyboard (sometimes it is used for pop-up window)

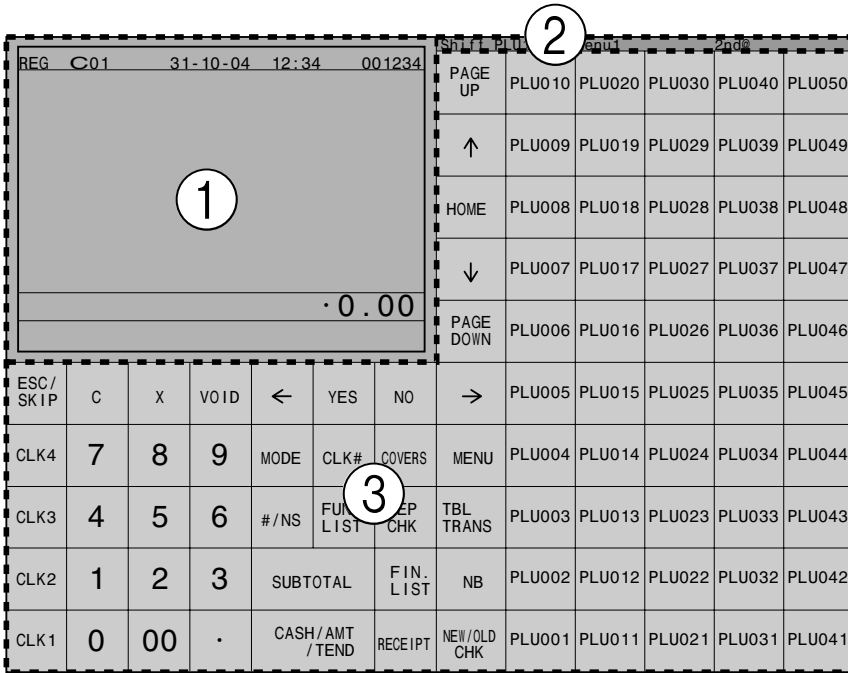

1-4-2. Main display part contents

The image shows a screenshot of the main display part contents. The display is organized as follows:

- Header:** REG C01 01-01-01 12:34 001234
- Item List:**
 - 1 Spagetti ·20.00 T1↑
 - 1 Spagetti ·20.00 T1
 - 7.5%
 - %-
 - 1.75 T1
 - 1 Coffee ·8.00
 - 1 Hamburger ·2.00 T1
 - 15%
 - %-
 - 0.30 T1
 - 1 Milk ·2.00
 - 2 Apple Juice ·5.00
 - 1 Coffee ·8.00 ↓
- Summary:**
 - Spagetti ·20.00
 - 76.50

Labels and annotations:

- Mode:** C01
- Clerk:** REG
- Date:** 01-01-01
- Time:** 12:34
- Consecutive number:** 001234
- Scroll area:** Indicated by a vertical bracket on the right side of the item list.
- Status Icons:** Located at the bottom left of the summary area.
- Items sold:** 12
- Total amount:** ·76.50
- Current transaction amount/change:** ·20.00

- Communication: ☒
- Master/BM error: ☒
- Cut off Master or BM: !
- Receipt on: ☒
- Character shift:
 - Double size: **A**
 - Standard size: **A**

Hardware Configuration

1-4-3. Menu level display part contents

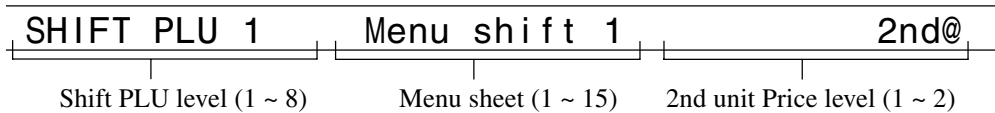

1-4-4. Main display brightness control

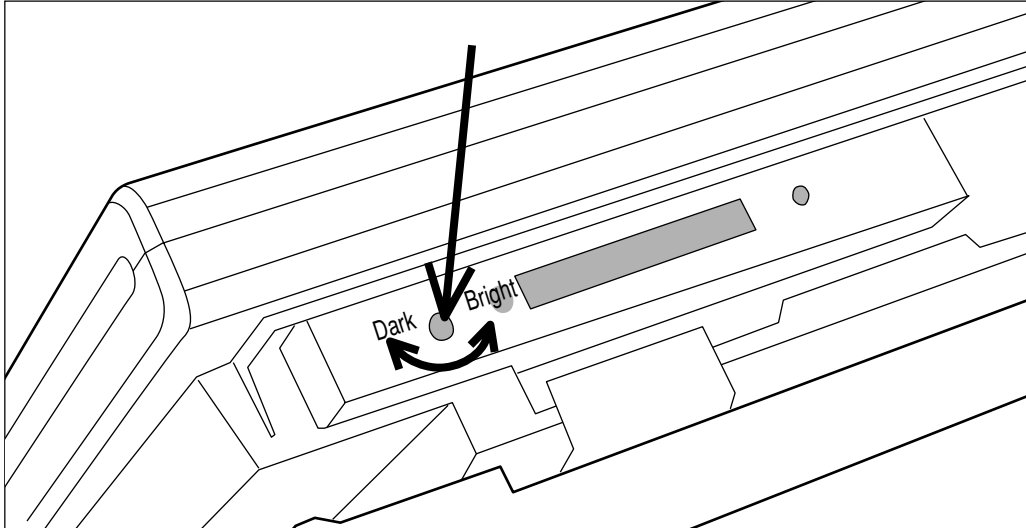

1-5. Cash drawer

In case of connecting drawer, follow the procedure below.

Connect the drawer.

1. Connect drawer connector (three color lead on drawer) to the terminal.
2. Connect frame drawer connector (green lead on drawer) to the terminal.

Mount the cash register.

1. Screw in 2 fixing screws bottom side of the terminal.
2. Mount the terminal on the top of the drawer, ensuring that the feet on the bottom of the terminal go into the holes on the drawer.

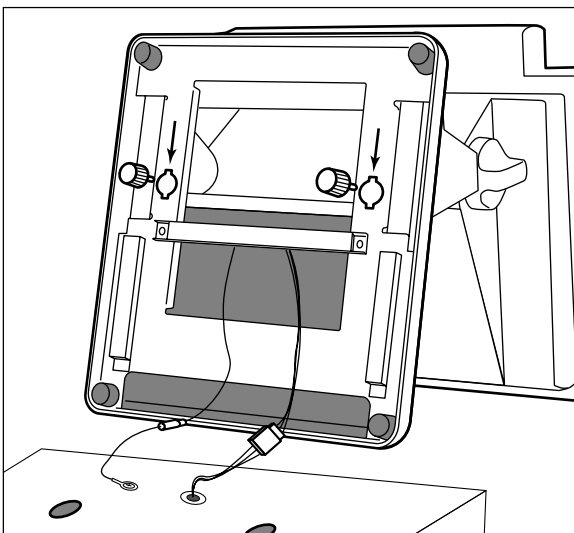

1-6. Input/output connectors

Power switch

Main power switch is located in the power switch cover.

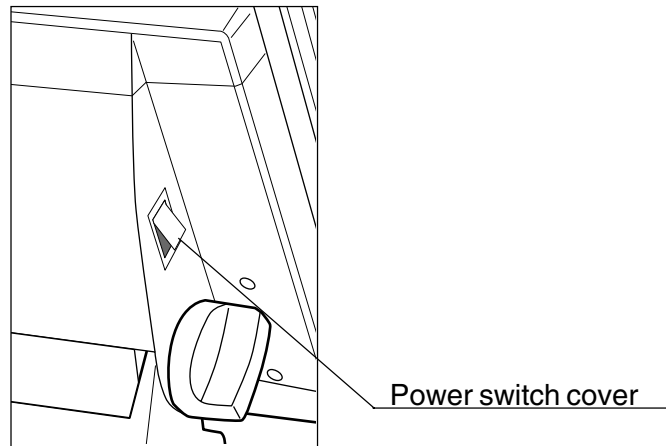

Input /output connectors

Inline connector, COM port, and drawer cable are located in the bottom connector cover.

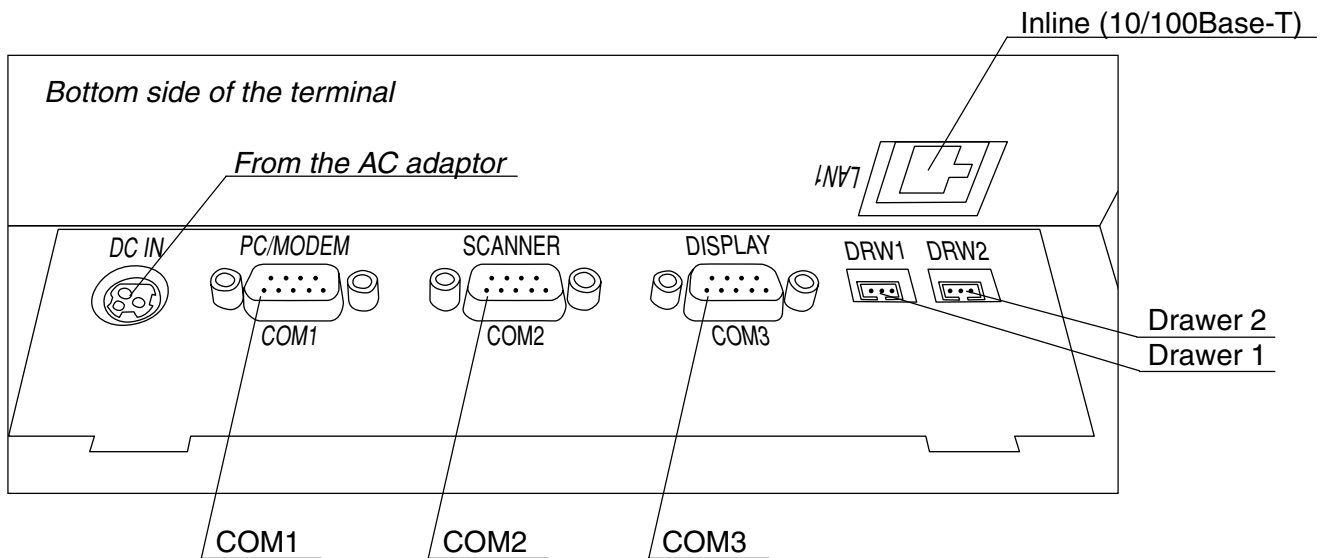

Hardware Configuration

1-7. Optional peripherals

The following optional peripherals can be used by plugging them into the appropriate port.

- 1) Personal computer / MODEM: RS-232C COM 1 port
- 2) Scanner: RS-232C COM 2 port
- 3) Remote display (QT-6060D) : RS-232C COM 3 port
- 4) Remote printer (UP-360): RS-232C COM 1 ~ 3 port
The remote printer is used for reports/kitchen orders/receipts.
- 5) Slip printer (SP-1300) : RS-232C COM 2 or 3 port
SP-1300 can not be connected to COM 1 port.
- 6) Inline: Inline port
You can use CAT5 UTP cable.
- 7) Drawer: drawer port
- 8) CF card: CF card slot (in the card slot cover)

1-8. System configuration

This section represents the system configuration of the QT-6100. The QT-6100 have three different system configurations, such as shared check tracking / floating clerk interrupt system, Inline collection / consolidation system and Online collection / consolidation system.

Before detail explanation, we should define the words:

1) Check master:

Check master is the master server of shared check tracking system and floating clerk interrupt system. This terminal has check index and detail files and controls them.

2) Check backup master:

Check backup master is the backup server of shared check tracking system and floating clerk interrupt system. This terminal also has check index and detail files and update them at the same timing of master.

When the check master goes down, the backup master plays the role of check master.

3) Check self master:

Check self master has its check tracking system files and clerk interrupt files for itself.

4) Satellite:

The terminal which is not assigned to 1) ~ 3) above.

5) Remote printer:

Remote printer prints data sent from both its own terminal and other terminal of the system.

6) Local printer:

Local printer prints data sent from its own terminal.

1-9-1. Shared check tracking system/floating clerk interrupt system

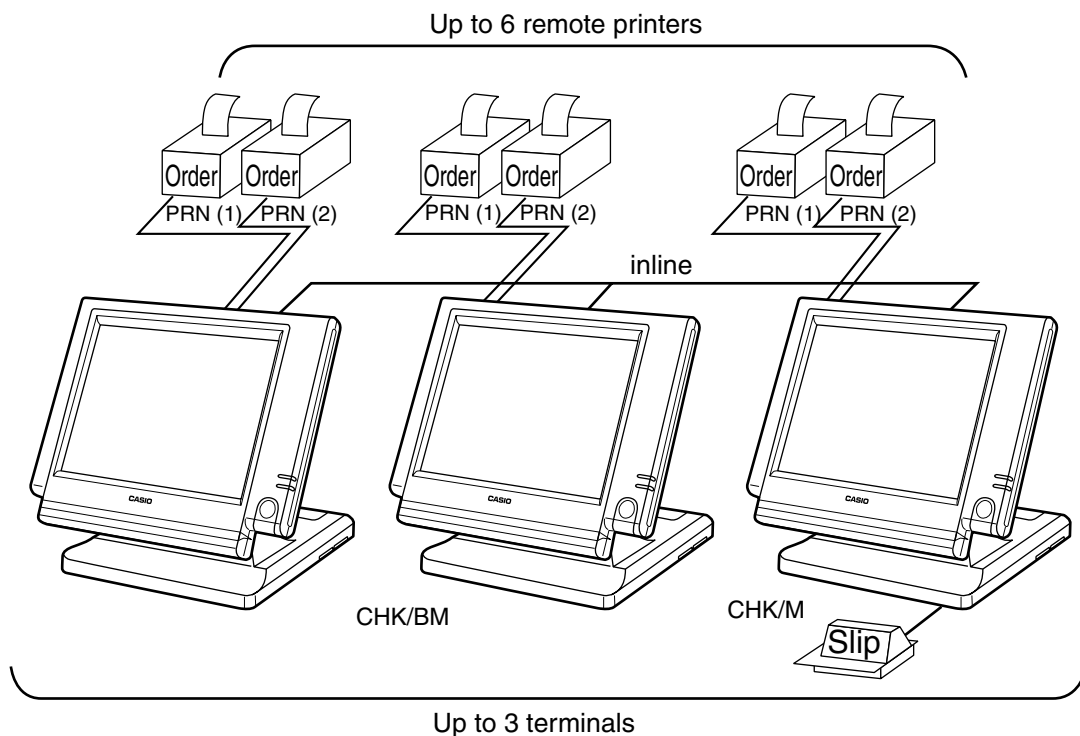

Hardware Configuration

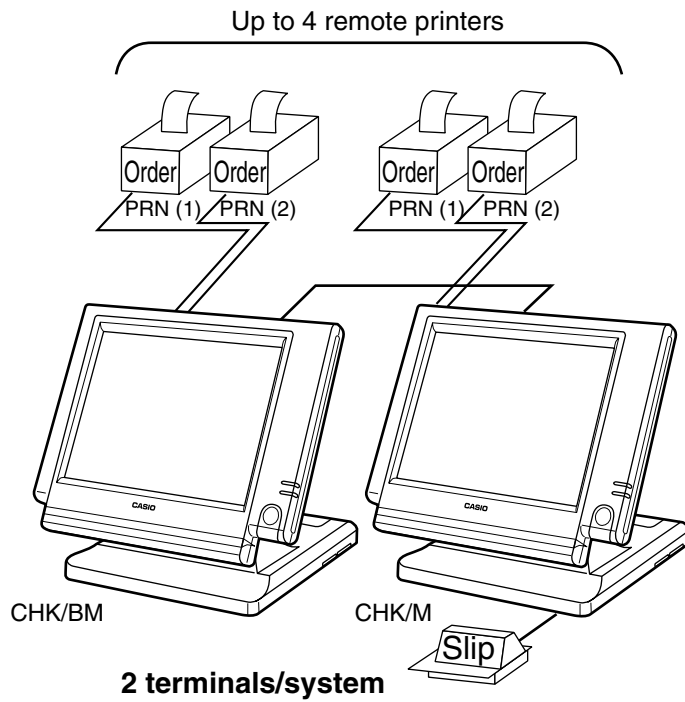

Available peripherals versus ECR definition

✓: Available

ECR definition	Peripherals		
	Remote printer	Slip printer	PC/MODEM
Check master	✓	✓	✓
Check backup master	✓	✓	✓
Self master	✓	✓	✓
Satellite	✓	✓	✓

Available combinations ECR definition

✓: Available

ECR definition	Check master	Check backup master	Self master	Terminal w/ remote printer
Check master				✓
Check backup master				✓
Self master				✓
Terminal w/ remote printer	✓	✓	✓	

Note:

- 1) Please follow the system recommendation above. Otherwise the system performance may be slow down.

1-8-2. Inline collection/consolidation system

- Inline collection/consolidation and auto-programming for up to 3 terminals.

Note: Maximum 2 remote printers in the 1 terminal system, 4 remote printers / 2 terminal system, 6 remote printers in the 3 terminal can be defined.

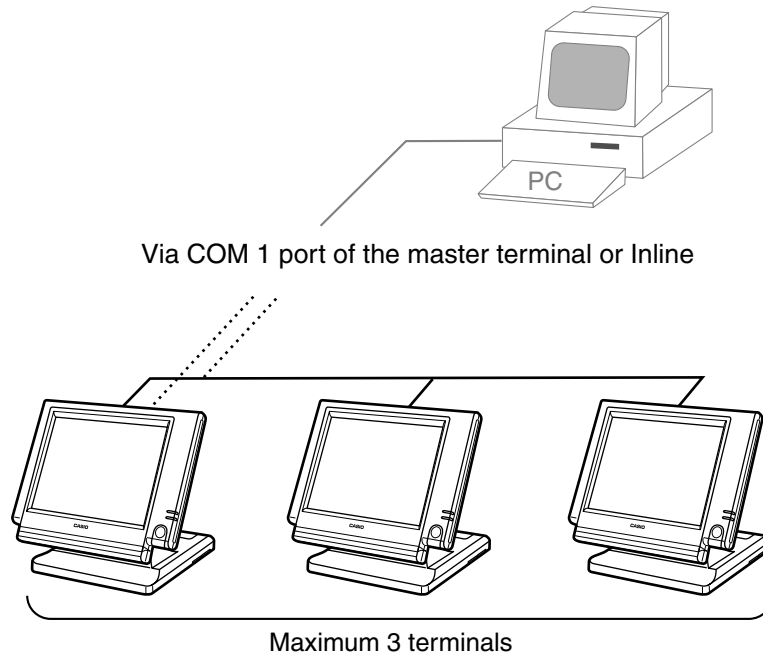

1-8-3. Online collection / consolidation system

- Online collection / consolidation and auto-programming for up to 3 terminals.

Note: Maximum 2 remote printers in the 1 terminal system, 4 remote printers / 2 terminal system, 6 remote printers in the 3 terminal can be defined.

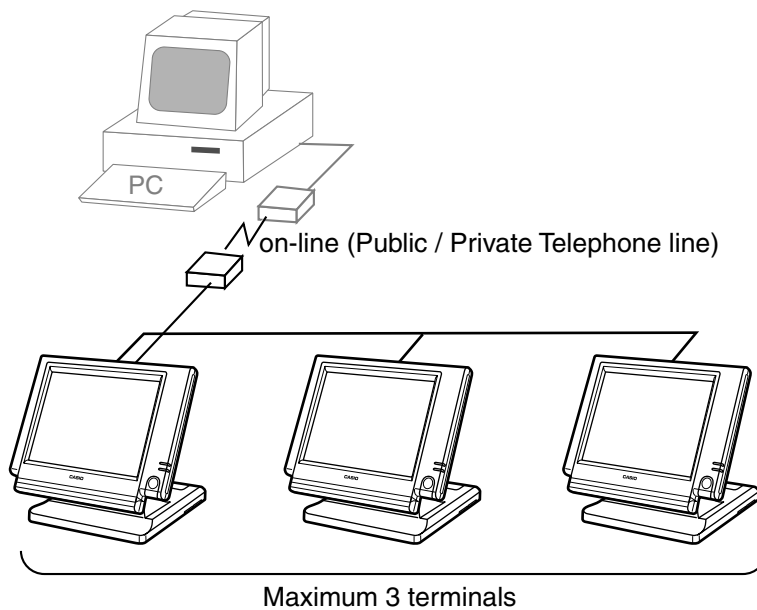

Hardware Configuration

1-8-4. Online collection / consolidation system (use FTP feature)

- Online collection / consolidation and auto-programming for up to 3 terminals.

Note: Maximum 2 remote printers in the 1 terminal system, 4 remote printers / 2 terminal system, 6 remote printers in the 3 terminal can be defined.

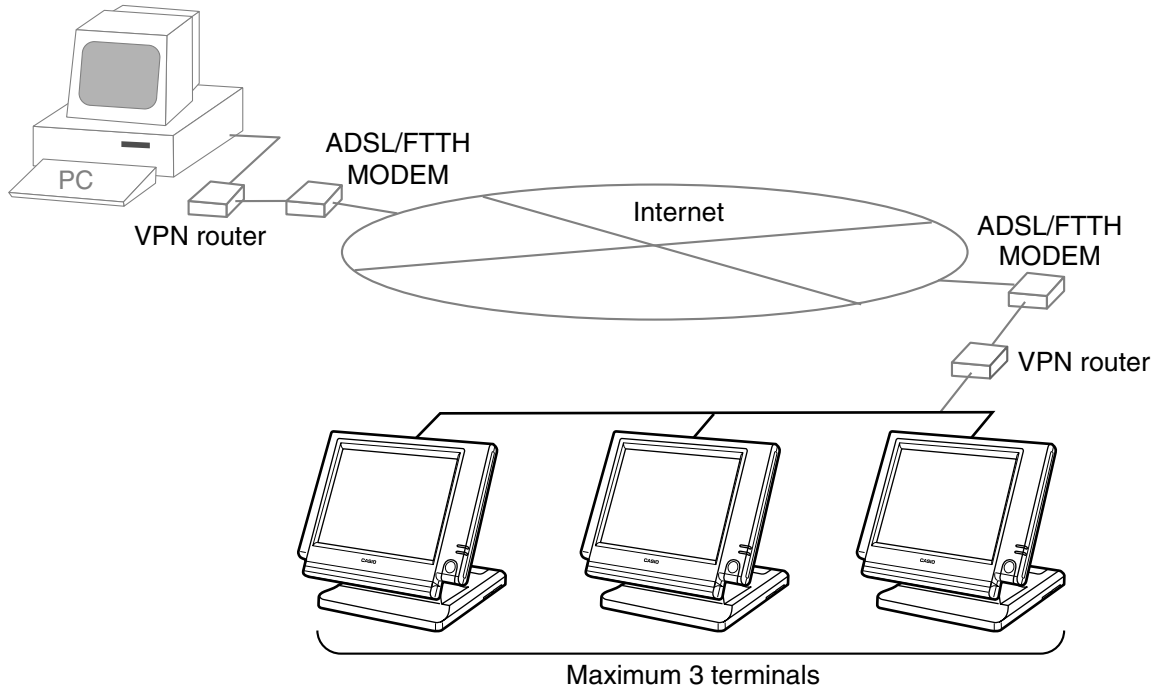

2.	Application systems	R-23
2-1.	General description of application system	R-23
2-1-1.	File concept.....	R-23
2-1-2.	Linkage of totalizers	R-24
2-1-3.	Function keys	R-25
2-1-4.	Keyboard layout	R-25
2-1-5.	Mode control	R-25
2-1-6.	Operation prompt and error messages	R-26
2-1-7.	Printing control system.....	R-26
2-2.	General description of individual function keys.....	R-29
2-2-1.	System keys	R-29
2-2-2.	Finalize keys	R-30
2-2-3.	Transaction keys	R-30
2-3.	Remote printer control	R-38
2-3-1.	Remote printer system configuration	R-38
2-3-2.	Remote printer control setting	R-39
2-3-3.	Remote printer output control	R-40
2-3-4.	Remote printer backup processes	R-40
2-4.	Check tracking system.....	R-43
2-4-1.	Shared check tracking system	R-43
2-4-2.	Shared check tracking requirement	R-44
2-4-3.	Data backup when the master goes down	R-44
2-5.	Other check tracking system control.....	R-45
2-5-1.	The timing to clear check detail and index file after finalization	R-45
2-5-2.	Table transfer	R-45
2-5-3.	Store and recall	R-45
2-6.	Clerk control function	R-47
2-6-1.	Clerk interrupt	R-47
2-6-2.	Clerk detail memory	R-48
2-6-3.	Clerk training	R-48
2-6-4.	Manager mode control	R-48
2-7.	Arrangement key function and scheduler	R-50
2-7-1.	Arrangement key function	R-50
2-7-2.	Arrangement program example	R-54
2-7-3.	Scheduled execution of arrangement key function	R-54
2-8.	Making graphic logo	R-55
2-8-1.	About graphic logo	R-55
2-8-2.	Making graphic logo procedure	R-55
2-9.	Hourly item	R-56
2-9-1.	Programming necessary files before using hourly item function.....	R-56
2-10.	Time and attendance	R-57
2-10-1.	Corresponding relations of the file	R-58
2-10-2.	Clock-in operation	R-60
2-10-3.	Clock-out operation	R-63

Application System

2-11. Sign on control	R-65
2-11-1. Sign on	R-65
2-11-2. Solution to abnormality of master terminal	R-66
2-11-3. Solution to abnormality of satellite terminal	R-66
2-11-4. Sign on compulsory	R-66
2-12. IDC (Item Data Capture)	R-67
2-12-1. Available capturing items	R-67
2-12-2. Set up the IDC start / end	R-70
2-12-3. How to memorize the captured items	R-71
2-12-4. IDC data file structure	R-72
2-12-5. IDC data type	R-76
2-12-6. Transferring IDC	R-77
2-13. Electronic journal	R-78
2-13-1. Storing electronic journal	R-78
2-13-2. Issuing electronic journal report	R-78
2-13-3. Displaying electronic journal and producing guest receipts after sales	R-78
2-13-4. Transferring electronic journal memory	R-79

2. Application systems

This section describes the configuration of application system and their related setting with the QT-6100. Reading this section provides a general understanding of the overall system of the terminal.

2-1. General description of application system

2-1-1. File concept

Programming data for each function, as well as registration data, are assigned and handled in the RAM of the terminal in data blocks called files. Each files identified by a 3-digit file number consists of multiple records.

Memory management on a file basis allows flexibility memory allocation in accordance with the application of a specific terminal. The number of records per file can be programmed, and a file can even be programmed for zero records.

There are three types of files:

- Terminal files:
Terminal files include system work files, daily total files, periodic total 1, periodic total 2 files, buffer files, and program files. Periodic total files have only totalizer field, and totalize the same data which is accumulated to terminal files at the same time. The periodic total 1 files have 100 order file numbers, and the periodic total 2 files have 200 order file numbers.
These files can be reset individually and separately from the terminal files. This provides access to weekly and monthly total data. The periodic total 1 files and 2 files have the same functions, and can accumulate data with different periods. The same number of records as the corresponding terminal file must be reserved for each periodic total files.
- Consolidation files:
Consolidation files are work files for consolidation of daily total, periodic 1 total and periodic 2 total data from each terminal, and have 300, 400 and 500 order file numbers, respectively. The same number of records as the corresponding terminal files must be reserved for each file, on the master terminal.
- Consolidation work files:
Consolidation work files are work files for collection/consolidation of daily, periodic 1/2 data from each terminal. The files have 600 order file numbers.
The file number of records as the corresponding terminal file must be reserved for each consolidation file.

Each file requires an internal work area, so calculation of actual file size can be performed using the following formula:

$$\text{Record length} \times \text{Number of records} + \text{Work area} = \text{Actual file size}$$

The table on the page 14 ~ 17 of the programming manual shows all the files available for the terminal. See the Appendix A-2 of this manual for detail formats of individual files.

Application System

2-1-2. Linkage of totalizers

Registered data is accumulated to totalizers which are reserved for each functions.

The QT-6100 has the following types of totalizers:

- 1) Fixed totalizers
Registration data is accumulated for individual terminals.
- 2) Function key totalizers
Data input by finalize or transaction keys is accumulated in totalizers for each key. Operation types, as well as data used in operation differ depending on the key.
- 3) Subdepartment totalizers
Registration data is accumulated in totalizers for each subdepartment.
- 4) Department totalizers
Registration data is accumulated in totalizers for each department.
- 5) Group totalizers
Registration data is accumulated in totalizers for each group.
- 6) PLU totalizers
Registration data is accumulated in totalizers for each PLU.
- 7) Clerk totalizers
Registration data is accumulated for each relevant clerk. A clerk detail totalizer can be linked to a fix totalizer, finalize key, transaction key, or item totalizer (department / PLU / subdepartment / group), and accumulate data registered for the destination totalizer of each relevant clerk.
- 8) Other totalizer
Functions for hourly sales, monthly sales void reason, table analysis, time attendance and hourly item also have totalizers.

Registration data flow

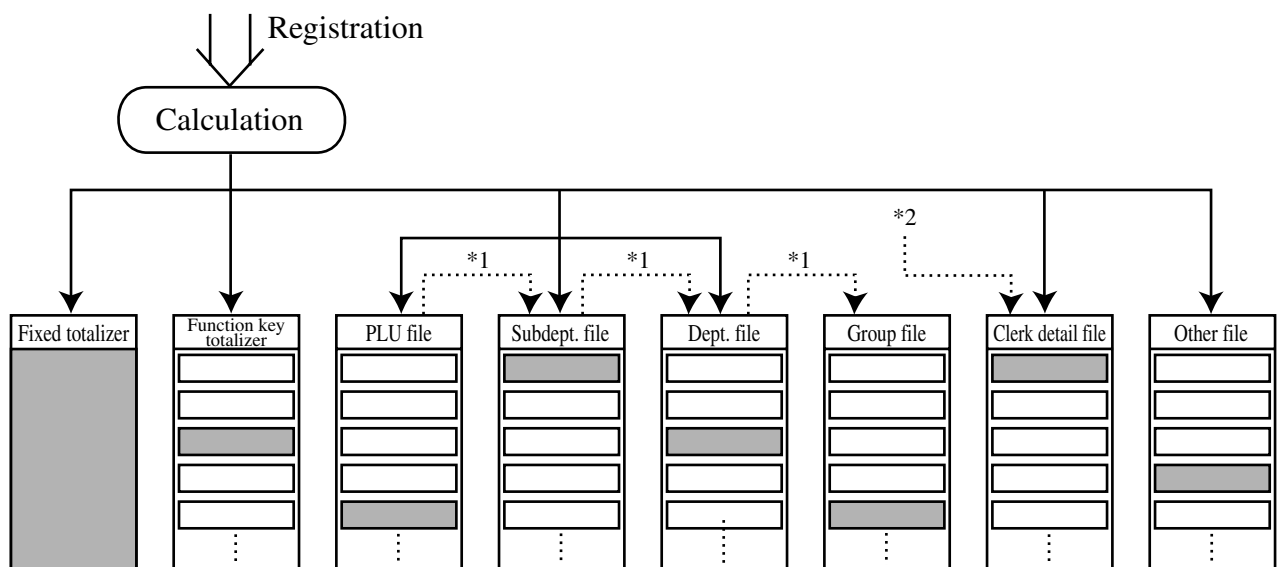

*1 Linking between PLUs, subdepartments, departments and groups can be programmed to meet the needs of the retail environment.

PLUs can be programmed to link with subdepartments, departments or group, while subdepartment can be programmed to link with department or group, and department can be programmed to link with group.

When a PLU is programmed to link with a department, data registered for the PLU is also accumulated to the department. In addition, when the department is programmed to link with a group, data registered for the PLU is simultaneously reflected the department totalizer and group totalizer.

*2 When data is registered to a totalizer which is preset in the clerk detail link table, the data is also accumulated to the clerk detail totalizer reserved for each relevant clerk.

2-1-3. Function keys

The keys on the keyboard can be assigned various functions that are used for registration as required for the terminal. For convenience sake, these functions are called by function keys.

There are two types of function keys:

1) System keys

Numeric keys, clear key, home position key, left / right / up / down arrow keys, yes key, no key, mode selection keys, ESC/SKIP key, page up / down key are system keys.

2) Function keys

These function keys are used for finalize a transaction, to specify the functions for a registration or to specify the meaning of a entry. These function keys have programmable functions, which are set to the transaction key / department / subdepartment / PLU file.

Function keys include finalize key, transaction key, department key, subdepartment key and flat PLU key.

The list of all function keys is shown in the Program 4 chapter of the programming manual. General descriptions of individual function keys are found in the chapter 2-2.

2-1-4. Keyboard layout

Normally, the keyboard is assigned functions which are required for registration of transactions. The keyboard is also used for character input when entering descriptors or names during programming.

The QT-6100 automatically switches the keyboard to its character input function when it determines that character input is required for the operation sequence you are performing. This means that you can input characters without having to worry about manually changing the keyboard input mode.

The function key (except system keys) allocation is fully programmable to meet the specific needs of each terminal. The actual programming of key layouts can be performed in the PGM4 mode, and programmed data is written onto the key table (file 074/174).

The allocation can also be programmed when programming each function file for programming function keys such as finalize keys, transaction keys, department keys, subdepartment keys, and flat PLU keys.

Character key layout

Refer to the page 104, 105 of the programming manual.

2-1-5. Mode control

With the QT-6100, each clerk can be programmed to enable or disable operations in the following modes:

- REF mode
- REG- mode
- REG mode
- X/Z mode
- Program 1 ~ 6 mode
- Manager mode
- Inline X/Z mode
- Inline auto program
- CF backup / restore mode

Also, each clerk can be programmed to enable or disable operations of every function key. Though the terminal has no actual REG 2 mode, on the page 48 in the Clerk Control function chapter of this manual, the manager control procedure is described.

Arrangement execution mode programmed in the arrangement key ignores the mode control program by the clerk.

Please note that if a clerk want to operate an arrangement, he / she should allow to operate arrangement function.

2-1-6. Operation prompt and error messages

The QT-6100 displays messages to indicate the status of the terminal being operated or programmed. These messages help to determine the status of the terminal or the required subsequent action.

2-1-6-1. Operation prompt

Refer to the page 201 of this manual for details. These messages cannot be added, modified or deleted.

2-1-6-2. Error messages

Refer to the page 198 ~ 200 of this manual for details. Error messages are displayed to indicate that an error has occurred and a compulsory operation must be performed. All error messages cannot be added, modified or deleted.

2-1-7. Printing control system

The following describes the control system for printing of receipts, the journal, validation, slips and X/Z reports.

2-1-7-1. Receipt print control during normal registration

Normally, the receipt is printed to reflect the details of a registration as it is performed, with the receipt being issued with the finalize operation. By using the <RECEIPT ON/OFF> key, the receipt issuance status can be turned off to suspend printing and issuance of receipts when so desired. Pressing the <RECEIPT ON/OFF> key turns the receipt issuance status on or off, and when the receipt issuance status is On, the icon "RECEIPT ON" appears.

The following programming can be performed for receipt printing:

Description	Program location
Receipt "Item consolidation"	PGM3; Machine Control3 in General Feature
Receipt "Sort by group, department"	PGM3; Machine Control3 in General Feature
Print consecutive number on the receipt	PGM3; Machine Control3 in General Feature
Print date / time on the receipt	PGM3; Machine Control3 in General Feature
Vertical double character	PGM3; Machine Control3 in General Feature
Set menu detail on guest / slip	PGM3; Print Control in General Feature
Print PLU number	PGM3; Print Control in General Feature
Print finalized total	PGM3; Print Control in General Feature
Print taxable amount	PGM3; Print Control in General Feature
Print taxable status	PGM3; Print Control in General Feature
Print total number of item sold	PGM3; Print Control in General Feature
Print customer number (number of covers)	PGM3; Print Control in General Feature
One line feed after finalization	PGM3; Print Control in General Feature
Time format (24H / 12H)	PGM3; Print Control in General Feature

2-1-7-2. Validation print control

The QT-6100 allows use of the slip printer (SP-1300) for validation printing of item registrations, function registrations and sales totals. To perform validation printing, insert the validation paper into the slip printer, and then press the <VALIDATION> key (function code 037).

The following description shows the print format for validation performed using the slip printer.

There are three general types of validation printing:

- 1) Finalization validation
- 2) Transaction validation
- 3) Item validation

Finalization validation is performed following finalization operations with finalize keys. When a validation is performed following receipt issuance, the sales total or tendered amount is printed, while partial tendering, the tendered amount for the specified medium is printed.

Transaction validation is valid for the following function keys:

- Received on account, Paid out, finalization of Pick up or Loan, Check cashing, Minus, Plus, Discount, Premium, Void, Coupon, Coupon2, Tip, Deposit, Subtotal, Merchandise subtotal keys

You can program the allowable number of validation printings or multiple validation printing status for the above listed keys.

Also some of these keys can be programmed as validation compulsory, this means that registration is not permitted until the validation of the former registration has been performed.

Item validation is performed directly following an item registration listed below.

- Departments
- Subdepartments
- PLUs

You can program the multiple validation printing status for above items.

2-1-7-3. Slip print control

Connection of an optional slip printer (SP-1300) to the QT-6100 makes it possible to print transaction details on a slip.

To print a slip, insert a slip paper into the printer, and adjust paper position by entering the number of printed lines and pressing the <SLIP FEED/RELEASE> key (function code 056) or the <SLIP BACK FEED/RELEASE> key (function code 054) and then press the <SLIP PRINT> key (function code 055). Or it is possible to find the appropriate slip printing start line automatically.

After printing a slip, the paper is automatically released.

If the paper is not released for some reasons, press <SLIP FEED/RELEASE> or <SLIP BACK FEED/RELEASE> to release the paper.

Before using slip printer, you should program the maximum lines of slip.

The following two sections are other features to control slip printing format:

2-1-7-4. Endorsement message print control

The QT-6100 allows printing of endorsement messages on the slip printer (SP-1300) for check registrations. To perform endorsement message printing, insert the paper into the slip printer following finalization using the <CHECK> key or check cashing transaction using the <CHECK> key, and press the following key:

- Endorsement key (function code 039)

Check key and check cashing key can be programmed for compulsory endorsement print. The endorsement message contents should be programmed into the endorsement message file (file 033).

2-1-7-5. Check printing print control

The QT-6100 allows printing check tendered amount on a check inserted into the slip printer. To perform check printing, insert the paper into the slip printer following check finalization using the <CHECK> key, and press the following key:

- Check print key (function code 012)

Check key can be programmed for compulsory check print. The check printing format is controlled by the check print file (file 041).

2-1-7-6. X/Z report print control

The QT-6100 can output a report in the read (X) or reset (Z) mode. The following shows the programming for X/Z print controls:

Description	Program location
Items on the fixed totalizer report	PGM3; Report Control1 in General Feature
Items zero skip	PGM3; Report Control2 in General Feature
Average spend/item on monthly report	PGM3; Report Control2 in General Feature
PLU order (memory / random code)	PGM3; Report Control2 in General Feature
Print / Non print PLU No. on PLU report	PGM3; Report Control2 in General Feature
Print / Non print Sales ratio	PGM3; Report Control2 in General Feature
Print / Non print Z counter	PGM3; Report Control2 in General Feature
Print / Non print Item discount totalizer	PGM3; Report Control2 in General Feature
Print GT	PGM3; Report Control2 in General Feature

2-2. General description of individual function keys

This section describes individual function key that can be assigned to the keys on the keyboard of QT-6100.

2-2-1. System keys

The system key consist on a non-programmable function key.
The following system keys are available.

1) Numeric keys (0, 1 ~ 9, 00, 000, decimal point)

These keys are used for inputting numerical data such as PLU codes, amounts, quantities, etc. These keys must be allocated on the keyboard.

2) Clear key

This key is used for clearing numerical values after they have been input, and after incorrect function keys have been pressed. This key also can be used to clear errors. This key must be allocated on the keyboard.

3) Home position key

This key is used for returning cursor to the home position.

4) Left, right, up, down arrow keys

These keys are used for moving the cursor.

5) Yes key

This key is used for consenting the selection and proceeding steps.

6) No key

This key is used for cancelling the selection and proceeding steps.

7) Mode key

This key is used for changing modes of the terminal. This key shows the allowable mode keys in the mode pop-up window.

8) ESC/SKIP key

This key is used for terminating a programming sequence, X/Z sequence, and returning the former window. This key is also used for terminating a report being issued in PGM, X, and Z mode.

9) Display on/off key

This key is used for turning on / off the terminal.

10) Page up key

This key is used for turning the window forwards.

11) Page down key

This key is used for turning the window backwards.

Application System

2-2-2. Finalize keys

This section covers the general description of each finalize key, with its respective options. Finalize keys have programmable functions which may be used as required.

1) Tender key

This key is used for finalizing transactions. Up to six media in drawer totalizers are reserved in the fixed totalizer file, and cash key is linked to cash in drawer, charge key to charge in drawer, check key to check in drawer and credit key to credit in drawer, food stamp tender key to food stamp in drawer, EBT tender key to EBT in drawer.

When this key is pressed, the total amount of the transaction is calculated. Normally, a receipt is issued and the drawer opens at the same time. The total amount is added to the appropriate totalizers and counters, with consecutive numbers being increased by one. When an amount exceeding the sales amount is received, the change is calculated, displayed and printed on the receipt.

This key can also be used in combination with other finalize keys for partial tender and can also be used to specify the type of media during loan, pick up or media change operation. Programmability: Refer to page 83, 84 of the programming manual.

2) New balance key

This key is used for adding the latest registered total amount to the previous balance to obtain a new balance.

When this key is pressed, the total amount of the transaction is calculated. Normally, a receipt is issued.

Programmability: Refer to page 84 of the programming manual.

2-2-3. Transaction keys

Each of the transaction keys have programmable functions which may be used as required. The general description of each transaction key, with individual options, is outlined on the following sections.

1) Price inquiry key (Function code 008)

This key is used to confirm the price and descriptors of PLU without registering.

2) Stock inquiry key (Function code 009)

This key is used to confirm the stock quantity and descriptors of PLU without registering.

3) Text recall key (Function code 010)

This key is used to recall characters.

Programmability: Refer to page 85 of the programming manual.

4) Text print key (Function code 011)

This key is used to print the entered characters.

Programmability: Refer to page 85 of the programming manual.

5) Check print key (Function code 012)

This key is used to print the check on the slip printer (SP-1300). Pressing this key allows the selection from the following list to print on a check.

1. Check amount in Arabic numerals (normal size / double size)
2. Date (normal size / double size)
3. Check print message in the check endorsement message file

This item noted above can be arranged into a check print format according to the needs of the store. Check printing using this key is valid only for the following operation of the check key.

Programmability: Refer to page 85 of the programming manual.

6) Clerk transfer key (Function code 013)

This key is used to transfer opened checks to another clerk.

Programmability: Refer to page 86 of the programming manual.

7) Table transfer key (Function code 014)

This key is used to transfer the contents of a check to another check.
Programmability: Refer to page 86 of the programming manual.

8) Tip key (Function code 015)

This key is used to register tips.
Programmability: Refer to page 87 of the programming manual.

9) Normal receipt key (Function code 016)

This key is used to change the order status from Bon to normal and from single item sales to normal.

10) Loan key (Function code 019)

This key inputs the amount of money provided for making change. This operation affects media totals, rather than sales totals.
Loans are made for all types of money which can be specified by finalize keys.
Programmability: Refer to page 87 of the programming manual.

11) Received on account key (Function code 020)

This key is used to register amounts received for purposes other than sales transactions. This transaction affects media totals, rather than sales totals.
Programmability: Refer to page 87 of the programming manual.

12) Paid out/Euro key (Function code 021)

This key is used to register amounts of paid outs from the terminal. This transaction affects media totals, rather than sales totals. If the terminal has the file 099 (Euro program file), this key also works as “Euro” key. Euro key has the following features: (1) Converting the main currency to the sub currency, when registering a subtotal amount. (2) Specifying sub currency while entering an amount for payment.
Programmability: Refer to page 87 of the programming manual.

13) Pick up key (Function code 022)

When sales receipts are removed from the drawer or when the amount in-drawer exceeds the limit value (sentinel function), the manager performs a pick up operation. This key is used for this function. This operation affects media totals, rather than sales totals. Pick ups are made for all types of money which can be specified by finalize keys.
Programmability: Refer to page 87 of the programming manual.

14) Coupon key (Function code 023)

This key is used for registering coupons. This operation affects the coupon amount in the coupon totalizers. The registered coupon amounts is not deducted from the department, PLU or gross totalizers, but from the net totalizers only. (selecting GROSS specification)
Programmability: Refer to page 88 of the programming manual.

15) Deposit key (Function code 025)

This key is used to register deposits.
Programmability: Refer to page 89 of the programming manual.

16) Minus key (Function code 027)

This key is used to register subtraction. This operation affects the subtraction amount in the minus key totalizers. The registered amounts is not deducted from the department, PLU or gross totalizers, but from the net totalizers only. (selecting GROSS specification)
Programmability: Refer to page 88 of the programming manual.

17) Discount key (Function code 028)

This key applies a preset % or manual input % to obtain the discount amount for the last registered item or subtotal.
Programmability: Refer to page 90 of the programming manual.

18) Plus key (Function code 029)

This key is used for registering surcharge. This operation affects the surcharge amount in the plus key totalizers. The registered amounts is not added to the department, PLU or gross totalizers, but from the net totalizers only. (selecting GROSS specification)

Programmability: Refer to page 88 of the programming manual.

19) Premium key (Function code 030)

This key applies a preset % or manual input % to obtain the premium amount for the last registered item or subtotal.

Programmability: Refer to page 90 of the programming manual.

20) Refund key (Function code 033)

This key declares next input for a return money.

Programmability: Refer to page 100 of the programming manual.

21) Error correct/Void key (Function code 034)

This key is used to correct the last registered item, discount, premium, partial tendered, etc. This key also invalidates proceeding data registered for departments subdepartments, PLUs or set menus only.

Programmability: Refer to page 89 of the programming manual.

22) Coupon 2 key (Function code 036)

This key is used to register coupons. The registered coupon amounts is deducted from the department, subdepartment, PLU or gross totalizers and the net totalizers.

23) Validation key (Function code 037)

This key validates item or transaction amounts on slips. Validation can be made compulsory for certain function keys. Multiple validation can be prohibited for certain function keys.

24) Receipt key (Function code 038)

This key issues a receipt for the last transaction (post-finalization receipt) when the original receipt is not issued. This key also issues a guest receipt. The guest receipt can be designated by seat number.

Programmability: Refer to page 91 of the programming manual.

25) Check endorsement key (Function code 039)

This key is used to print a preset check endorsement using the slip printer.

Programmability: Refer to page 89 of the programming manual.

26) Non-add key (Function code 040)

This key prints reference numbers (personal check number, card number etc.)

Programmability: Refer to page 91 of the programming manual.

27) Non-add / No sale key (Function code 041)

This key prints reference numbers (personal check number, card number etc.)

This key also opens the drawer between transaction.

Programmability: Refer to page 91 of the programming manual.

28) No sale key (Function code 042)

This key opens the drawer between transaction.

29) Number of customer key (Function code 043)

This key registers the number of customers.

Programmability: Refer to page 92 of the programming manual.

30) Arrangement key (Function code 044)

This key is used to activate an arrangement program programmed in the arrangement file. Any operation that can be performed from the keyboard, as well as mode, can be programmed in an arrangement program, and can be performed merely by pressing this key.

The mode control function of this key can be programmed for all modes.

Programmability: Refer to page 92 of the programming manual.

31) Currency exchange key (Function code 045)

This key converts foreign currency to local currency or vice versa using the exchange rate preset for the key and displays the result.

This key is used for conversions of a home currency subtotal or merchandise subtotal to equivalent of another country's currency.

This key is also used for conversion of another country's currency payment to the equivalent of the home currency.

Programmability: Refer to page 93 of the programming manual.

32) VAT key (Function code 046)

This key is used to print VAT breakdowns.

33) Bill copy key (Function code 047)

This key is used to issue bill copy.

34) PLU key (Function code 048)

This key is used to enter PLU numbers.

35) Price key (Function code 049)

This key is used in the following transactions to enter a unit price.

- Department registration using the department number key
- Subdepartment registration using the subdepartment number key
- Open PLU registration

In case of the department or subdepartment registration mentioned above, the Price key is pressed after entering the unit price to override a unit price preset to the department or subdepartment. If the preset price is to be registered as it is, simply press the Price key.

36) Department key (Function code 051)

This key is used to register items for a department.

Programmability: Refer to page 80 of the programming manual.

37) Slip back feed / Release key (Function code 054)

This key is used to back feed slips inserted into the slip printer. This is done by specifying the number of feed lines. This key is also used to release the slip paper holder if numbers are not entered.

38) Slip print key (Function code 055)

This key is used to execute a slip batch printing on the slip printer. Pressing this key prints the sales details. Actual printing is performed following receipt issuance.

Programmability: Refer to page 93 of the programming manual.

39) Slip feed / Release key (Function code 056)

This key is used to feed slips inserted into the slip printer. This is done by specifying the number of feed lines. This key is also used to release the slip paper holder if numbers are not entered.

40) Tax status shift key (Function code 057)

This key activates tax table which is specified by the tax status programmed for this key. The tax status is programmed for the departments, subdepartments, PLUs, minus, plus, discount and premium keys. Pressing this key during registration converts taxable item to non taxable, and non taxable item to taxable.

Programmability: Refer to page 93 of the programming manual.

41) Table number key (Function code 058)

This key is used to input table numbers.

42) Food stamp status shift key (Function code 059)

The food stamp status is programmed for the departments, subdepartments, PLUs, minus, plus, discount and premium keys. Pressing this key during registration converts food stampable item to non stampable, and non stampable item to stampable.

- 43) Tax exempt key (Function code 062)**
This key is used to change taxable amounts to nontaxable amounts. This key works adding on a tax system only.
Programmability: Refer to page 97 of the programming manual.
- 44) Flat PLU key (Function code 063)**
This key is used to register items to flat PLU.
Programmability: Refer to page 78 of the programming manual.
- 45) Menu shift key (Function code 064)**
This key is used to shift Flat PLU key to the n-th (n = 1 ~ 8) menu.
Programmability: Refer to page 99 of the programming manual.
- 46) Shift PLU key (Function code 065)**
This key is used to shift a Flat PLU key to the n-th (n = 1 ~ 8) level.
Programmability: Refer to page 99 of the programming manual.
- 47) Open key (Function code 067)**
This key is used to release the maximum amount limit or low digit limit (programmable) for an amount which exceeds the limit.
Programmability: Refer to page 94 of the programming manual.
- 48) Open 2 key (Function code 068)**
This key is used to suspend the compulsory specifications listed below.
Programmability: Refer to page 94 of the programming manual.
- 49) First unit price key (Function code 069)**
This key is used to register a specific item at the first unit price.
- 50) Second unit price key (Function code 070)**
This key is used to register a specific item at the second unit price.
- 51) Clerk number key (Function code 072)**
This key is used to assign a clerk's secret number.
Programmability: Refer to page 95 of the programming manual.
- 52) Operator read / reset key (Function code 073)**
This key is used to issue a clerk's individual X/Z report.
Programmability: Refer to page 95 of the programming manual.
- 53) Tray total key (Function code 074)**
This key is used to obtain the sectional subtotal amount.
Programmability: Refer to page 99 of the programming manual.
- 54) Subtotal key (Function code 075)**
This key is used to obtain subtotal amount with add-on tax and previous balance.
Programmability: Refer to page 95 of the programming manual.
- 55) Receipt On / Off key (Function code 076)**
This key is used to change the status "Receipt issue" or "No receipt."
– Receipt off / Receipt and journal off
- 56) Taxable amount subtotal key (Function code 077)**
This key is used to obtain taxable amount subtotal.
Programmability: Refer to page 93 of the programming manual.
- 57) Operator number key (Function code 078)**
This key is used to enter a clerk number during clerk transfer.
- 58) Merchandise subtotal key (Function code 080)**
This key is used to obtain subtotal excluding the add-on tax amount and the previous balance.
Programmability: Refer to page 95 of the programming manual.

59) Food stamp subtotal key (Function code 081)

This key is used to obtain food stamp subtotal. This key should be pressed just before <FOOD STAMP> or <EBT> finalization.

60) Quantity / For key (Function code 083)

This key provides the same functions as the multiplication key. In addition, this key also has a split pricing function. The function is used to calculate the price per unit for particular items, which are sold in bulk in order to obtain the total amount for the number of units purchased.

Programmability: Refer to page 96 of the programming manual.

61) Square key (Function code 084)

This key provides the same functions as the multiplication key. In addition, this key also has a square multiplication function.

Programmability: Refer to page 96 of the programming manual.

62) Selective item subtotal key (Function code 085)

This key is used to obtain the selective item 1 / 2 subtotal amount.

In addition to the common programming, this key has the following option:

- Selective item status 1 / 2

63) Cube key (Function code 090)

This key provides the same functions as the multiplication key. In addition, this key also has a cube multiplication function.

Programmability: Refer to page 96 of the programming manual.

64) New check key (Function code 091)

This key is used in a check tracking system to input a new check number in order to open a new check under that number.

Programmability: Refer to page 98 of the programming manual.

65) Old check key (Function code 092)

This key is used in a check tracking system to input the number of an existing check (previously created by the New check key) whose details are stored in the check tracking memory. Existing checks are reopened to perform further registration or to finalize them.

Programmability: Refer to page 99 of the programming manual.

66) New / Old check key (Function code 093)

This key is used in a check tracking system to input check numbers in order to open new checks and to reopen existing checks. When the clerk inputs a check number, the terminal checks to see if that number already exists in the check tracking memory. If there is no matching number in the memory, a new check is opened under the input number. If the check number input matches a number already stored in the memory, that check is reopened for further registration or finalization.

Programmability: Refer to page 98 of the programming manual.

67) Add check key (Function code 094)

This key is used in a check tracking system to combine the details of more than one check into a single check.

68) Separate check key (Function code 095)

This key is used in a check tracking system to separate selected items or to separate by seat number from one check to another check.

69) OBR (Optical Barcode Reader) key (Function code 103)

This key is used to enter scanning PLU code manually.

70) Clock-in/out key (Function code 108)

This key is used to register the time when employees start/finish their job.

Programmability: Refer to page 97 of the programming manual.

71) Break-in / out key (Function code 109)

This key is used to register the starting / finishing time when employees have a recess.
Programmability: Refer to page 97 of the programming manual.

72) (future use)

73) Substitution key (Function code 111)

Replaces group PLU with a PLU not preset in the pulldown menu.

74) Ketten Bon key (Function code 113)

This key is used to enter quantities for multiplication. Multiplication by this key issues singular order prints.
Programmability: Refer to page 96 of the programming manual.

75) House Bon key (Function code 114)

This key is used to register items for in-store use.

76) Post entry key (Function code 115)

This key is used in a check tracking or clerk interrupt system to indicate the reserved item of set menu and register it as a fixed item later on.

- Enter post entry

Press this key while the window is opened, the key descriptor appears on the screen and it is registered as a reserved item.

- Fix post entry

After finishing the set menu registration, move the cursor on to the reserved item, press this key again, then the appropriate window will be opened to fix it.

77) Round repeat key (Function code 116)

This key is used to register the same items which were ordered just before.
Programmability: Refer to page 98 of the programming manual.

78) Open check key (Function code 117)

This key is used to issue an open check report of an assigned clerk.
Programmability: Refer to page 96 of the programming manual.

79) Media change key (Function code 118)

This key is used to change media in drawer amounts. Pressing this key enters media change operation.

80) Seat number key (Function code 119)

This key is used to enter and print seat number.

81) Eat-in key (Function code 128)

This key is used to specify if the customer eats in the restaurant. Before closing a transaction, press this key.
Programmability: Refer to page 98 of the programming manual.

82) Takeout key (Function code 129)

This key is used to specify if the customer takes out items. Before closing a transaction, press this key for the tax exemption.
Programmability: Refer to page 98 of the programming manual.

83) Store key (Function code 130)

This key is used for storing the check number of the registered items. Allocate this key to the terminal at the drive-through entrance. When this key is pressed, registered item data will be stored, and then these data will transfer to the youngest check number.
Programmability: Refer to page 98 of the programming manual.

84) Recall key (Function code 131)

This key is used for recalling the transferred check number by the store key. When you press this key, the check number will appear in order of the oldest record.

Programmability: Refer to page 99 of the programming manual.

85) Subdepartment key (Function code 133)

This key is used to register items for the subdepartment.

Programmability: Refer to page 79 of the programming manual.

86) Subdepartment number key (Function code 134)

This key is used to enter subdepartment numbers.

87) Department number key (Function code 135)

This key is used to enter department numbers.

88) List key (Function code 136)

This key is used to display menu lists.

Programmability: Refer to page 96 of the programming manual.

89) List number key (Function code 137)

This key is used to designate list number.

90) Dutch account key (Function code 140)

This key is used to share the total payment by customer.

Programmability: Refer to page 99 of the programming manual.

91) Customer ID number key (Function code 148)

This key is used to enter customer ID number.

92) Payment key (Function code 149)

This key is used to declare the following transactions as payment.

93) Electronic journal display key (Function code 207)

This key is used to display the stored journal.

94) Display mode key (Function code 219)

This key is used to change display modes (normal mode/item consolidation mode).

95) Cancel key (Function code 236)

Invalidates all preceding data registered for departments, PLUs and set menus within a transaction. This key must be pressed before the transaction involving the data to be invalidated is finalized. It is also effective even after calculation of subtotal amount.

Programmability: Refer to page 96 of the programming manual.

96) Item search key (Function code 246)

Use this key to search an item by its name.

Programmability: Refer to page 100 of the programming manual.

97) Order character change key (Function code 252)

This key is used to change the order character. The order characters not only of the item but in the order character table can be printed.

Programmability: Refer to page 100 of the programming manual.

98) Location change key (Function code 260)

Use this key to select the pop-up window which shows the table layout of each floor/part of the restaurant.

Programmability: Refer to page 100 of the programming manual.

99) Table sharing key (Function code 261)

Use this key to assign one table to two or more customer groups.

Application System

2-3. Remote printer control

Up to eight printers for printing kitchen orders etc.

2-3-1. Remote printer system configuration

Please refer to page 17 for the system configuration.

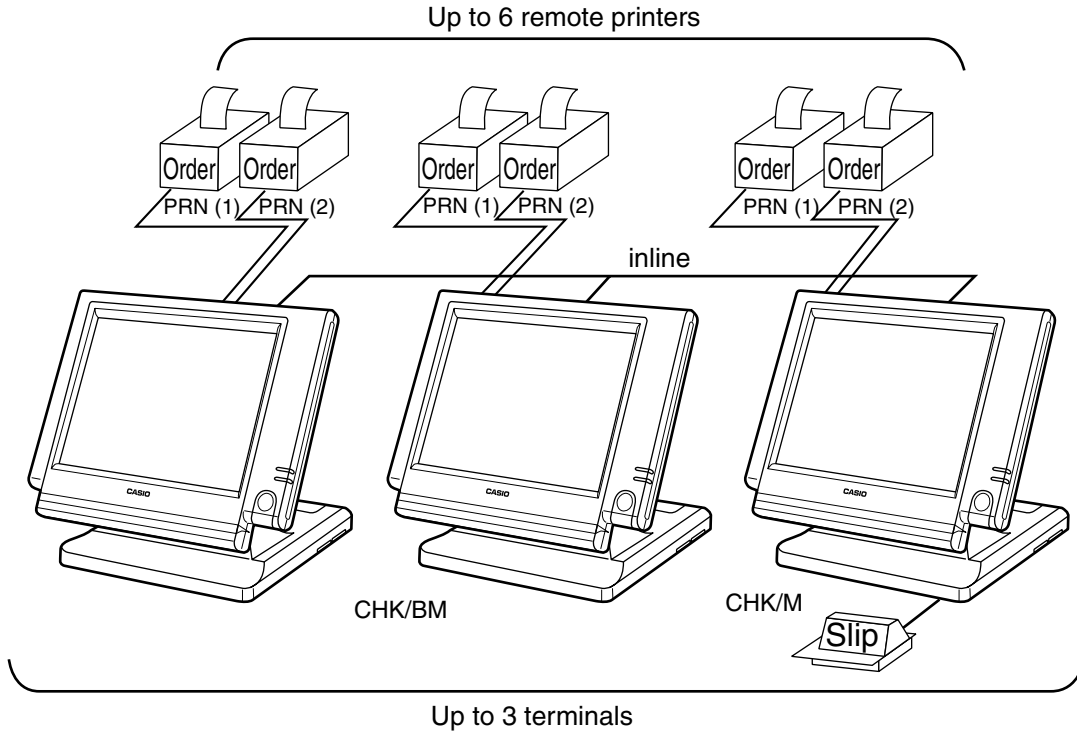

The printing processing of the remote printer is performed as shown in the figure below.

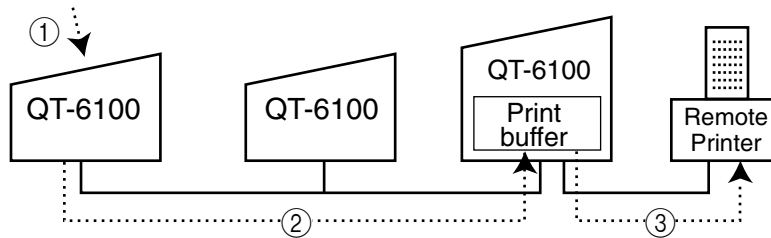

- ① A transaction is made at a terminal.
- ② The terminal sends printing data to the terminal with remote printer.
- ③ The terminal with remote printer sends data to the remote printer.

2-3-2. Remote printer control setting

Remote printer settings:

After changing the DIP switch configuration, remote printer initialization (power on by pressing the <LF> key) is necessary.

UP-360

Dip switch is located at the bottom of the printer.

SW No.	Function	ON	OFF	
1	1	Reset by DTR	Yes No	
	2	reserved	--- fixed	
	3	Protocol	DTR/DSR XON/XOFF	
	4	Transmission speed	See transmission speed setting	
	5			
	6	Parity	See paritysetting	
	7			
	8	undifined	---	---
	9	Low power consumption	Yes	No
	10	undifined	---	---



UP-360 Bottom view

Transmission speed setting			Parity setting		
bps	SW No.			SW No.	
	4	5		6	7
4800	OFF	OFF	Non	OFF	OFF
9600	OFF	ON	Even	OFF	ON
19200	ON	OFF	Odd	ON	OFF
38400	ON	ON	Non	ON	ON

Memory allocation of files required when remote printers are connected

- Registration buffer (file 036)
 - Printer buffer (file 035)
- (Reallocate these files, if the file sizes are not enough.)

Other setting

- General machine features

2-3-3. Remote printer output control

The following print items are controlled by programming.

- 0 to 9 line feed above and below printing (only for “order”)
- Dashed line print control (only for “order”)
- Paper auto cut (only for “order”)
- Data communication speed
- Backup remote printer specification
- Print color (normal / reverse or black / red) control: included in the item programming (only for “order”)
- Output remote logical order number: included in the item programming (only for “order”)
- Remote printer output in training mode (only for “order”)
- Item amount printing (only for “order”)
- Alert when remote printer is down

2-3-4. Remote printer backup processes

Remote printer error or terminal with remote printer error

In case of the backup printer is assigned, when the terminal which sends printing data to remote printer detects the remote printer or the terminal with remote printer abnormality, the remote printer cross backup (see the next section) is made. In case of no backup printer is assigned or the backup printer is also downed, the data will be able to print on the internal receipt / journal printer.

Remote printer cross backup

When there is more than one remote printer in the system, a setting can be made to enable remote printer cross backup.

Cross backup (example):

Remote printer 1 backup → Remote printer 2

Remote printer 2 backup → Remote printer 1

or

Remote printer 1 with terminal 1 backup → Remote printer 2 with terminal 2

Remote printer 2 with terminal 2 backup → Remote printer 3 with terminal 1

Note that remote printer backup extends a single level only. If remote printer 1 goes down in the above example, remote printer 2 performs backup printing. If remote printer 2 now goes down, remote printer 3 does not take over backup printing.

Remote printer print sample

1) Order printing (Normal receipt printing with amount)

Soft Drinks				Order character
Check No.123456		MC #01		Check number / Machine ID
REG C01	15-12-2003	12:34	001230	Mode / Clerk / Date / Time / Consecutive No.
1 Lemon Tea			•1.00	Order with amount
2 Coffee			•2.00	
-----				Cut or print dot line

2) Order printing (Single bon/double bon)

Soft Drinks				Single Bon
CHECK NO.123456		MC #01		
REG C01	15-12-2003	12:34	001234	
1 Lemon Tea				
-----				Cut or print dot line
Soft Drinks				Double Bon
CHECK No.123456		MC #01		
REG C01	15-12-2003	12:34	001234	
2 Coffee				
-----				Double Bon message
STUB				
Soft Drinks				Order character
CHECK No.123456		MC #01		Check number/Machine ID
REG C01	15-12-2003	12:34	001234	Mode / Clerk / Date / Time / Consecutive No.
2 Coffee				

3) Order printing (Normal receipt printing without amount)

Soft Drinks			
CHECK No.123456		MC #01	
REG C01	15-12-2003	12:34	001256
1 Lemon Tea			
2 Coffee			
2 Coffee			

Application System

4) Order printing (Set menu/preparation/condiment)

CHECK No. 123456		MC #01
REG C01	15-12-2003 12:34	001267
2	Steak Set	Set menu
2	Medium	Detail item
2	Salad	
1	Pizza	Main item
1	Soft	Preparation
1	Cheese	Condiment
1	Tomato	
1	Pizza	Main item
	#123456	Main item PLU No.
1	Soft	Preparation (with quantity / PLU No.)
	#000001	
1	Cheese	Condiment (with quantity / PLU No.)
	#000002	
1	Tomato	
	#000003	

2-4. Check tracking system

2-4-1. Shared check tracking system

Up to 3 terminals can be included and check tracking can be performed for multiple terminals connected to inline. This means that any terminal can be used to recall a temporary closed check for additional registration or finalization.

System configuration

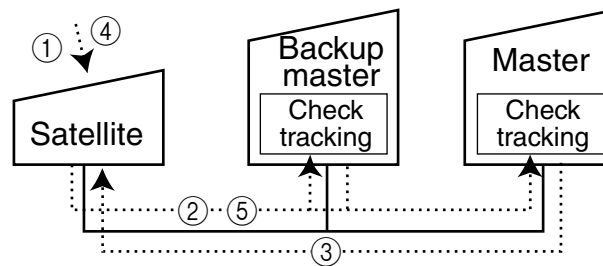
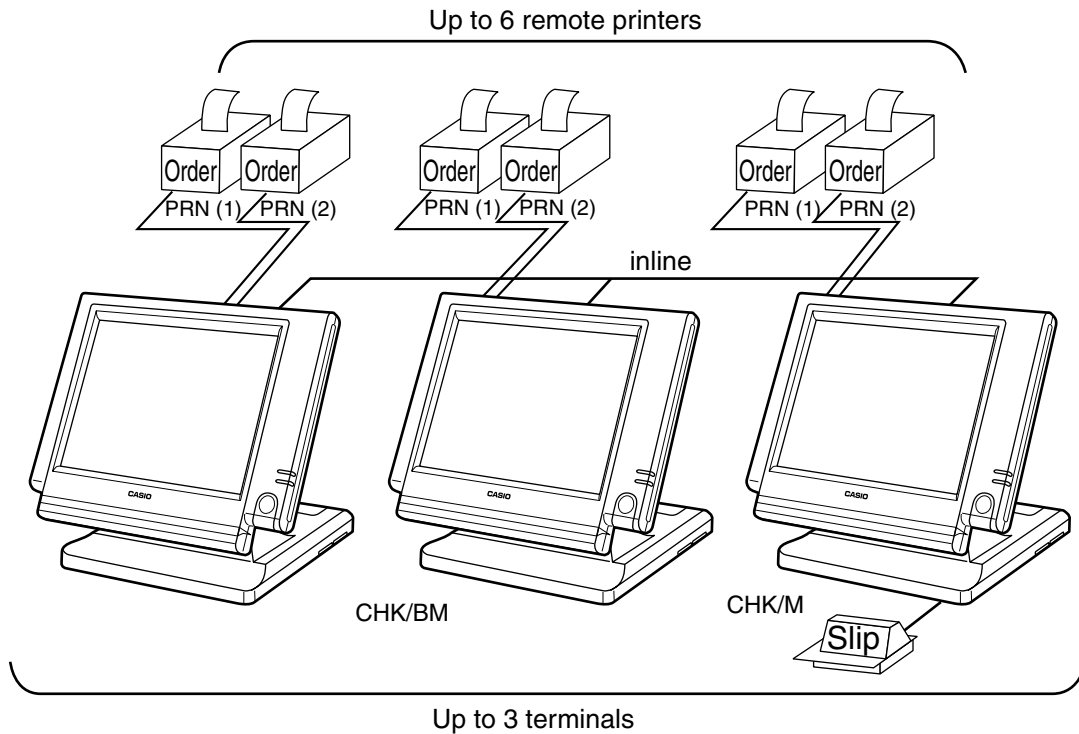

Shared check tracking is performed as shown in the figure shown above.

- ① A shared check operation (such as "new check" or "old check" etc.) is made at a terminal.
- ② The terminal sends the check number to the check tracking master and the backup master. The master and backup master turn on the busy status.
- ③ The master sends back the check data (if the check number exists) or opens a new check number.
- ④ A shared check transaction is finalized (by "new balance" or other finalize key).
- ⑤ The terminal sends the check data to the master and the backup master. And the master/backup master clears the busy status of the check number.

2-4-2. Shared check tracking requirement

The following definition of memory allocation is required in each terminal before you can perform shared check tracking.

- Number of check tracking tables:
For satellite, minimum one, for master, more than the number of estimated open checks should be defined.*

* In case of using the next block **, one more check tracking table is consumed.

- Number of items/tables (per one item block **):
This is not the maximum number of items or functions but the number ordinarily registered items or functions per one table. If the number of items or functions exceeds this value during registration, the next block is used automatically for the following transactions.

** Number of item blocks:

Ordinarily, the registration requires one item blocks—but in a party for example—more items are registered per one table. So it is necessary to define how many item blocks can be used.

The maximum number of items or functions per one check is defined by the formula:
= (Number of items / tables) × (Number of item blocks (1 ~ 10))

When memory near end and memory end happens during registration, an error occurs. See section A-5. Error messages of this manual.

2-4-3. Data backup when the master goes down

When the system has the backup master for the check tracking system, registered check tracking data are stored both master and backup master automatically.

As soon as the system detects master down, the backup master roles as master for the check tracking system.

(It is necessary to switch to backup master manually. See the “System down & Recovery” chapter on page 9 of the installation & down recovery manual.)

When the system has no backup master for the check tracking system or both master and backup master become down, no more check tracking operation and clerk interrupt operation can be made.

2-5. Other check tracking system control

2-5-1. The timing to clear check detail and index file after finalization

There are two timings to clear detail and index files.

1. The check is cleared after printing finalized data on slip or guest check receipt, or the check is also cleared when the new or old check operation is made on the terminal finalized the transaction.
2. The check is cleared after printing finalized data on slip or guest check receipt, or the check is also cleared when the same finalized check number is assigned in new check operation.

This option is set on the page 40 of the programming manual.

2-5-2. Table transfer

This function is used for transferring the contents of a check to another check. The detail data can be excluded from the transferring check by programming (ST transfer). There are two cases depends on the status of the transferring check.

1. If the transfer check is not used.
The entered check number is written.
2. The check number is already used.
Add the contents to the existing contents.

This option is set on the page 86 of the programming manual.

2-5-3. Store and recall

These functions are used for the driving through purchase. The check number used in store operation is defined by check No. range programming.

2-5-3-1 Store

This function is used for storing the check No. of the registered items. The Detail / Index at the drive-through entrance record the registered items and store it's check No., and then print out the temporary receipt. A customer receives this temporary receipt, and drives up to the exit with this to receive the ordered item. The stored data transfer to the check tracking master/backup master.

2-5-3-1 Recall

This function is used for recalling the transferred check No. to total the sum. The terminal at the drive-through exit recalls transferring check No. in order of the oldest record. A customer can receive the ordered items, and pay for them.

Application System

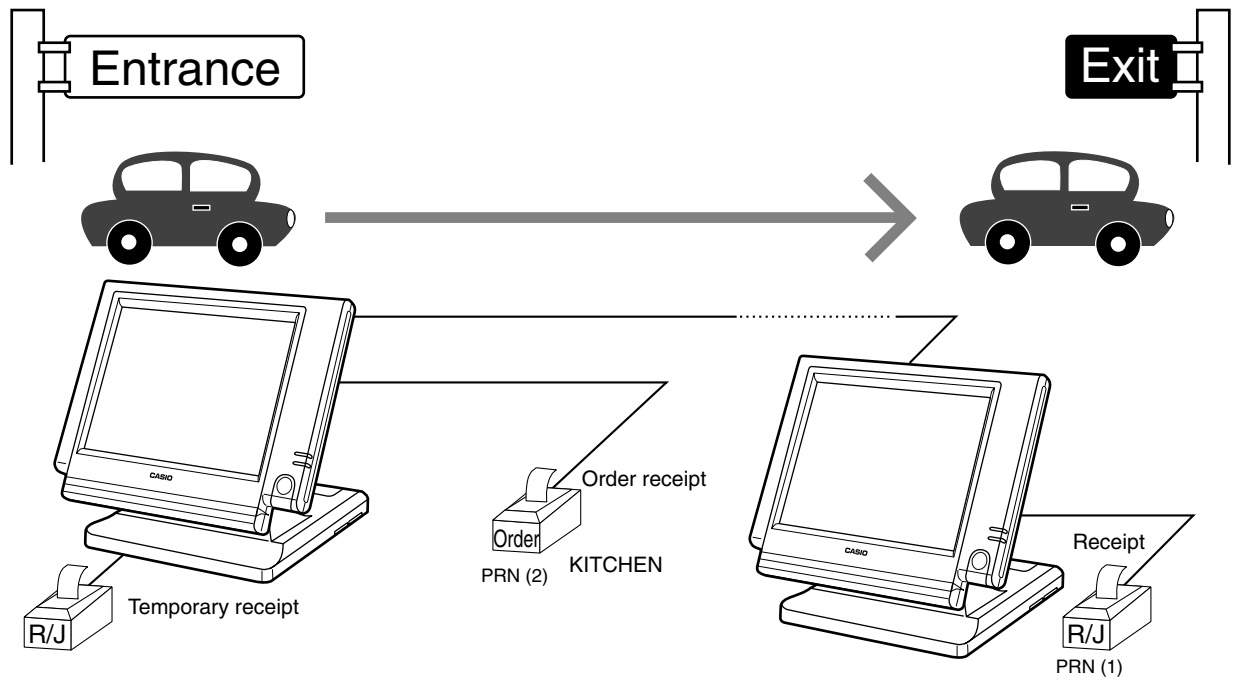

Store

Hamburger
French Fries
Hot Coffee
Press the <STORE> key → [CHK No.100

Cheese Burger
Orange Juice
Press the <STORE> key → [CHK No.101

Recall

Press the <RECALL> key → [CHK No.100

Hamburger
French Fries
Hot Coffee

Press the <RECALL> key → [CHK No.101

Cheese Burger
Orange Juice

1. Without entering new check No., register items. After all ordered item have been registered, press the <STORE> key at the entrance to summarize the registered items. The check No. is issued automatically. The contents of these check No. transfer to the check tracking master / backup Master.

2. Press the <RECALL> key to recall the check at the exit.

Important

- A four-digit check No. should be used.
- When Open Check Z (All) report is printed out, the check No. range will be reset. After this operation, the next check No. by using Store function will be the range start.
- This function works with the option "Clearing CHK/TBL No. by using the same number again" to "Check number" only. (Refer to page 40 of the programming manual)

2-6. Clerk control function

2-6-1. Clerk interrupt

The terminal can be programmed to allow the clerk interrupt function, which makes it possible for multiple clerk to simultaneously use the same register. If a clerk starts registration of a transaction, another can be interrupt the original registration and begin a new one. The original clerk can later resume the interrupted original registration. You can use the clerk interrupt function with the check tracking function.

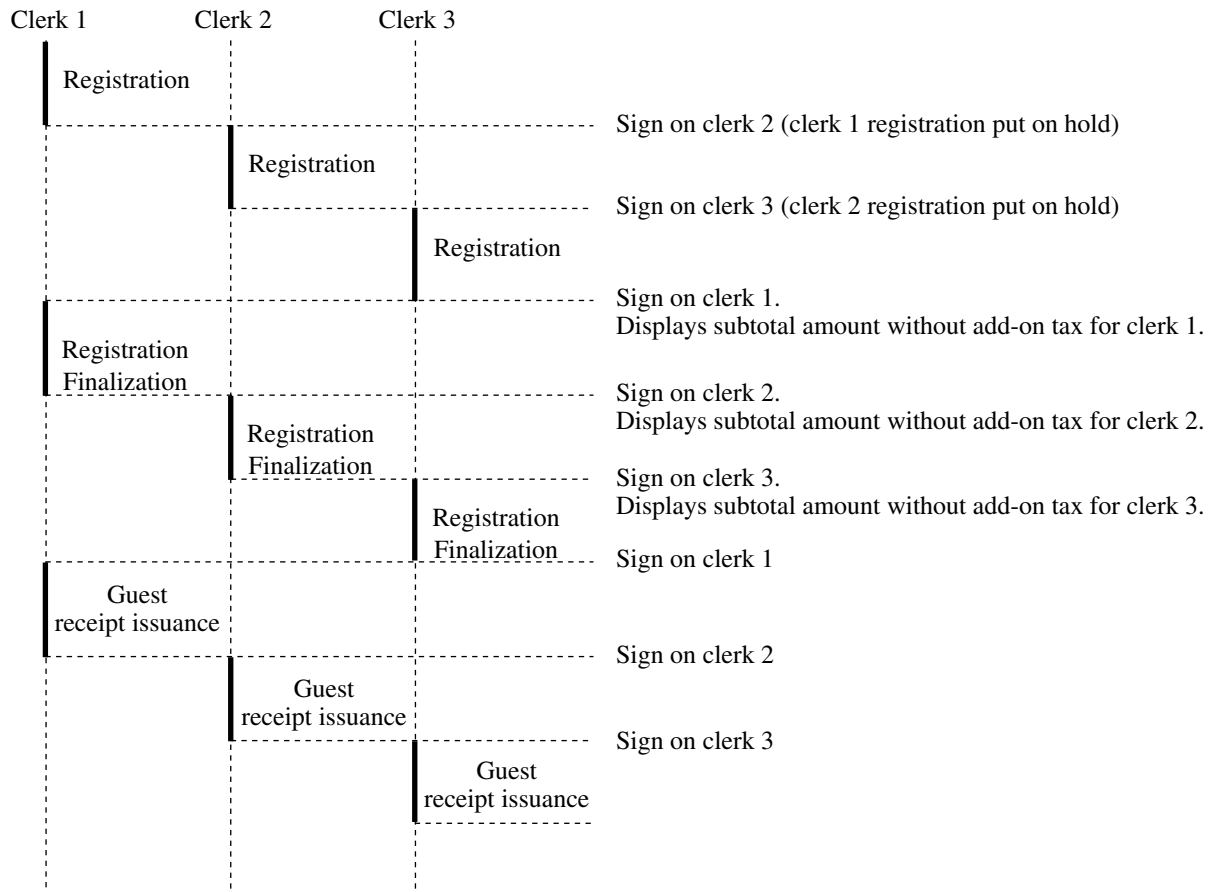

Notes

- 1) Error correct operation
The error correct operation cannot be performed for registrations made before a clerk change. The error correct operation should be performed before clerk change.
- 2) Guest receipt
A guest receipt can be issued following clerk change, and receipts can be issued separately for each clerk.
- 3) Cancel operation
The cancel operation can affect the entire transaction (multiple receipts: complete cancellation) or only the same transaction (one receipt) by programming the <CANCEL> key.

Application System

2-6-2. Clerk detail memory

The terminal can summarize any daily / periodic total memory (such as fixed totalizer, department, PLU, etc.) clerk by clerk.

After initialization, clerks have 10 detail memories which are assigned to gross, net, and 4 media in drawers. If you want to set more detail memories to clerks, allocate clerk detail memory and detail link memory at the same time.

Clerk detail memory: File 011 / 111 / 211 / 311 / 411 / 511 / 611

Clerk detail link: File 030

2-6-3. Clerk training

Clerk training can be performed when employing new clerks or retraining clerks.

Training is normally performed during working hours, and the QT-6100 has the following training functions.

- 1) It is not necessary to remove one terminal from the system for training purpose during working hours.
- 2) Programming options, etc., are controlled exactly the same way as a working clerk.
- 3) Receipts are different from those normally used. The training receipts are filled with training filler (“*” default.)
- 4) Only the REG/REF/REG- mode can be used for training.

2-6-4. Manager mode control

There is no actual REG 2 mode on the terminal, but you can control some functions (you want) under manager control.

Preparation for this function:

- 1) Set “NO” to any functions you want to disable for CLERKS in the Allowed function 1 ~ 5 list in the clerk programming. (See page 71 ~ 73 of the programming manual.)
- 2) Set the type of operator to “Manager” for the manager. (See page 64 of the programming manual.)

Operation for this function:

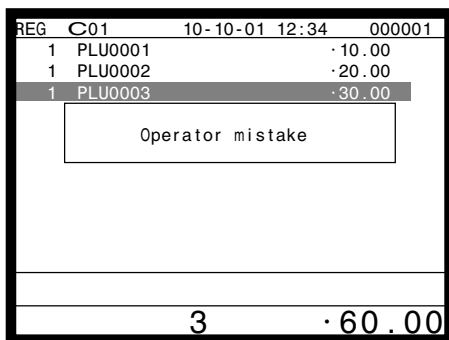

1. When the transaction is prohibited, the terminal displays error message and the clerk calls the manager.

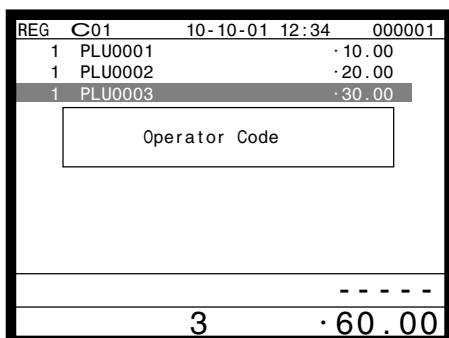

2. The manager enters “2” and press the <REG MODE> key.

REG	C01	10-10-01 12:34	000001
1	PLU0001		·10.00
1	PLU0002		·20.00
1	PLU0003		·30.00
REG2 Mode			
			0.00
3			·60.00

3. The manager enters his/her secret code and press the <YES> key. After this operation, the prohibited transaction can be registered.

REG	C01	10-10-01 12:34	000001
1	PLU0001		·10.00
1	PLU0002		·20.00
PLU0003			-30.00
2			·30.00

4. Perform manager operation (in this example; void operation).

REG	C01	10-10-01 12:34	000001
1	PLU0001		·10.00
1	PLU0002		·20.00
REG Mode			
			0.00
2			·30.00

5. Pressing the <REG MODE> key is required, when the manager returns his/her office.

2-7. Arrangement key function and scheduler

The arrangement key function provides a macro command function for the QT-6100 system. Any operation that can be performed using the keyboard of the QT-6100 can be programmed to the arrangement file (file 038 ~ 438). Any operation programmed to the arrangement file can be performed by pressing the arrangement key (function code 044). Multi operations can be programmed into one arrangement program, and also entry of a numeric parameter can be included anywhere in the arrangement program.

For example, when an arrangement program is programmed for executing fixed totalizer Z consolidation for all terminal and the program is linked to an arrangement key, that operation can be executed simply by pressing the arrangement key or attaching the i-Button key to the receiver.

The scheduler function is provided for scheduled execution of arrangement key operation. Execution of every specified time, as well as scheduled execution, can be performed using this function.

The scheduler file (file 062) must be reserved to use the scheduler function.

2-7-1. Arrangement key function

The arrangement file and arrangement keys must be reserved for the QT-6100 to use the arrangement key function.

The arrangement file is used to store the arrangement programs. An arrangement file record is 24 bytes long, and a maximum of 9999 records can be reserved. Arrangement programs are programmed using character data, and multiple arrangement programs can be programmed in the arrangement file.

Multiple arrangement keys can be preset on the keyboard, and each key can be linked to an arrangement program. The linked arrangement program is then called and executed by pressing the arrangement key.

The following table shows the command parameters of the arrangement key function that can be interpreted and executed by the QT-6100.

Command parameters can only be separated by spaces.

Note that spaces cannot be included within the command parameter.

Details of command parameters and their functions are explained next.

1) Number input

There are two methods to enter a number in an arrangement program.

– Constant number input

Preset a fixed number (constant value) enclosed in parentheses in the arrangement program.

Example: To enter “1234” → preset (**1234**)

– Input of a single number when the arrangement program is executed.

A single number can be entered using the arrangement key. The number entered can be used at any position and any time in the arrangement program.

Generally, an input number is temporarily stored in the work area (number entry buffer) reserved for data processing, and is cleared after the processing is performed. With the arrangement key function, a parameter save buffer is provided for saving the contents of the number entry buffer. When a “%GET” command is encountered in an arrangement program during processing, the data in the number entry buffer is saved to the parameter save buffer. Set “%PUT” command to use the data saved in the parameter buffer. The “%PUT” command can be used to load the data saved in the parameter save buffer into the numeric entry buffer. These commands may be included as often as necessary. The data in the parameter save buffer is changed only when a “%GET” command is processed.

Note:

- Set a “%GET” command, first, to use the number entered by the arrangement key later.
- When the “%GET” is programmed following constant number input, the constant number is saved to the parameter save buffer.
- Numbers input using a “%PUT” command or by “([number])” are entered to the number entry buffer in the same way as numbers input using the 10-key pad.

2) Key function specification

Any function key can be specified for an arrangement key function. :

[function code]:[record number] → Used for ordinary function keys

The numbers can be specified for zero suppression.

Note:

The arrangement key itself, cannot be programmed for in an arrangement program.

3) Mode setting

Any mode key can be specified for an arrangement key function. :

[function code]:[mode definition]→ Used for mode keys

Note:

121:01	: REG mode
121:02	: REF mode
121:03	: REG- mode
122:01	: X/Z mode:
122:02	: MGR mode:
122:03	: Collection/Consolidation mode:
122:04	: Auto-program mode:
122:05	: CF card:
123:01	: PGM1 mode:
123:02	: PGM2 mode:
123:03	: PGM3 mode:
123:04	: PGM4 mode:
123:05	: PGM5 mode:
123:06	: PGM6 mode:

4) Print control

There are two commands for controlling the printer:

PON	: Output printout data.
POFF	: Not output printout data.

5) Controlling the flow of arrangement command execution

There are 31 commands for controlling the flow of arrangement command execution:

:Snnnn : This is a start mark of an arrangement. “nnnn” (4-digits code) are used for arrangement table number set to each arrangement key.

(nnnn) : “nnnn (no digit limitation)” means numeric entry.

NN:nnnn : “NN” is a function code which is executed in this arrangement, “nnnn” is the record No. of the function.

:[label] : Preset the label (name of specific position) to specify the jump destination point in the arrangement file. The actual data for labels can be freely designated.

Example: To specify “LABEL-1” as label → :LABEL-1

G:[label] : This is an absolute jump command. If the system encounters this command, command execution flow unconditionally jumps and continues from the point preset by the label.

I > ([number]):[label] : This is a conditional jump command. If the system encounters this commands, the value in the number entry buffer is compared with the specific number. If the value in the buffer is larger than the specified number, the command execution flow jumps and continues from the point preset by the label. If the condition is not match with the above-mentioned condition, the step advances to the next command.

I < ([number]):[label] : This is a conditional jump command. If the value in the number entry buffer is less than the specified number, the command execution flow jumps to the point preset by the label. If the condition is not match with the above-mentioned condition, the step advances to the next command.

I – ([number]):[label] : This is a conditional jump command. If the system encounters this command, the value in the numeric entry buffer is compared with the specific number. If the value in the buffer is equal to the specific number, the command execution flow jumps and continues from the point preset by the label. If the condition is not match with the above-mentioned condition, the step advances the next command.

KNO1 : This is a command to enter the <#-1> key.

KNO2 : This is a command to enter the <#-2> key.

NE : This is a command to wait for numeric entry. After entering numerics, press the <ARRANGEMENT> key to continue the arrangement program.

?	: Force to execute the arrangement even if an error occurred during the arrangement.
ANO	: Disable clerk auto sign-off.
AYES	: Enable clerk auto sign-off.
CFFMT	: Format CF card.
CFSVnnn'mmmm'	: Backup to CF card (nnn: command code, mmmm: file name).
CFLDnnn'mmmm'	: Restore from CF card (nnn: command code, mmmm: file name).
JCL	: Clear electronic journal older half data
JCLA	: Clear all electronic journal data
CLPn	: Set the default @ menu sheet number to "n" (n = 0 ~ 2) and "stay down @ menu sheet assignment" of all clerk.
CLMn	: Set the default menu sheet number to "n" (n = 0 ~ 15) and "stay down menu sheet assignment" of all clerk.
CLSn	: Set the default shift PLU level number to "n" (n = 0 ~ 8).
211:	: Press the "ESC" key.
212:	: Press the "YES" key.
213:	: Press the "NO" key.
%GET	: Read from key buffer.
%PUT	: Write to key buffer.
CLL0n	: Set the default clerk pop-up window number to "n" (n = 0 ~ 9).
!:sss	: Wait the next step for "sss" (ss = 001 ~ 327) sec.
F:m:nn	: Sending data (designated by "nn") to the terminal (designated by "m") via FTP. "m" means the rec-# of file-912, "nn" means the rec-# of file-913

6) End of the arrangement programs

The end command "E" must be included at the end (exit) point of an arrangement program.

2-7-2. Arrangement program example

This section shows examples of arrangement programs.

The following example shows an arrangement program that executes X consolidation of the file set in the batch 1 ~ 9 files for all terminals.

Example:

Programming the following operation for the arrangement table 12

- Set the mode to Inline X/Z.
- Enter operation code "1111100000000".
- Wait for the numeric entries (batch number).
- Enter the <#-2> key.
- Enter the <ESC> key.

```
:S0012           ;Designate the table number (mandatory)
122:03          ;Set the mode to Inline X/Z.
NE              ;Wait for the batch number
I<(0):ERR1      ;If the input number is less than 1, the process jumps to the ERR1.
I>(9):ERR1      ;If the input number is larger than 10, the process jumps to the ERR1.
%GET           ;Save the entered number to the parameter save area.
202:0031        ;Press "Clear" button.
(1111100000000) ;Input the operation code for system command
%PUT           ;Pick up the entered number from the parameter save area.
KNO2           ;Specify the <#-2> key for entering the operation code.
211:0045        ;Specify the <ESC> key to execute this operation.
:ERR1          ;When the input number is not 1 to 9, the following commands are
                  processed.
E              ;End the program (mandatory).
```

2-7-3. Scheduled execution of arrangement key function

An arrangement key function can be executed on a scheduled basis. In order to execute an arrangement key function on a scheduled basis, it is necessary to make appropriate settings in the scheduler file (file 062).

There are two functions for execution on a scheduled basis:

- 1) Execute an arrangement key function at the specified time.
- 2) Interval execution of an arrangement key function by setting start time, ending time, and the interval.

See the page 42 of the programming manual for programming details.

2-8. Making graphic logo

A graphic logo can be printed on internal receipt or UP-360 receipt. This graphic logo is stored in the graphic logo file (file 047 for UP-360), and printed at the top of the receipt instead of a normal logo message.

This graphic logo data cannot be made by the terminal program, it can be made only by PC and downloaded from PC.

2-8-1. About graphic logo

Graphic logo size: 432 × 104 or 432 × 208 pixels

Printing sample:

```
*****  
* QT-6100 TERMINAL *  
*          GRAPHIC LOGO AREA *  
*****  
  
*****COMMERCIAL MESSAGE LINE 1*****  
*****COMMERCIAL MESSAGE LINE 2*****  
*****COMMERCIAL MESSAGE LINE 3*****  
*****COMMERCIAL MESSAGE LINE 4*****
```

2-8-2. Making graphic logo procedure

Before following this procedure please allocate “Graphic logo” file (file 047) on the terminal.

1. Making a bit-map image file:
(432 × 104 or 432 × 208 pixels; 1-bit color for UP-360).
2. Convert this bit-map file to the internal file by executing such PC software as CV.
PC sends the converted data to the terminal via online automatically.
3. Select “Print Graphic” option in the message control of the general feature in the PGM 3 mode.
4. Turn off and on the terminal by the <DISP ON/OFF> button.

2-9. Hourly item

This function enables to memorize the detailed data of quantity and amount / price of each item dealt hourly.

It is possible to calculate the proceeds and record the hourly item in any totalizer, and also it is possible to print out as an hourly item report.

2-9-1. Programming necessary files before using hourly item function.

Hourly item function requires the following files to function properly, so they must be programmed before using it. See the programming manual for the details on format of individual files.

– Time zone file

This file is used to specify the time zone for the detail items individually. You can enter the starting time and the ending time of the time zone, moreover specify the cycle time that indicates an unit of the appropriate intervals.

– Hourly item link file

This file is used to record the Hourly item which links with the appropriate time zone. You can also specify the particular totalizer for each time zone.

– Hourly item

This file is used to store the contents of the quantity and amount of each registered item.

The following seven files enable to link the data for hourly item link file: fixed totalizer, function, subdepartment, PLU, department, group, void reason.

Hourly item report example

08:00->09:00		
Hamburger	2	\$2.00
French Fries	3	\$1.50
		\$3.50

09:00->10:00		
Cheese Burger	2	\$3.00
Hot Coffee	2	\$0.50
		\$3.50

:		
13:00->13:15		
Apple Pie	1	\$1.00
Hot Milk	1	\$1.00

Time zone file

	Start Time	End Time	Cycle
Zone	08:00	12:00	01:00
	13:00	14:00	00:15
	.	.	.
	.	.	.

Hourly item link

REC No.	File No.
0001	004
0011	001
.	.
.	.
.	.
.	.
.	.
0005	012
0008	012
.	.
.	.
.	.
.	.

A maximum of 20 records corresponds to each time zone.

2-10. Time and attendance

This function allows shop owners to control his / her employees' working condition. Time & attendance require the following files.

– Employee file

This file is used to regulate the labor conditions.

You can program the type of job, the maximum work hours in a week or shift schedule of a day per employee.

– Job code file

This file is used to classify the types of job. You can program the general work pay and the overtime pay ratio per job file.

If some employees have a common job, you can divide the job code individually in case their pay ratio is different.

– Schedule file

This file is used to administrate the employees' schedule. You can assign a starting and an ending time, a grace period, break minutes allowed, and the default job code for the shift. It is possible to record maximum 21 shifts (3 shifts × 7 days) per employee for the schedule file.

Grace period – this is a period of time in minutes which allows an employee to clock-in / out before / after their scheduled times. Grace period works in conjunction with the schedule. If the scheduler is not being utilized then the grace period inputs indicated below become inactive.

Grace period before start time – this input indicates how many minutes an employee may clock-in before the scheduled clock-in time.

Grace period after start time – this input indicates how many minutes an employee may clock-in after the scheduled clock-in time.

Grace period before end time – this input indicates how many minutes an employee may clock-out before the scheduled clock-out time.

Grace period after end time – this input indicates how many minutes an employee may clock-out after the scheduled clock-out time.

(See “4-1-15. Programming time & attendance” for the programming manual.)

		Job Code	Start Time	End Time	Break Time	Grace Before Start	Grace After Start	Grace Before End	Grace After End
Monday	Shift	1	9:00	12:00	00:15	10	10	5	15
	Shift	5	13:00	15:00	00:15	10	10	5	15
	Shift	2	16:00	18:00	00:15	10	10	5	15
Tuesday	Shift	3	9:00	12:00	00:15	10	10	5	15
	Shift	2	13:00	15:00	00:15	10	10	5	15
	Shift	4	16:00	18:00	00:15	10	10	5	15
Sunday		•	•	•	•	•	•	•	•
		•	•	•	•	•	•	•	•
		•	•	•	•	•	•	•	•

Each employee can have 3 shifts per day. The schedule file can hold 7 days schedule. So, totally 21 files can be registered in this file.

Application System

– Work time file

This file is used to administrate each employees' weekly hourly wages, work hours, and proceeds.

– Time zone file

This file is used to administrate the cycle time. You can specify the length of time zone.

2-10-1. Corresponding relations of the file

Employee's job assign

This function is used to assign a job to each employee. Before assigning the job, be sure to program the details of the jobs. Every employee file can link to some job code files (maximum 4 jobs), so some employees may link to the same job code file. But be sure to make individual job files if the employees work under different hourly wages.

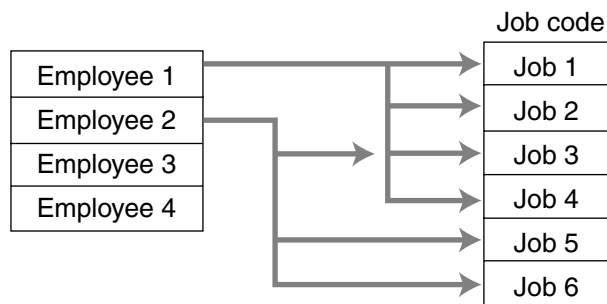

Employee's Schedule and total business results per week

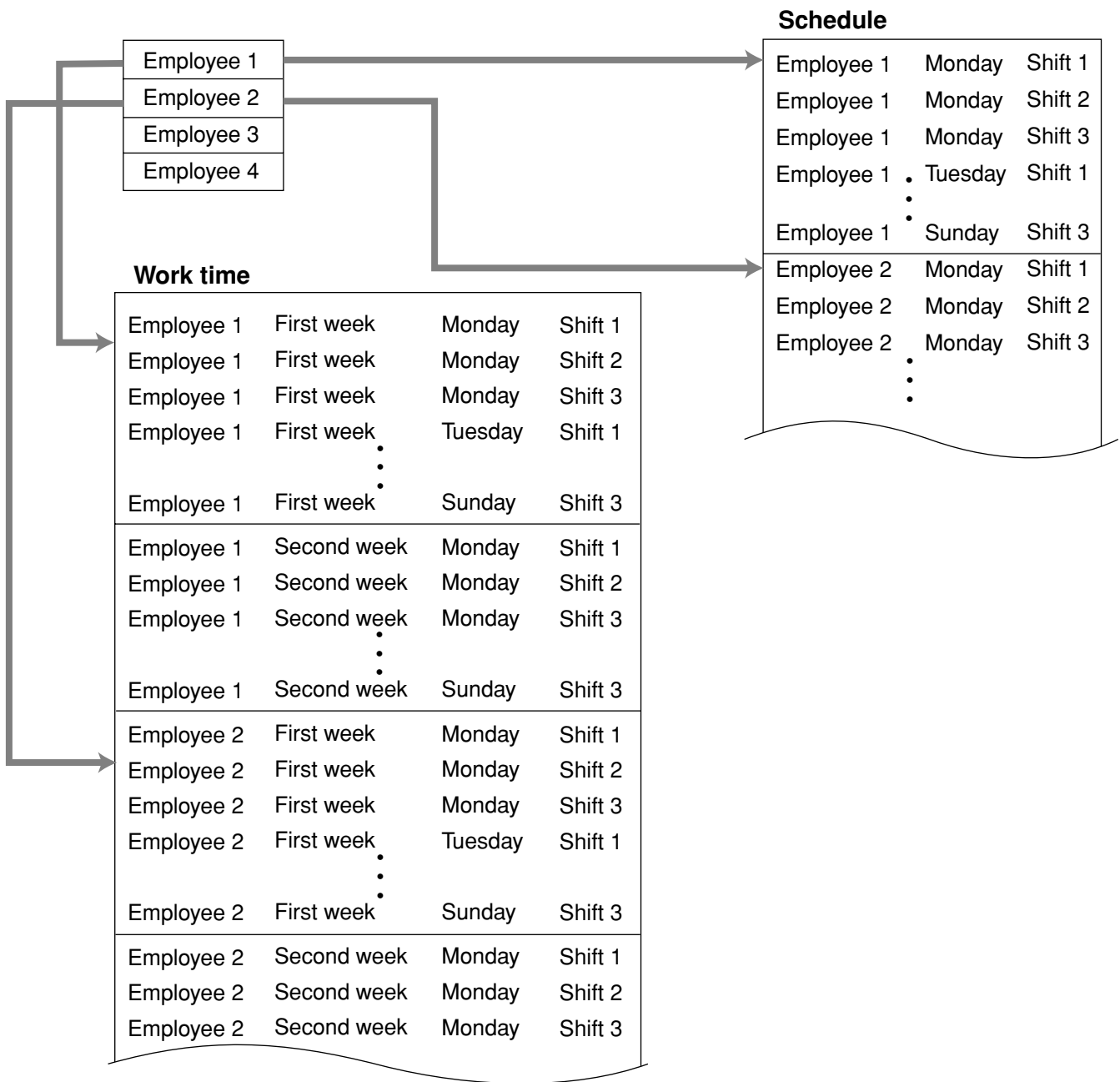

Application System

Calculating the total wages of the employees per hour

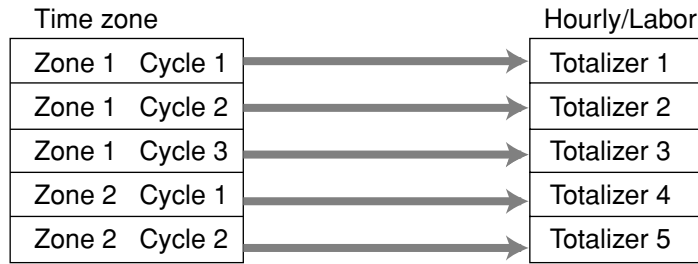

Flow of Time & Attendance operation

The following flow shows the order of time & Attendance function by pressing the specified keys: It is possible to specify one key as both <CLOCK-IN> and <CLOCK-OUT> function, or specify two keys separately. (Refer to “4-3-7-33 Worksheet for clock-in/clock-out” in the programming manual for details.)

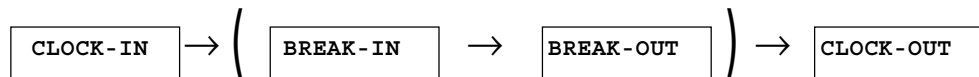

2-10-2. Clock-in operation

This function is used to register the Starting work time.

2-10-2-1. Clock-in operation (1)

Program: Not using the window and impossible to specify job code.

Allow to specify job code = NO, Display job code window = NO
 (Refer to the page 54 of the programming manual.)

Operation

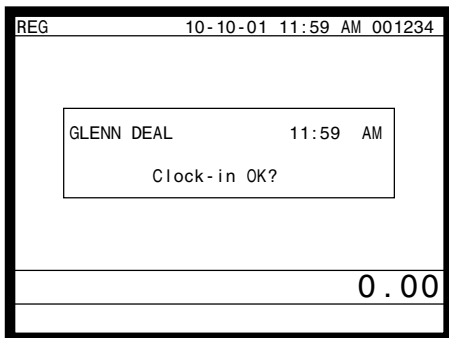

1. XXXXXX <CLOCK-IN>

When this message appears, press the <YES> key to register the start of working hours.

XXXXXX
 └───┘
 Employee No.

2-10-2-2. Clock-in operation (2)

Program type:

Allow to specify job code = YES, Display job code window = NO
(Refer to the page 54 of the programming manual.)

Operation

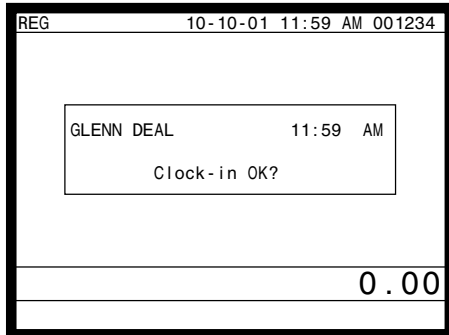

1. XXXXXX . YY <CLOCK-IN>

When this message appears, press the <YES> key to register the start of working hours.

Enter the employee No. (within 6 digits), “.”(decimal point), and the job code (2 digits).

XXXXXX . YY

Employee No. Job code

2-10-2-3. Clock-in operation (3)

Program type:

Display job code window = YES

Allow to clock-in with non-preset job-code = NO

(Refer to the page 54 of the programming manual.)

Operation

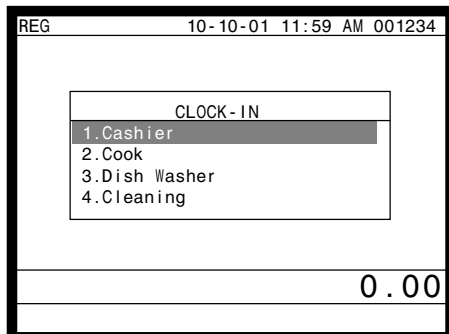

1. XXXXXX <CLOCK-IN>

2. Choose the appropriate Job Code from the CLOCK-IN menu, and press the <YES> key to register the start of working hours.

→ Job codes that are programmed in Employee file are displayed.

XXXXXX

Employee No.

Application System

2-10-2-4. Clock-in operation (4)

Program type: Display job code window = YES
Allow to clock-in with non-preset job code = YES
(Refer to the page 54 of the programming manual.)

Operation

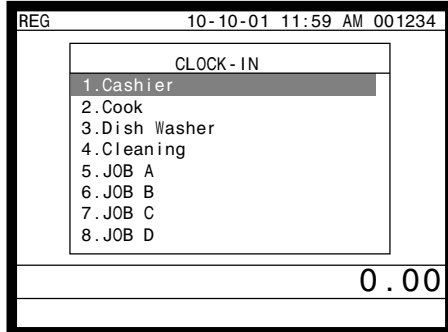

1. XXXXXX <CLOCK-IN>
 2. Choose the appropriate Job Code from the CLOCK-IN menu, and press the <YES> key to register the start of working hours.
- All job codes that are programmed in job code file are displayed.

XXXXXX
Employee No.

Receipt sample

REG C01	12-31-2005 11:59 AM 001234	MC #01	Header
Harrison			Employee character (16 digits)
CLOCK-IN	11:59 AM		Special character (REC #29), time
JOB Dish Washer			Special character (REC #33), job character

If you want to change these special characters, refer to the page 112 of the programming manual.

2-10-3. Clock-out operation

This function is used to register the ending work time.

2-10-3-1. Clock-out operation (1)

Operation

```
REG 10-10-01 11:59 AM 001234
GLENN DEAL 11:59 AM
Clock-out OK?
0.00
```

1. XXXXXX <CLOCK-OUT>.
2. When this message appears, press the <YES> key to register the end of working hours.

2-10-3-2. Clock-out operation (2)

Program: Tip declaration compulsory (refer to the page 53 of the programming manual.)

Operation

```
REG 10-10-01 11:59 AM 001234
Enter cash tip amount and
press <YES> key.
0.00
```

1. XXXXXX <CLOCK-OUT>.
2. When this message appears, the employee should enter the cash tip amount, if not, it is impossible to close the accounts

Receipt sample

REG C01	12-31-2005 11:59 AM 001234	MC #01	Header
Harrison			Employee character (16 digits)
CLOCK-IN	11:59 AM		Special character (REC #29), time
JOB Dish Washier			Special character (REC #33), job character
CLOCK-OUT	01:59 PM		Special character (REC #30), time
WORK TIME	02:45		Special character (REC #34), working hours
BREAK TIME	00:45		Special character (REC #35), recess
CASH TIP	\$12.34		Special character (REC #36), cash tip amount

If you want to change these special characters, refer to the page 112 of the programming manual.

Application System

2-10-3-3. Break-in operation

This function is used for the employees to register a recess.

Operation

REG	10-10-01 11:59 AM 001234
GLENN DEAL 11:59 AM	
Break-in OK?	
0.00	

1. XXXXXX <BREAK-IN>.
2. When this message appears, press the <YES> key to register the start of a recess.
The receipt is not printed out, except electronic journal.

2-10-3-4. Break-out operation

This function is used for the employees to register the end of a recess.

Operation

REG	10-10-01 11:59 AM 001234
GLENN DEAL 11:59 AM	
Break-out OK?	
0.00	

1. XXXXXX <BREAK-OUT>.
2. When this message appears, press the <YES> key to register the end of a recess.
The receipt is not printed out, except electronic journal.

2-10-3-5. Manager operation

When the manager operate CLOCK-IN after signing on, the manager can operate and modify any employee's record despite of corresponding employee number.

Following operations are possible to operate by the manager:

Specify the job code / CLOCK-IN / CLOCK-OUT / BREAK-IN / BREAK-OUT

Operating Flow

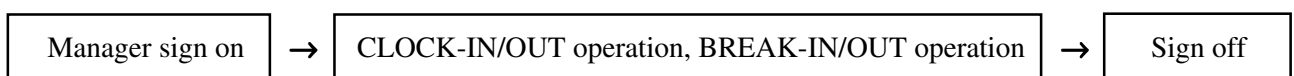

2-11. Sign on control

This function is used to prohibit the sign-on operation by an employee who has not CLOCK-IN. The following conditions should be fixed.

- Use only one terminal (master terminal) for the CLOCK-IN/OUT operation. This terminal should be connected inline to the satellite terminals. But the time and attendance work file (file 806) should be allocated to all terminals.
- The clerk file's information should be common among all the terminals.
- Be sure there is a clerk who is specified as "Manager" in the clerk file. If no manager, it may be locked to operate.

2-11-1. Sign on

1. When an employee normally operate CLOCK-IN/OUT, BREAK-IN/OUT, the employee's attendance information is sent from the main terminal to the satellite terminals.

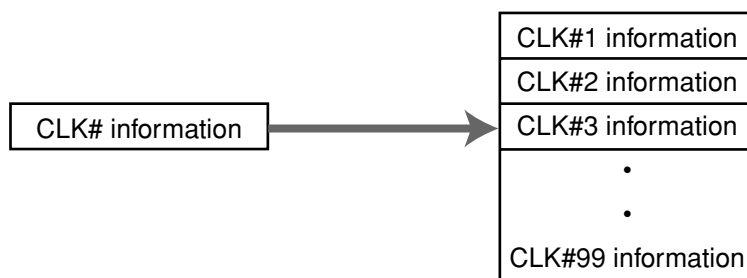

Flow of sign on

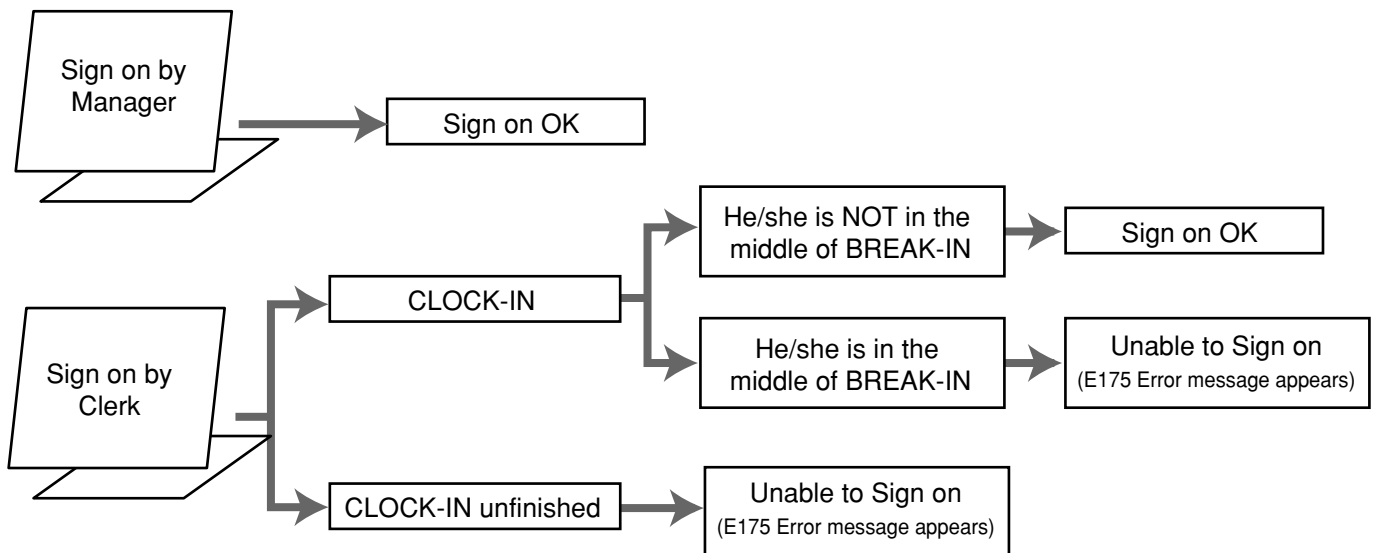

Application System

2-11-2. Solution to abnormality of master terminal

When the satellite terminals cannot receive any information from the master terminal, the master terminal shows the error message on the window and prints out the receipt with terminal IDs that failed to communicate the data.

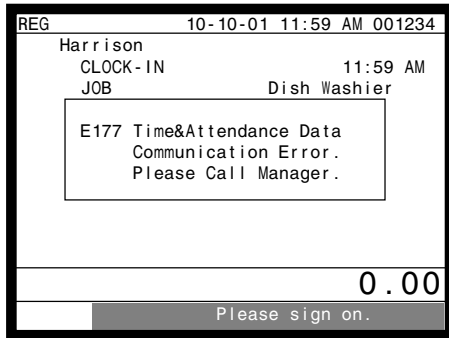

Receipt image

REG C01	12-31-2005 11:59 AM 001234	MC #01	Header
Communication Error		XXXX	Fixed message
	MC#01	XXXX	Machine ID, Error code
	MC#03	XXXX	Machine ID, Error code

- The error message and receipt will appear whenever the sign-on is failed. If you cannot solve the inline data communication problem, program the system connection again, and remove the uncommunicative terminal.

2-11-3. Solution to abnormality of satellite terminal

- When the satellite terminal cannot receive any information from the master terminal, the default CLOCK-IN/OUT information remain.
In this case, only manager can sign on.
- When the satellite terminal could receive the CLOCK-IN/OUT information from the master terminal only once, but failed to receive after then, the CLOCK-IN/OUT information in each satellite terminal has left in the last received condition. In such case, the last received information control employees' sign on/off. (Manager can always sign on.)

2-11-4. Sign on compulsory

When the satellite terminal cannot receive the information in spite of normal CLOCK-IN operation on the master terminal, an employee may not sign on for some reason. In such case, the manager needs the following operation.

1. Sign on by the manager (normal sign on operation.)
2. 99 xxxx <CLK#> (xxxx: the secret code of the corresponding employee, 4-digit.)
3. Sign off by the manager and the corresponding employee can sign on.

Note:

When the error message appeared under the employee's CLOCK-IN operation, manager should operate above steps.

2-12. IDC (Item Data Capture)

This function is used for capturing all the registered item data by the REG / REF / REG–modes. IDC file stores these captured items. If there is no record to capture item data, the new data are not captured to the IDC file.

2-12-1. Available capturing items

Select the appropriate items that should be captured, and program these items into the IDC link file. The available items and their contents are indicated below.

Items	Contents	File No.
PLU	<ul style="list-style-type: none">• The index of the transaction.• The report of the items/functions, or all the detailed statements.	004
Subdepartment		003
Department		005
Function		002
Pulldown group		026
Clerk	<ul style="list-style-type: none">• The index of the transaction.• The report of all the detailed statements.	007

Application System

IDC function file

	Function		Code			Function		Code			Function		Code	
	NOP		000	—		Price		049	—		Substitution		111	—
●	Cash amount tendered		001	○	●	Department		051	○		Ketten Bon	*1	113	○
●	Charge		002	○		Slip back feed/Release		054	—		House Bon	*1	114	○
●	Check		003	○		Slip		055	—		Post entry		115	—
●	Credit		004	○		Slip feed/Release		056	—		Round repeat		116	—
●	Food stamp tender		005	○		Tax status shift	*1	057	○		Open check		117	—
●	New balance	*12	006	○		Table number	*5	058	○	●	Media change		118	○
●	EBT tender		007	○		Food stamp shift	*1	059	○		Seat number		119	—
	Price inquiry		008	—		Declaration		061	—		Display On/Off		120	—
	Stock inquiry		009	—	●	Tax exempt		062	○		Mode		124	—
●	Text recall	*11	010	○	●	Flat PLU		063	○	●	Eat-in		128	○
●	Text print	*11	011	○		Menu shift		064	—	●	Takeout		129	○
	Check print		012	—		Shift PLU	*1	065	○	●	Store		130	○
	Clerk transfer		013	—		Open		067	—		Recall		131	—
●	Table transfer	*10	014	○		Open 2		068	—	●	Subdepartment		133	○
●	Tip		015	○		First unit price	*1	069	○		Subdepartment number	*7	134	—
	Normal receipt		016	○		Second unit price	*7	070	○		Department number	*7	135	—
●	Loan		019	○		Clerk number	*5	072	○		List	*7	136	—
●	Received on account		020	○		Operator read/reset		073	—		List number	*7	137	—
●	Paid out		021	○	●	Tray total	*13	074	○		Dutch account		140	—
●	Pick up		022	○	●	Subtotal	*8	075	○		Customer No.	*5	148	○
●	Coupon		023	○		Receipt On/Off		076	—		Payment	*5	149	○
●	Deposit		025	○		Taxable amount subtotal		077	—		Numerics (0 ~ 9)		201	—
●	Minus		027	○		Operator number		078	—		Clear		202	—
●	Discount		028	○		Merchandise subtotal	*8	080	○		Reverse display		206	—
●	Plus		029	○		Food stamp subtotal		081	—		Electronic journal display		207	—
●	Premium		030	○		Multiplication	*1	082	○		Escape		211	—
	Refund	*1	033	○		Quantity/For	*1	083	○		Yes		212	—
●	Error correct/Void	*3	034	○		Square	*1	084	○		No		213	—
	Coupon 2	*1	036	○		Selective item subtotal	*2	085	○		Left arrow (←)		214	—
	Validation		037	—		Cube	*1	090	○		Right arrow (→)		215	—
	Receipt		038	—		New check		091	—		Up arrow (↑)		216	—
	Check endorsement		039	—		Old check		092	—		Down arrow (↓)		217	—
●	Non-add	*11	040	○		New/Old check		093	—		Home		218	—
●	Non-add/No sale	*4/11	041	○		Add check	*9	094	—		Display mode		219	—
	No sale		042	—		Separate check	*9	095	—		Page down		220	—
	No. of customer	*5	043	○		Two zero (00)		096	—		Page up		221	—
	Arrangement	*6	044	○		Three zero (000)		097	—	●	Cancel		236	○
	Currency exchange	*1	045	○		Decimal point		098	—		Item search		248	—
	VAT		046	—		OBR	*7	103	—		Order character change		252	—
	Bill		047	—		Clock-in/out		108	—		Location change		260	—
	PLU	*7	048	—		Break-in/out		109	—		Table sharing		261	—

● : Available items to be programmed as target for IDC.

○ : IDC target

— : Out of target

-
- *1 This function itself is not captured. But it is captured with the captured items or functions.
 - *2 Selective item subtotal is captured with selective item discount or premium.
 - *3
 1. Error correct is not captured.
 2. This function itself is not captured. But it is captured with voided items.
 3. Void reason is also captured.
 - *4 No sale is not captured.
 - *5 These functions (items) are captured in header record.
 - *6 This function itself is not captured. But the functions that are executed by this function are captured.
 - *7 This function is not captured. But item itself might be an IDC target.
 - *8 When the option (printed when the key is pressed) is selected, it is captured.
 - *9 Transferred items by the add check and the separate check are not captured.
 - *10 ST transfer is not captured.
 - *11 This function is captured only in the sales registration.
 - *12 This function is captured only in the check tracking registration.
During clerk interrupt operation, this is not captured.
 - *13 Tray total is captured when it is pressed twice.

Application System

2-12-2. Set up the IDC start / end

Specify IDC Start or IDC End in manager mode. IDC does not start if you not allocate necessary files for IDC.

- When IDC function is stopped, you can restart IDC by performing FC or INIT 2 (Refer to the page 10 of the programming manual.)

Operation

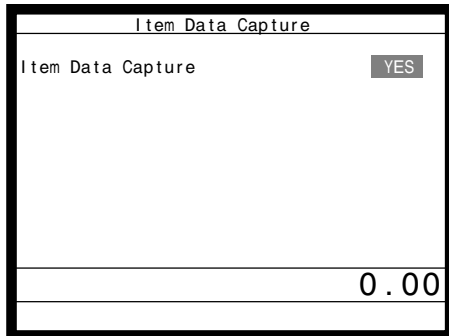

Item Data Capture	
Item Data Capture	YES
0.00	

Note:

1. If you stop the IDC when the IDC file is full of items, you can stop the error alarm without clearing any registered data.
2. The necessary files for IDC
 - File 036 (Registration buffer)
 - File 063 (IDC buffer)
 - File 057~ 059 (IDC file)
 - File 804 (IDC link file)

2-12-3. How to memorize the captured items

Flow of the transferring data

1. Program: "Store data = Whole transaction" (refer to the page 56 of the programming manual.)

Example

PLU 0001 —> Memorized all the transaction into the IDC file (1)

PLU 0002 —> Memorized into IDC file (2)

PLU 0003 —> Memorized into IDC file (2)

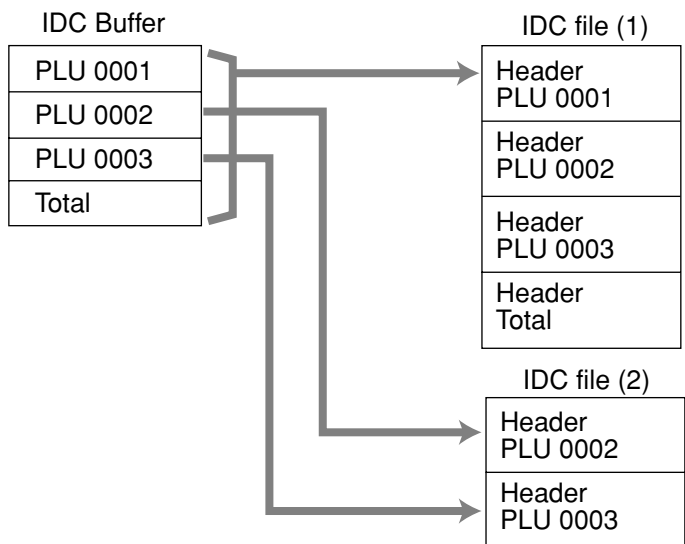

2. Program: "Store data = Item only" (refer to the page 56 of the programming manual.)
When an appropriate item is selected, this item and the header will be captured (see the illustration below).

Example

PLU 0001 —> Memorized into IDC file (1)

PLU 0002 —> Memorized into IDC file (2)

PLU 0003 —> Memorized into IDC file (2)

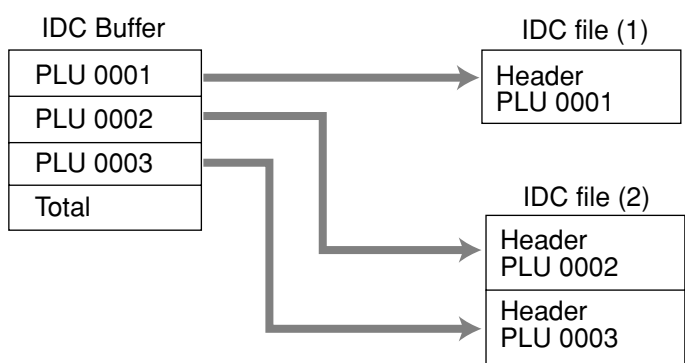

Application System

2-12-4. IDC data file structure

Top record (Top record of each IDC file)

0	12	24	50
Allocated record number	Used record number		

Header

0	1	2	8	11	13	16	19	21	26	31	36	41	47	48	50
Mc ID	01	Check-#	Consecutive No.	Mode	Clerk-#	Date	Time	Number of purchased item	Net total	Subtotal without tax	Subtotal with tax	Customer-#	Payment	Not Used	

Mode

D4:
D3: 01 = REG, 02 = REF, 03 = REG-
D2:
D1: 00 = Normal, 01 = Training

Clerk-#

D6:
D5: Clerk #; newly created this check
D4:
D3: Clerk #; last opened this check
D2:
D1: Clerk #; opening this check

Payment

D2: 00: Non-payment, 01: Payment

Item

Item (PLU / Subdepartment / Department)

0	1	2	3	5	7	9	11	13	18	23	28	30	32	35	50
Mc ID	03	Type #2	File-# *1	Rec-# *1	Tax status *3	Item status *4	Void reason	Quantity	Amount	Unit price	Pulldown group rec-#	Not Used	Random code	Not Used	

Function

Cash, Charge, Check, Credit

0	1	2	3	5	7	9	14	19	24	29	30	50
Mc ID	03	Type	File-# *1	Rec-# *1	CE key Rec-#	Tendering amount in foreign currency	Tendering amount in local currency	Total Amount	Change Amount	Totaling Type	Not Used	

Food stamp tender, EBT tender

0	1	2	3	5	7	12	17	22	27	28	50
Mc ID	03	Type	File-# *1	Rec-# *1	Tendering amount	Food stamp subtotal amount	Food stamp change amount (only for FS/TD)	Cash change Amount	Totaling Type	Not Used	

Totaling Type

0: Total operation, 1: Change operation, 2: Partial tender operation

New balance

0	1	2	3	5	7	12	17	50
Mc ID	03	Type #2	File-# *1	Rec-# *1	Gross quantity	Gross amount	Not Used	

*1 ~ *4: Refer to the last page of this section.

Application System

+ / - / Coupon

0	1	2	3	5	7	9	11	16	21	26	50
Mc ID	03	Type *2	File-# *1	Rec-# *1	Tax status *3	Item status *4	No.	Amount	Price	Not Used	

%+ / %-

0	1	2	3	5	7	9	11	16	21	26	31	50
Mc ID	03	Type *2	File-# *1	Rec-# *1	Tax status *3	Item status *4	No.	Amount	Price	Rate	Not Used	

%+ / %- after selective item subtotal

0	1	2	3	5	7	9	16	21	26	31	50
Mc ID	03	Type *2	File-# *1	Rec-# *1	Selective item status-#	Not Used	Amount	Rate	Discount amount	Not Used	

Selective item status-#
 1: Selective item 1
 2: Selective item 2

print (# or #/NS)

0	1	2	3	5	7	12	14	50
Mc ID	03	Type *2	File-# *1	Rec-# *1	Number	Figures	Not used	

Tax exempt

0	1	2	3	5	7	9	14	19	24	29	34	39	44	50
Mc ID	03	Type *2	File-# *1	Rec-# *1	Tax status *3	Taxable amount 1	Taxable amount 2	Taxable amount 3	Taxable amount 4	Taxable amount 5	Taxable amount 6	Taxable amount 7	Not Used	

Field name	Taxable amount 1	Taxable amount 2	Taxable amount 3	Taxable amount 4	Taxable amount 5	Taxable amount 6	Taxable amount 7
VAT	TA1	TA2	TA3	TA4	TA5	TA6	TA7
U.S.	TA1	TA2	TA3	--	--	--	--
Canada	TA1	TA2	TA1 & 2	TA3	TA1 & 3	TA4	TA1 & 4
Singapore	TA1	TA1 & 3	TA2	TA 2 & 3	TA3	--	--

ST / MDST

0	1	2	3	5	7	12	17	22	24	50
Mc ID	03	Type *2	File-# *1	Rec-# *1	Subtotal amount	Printed subtotal amount	Subtotal amount after CE	CE key rec-#	Not Used	

*1 ~ *4: Refer to the last page of this section.

Media change / Tray total

0	1	2	3	5	7					50
Mc ID	03	Type *2	File-# *1	Rec-# *1	Not Used					

Store

0	1	2	3	5	7	12	18	24	50	
Mc ID	03	Type *2	File-# *1	Rec-# *1	Subtotal amount	Not Used	Check-#	Not Used		

Eat-in / Takeout

0	1	2	3	5	7	12	50			
MCID	03	Type *2	File-# *1	Rec-# *1	Amount	Not Used				

Cancel

0	1	2	3	5	7	12	50			
MCID	03	Type *2	File-# *1	Rec-# *1	Amount	Not Used				

Loyalty discount

0	1	2	3	7	9	16	21	26	31	50
Mc ID	03	Type *2	Not Used	Selective item status-#	Not Used	Amount	Rate	Discount amount	Not Used	

Selective item status-#

- 0: ST %-
- 1: Selective item 1 %-
- 2: Selective item 2 %-

*1 File-#, Rec-#:

These are stored in Hexa-decimal. If the data is "ABCD", it means "CDAB".

*2 Type:

It means record type, refer to 2-12-5 IDC data type section of this manual.

*3 Tax status:

- Single tax/VAT
 - b1: T/S1, b2: T/S2, b3: T/S3, b4: T/S4, b5: T/S5, b6: T/S6, b7: T/S7, b8: T/S8, b9: T/S9, b10: T/S10
- U.S. or Singapore
 - b1: T/S1, b2: T/S2, b3: T/S3, b4: F/S
- Canada
 - b1: T/S1, b2: T/S2, b3: T/S3, b4: T/S4, b9: Donuts tax

*4 Item status:

- b6-: not used, b5: 2nd@registration, b4: house Bon registration,
- b3: <COUPON2> registration, b2: <REFUND> registration, b1: <VOID> registration

Application System

2-12-5. IDC data type

Type of data	Type	Capture item
DTLTYPE_SDEPT	0A	Main item : Subdepartment
DTLTYPE_DEPT	0F	Main item : Department
DTLTYPE_PLU	14	Main item : PLU
DTLTYPE_SET_FIX	19	Dependent item : Set-menu/child (fixed)
DTLTYPE_SET_SEL	1E	Dependent item : Set-menu/child (option)
DTLTYPE_COND	23	Dependent item : Condiment *
DTLTYPE_PREP	28	Dependent item : Preparation
DTLTYPE_ITEM_PLUS	3C	Dependent item (discount) : item +
DTLTYPE_ITEM_MINUS	3D	Dependent item (discount) : item -
DTLTYPE_ITEM_CPN	3E	Dependent item (discount) : item CPN
DTLTYPE_ITEM_P_PLUS	3F	Dependent item (discount) : item %+
DTLTYPE_ITEM_P_MINUS	40	Dependent item (discount) : item %-
DTLTYPE_CASH	47	Finalize : Cash
DTLTYPE_CHARGE	48	Finalize : Charge
DTLTYPE_CHECK	49	Finalize : Check
DTLTYPE_CREDIT	4A	Finalize : Credit
DTLTYPE_NBCHKTRC	50	NB (check tracking) operation
DTLTYPE_NBTBLTR	52	NB (table transferring) operation
DTLTYPE_CANCEL	55	Cancel
DTLTYPE_TBLTR	56	Table transfer
DTLTYPE_NBFEE	57	NB fee
DTLTYPE_STORE	58	Store
DTLTYPE_ST_PLUS	64	ST +
DTLTYPE_ST_MINUS	65	ST -
DTLTYPE_ST_CPN	66	ST CPN
DTLTYPE_ST_P_PLUS	67	ST %+
DTLTYPE_ST_P_MINUS	68	ST %-
DTLTYPE_SIST_PERCENT_PLUS	69	SIST +
DTLTYPE_SIST_PERCENT_MINUS	6A	SIST -
DTLTYPE_ST	6F	ST
DTLTYPE_MDST	70	MDST
DTLTYPE_PRT_CHAR	71	PRINT CHAR
DTLTYPE_SHARP	73	# Print
DTLTYPE_TIP	74	Tip
DTLTYPE_DEPO	75	Deposit
DTLTYPE_TXEX	76	Tax exempt
DTLTYPE_EATIN	77	Eat-in
DTLTYPE_TAKEOUT	78	Takeout
DTLTYPE_TRAYTTL	79	Tray total
DTLTYPE_RC	96	RC
DTLTYPE_PD	97	PD
DTLTYPE_MEDIA_CHG	98	Media change
DTLTYPE_GET_MONEY	99	Media change (get)
DTLTYPE_PUT_MONEY	9A	Media change (put)
DTLTYPE_LOAN	9B	Loan
DTLTYPE_PICKUP	9C	Pick up
DTLTYPE_FIN_LOANPICKUP	9D	Finalize loan/pick up
DTLTYPE_AMOUNT_EXCHANGE	9E	Currency exchange
DTLTYPE_CASH_IN_CHECK	9F	Cashing a check
DTLTYPE_CUST_DISCOUNT	AA	Loyalty discount

* Includes the item registered as a child PLU

2-12-6. Transferring IDC

It is possible to do collection of IDC files through inline system. Refer to the terminal structure as below.

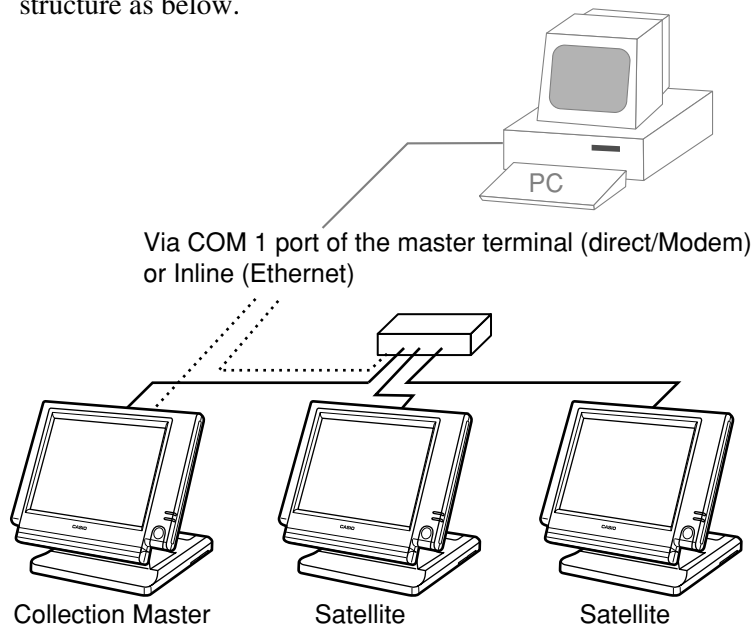

Flow of the transferring IDC

1. PC sends Z-lock command by using job command to collection master. PC enables to check the Z-lock confirmation.
2. PC sends the consolidation command by using Job command to collect IDC files from all satellite terminals.
3. Collection master receives the IDC data from each satellite in order. PC enables to check whether the collection master has finished the job.
4. PC sends the Z-command or X-command to the collection master.
5. PC receives the collection data from consolidation file. If the Z-command has issued at step 4, consolidation file in the collection master are all reset.

Data transferring flow

IDC data in each terminal totalizer is appended to the consolidation file individually.

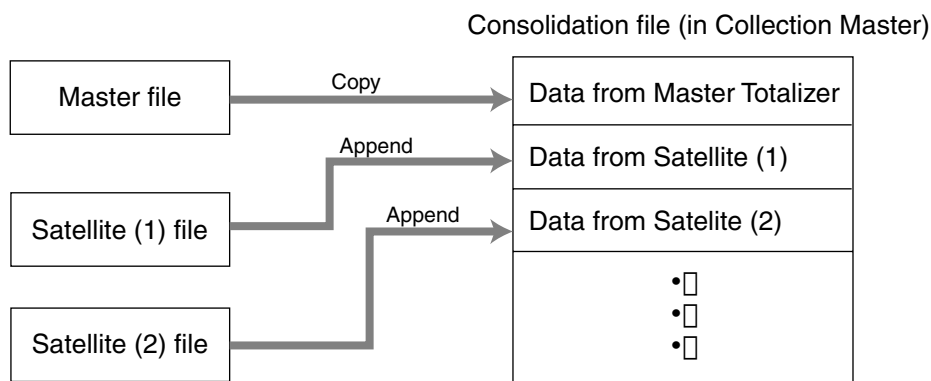

Notes:

- Just after IDC starts, the total file is cleared to receive new data.
- Just after the receiving is over, the data is remained in the consolidation file. To clear this data, send the Z-command or the file-clear command to the collection master from the PC. (Set “No”, to “Reset consolidation total after inline consolidation” in the programming the communication in the machine feature programming.
- In case of collection Z, all of the IDC files in the satellite terminals are cleared.

2-13. Electronic journal

There are two types of electronic journal. One is “normal” electronic journal, the other is “intelligent” electronic journal. The “normal” electronic journal stores all operations such as registration, report issuing and programming, but the “intelligent” electronic journal stores only registration. And the “intelligent” electronic journal stores one receipt when the transaction is finalized (not stored at new balance). You can select the “normal” or the “intelligent” electronic journal by allocating the “normal” electronic journal file (file-048 and -648) or the “intelligent” electronic journal file (file-050 and -650)

Electronic journal is stored in the terminal memory, so it is possible to print journal (electronic journal report) by date or by consecutive number.

And since the journal data is stored in the memory, you can collect journal data from all terminals in the system. Also, you can issue receipt and guest receipt from electronic journal.

2-13-1. Storing electronic journal

The electronic journal starts automatically and it ends if the journal memory becomes full. When the memory becomes full, the terminal alerts end error which you can select to alert or not to alert by programming. Refer to the page 38 of the programming manual.

Notes:

Even if the electronic journal memory is full, registrations are not disturbed.

2-13-2. Issuing electronic journal report

You can issue both type of the electronic journal read or reset report by date or by consecutive number.

Refer to the page 145 of this manual.

2-13-3. Displaying electronic journal and producing guest receipts after sales

Pressing the <EJ DISP> key shows the most recent transactions. You can go to older transactions by pressing the <PAGE UP> key while newer transactions by the <PAGE DOWN> key. And also you can move lines in a transaction by the <↑> or <↓> key.

During displaying an transaction, you can issue the post receipt of this transaction by pressing the <RECEIPT> key. If the guest receipt in the original transaction was issued you can get the copy of the guest receipt by pressing the <RECEIPT> key.

2-13-4. Transferring electronic journal memory

It is possible to do collection of electronic journal files through inline system. Refer to the terminal structure illustrated below.

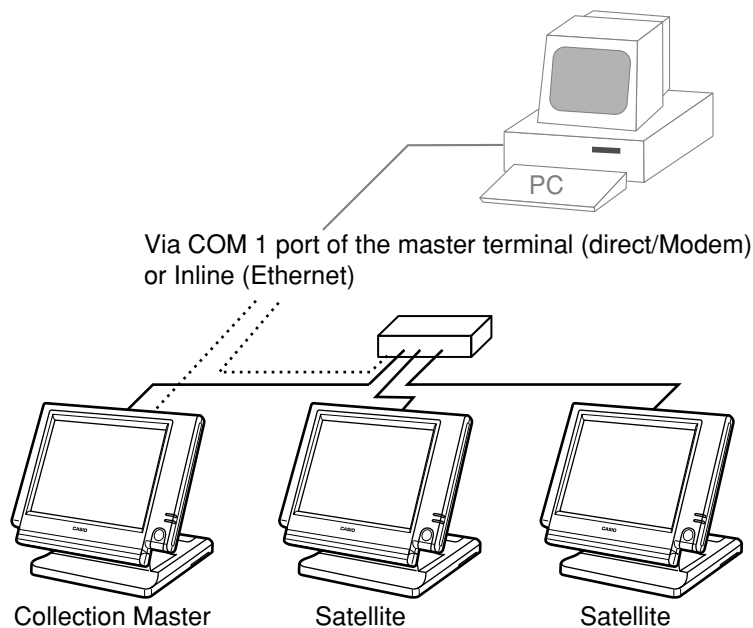

Flow of the transferring electronic journal

1. PC sends the collection command by using Job command to collect electronic journal file from a satellite terminal.
2. Collection master receives the electronic journal data from a satellite. PC enables to check whether the collection master has finished the job.
3. PC sends the data send command to the collection master for the collected electronic journal data.
4. PC receives the collection data from the master. If the Z-command has issued at step 3, electronic journal file in the satellite is all reset.
5. Repeat step 1 ~ 4 for all satellites.

Data transferring flow

Electronic journal data in each terminal is appended to the consolidation file individually.

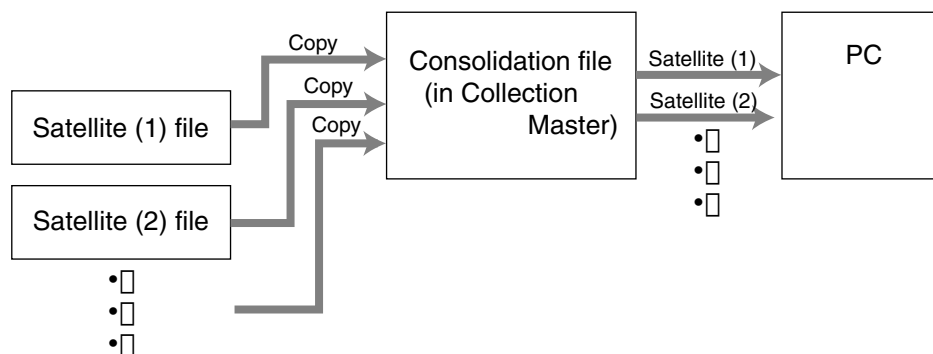

File 048 and 648 for "normal" electronic journal.
File 050 and 650 for "intelligent" electronic journal.

3. Manager operation	R-82
3-1. Machine initialization	R-82
3-1-1. INIT	R-82
3-1-2. Flag clear	R-82
3-1-3. INIT 2	R-83
3-1-4. INIT code	R-83
3-2. IPL (Initial Program Loading)	R-83
3-2-1. IPL	R-83
3-2-2. System configuration before IPL operation	R-84
3-2-3. IPL operation	R-85
3-3. Manager function	R-86
3-3-1. System connection check	R-86
3-3-2. Remote on	R-87
3-3-3. Remote off	R-87
3-3-4. Busy reset	R-88
3-3-5. Stock maintenance	R-89
3-3-6. Drawer for clerk	R-90
3-3-7. CHK# (Clerk interrupt)	R-90
3-3-8. Order ID change	R-91
3-3-9. Error log print	R-92
3-3-10. System re-configuration	R-93
3-3-11. Item Data Capture	R-94
3-3-12. Euro change over	R-95
3-3-13. Clerk window	R-96
3-3-14. Customer	R-97
3-3-15. Customer busy reset	R-98
3-3-16. Sound	R-98
3-3-17. Clerk number	R-99
3-3-18. Operation monitor	R-99
3-3-19. FTP client	R-99-1
3-4. System command execution	R-100
3-4-1. X/Z reporting	R-100
3-4-2. X/Z collection / consolidation	R-101
3-4-3. Remote power control	R-102
3-5. Data communication system	R-103
3-5-1. Inline / online connectors	R-103
3-5-2. Hardware interface	R-104
3-5-3. Inline / online functions	R-106
3-6. Collection / Consolidation system	R-107
3-6-1. X/Z collection	R-109
3-6-2. X/Z consolidation	R-111
3-6-3. X/Z collection / consolidation	R-113
3-7. Auto-programming function	R-116
3-7-1. Auto-programming functions	R-116
3-7-2. Auto-program operation and CF card utilities	R-117

Manager Operation

3. Manager operation

This section describes manager operations (such as machine initialization, IPL, manager functions etc.) of QT-6100.

3-1. Machine initialization

There are three different types of initialization such as INIT, FC, and INIT2.

INIT; Machine initialization, all program and total data are reset.

FC; Flag clear, all program and total data are remained, only the current transaction data are reset.

INIT2; Machine initialization 2, all program data are remained, only total data are reset.

The procedures of machine initialization are described in the chapter 1 of the programming manual. The required passwords are listed below.

Operation	Password	Digit meaning
Init	00020000	for the U.S.
	00010000	for other area (default descriptors are initialized in English)
	00040000	for other area (default descriptors are initialized in German)
	00050000	for other area (default descriptors are initialized in French)
	00060000	for other area (default descriptors are initialized in Spanish)
	00080000	Arabic (default descriptors are initialized in English)
Flag clear	No need	
Init2	8888888888	

* See the "INIT code" section to notice the detail information of the last four digits.

3-1-1. INIT

Initialization process is as follows:

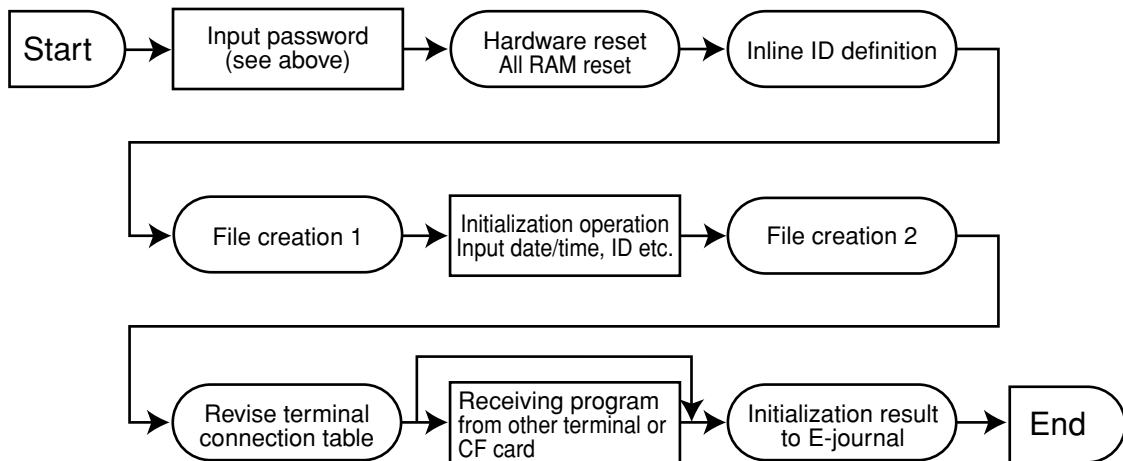

3-1-2. Flag clear

Flag clear process is as follows:

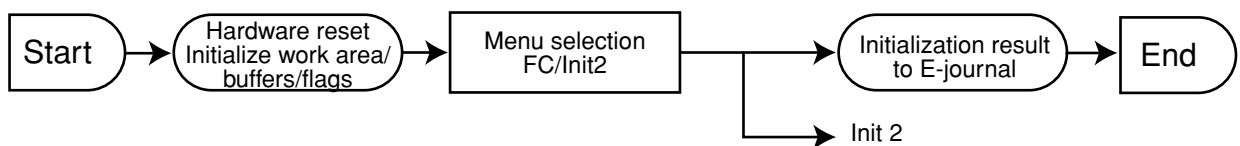

3-1-3. INIT 2

Initialization 2 process is as follows:



3-1-4. INIT code

Description	Choice	Program code
Area code: U.S. : 2 Other area (default descriptor in English) : 1 (default descriptor in German) : 4 (default descriptor in French) : 5 (default descriptor in Spanish) : 6 (using Arabic character table) : 8	Significant number	<input type="checkbox"/> D ₅
always 0	Significant number	<input checked="" type="checkbox"/> D ₄
COM3 Not use remote display : 0 Use remote display : 3	Significant number	<input type="checkbox"/> D ₃
always 0	Significant number	<input checked="" type="checkbox"/> D ₂
always 0	Significant number	<input checked="" type="checkbox"/> D ₁

3-2. IPL (Initial Program Loading)

IPL should be made before initializing when the application software has been modified.

3-2-1. IPL

Initial program loading process is as follows: IPL code = 44449999

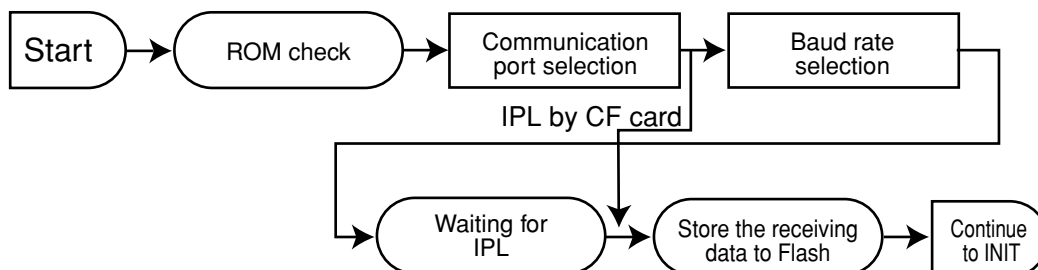

Manager Operation

3-2-2. System configuration before IPL operation

Connect source terminal (cash register terminal/PC) and target terminals or insert the IPL CF card to the terminal.

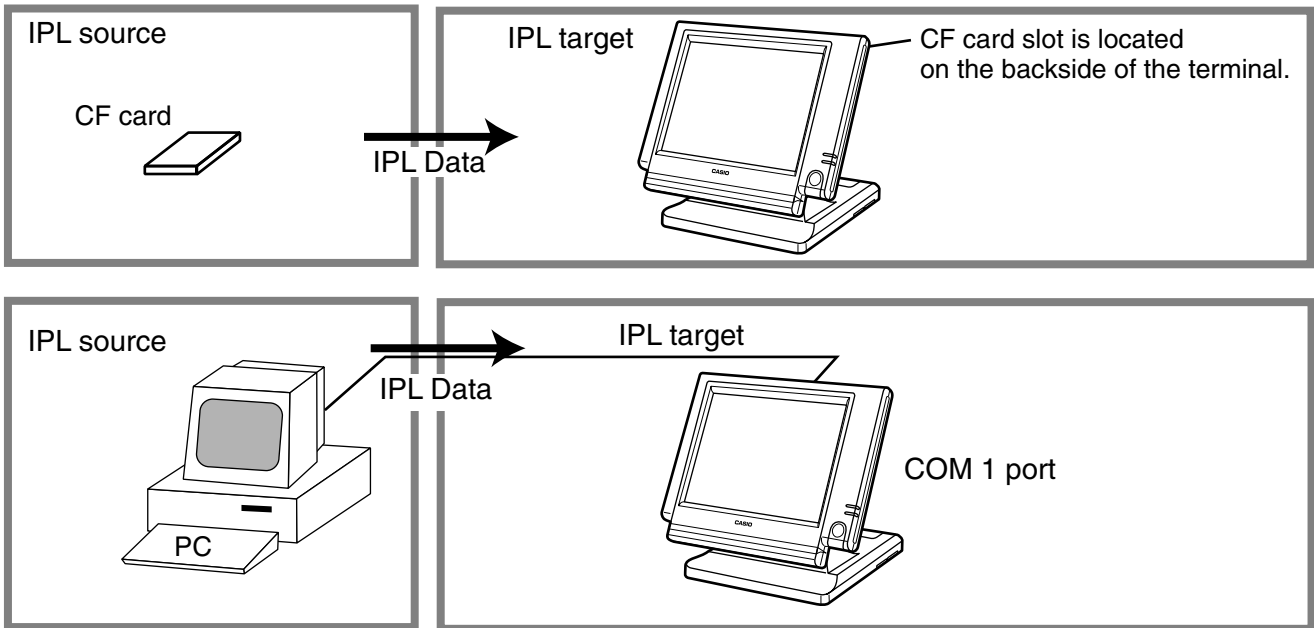

3-2-3. IPL operation

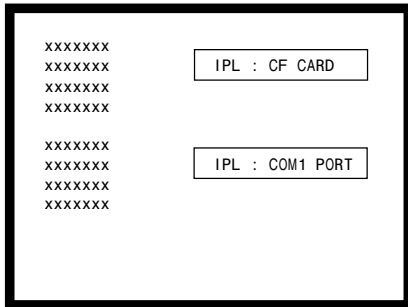

If you select “CF card”, insert the CF card into the slot before this step.

1. Select the appropriate method to loading IPL data.

(using COM PORT)

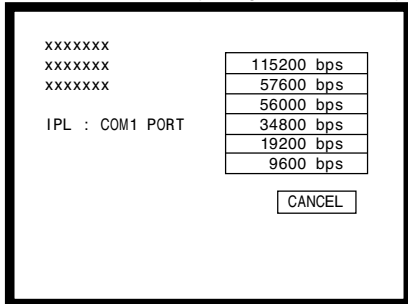

2. If you choose COM port or IN LINE port, select baud rate of the IPL source device.

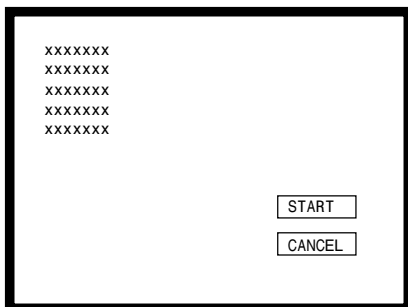

3. Press the <START> key to proceed, in case of downloading via inline, automatic ID definition is made by this timing. So press the <YES> key terminal by terminal.

4. After finishing IPL, machine initialization is necessary.

Manager Operation

3-3. Manager function

Using the manager function makes it possible to control the terminal conditions. The contents of the manager function are as follows:

1. System connection check
2. Remote on
3. Remote off
4. Busy reset
5. Stock maintenance
6. Drawer for clerk
7. CHK# (Clerk interrupt)
8. Order ID change
9. Error log print
10. System re-configuration
11. Item Data Capture
12. EURO Change over.
13. Clerk window
14. Customer
15. Customer Busy Reset
16. Recording
17. Clerk number
18. Operation monitor
19. FTP client

3-3-1. System connection check

This command shows the connection status of terminals, and printers.

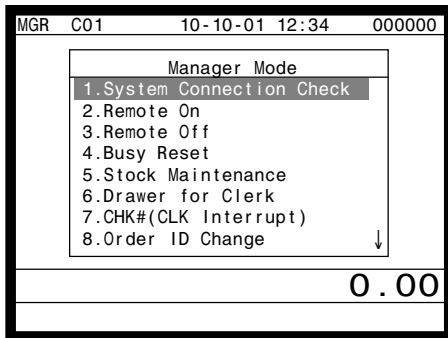

1. Sign on a clerk (if necessary).
2. Press <Manager> to assign manager mode.

3. Select "1. System Connection Check" and press the <YES> key.

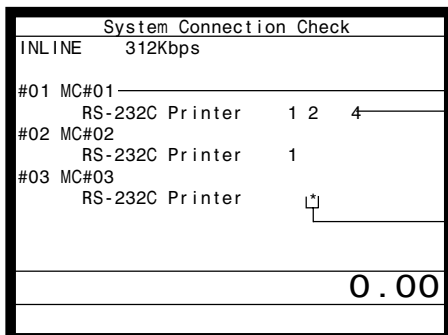

Physical ID, Logical ID
RS-232C printer recognition (1: printer (1), 2: printer (2), 4: slip printer)

Un recognized RS-232C printer

4. After checking the system connection, press the <ESC> key to return the previous menu.

Note:

If there is unrecognized terminal there it shows "*" as below.
example) #04 *****

3-3-2. Remote on

This command is used to power on the terminals connected with the same inline.

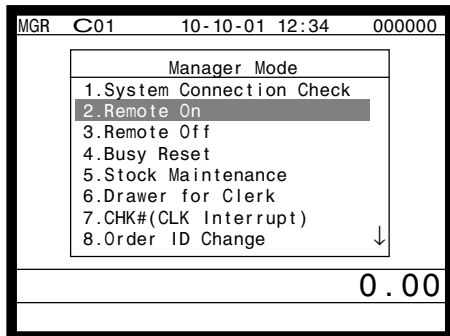

1. Sign on a clerk (if necessary).
2. Press <Manager> to assign manager mode.

3. Select "2. Remote On" and press the <YES> key.

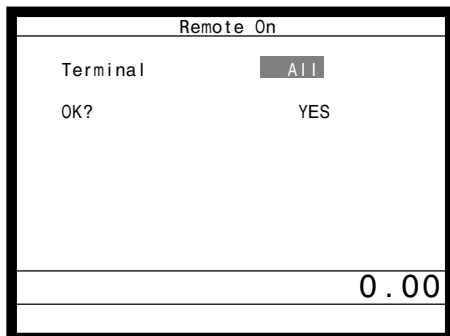

4. Select all terminals or individual terminal, select "YES" to execute this command.

3-3-3. Remote off

This command is used to power off the terminals connected with the same inline.

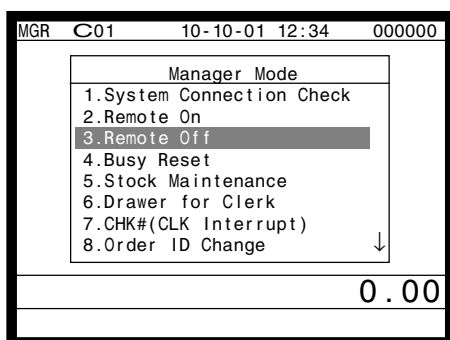

1. Sign on a clerk (if necessary).
2. Press <Manager> to assign manager mode.

3. Select "3. Remote Off" and press the <YES> key.

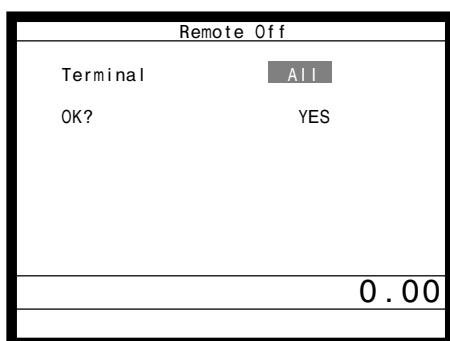

4. Select all terminals or individual terminal, select "YES" to execute this command.

Manager Operation

3-3-4. Busy reset

This command is used to release the busy flag of the check used by other dead terminal. Executing this command always releases this flag, so please be careful to perform this operation.

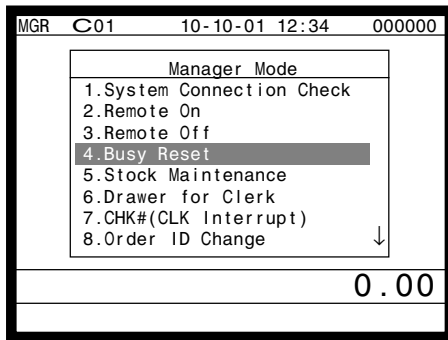

MGR C01 10-10-01 12:34 000000

Manager Mode	
1.	System Connection Check
2.	Remote On
3.	Remote Off
4.	Busy Reset
5.	Stock Maintenance
6.	Drawer for Clerk
7.	CHK#(CLK Interrupt)
8.	Order ID Change

0.00

1. Sign on a clerk (if necessary).
2. Press <Manager> to assign manager mode.

3. Select "4. Busy Reset" and press the <YES> key.

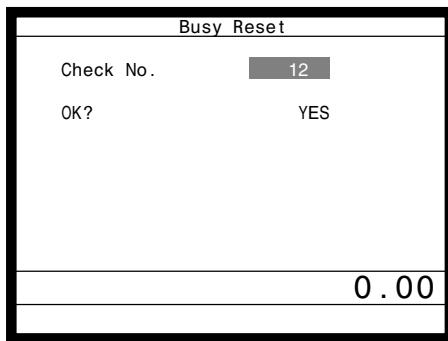

Busy Reset

Check No. 12

OK? YES

0.00

4. Enter the appropriate check number, and then select "YES" to execute this command.

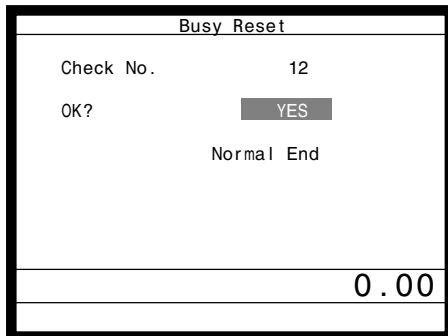

Busy Reset

Check No. 12

OK? YES

Normal End

0.00

3-3-5. Stock maintenance

This command is used to update PLU stock quantities brought by purchasing or inventory processing.

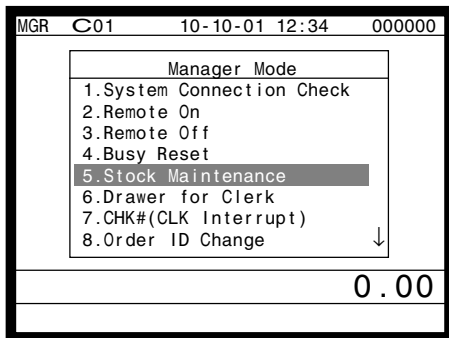

1. Sign on a clerk (if necessary).
2. Press <Manager> to assign manager mode.

3. Select "5. Stock Maintenance" and press the <YES> key.

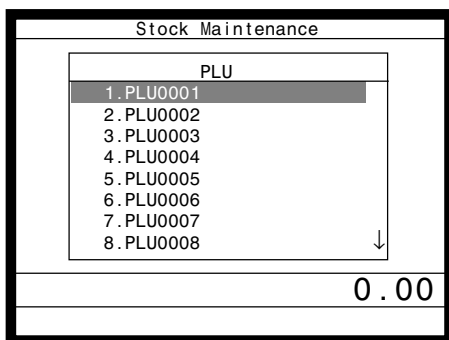

4. Select the appropriate PLU and press the <YES> key.

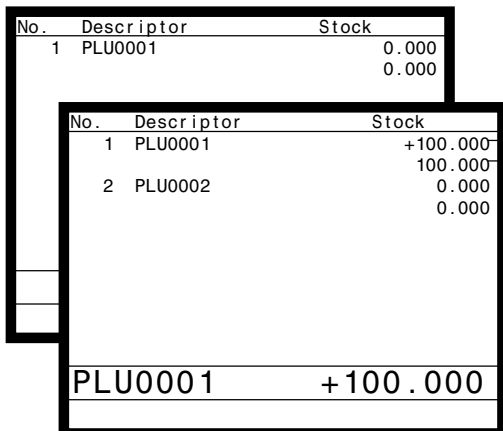

Entered stock quantity

Total stock quantity

5. Enter adjustment (adding) stock value and press the <YES> key. If you want to decrease stock value, press the <RF> key before entering the stock value.

The next PLU appears on the screen.

6. Press the <ESC> key to terminate this sequence.

7. Press the <ESC> key to issue receipt.

RECEIPT

Stock Maintenance		
No.	Descriptor	Stock
1	PLU0001	+100.000
		100.000
2	PLU0002	0.000
		0.000

Manager Operation

3-3-6. Drawer for clerk

This command is used to designate the drawer 1 ~ 2.

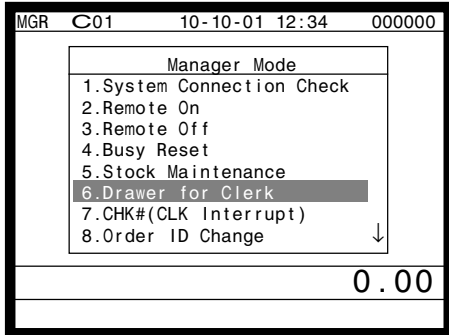

1. Sign on a clerk (if necessary).
2. Press <Manager> to assign manager mode.

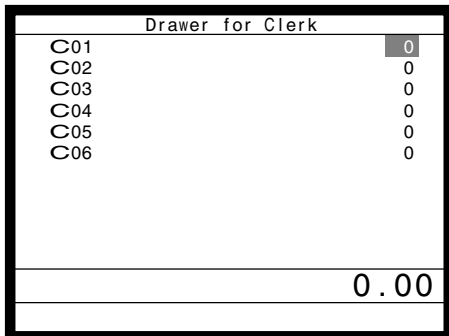

3. Select “6. Drawer for Clerk” and press the <YES> key.
The display shows “Clerk name/Drawer No.” list.
4. Select the drawer No. field of the appropriate clerk, enter the drawer number (1 or 2, “0” means drawer 1), and press the <YES> key.
5. Press the <ESC> key to return to the previous menu.

3-3-7. CHK# (Clerk interrupt)

This command is used to designate the check number for clerk interrupt to each clerk.

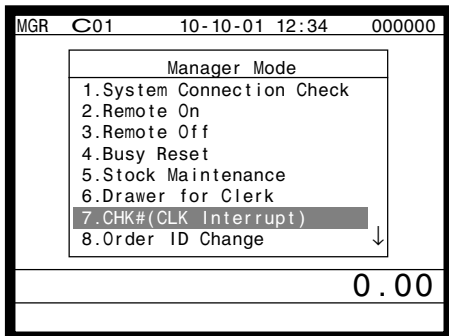

1. Sign on a clerk (if necessary).
2. Press <Manager> to assign manager mode.

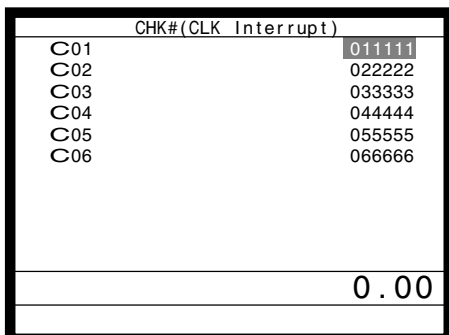

3. Select “7. CHK#(CLK Interrupt)” and press the <YES> key.
The display shows “Clerk name / Check No.” list.
4. Select the check No. field of the appropriate clerk, enter the check number (within 6-digits), and press the <YES> key.
5. Press the <ESC> key to return the previous menu.

3-3-8. Order ID change

This command is used to change the target printer of order temporarily.

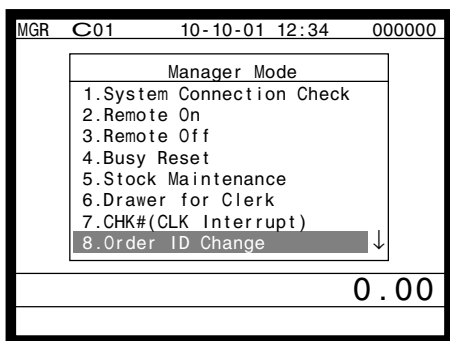

1. Sign on a clerk (if necessary).
2. Press <Manager> to assign manager mode.

3. Select “8. Order ID Change” and press the <YES> key.

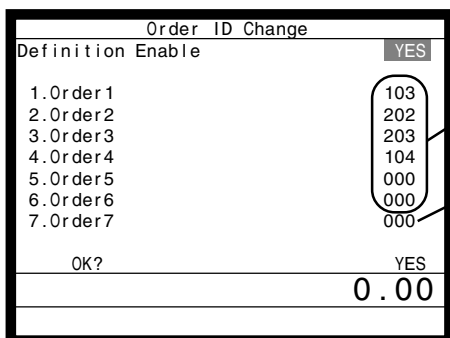

$D_3D_2D_1$

“Order 7” cannot be used.

4. Select “YES” of the Definition Enable field, and enter an appropriate ID number of each order printer and press the <YES> key. Select “YES” of the last line to execute this command.

Note: $D_3 D_2 D_1$

In case of $D_3 = 1$, D_2 & D_1 defines the terminal physical ID that connect to printer-1.
In case of $D_3 = 2$, D_2 & D_1 defines the terminal physical ID that connect to printer-2.
In case of $D_3 = 3$, D_2 & D_1 defines the terminal physical ID that connect to printer-3.

Manager Operation

3-3-9. Error log print

This command is used to display / print out the error log file.

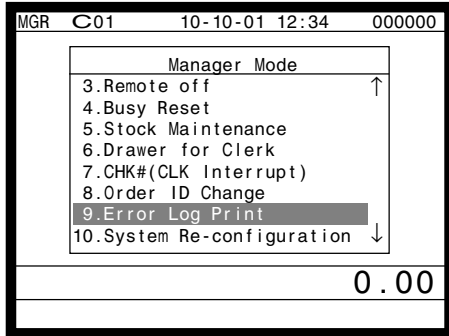

1. Sign on a clerk (if necessary).
2. Press <Manager> to assign manager mode.

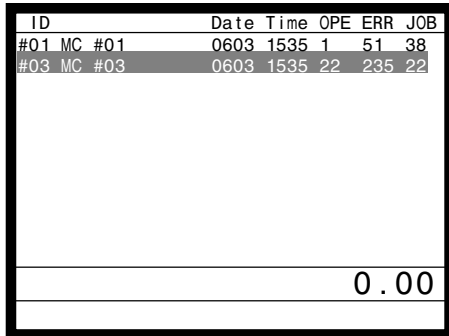

3. Select “9. Error Log Print” and press the <YES> key.

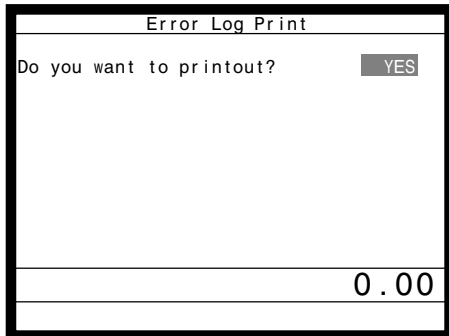

4. The display shows current error log.
Then press the <ESC> key.

5. Press the <YES> key if you want to print error log.
If you do not want to print error log, press the <ESC> key.

RECEIPT

Error Log Print					
ID	Date	Time	OPE	ERR	JOB
#01 MC #01	0603	1535	1	51	38
#03 MC #03	0603	1535	22	235	22
#00	0000	0000	0	0	0

3-3-10. System re-configuration

This command is one procedure of down recovery. It backs the contents of the system connection table to the original value.

It should be executed under these conditions:

- 1) After issuing “Open check report”.
- 2) All terminals are connected and work without any trouble. (Check by system connection check)
- 3) No terminal is in registration, collection, consolidation, sending/receiving programs.
- 4) Activate “System re-configuration” command at the terminal on which the “Cut-off” icon is lit.

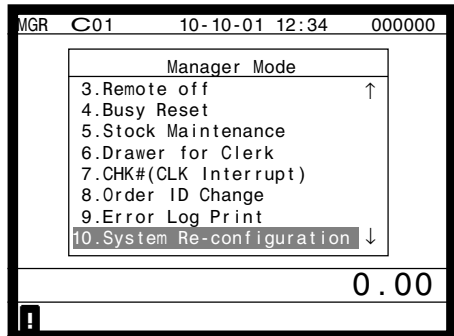

Cut-off Master or Backup master icon

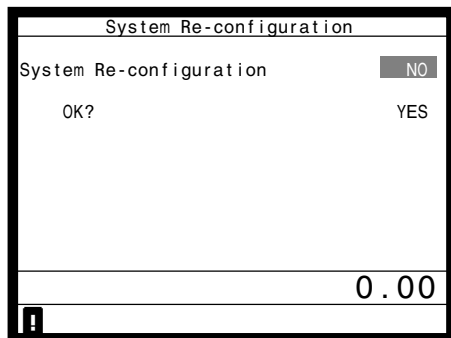

1. Sign on a clerk (if necessary).
2. Press <Manager> to assign manager mode.
3. Select “10. System Re-configuration” and press the <YES> key.

4. Choose the option “YES (Perform system re-configuration) / NO (Abort this procedure)” and press the <YES> key.

Manager Operation

3-3-11. Item Data Capture

You can change the IDC status (capture transaction data or not) by the operation described below.

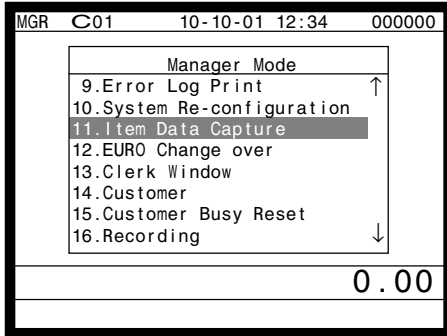

1. Sign on a clerk (if necessary).
2. Press <Manager> to assign manager mode.

3. Select "11. Item Data Capture" and press the <YES> key.

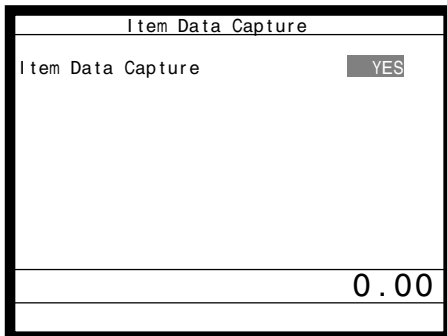

4. Choose the option "YES (capture item data)/NO (not capture item data)" and press the <ESC> key.

3-3-12. Euro change over

After this operation, the following subjects are made:

- (1) The Euro is defined as main currency and the local is defined as sub currency.
- (2) All totals and counts are reset.
- (3) Unit prices (department, subdepartment, PLU, 2nd @, shift PLU) are converted in Euro.

Before “change over operation”,

- (1) Issue all reset report including open check report, if necessary.
- (2) Sign off all cashier/clerk and stop all operations of all terminals of the system.

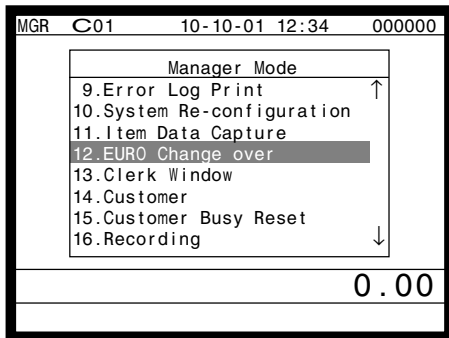

1. Sign on a clerk (if necessary).
2. Press <Manager> to assign manager mode.

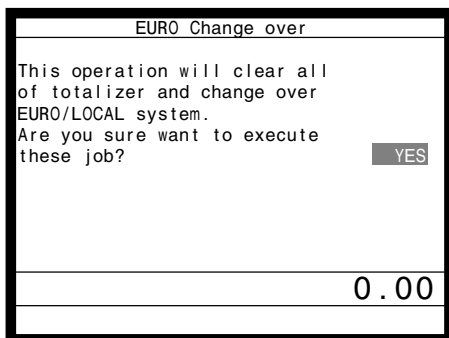

3. Select “12. EURO Change over” and press the <YES> key.

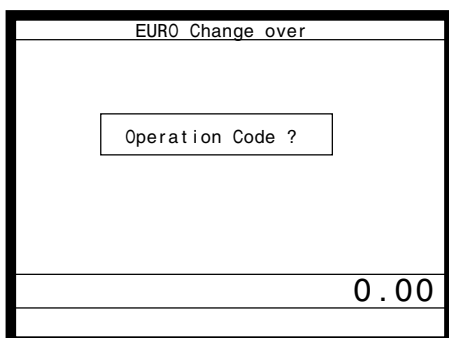

4. If you want to proceed this step, press the <YES> key. To abort this step, press the <NO> or <ESC> key.

5. If you want to proceed this step, enter “8888888888” and press the <YES> key. (It takes a few minutes.) To abort this step, press the <NO> or <ESC> key.

RECEIPT

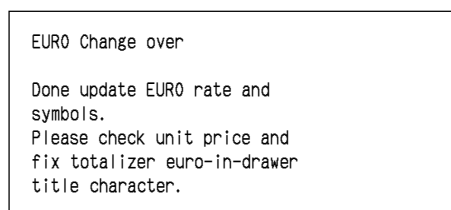

Perform the same operation of all the terminals of the system.

Manager Operation

3-3-13. Clerk window

You can program clerk window contents in the MGR mode.

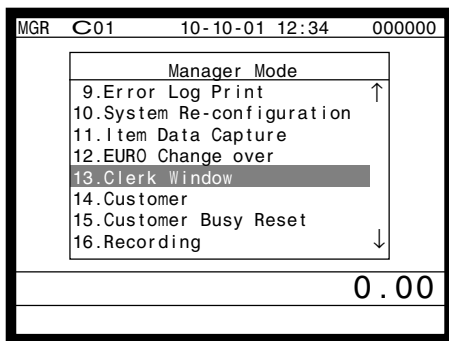

1. Sign on a clerk (if necessary).
2. Press <Manager> to assign manager mode.

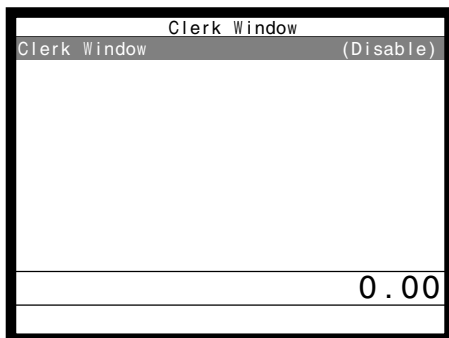

3. Select "13.Clerk Window" and press the <YES> key.

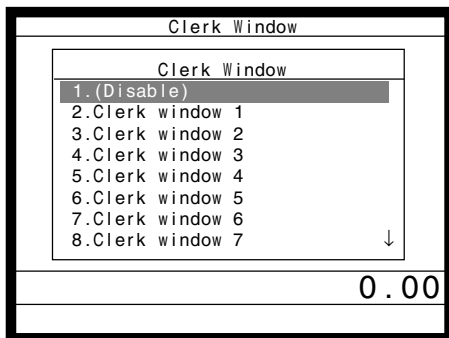

4. Press the <YES> key to continue.

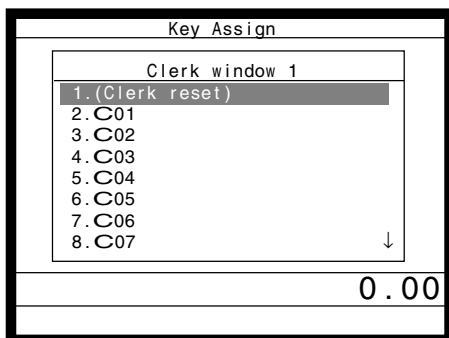

5. Select the clerk window. If you don't use clerk window, select "1.(Disable)".

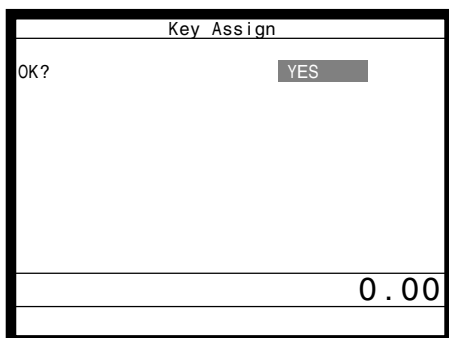

6. Select the clerk to allocate the clerk window. After this operation, select the appropriate key in the clerk window.

7. Press the <YES> key to set this program.

3-3-14. Customer

You can program (add / modify / delete) the customer (name, address etc.) in the MGR mode.

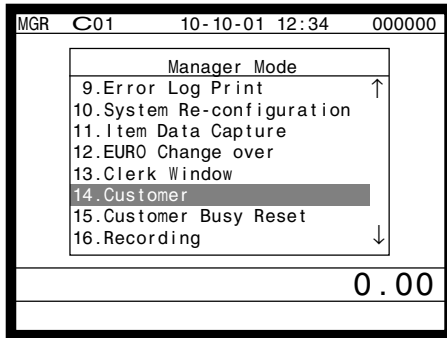

1. Sign on a clerk (if necessary).
2. Press <Manager> to assign manager mode.

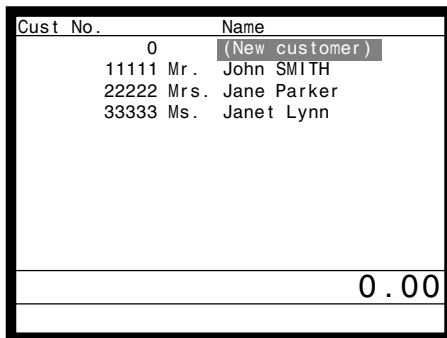

3. Select "14.Customer" and press the <YES> key.
4. **Add customer:** Select (New customer) and press the <YES>. Then input the customer No. and press the <YES> in the next screen.
Modify customer: Select the appropriate customer and press the <YES>.
Delete customer: Select the appropriate customer and press the <NO>.
- If you swipe a card at this timing, "add customer (new card)" or "modify customer (already programmed card)" is performed.

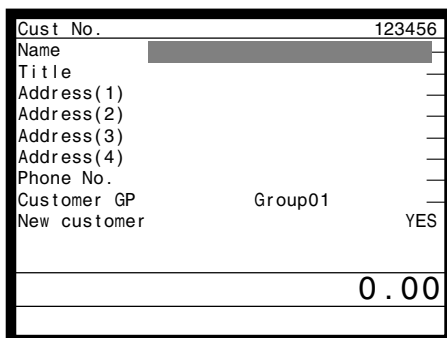

- Customer name (up to 24 characters)
- Customer title (select from sub menu)
- Customer address 1 (up to 24 characters)
- Customer address 2 (up to 24 characters)
- Customer address 3 (up to 24 characters)
- Customer address 4 (up to 24 characters)
- Customer phone No. (up to 12 digits)
- Customer group (select from sub menu)

5. Press the <ESC> to set and continue to program new customer.

Manager Operation

3-3-15. Customer busy reset

This command is used to release the busy flag of the customer used by other dead terminal. Executing this command always releases this flag, so please be careful to perform this operation.

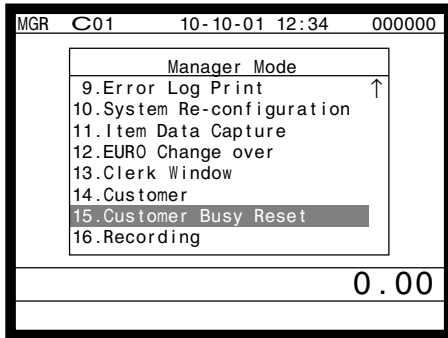

1. Sign on a clerk (if necessary).
2. Press <Manager> to assign manager mode.
3. Select "15. Customer Busy Reset" and press the <YES> key.
4. Enter the appropriate customer number, and then select "YES" to execute this command.

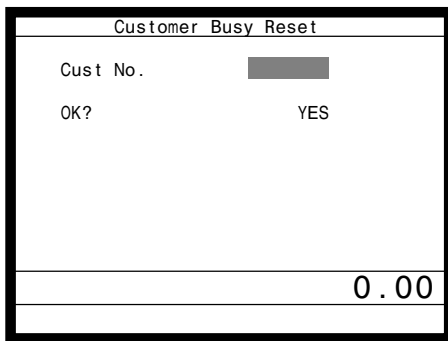

RECEIPT

Busy Reset	
CUST No. 123456	
Dr.	
Big Scientist	
BALANCE	\$45.90
DISCOUNT	\$3.23

3-3-16. Sound

QT-6100 does not have Microphone and speaker. This feature does not work.

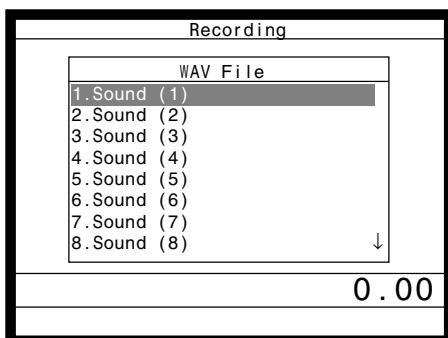
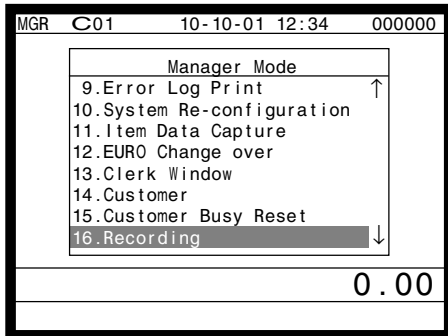

3-3-17. Clerk number

You can program clerk number directly to the <CLK#> key in the MGR mode.

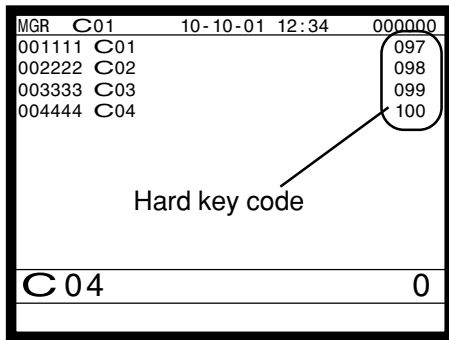

1. Sign on a clerk (if necessary).
2. Press <Manager> to assign manager mode.
3. Enter "00" and the clerk number you want to set and press the appropriate <CLK#> key.
(Entering "000000" clears the clerk number program.)

4. To terminate this step, press the <ST> key.

3-3-18. Operation monitor

You can monitor a clerk's operation by monitoring display and receipt (in case of connecting printer).

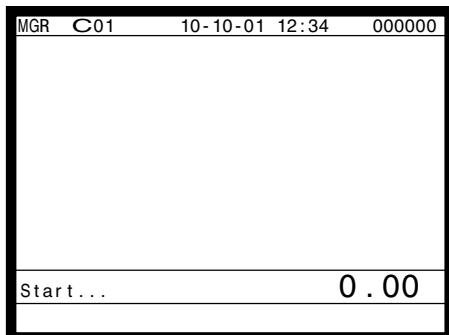

1. Sign on a clerk (if necessary).
2. Press <Manager> to assign manager mode.
3. Enter "99990000nn (nn: terminal ID No. to monitor)" and press the <ST> to start operation monitor.

Note: Do not designate the monitored or monitoring terminal.

The display shows the screen of the monitored terminal.
The receipt shows the printout of the monitored terminal.

4. Press <ESC> twice break the monitoring.

Manager Operation

3-3-19. FTP client

You can execute FTP client processing by the operation below.

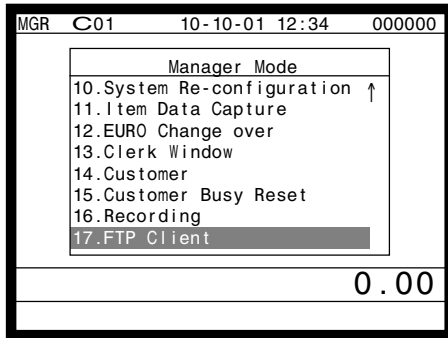

1. Sign on a clerk (if necessary).
2. Press <Manager> to assign manager mode.

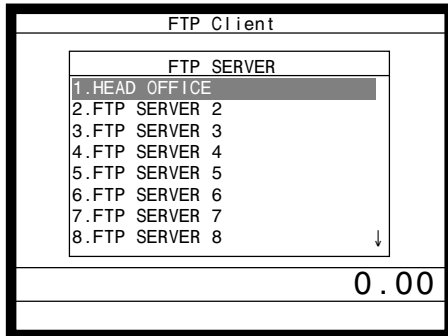

3. Select "17. FTP Client" and press the <YES> key.

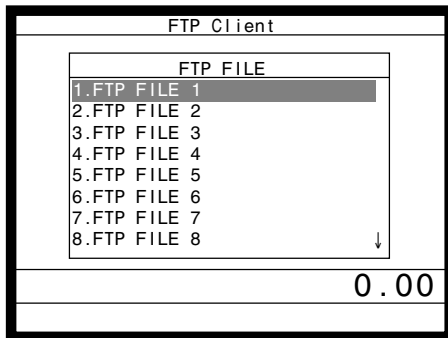

4. Select the appropriate FTP server in the list, and press <YES>.

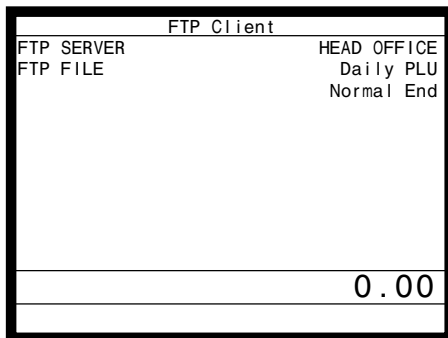

5. Select the appropriate FTP file in the list, and press <YES>. The process programmed in the file 912 / 913 is executed.

6. Check the execution result and press <ESC> to exit.

Manager Operation

3-4. System command execution

System command functions are provided to perform nonregistration operations, such as collection / consolidation system control, backup / restore operation of files in the terminals, and remote power on / off control.

3-4-1. X/Z reporting

X/Z command execution

1. Issuing flash report

X/Z mode → <X> or <X/FOR>, <XX>, <XXX>, <X/KETTEN>

2. Issuing other reports

X/Z mode → D₇D₆D₅D₄D₃D₂D₁ <#-1>

Meaning of the command data

Digit	Value	Meaning
D ₇	0	No edition
	1	Editing by group
	2	Editing by department
	3	Editing by subdepartment
	4	Editing by order character
D ₆	0	No extraction
	1	Inactive (Zero sales)
D ₅	0	No extraction
	1	By Range
	3	Clerk individual
D ₄	0	Execution in X mode
	1	Execution in Z mode
	2	Edit employee data
D ₃	0	Issuing daily area
	1	Issuing periodic 1 area
	2	Issuing periodic 2 area
	3	Issuing daily consolidation area
	4	Issuing periodic 1 consolidation area
	5	Issuing periodic 2 consolidation area
D ₂ D ₁	71	Flash
	00 ~ 09	Batch report 1 ~ 10
	11	Fixed totalizer
	12	Transaction
	14	PLU
	64	PLU stock
	13	Subdepartment
	15	Department
	16	Group
	17	Clerk
	19	Time zone
	20	Monthly
	25	Open check
	28	Table analysis
	58	Electronic Journal
	91	Electronic journal (search by date and consecutive number)
	22	Void reason
	24	Hourly / Labor
	29	Employee
	29	Employee activity
	31	Hourly item
52	Customer group	
	(future use)	
67	IDC (1) clear	
68	IDC (2) clear	
69	IDC (3) clear	

3-4-2. X/Z collection / consolidation

X/Z collection / consolidation execution

Inline X/Z mode → D₁₄D₁₃D₁₂D₁₁D₁₀D₉D₈D₇D₆D₅D₄D₃D₂D₁ <#-2> → <ESC>

Meaning of the command data

Digit	Value	Meaning
D ₁₄ ~D ₁₀	11110	Collection
	11111	Consolidation
	11112	Collection and Consolidation
D ₉ D ₈	00	Fixed
D ₇	0	No edition
	1	Editing by group
	2	Editing by department
	3	Editing by subdepartment
	4	Editing by order character
D ₆	0	No extraction
	1	Inactive (Zero sales)
D ₅	0	No extraction
	1	By Range
D ₄	0	Execution in X mode
	1	Execution in Z mode
D ₃	0	Issuing daily area
	1	Issuing periodic 1 area
	2	Issuing periodic 2 area
D ₂ D ₁	00 ~ 09	Batch report 1 ~ 10
	11	Fixed totalizer
	12	Transaction
	14	PLU
	64	PLU stock
	13	Subdepartment
	15	Department
	16	Group
	17	Clerk
	19	Time zone
	20	Monthly
	22	Void reason
	24	Hourly labor
	28	Table analysis
	31	Hourly item
58	Electronic Journal	
	(future use)	

Manager Operation

3-4-3. Remote power control

Remote power control execution

Manager mode → $D_4D_3D_2D_1$ <#-2>

Meaning of the command data

Digit	Value	Meaning
D_4D_3	00	All terminal
	01 ~ 32	Terminal ID of individual terminal
D_2D_1	10	Remote power on
	11	Remote power off

3-5. Data communication system

The following details the inline and online data communication functions available with the QT-6100 system.

3-5-1. Inline / online connectors

With the QT-6100, there are the following inline / online connectors in the bottom of the terminal.

Inline	(Standard)	Ethernet
RS-232C COM1	(Standard)	For MODEM, PC direct connection, or remote printer
RS-232C COM2	(Standard)	For Hand held scanner, Slip printer, or remote printer
RS-232C COM3	(Standard)	For Remote customer display, or remote printer

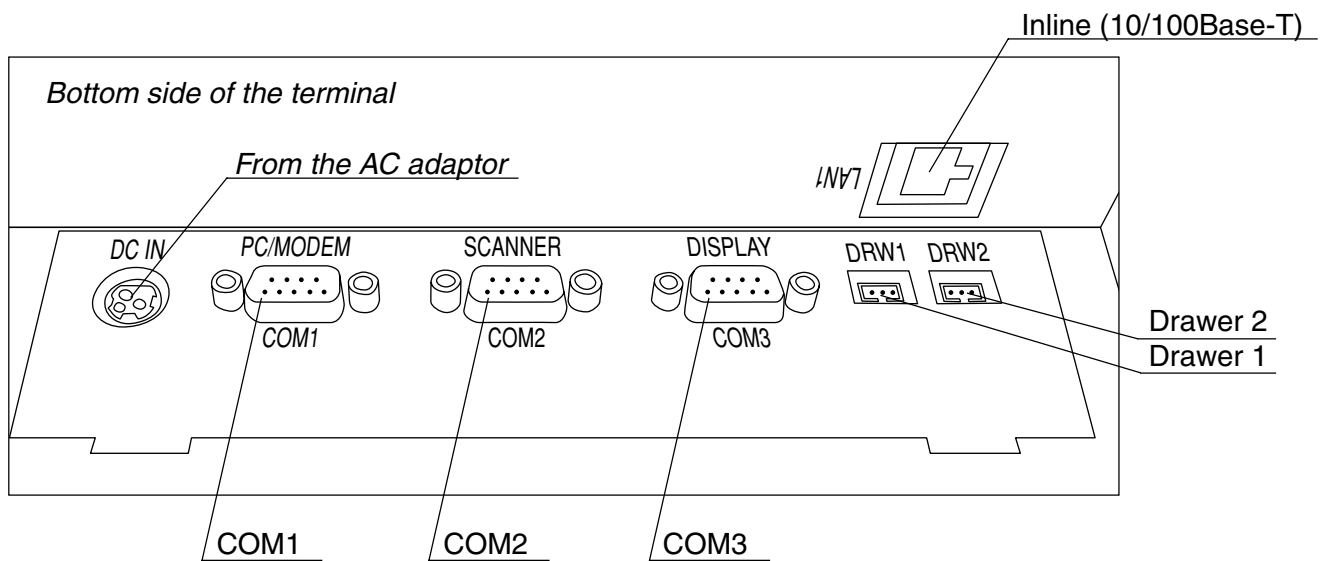

Manager Operation

3-5-2. Hardware interface

3-5-2-1. Inline interface

The maximum inline cable length and the maximum connection unit will be varied by the inline communication speed as shown below figure.

- Using 10BASE-T
Cable length: 100m (hub to terminal, hub to hub)
Maximum 4 hubs in a system.
Maximum cable length between terminal and terminal via hubs is 500m.
- Using 100Base-TX
Cable length: 100m (hub to terminal, hub to hub)
Maximum 2 hubs in a system.
Maximum cable length between terminal and terminal via hubs is 300m.

Terminal to terminal

- 10BASE-T
- 100BASE-TX

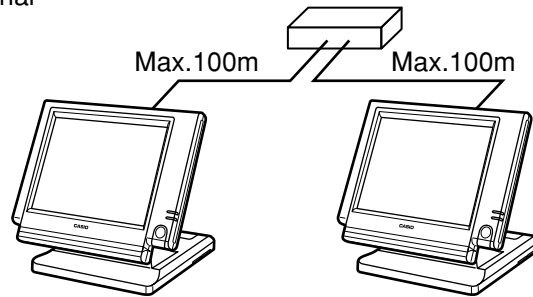

Configuration with Hub

- 10BASE-T

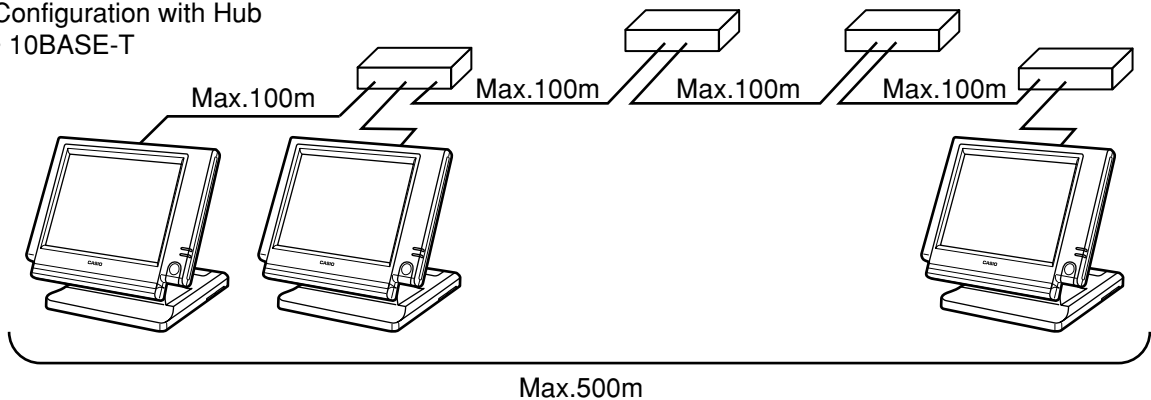

- 100BASE-TX

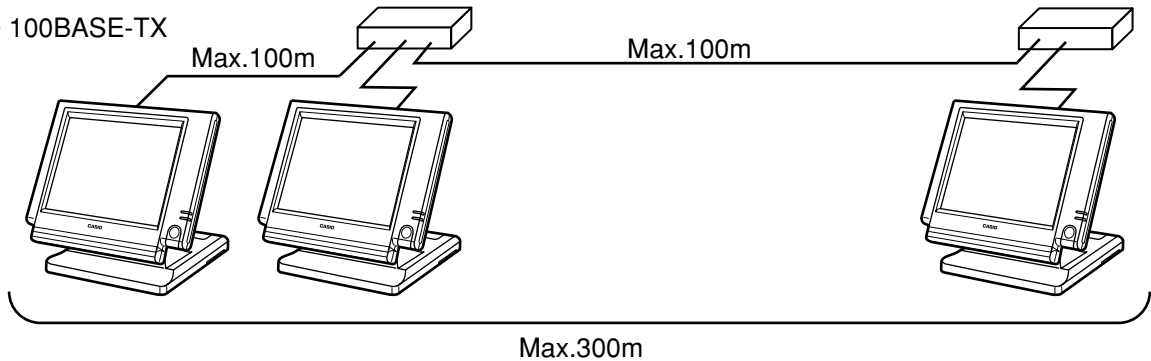

Wireless inline

Wireless inline system requires wireless LAN converter in the QT-6100 terminal and access point.

Via access point and hub, wireless inline terminal can communicate with the wired inline terminal.

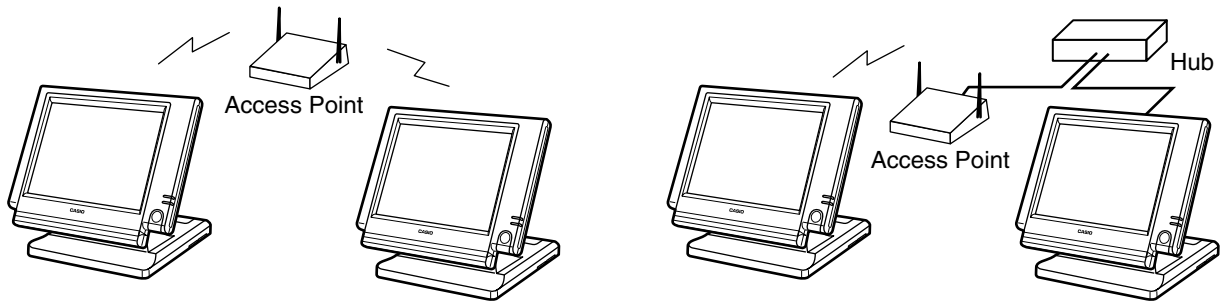

Note

Set unique ESS ID and WEP KEY in the wireless LAN converter for security.

3-5-2-2. Online interface

Only the RS-232C COM 1 port can be connected with a modem or a personal computer.

1) Specification of RS-232C COM 1 port

Communication method: Half duplex communication
 Configuration of connection: Point-to-point
 Line type: Public lines / exclusive lines
 Starting method: Center (host computer) based start up
 Protocol: Async.
 Communication speed: 2400 / 4800 / 9600 / 19200 / 38400 / 57600 / 115200 bps
 Error control: CRC-128 or CRC-1024
 Text length: 128 or 1024 bytes

2) The cable diagram between the terminal and MODEM

3) The cable diagram between the terminal and PC

Terminal (COM 1)		MODEM		Terminal (COM 1)		PC	
Pin No.	Signal name	Signal name	Pin No.	Pin No.	Signal name	Pin No.	Pin No.
3	SD/TDX	SD	2	3	SD/TDX	SD	3
2	RD/RXD	RD	3	2	RD/RXD	RD	2
7	RS/RTS	RS	4	7	RS/RTS	RS	7
8	CS/CTS	CS	5	8	CS/CTS	CS	8
1	CD/DCD	CD	8	1	CD/DCD	CD	1
4	ER/DTR	ER	20	4	ER/DTR	ER	4
6	DR/DSR	DR	6	6	DR/DSR	DR	6
9	CI/RI	CI	22	9	CI/RI	CI	22
5	GND	GND	7	5	GND	GND	5

(DSUB25) (DSUB9)

Manager Operation

3-5-3. Inline / online functions

3-5-3-1. Inline functions

The list below shows the main functions available with the QT-6100 system. In case of these functions below are executed, the satellite terminal can receive these commands even if the satellite terminal is in OFF mode.

- 1) X/Z data collection for each terminal
- 2) X/Z data consolidation for each terminal
- 3) X/Z data collection / consolidation for each terminal
- 4) Program data copy and upload between terminals (auto-program function)

Functions 1), 2) and 3) can only be performed from a terminal that is programmed as master in which consolidation files are allocated.

3-5-3-2. Online functions

The QT-6100 can be controlled from the personal computer by connecting it to RS-232C port 1 (COM1).

In case of sending a command from PC, the terminal can receive this command even if the terminal is in OFF mode.

3-6. Collection / Consolidation system

This section provides the general description of the data collection / consolidation system of the QT-6100. The collection / consolidation system is managed by the master/satellite system using inline network. Installation of any special hardware devices is not required for collection / consolidation as inline interfaces are standard feature. Communication is possible with the connection of inline cable.

In this section, the term “master” means a terminal which collects or consolidates data registered on each terminal (called “satellite”) connected the inline.

The differences between collection and consolidation are as follows.

– Collection

Outputs the data of the master and individual satellite terminals from the master terminal.

– Consolidation

Totals data from the master and satellites, and then output it to a specific device.

– Collection / Consolidation

Collection and consolidation are performed at the same time.

Types of totalizer files

There are following seven types of totalizer files:

– Daily total files

Daily total files accumulate registered data.

– Periodic total 1 files

These files accumulate registered data at the point of sale, and can be reset independently from the daily total files. Therefore, the total data within specific period can be accessed by using these files.

– Periodic total 2 files

These files have same functions as the periodic total 1 files, but can reset independently for getting the different periodic total data within different period.

– Daily consolidation files

These are files to consolidate the daily data.

– Periodic total 1 consolidation files

These are files to consolidate the periodic 1 data.

– Periodic total 2 consolidation files

These are files to consolidate the periodic 2 data.

– Consolidation work files

These files are work files to collect or consolidate the data of daily total, periodic total 1 or periodic total 2 files.

The daily consolidation files, periodic total 1 consolidation files, periodic total 2 consolidation files and consolidation work files must be reserved as work files at the master terminal during collection / consolidation operations.

NOTE:

Only a file with the same number of records as the records of corresponding daily total files need to be reserved. For example, if the number of department is 50, then the same number, 50 records, should be reserved for department of other types.

Manager Operation

File description and number list

File description	Terminal files			Consolidation files			Consolidation work
	Daily total	Periodic 1 total	Periodic 2 total	Daily consolidation	Periodic 1 consolidation	Periodic 2 consolidation	
Fixed totalizer	001	101	201	301	401	501	601
Transaction key	002	102	202	302	402	502	602
Subdepartment	003	103	203	303	403	503	603
PLU	004	104	204	304	404	504	604
Department	005	105	205	305	405	505	605
Group	006	106	206	306	406	506	606
Clerk detail	011	111	211	311	411	511	611
Hourly sales	009	109	209	309	409	509	609
Monthly sales	010	110	210	310	410	510	610
Void table	012	112	212	312	412	512	612
Table analysis	018	118	218	318	418	518	618
Grand total	020	120	220	320	420	520	620
Hourly item	021	121	221	321	421	521	621
Hourly labor	014	114	214	314	414	514	614
(future use)							
Customer group	042	142	242	342	442	542	642
Shift PLU	055	155	255	355	455	555	655

3-6-1. X/Z collection

This function is used to obtain the counters and totals of the individual terminals. For collection results (normal end or error end), the satellite does not print it out on the receipt / journal during X collection. But the results of the Z collection are printed out in the journal during Z collection.

3-6-1-1. X collection processing

X collection processing is performed as the figure shown below.

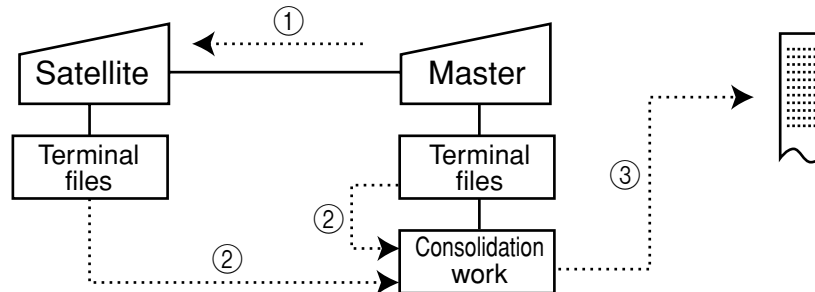

- ① An X collection command is started up from the master terminal.
- ② One objected terminal sends its report data to the consolidation work file of the master.
- ③ Report data from the objected terminal file are printed out on the master's R/J printer.
- ④ After processing of the master terminal completes, the same processes described in the item ① to ③ are executed for the other terminals. Data will be sent without the clerk noticing, even when the satellite in the process of registering.

3-6-1-2. Z collection processing

Z collection processing is performed as the figure shown below.

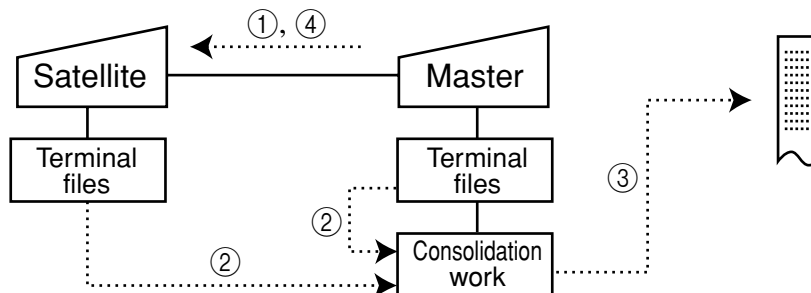

- ① When a Z collection command is started up from the master terminal, the master first locks one objected terminal. (Z lock)
- ② The objected terminal sends its report data to the consolidation work file of the master terminal.
- ③ Report data from the satellite terminal file are printed out on the master R/J printer.
- ④ The same processes described in the item ① to ③ are executed for the other terminals.
- ⑤ After the processing of the master terminal completes, the data of objected terminal file are cleared, and then the Z lock of the objected terminal is released.

NOTE:

- When a Z collection is performed, the consolidation data cannot be output. If output of consolidation data is desired, perform “collection/consolidation” processing described later.
- Even if an error is occurred, or if the processing is terminated, the data to be collected remains as they are, and Z lock statuses are automatically released.

Manager Operation

3-6-1-3. X/Z collection command execution

```

X/Z C01 10-10-01 12:34 000000
-----
      Inline X/Z
      1.Collection
      2.Consolidation
      3.Collection & Consolidation
-----
C01 0.00
  
```

1. Sign on a clerk (if necessary).
2. Press <Inline>.

3. Select "1. Collection" and press the <YES> key.

```

      Collection
      -----
      Collection
      1.Daily X
      2.Periodic(1) X
-----
      Collection
      -----
      Daily X
      1.Batch
      2.Cashier/Clerk
      3.Customer Account
      4.Others
-----
C01 0.00
  
```

4. Select the types and kinds you want to collect.
(Please refer to the X/Z report chapter about the report types and kinds.)

```

      Collection
      -----
      Target ECR
      1.All
      2.Terminal A #01
      3.Terminal B #02
      4.Terminal C --- ← Selected terminal
-----
C01 0.00
  
```

5. Select the target terminal(s).
In case of selecting individual terminal(s), press the <ESC> key when you finish to designate terminal(s).

```

      Collection
      -----
      Inline 11110
      Collection 0
      MC #01 12:30 0021 ← Reset counter
      MC #02 12:32 0022
      MC #03 Error End 0001 ← Error code
-----
C01 0.00
  
```

6. Press the <ESC> key twice to terminate this process.

NOTE:

- If money declaration compulsory is set, enter in drawer amount and press <#> (or <#/NS>) before issuing report.

3-6-2. X/Z consolidation

This function is used to obtain the sum of counters and totals of all objected terminals in the store.

After consolidating data from all objected terminals, the master prints the details on the receipt/journal printer.

Regardless of whether they are in the process of registration, the satellite terminals send data and do not print out the reports, when X consolidation is performed. But, during the Z consolidation, satellites are locked from registrations.

3-6-2-1. X consolidation processing

X consolidation processing is performed as the figure shown below.

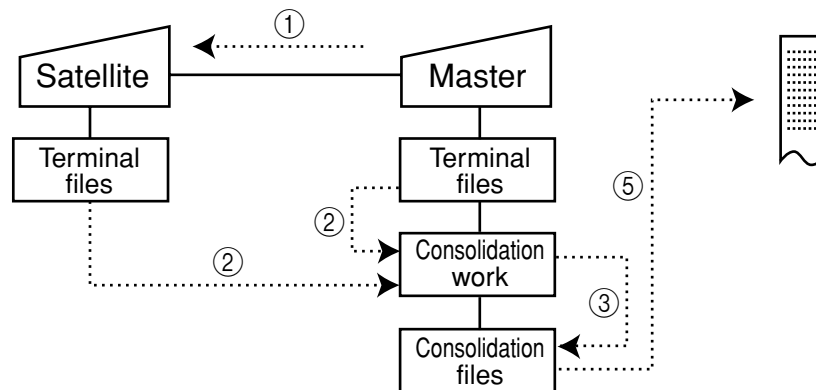

- ① An X consolidation command is started up from the master terminal.
- ② Data of the objected terminal file are sent to the master terminal, and are copied to the consolidation work file.
- ③ The data in the consolidation work file is added to the consolidation file.
- ④ The same process described in item ① to ③ is executed for other terminals.
- ⑤ After the above collection processing is completed for all objected terminals, the data accumulated in the consolidation work file are reported on the master's R/J printer.

3-6-2-2. Z consolidation processing

Z consolidation processing is performed as the figure shown below.

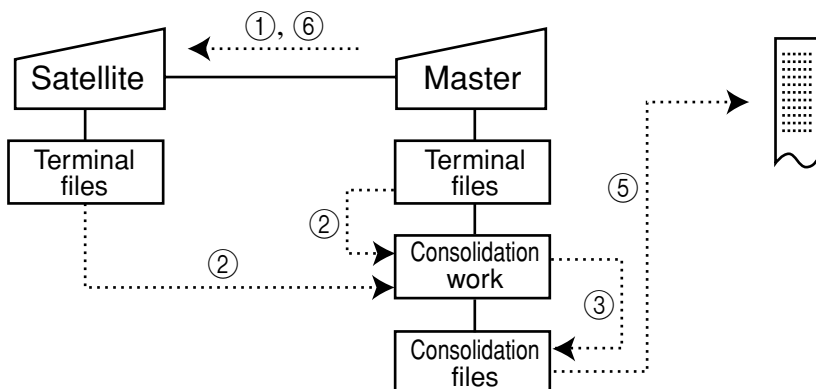

- ① A Z consolidation command is started up from the master terminal. The master first locks an objected terminal. (Z lock)
- ② Data of the objected terminal files are sent to the master terminal, and are copied to the consolidation work file.
- ③ The data in the consolidation work file is added to the consolidation file.
- ④ After the processing of the master terminal completes, the same processes described in item ① to ③ are executed for all other terminals.
- ⑤ The data accumulated in the consolidation file are reported on the master's R/J printer.
- ⑥ After the above collection processing completes for all objected terminals, the files of all objected terminals are cleared, and then satellite's Z lock statuses are released.

Manager Operation

NOTE:

- Even if an error is occurred, or if the processing is terminated, the data to be collected remains as they are, and Z lock statuses are automatically released. Therefore, retrying the same operation can be performed.

3-6-2-3. X/Z consolidation command execution

1. Sign on a clerk (if necessary).
2. Press <Inline> to assign Inline X/Z.

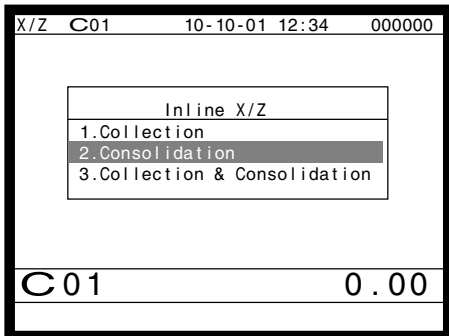

3. Select "2. Consolidation" and press the <YES> key.

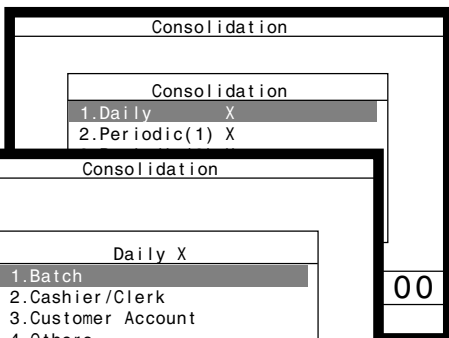

4. Select the types and kinds you want to collect. (Please refer to the X/Z report chapter about the report types and kinds.)

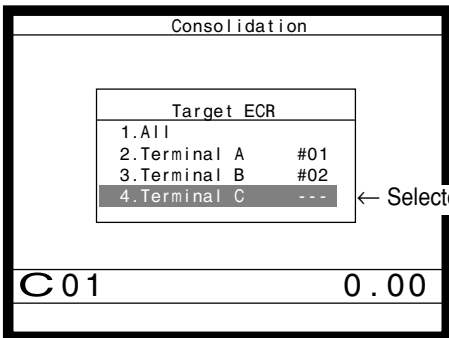
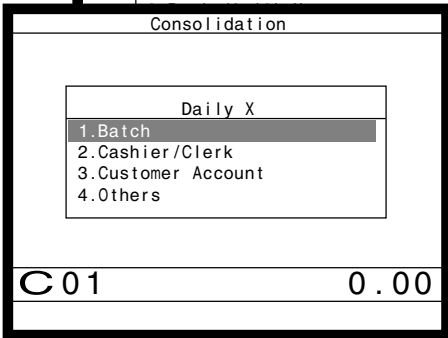

5. Select the target terminal. In case of selecting individual terminal(s), press the <ESC> key when you finish to designate terminal(s).

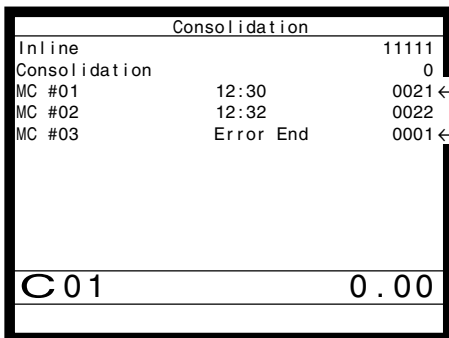

6. Press the <ESC> key twice to terminate this process.

NOTE:

- If money declaration compulsory is set, enter in drawer amount and press <#> (or <#/NS>) before issuing report.

3-6-3. X/Z collection / consolidation

This function is used to obtain the counters and totals of the individual terminals (collection) and of all objected terminals in the store (consolidation) by one procedure. After printing collection report on the master's receipt / journal printer, the master prints the consolidation report. Regardless whether they are in the process of registration, the satellite terminals are send data and do not print out the reports, when X collection / consolidation is performed. But, during the Z collection / consolidation, satellites are locked from registrations.

After consolidating data from all objected terminals, the master prints the details on the receipt / journal printer.

3-6-2-1. X collection/consolidation processing

X collection/consolidation processing is performed as the figure shown below.

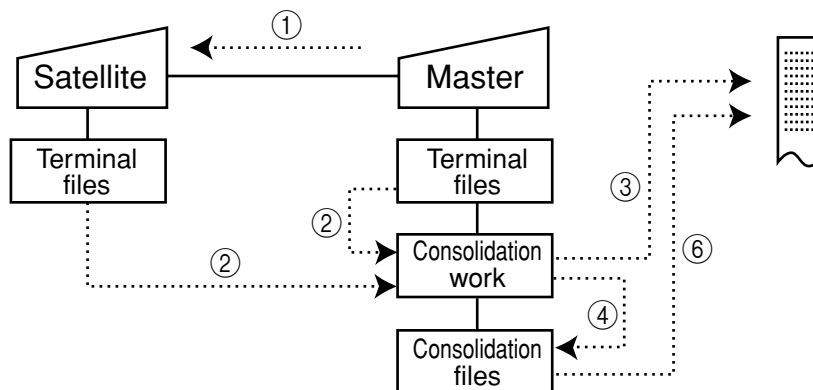

- ① An X collection / consolidation command is started up from the master terminal.
- ② Data of the objected terminal file are sent to the master terminal, and are copied to the consolidation work file.
- ③ The data in the consolidation work file is reported on the master's R/J printer.
- ④ The data in the consolidation work file is added to the consolidation file.
- ⑤ The same process described in item ① to ④ is executed for other terminals.
- ⑥ After the above collection processing is completed for all terminals, the data accumulated in the consolidation file are reported on the master's R/J printer.

Manager Operation

3-6-3-2. Z collection / consolidation processing

Z collection/consolidation processing is performed as the figure shown below.

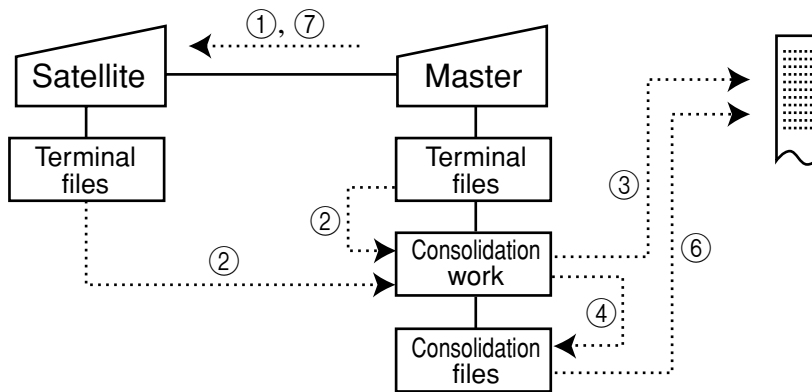

- ① A Z collection / consolidation command is started up from the master terminal.
The master first locks an objected terminal. (Z lock)
- ② Data of the objected terminal file are sent to the master terminal, and are copied to the consolidation work file.
- ③ The data in the consolidation work file are reported on the master's R/J printer.
- ④ The data in the consolidation work file is added to the consolidation file.
- ⑤ After the master terminal's processing completes, the same processes described in item ① to ④ are executed for all other terminals.
- ⑥ The data accumulated in the consolidation file are reported on the master's R/J printer.
- ⑦ After the above collection processing completes for all terminals, the files of all satellite terminals are cleared, and then satellite's Z lock statuses are released.

NOTE:

- Even if an error is occurred, or if the processing is terminated, the data to be collected remains as they are, and Z lock statuses are automatically released. Therefore, retrying the same operation can be performed.

3-6-2-3. X/Z collection / consolidation command execution

1. Sign on a clerk (if necessary).
2. Press the <Inline> key to assign Inline X/Z.

3. Select "3. Collection & Consolidation" and press the <YES> key.

4. Select the types and kinds you want to collect.
(Please refer to the X/Z report chapter about the report types and kinds.)

5. Select the target terminal.
In case of selecting individual terminal(s), press the <ESC> key when you finish to designate terminal(s).

6. Press the <ESC> key twice to terminate this process.

NOTE:

- If money declaration compulsory is set, enter in drawer amount and press <#> (or <#/NS>) before issuing report.

3-7. Auto-programming function

Using the auto programming function makes it possible to save and load the terminal program files. Methods available for saving the terminal program are as follows:

- 1) Saving another terminal connected through inline.
- 2) Saving onto a personal computer connected through online.
- 3) Saving onto a CF card inserted in the CF card slot.

To ensure quick recovery from a corrupted file resulting from user error or system failure, it is recommended that you maintain back up copies of current terminal programs on a file basis.

Terminal program files can be loaded using procedures opposite to those used for saving.

Note:

Data except for program data, such as data in totalizers, counters, and work area, cannot be saved by the auto programming function. (except for copying all terminal files)

Caution:

Do not remove or insert a CF card during sending / receiving data from/to it.

3-7-1. Auto-programming functions

The QT-6100 terminal is capable of saving and loading terminal program files. The terminal program file has the following transfer functions:

- 1) Copy all terminal files (send / receive)
(send: activation by source terminal / receive: activation by target terminal)
This function copies all terminal files (except terminal ID) with counters and totalizers. When a file is not reserved on the target terminal, that file is created automatically.
- 2) Copy all terminal program files (send / receive)
This function copies all terminal files (except terminal ID) without counters and totalizers. When a file is not reserved on the target terminal, the processing for that file is skipped.
- 3) Copy individual terminal program files (send / receive)
This function copies the specific terminal program file (except system work files) without counters and totalizers.
- 4) Copy unit price field of particular files (send / receive)
This function copies the unit price field of specific files (i.e. PLU, PLU 2nd@).

3-7-2. Auto-program operation and CF card utilities

The procedures of auto program function

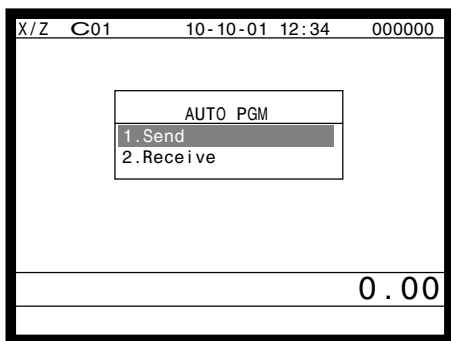

1. Sign on a clerk (if necessary)
2. Press the <Auto PGM> key to assign “AUTO PGM.”

3. Select the appropriate menu you want by following the guidance. The hierarchy of the AUTO PGM menus are described below.

Auto-program menu hierarchy

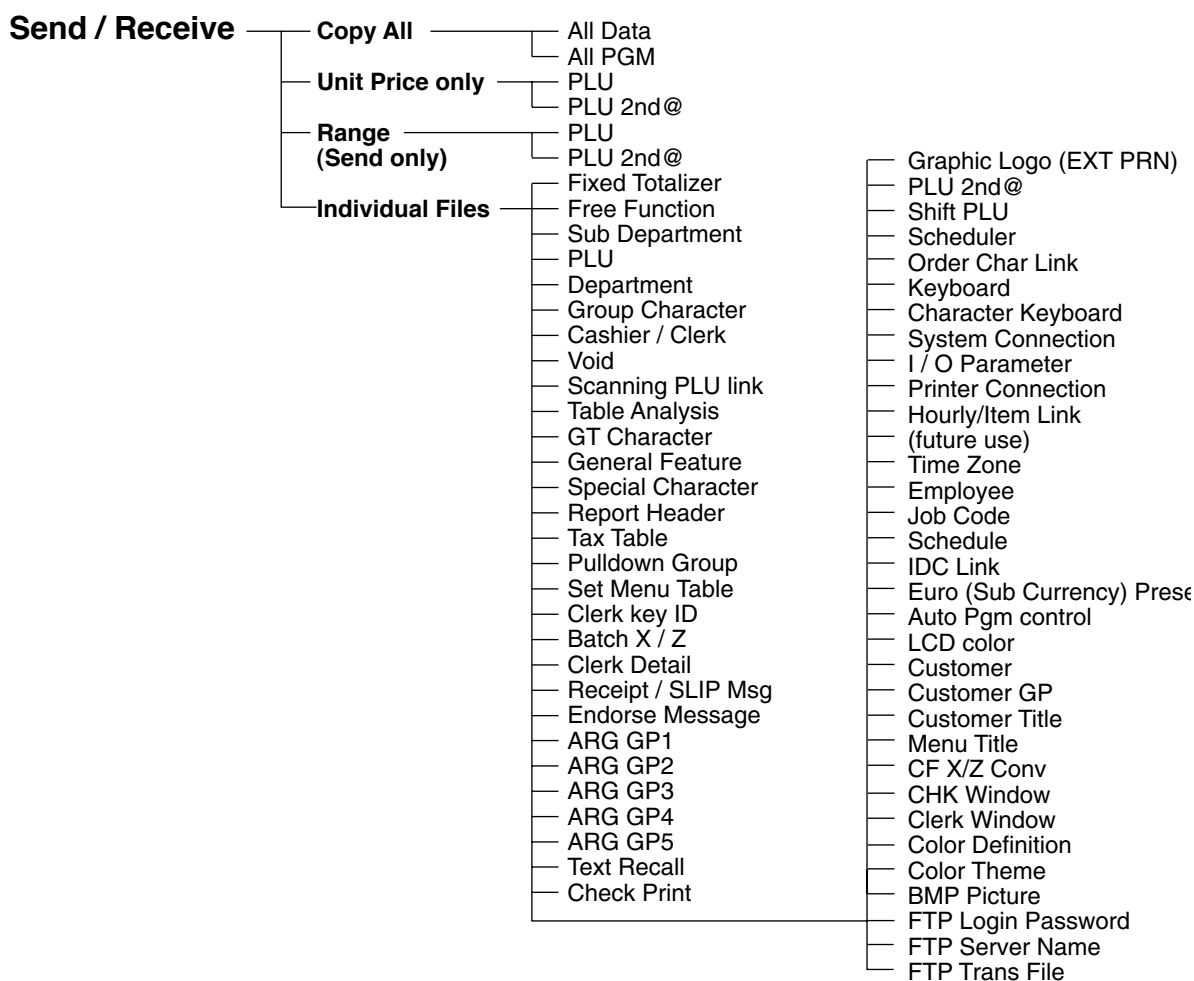

Manager Operation

The procedure of Data Backup to the CF card

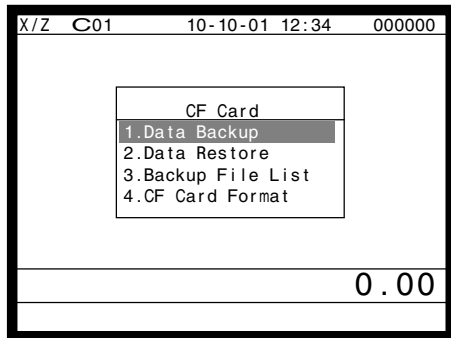

1. Sign on a clerk (if necessary)
2. Press the <CF CARD> key to assign “CF card.”

3. Select the appropriate menu you want by following the guidance. Insert the CF card to the slot securely.
The hierarchy of the Data Backup is described below.

Data Backup menu hierarchy

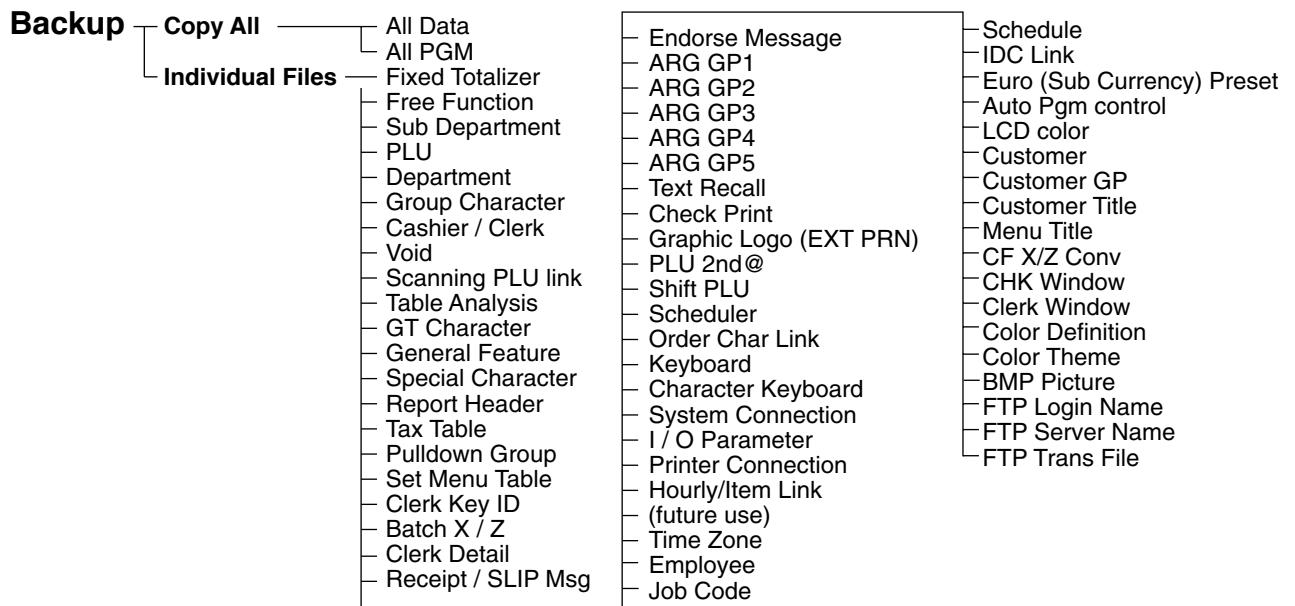

The procedure of Data Restore from the CF card

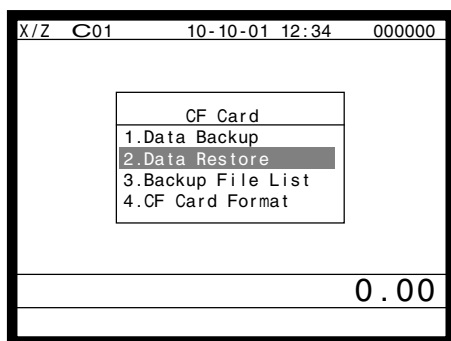

1. Sign on a clerk (if necessary)
2. Press the <CF CARD> key to assign “CF card.”

3. Insert the CF card to the slot securely.
Select “2. Data Restore” and press the <YES> key.

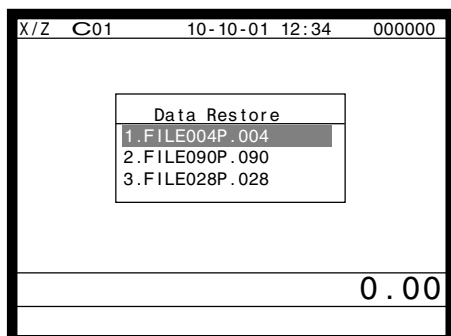

4. Select the appropriate file you want to restore.

The procedures of taking the file list of the CF card and deleting the file

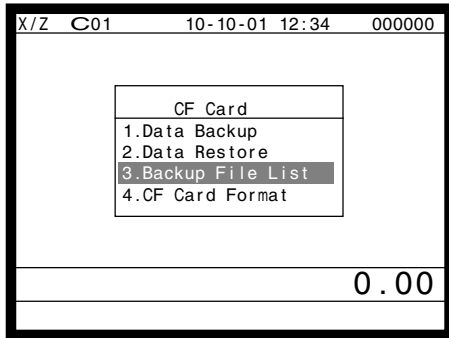

1. Sign on a clerk (if necessary)
2. Press the <CF CARD> key to assign "CF card."

3. Insert the CF card to the slot securely.
Select "3. Backup File List" and press the <YES> key.

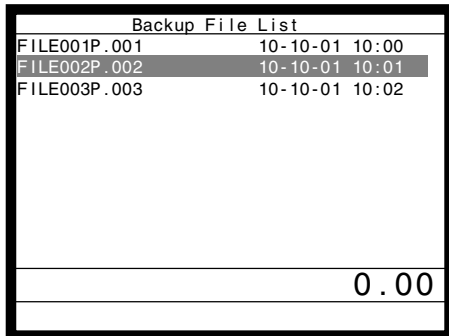

4. In case of deleting a file, select the appropriate file and press the <YES> key.

The procedures of formatting the CF card

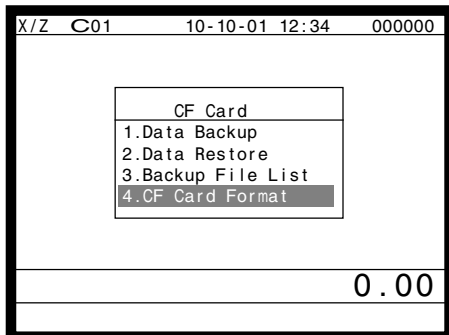

1. Sign on a clerk (if necessary)
2. Press the <CF CARD> key to assign "CF card."

3. Insert the CF card to the slot securely.
Select "4. CF Card Format" and press the <YES> key.

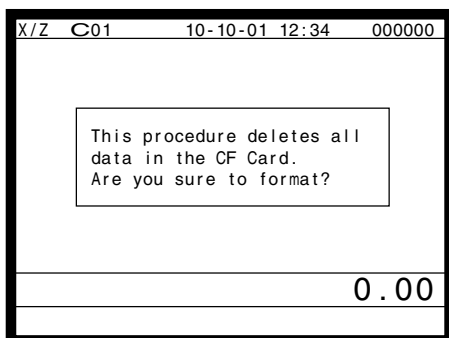

4. Press the <YES> key to continue formatting, <NO> means abortion.

4. Registrations	R-122
4-1. Clerk sign on / off operation	R-122
4-2. Voiding the last registered item (<VOID> key operation)	R-123
4-3. Voiding the previous registered item (<VOID> key operation)	R-124
4-4. Cancelling of all data registered during the transaction	R-124
4-5. Using the list function	R-126
4-6. Using the set menu function and pulldown group function	R-127
4-7. Post entry	R-130
4-8. Separate check	R-131
4-9. Open check	R-132
4-10. Split payment (Dutch account)	R-132
4-11. Media change	R-133
4-12. Eat-in / Takeout	R-134
4-13. Scanning PLU	R-134
4-14. Shift PLU	R-135
4-15. Printing barcode on receipts (UP-360)	R-135
4-16. Round repeat function	R-136
4-17. (future use)	
4-18. Customer	R-138
4-19. Table sharing	R-139
4-20. Order character change	R-139
4-21. Item search	R-139

Registration

4. Registrations

This section describes characteristic registrations of the QT-6100.

Key catch tone, error tone volume can be controlled by the <LEFT/RIGHT ARROW> key.

4-1. Clerk sign on / off operation

The following examples illustrate the clerk sign on / off operation.

- When an i-Button key is used, sign on operation can be performed by attaching the clerk key to the receiver by the appropriate i-Button key.

Note: After initialization, i-Button key ID should be set.

- When a clerk ID number is programmed for the clerk key, sign on operation can be performed by merely pressing the clerk key on the keyboard or in the clerk pop-up window.

It is the same procedure that even clerks are assigned as “clerk”, “cashier” or “manager.”

1) Clerk sign on operation (Clerk key has the clerk number setting.)

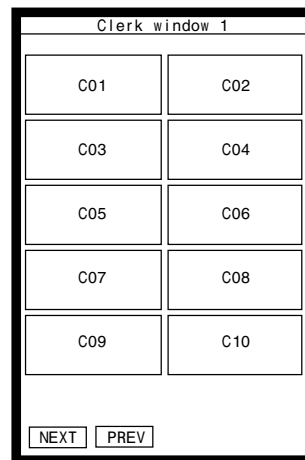
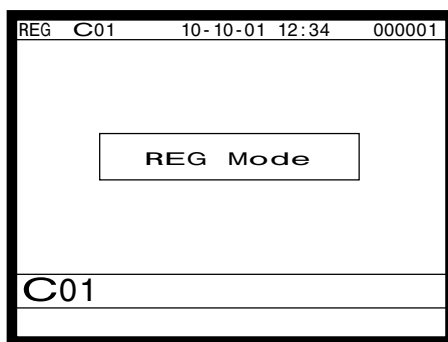

(clerk pop-up window)

1. Just press the appropriate <CLERK> key in the keyboard or in the clerk pop-up window.

2) Clerk sign on operation (Clerk key has no clerk number setting.)

In case of the store has many clerks to control, you need not allocate all clerk keys on the keyboard but allocate a few clerk key and program no clerk number one of the clerk key.



1. Press the <CLERK> key, if you want to display no clerk number entries.

REG	10-10-01 12:34	000001
CLK#	- - * *	
Please sign on.		

2. Enter the appropriate clerk number and press the <CLERK> key.

3) Clerk sign off operation

REG C01	10-10-01 12:34	000001
0.00		
Please sign on.		

1. Enter "0" and press the <CLERK> key.

4-2. Voiding the last registered item (<VOID> key operation)

Use the <VOID> key to cancel a data that has just been registered using a function key. The <VOID> key can be used to cancel data registered using departments, subdepartments, PLUs, partial tenders, or the <PRICE>, <+>, <->, <%+>, <%->, <LOAN> or <PICKUP> key. You can only use the <VOID> key to cancel a registration if you have not yet started registration of the next item.

REG C01	10-10-01 12:34	000001
1 PLU0001		· 1.00
10%		
%-		- 0.10
%-		- 0.10
1 ST		· 0.90

1. Wrong registration is made.

REG C01	10-10-01 12:34	000001
1 PLU0001		· 1.00
VOID		· 0.10
1 ST		· 1.00

2. Press the <VOID> key to cancel the data and reregister the transaction.

Registration

4-3. Voiding the previous registered item (<VOID> key operation)

If data has been registered using a function key and registration of the next item has begun, use the <VOID> key to cancel previous registered data. Entries using departments, subdepartments or PLUs can be cancelled using the <VOID> key.

REG	C01	10-10-01 12:34	000001
1	PLU0001		-1.00
1	PLU0002		-2.00
3	PLU0003		-9.00
1	PLU0004		-4.00
PLU0004			-4.00
6			-16.00

1. Wrong registration is made.

REG	C01	10-10-01 12:34	000001
1	PLU0001		-1.00
1	PLU0002		-2.00
3	PLU0003		-9.00
1	PLU0004		-4.00
PLU0004			-4.00
6			-16.00

2. Press the <UP ARROW> or <DOWN ARROW> key to designate the item registration.

REG	C01	10-10-01 12:34	000001
1	PLU0001		-1.00
1	PLU0002		-2.00
1	PLU0004		-4.00
PLU0003			-9.00
3 ST			-7.00

3. Press the <VOID> key to cancel the item and reregister the transaction.

4-4. Cancelling of all data registered during the transaction

Press the <CANCEL> key to cancel all data registered (except partial tendering) during the transaction. This operation lets you clear registered data and restart from the beginning. The cancel operation must be performed before the transaction is finalized.

REG	C01	10-10-01 12:34	000001
1	PLU0001		-1.00
1	PLU0002		-2.00
3	PLU0003		-9.00
1	PLU0004		-4.00
PLU0004			-4.00
6			-16.00

1. Wrong registration is made.

REG	C01	10-10-01 12:34	000001
1	PLU0001		-1.00
1	PLU0002		-2.00
3	PLU0003		-9.00
1			
Cancel OK?			
PLU0004			-4.00
6			-16.00

2. Press the <CANCEL> key.

REG	C01	10-10-01 12:34	000001
1	PLU0001		-1.00
1	PLU0002		-2.00
3	PLU0003		-9.00
1	PLU0004		-4.00
	CANCEL	
CANCEL			0.00
Please sign on.			

3. Press the <YES> key to cancel the transaction.

Registration

4-5. Using the list function

<LIST> or No. <LIST-#>



Before using the LIST function, the following programs are necessary to use this function.

- 1) Allocating the <LIST> key or the <LIST-#> key (page 20 of the programming manual)
In case of using the <LIST> key, <LIST> key(s) should be allocated on the keyboard before step 2.
- 2) Programming pulldown group (page 28 of the programming manual)
- 3) Programming item price (page 118 of the programming manual)

Normal registration by using the <LIST> and <LIST-#> key

LIST01		0/3-1	
PLU001	PLU002		
PLU003	PLU004		
PLU005	PLU006		
PLU007	PLU008		
PLU009	PLU010		

(List pop-up window)

1. Press the <LIST> key or enter the list No. and press the <LIST-#> key. Then the List pop-up window is opened on the keyboard.

REG	C01	10-10-01	12:34	000001
1	PLU0001			· 10.00
PLU0001				· 10.00
1				· 10.00

2. Select the appropriate item.

Direct selection by using the <LIST> key

REG	C01	10-10-01	12:34	000001
1	PLU0001			· 10.00
PLU0001				· 10.00
1				· 10.00

1. Press the appropriate record number and press the <LIST> key brings direct selection of the item.

4-6. Using the set menu function and pulldown group function

4-6-1. Using the Set Menu function

Before using the set menu function, the following programs are necessary to use this function.

- 1) Programming set menu table (page 29 of the programming manual)
- 2) Programming PLU "Set menu table linking" (page 78 of the programming manual)
- 3) Programming item prices (page 118 of the programming manual)

REG	C01	10-10-01	12:34	000001
1	PLU0001			· 10.00
	PLU0002			
	PLU0003			
	PLU0004			
} Set Menu linked to PLU0001 (select "set menu breakdown printing")				
PLU0001				· 10.00
1				· 10.00

1. Registering a PLU linked to a set menu.

4-6-2. Using the Pulldown group function

PLU (Parent) registration

Child PLU 1	←	Select one of these.
Child PLU 2	←	
Child PLU 3	←	

Before using the pulldown group function, the following programs are necessary to use this function.

- 1) Programming pulldown group table (page 28 of the programming manual)
- 2) Programming PLU "List Link No." (page 78 of the programming manual)
- 3) Programming item prices (page 118 of the programming manual)

REG	C01	10-10-01	12:34	000001
1	PLU0001			· 10.00
PLU0001				· 10.00
1				· 10.00

LIST02	0/3-1
PLU010	PLU011
PLU012	PLU013
(List pop-up window)	

REG	C01	10-10-01	12:34	000001
1	PLU0001			· 10.00
1	PLU0012			· 1.00
PLU0001				· 10.00
2				· 11.00

LIST10	0/3-1
PLU014	PLU015
PLU016	PLU017
(List pop-up window)	

REG	C01	10-10-01	12:34	000001
1	PLU0001			· 10.00
1	PLU0012			· 1.00
1	PLU0015			
PLU0001				· 10.00
2				· 11.00

1. Register the parent (main) PLU. The list linked appears.
2. Select the appropriate (child/grandchild) PLU and press the <YES> key.

Registration

4-6-3. Using the set menu and pulldown group function

Before using the set menu and pulldown group function, the following programs are necessary to use this function.

- 1) Programming set menu table (page 29 of the programming manual)
- 2) Programming pulldown group table (page 28 of the programming manual)
- 3) Allocate the pulldown menu key, if you want to use. (page 20 of the programming manual)
- 4) Programming PLU "Set menu table linking" and "List Link No." (page 78 of the programming manual)
- 5) Programming item prices (page 118 of the programming manual)

The screenshot shows a POS interface with a receipt header: REG C01 10-10-01 12:34 000001. The main display lists items: 1 PLU0001 (price 10.00), PLU0002, PLU0003, and PLU0004. A bracket groups these items with the text "Set Menu linked to PLU0001". A pop-up window titled "LIST01 0/3-1" is overlaid, showing a 2x2 grid of items: PLU010, PLU011, PLU012, and PLU013. Below the main display, the text "(List pop-up window)" is present.

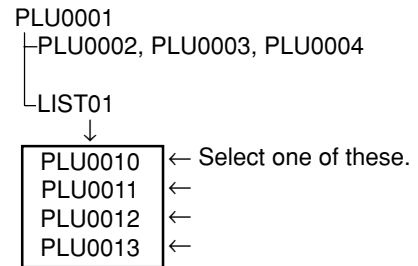

1. Registering a PLU linked to a set menu and pulldown group.

The screenshot shows the same POS interface as before. The main display now includes "1 PLU0010" with a price of 11.00, indicated by an arrow and the text "← Selected in the LIST01". The pop-up window is no longer visible. The receipt total at the bottom shows "PLU0001 · 10.00" and "2 · 11.00".

2. Select the appropriate item and press the <YES> key.
If there are more pulldown groups linked to the PLU, next pulldown group appears on the screen.
You can also select items directly by using the pulldown key.

4-6-4. Using the substitution key

Normally, you can select item(s) in a pulldown group. If the customer requires to take an item from another set menu/pulldown group, the <SUBSTITUTION> key should be used.

The screenshot shows a POS interface with a receipt header: REG C01 10-10-01 12:34 000001. The main display lists items: 1 PLU0020 (price 10.00) and 1 PLU0021 (price 20.00). A pop-up window titled "LIST01 0/3-1" is overlaid, showing a 2x2 grid of items: PLU001, PLU002, PLU003, and PLU004. Below the main display, the text "(List pop-up window)" is present. At the bottom of the screen, the receipt total shows "PLU0021 · 10.00" and "2 · 30.00".

1. A PLU linked to a pulldown group is registered, but no items in the list can be selected.

REG	C01	10-10-01 12:34	0000
1	PLU0020		·10.00
1	PLU0021		·20.00
SUBST.			0.00
	2		·30.00

LIST01		0/3-1	
PLU001	PLU002	PLU003	PLU004

(List pop-up window)

2. Press the <SUBSTITUTION> key.

REG	C01	10-10-01 12:34	000001
1	PLU0020		·10.00
1	PLU0021		·20.00
1	PLU0050		·50.00
PLU0050			·50.00
	3		·80.00

3. Register the appropriate item.

4-6-5. Inner multiplication

Normally, the quantity of list linked PLU or set menu child PLU follows the same quantity as main PLU. But it is possible to register a different number of list linked PLU or child PLU from the number of main PLU.

Before using the inner multiplication, the following program is necessary in addition to the Pulldown Group or Set Menu Table to use this function.

Note) Program "Fast food" in the "Set Menu / Condiment" program (page 39 of the programming manual)

REG	C01	10-10-01 12:34	0000
3	PLU0001		·30.00
PLU0001			·30.00
	3		·30.00

LIST01		0/3-1	
PLU010	PLU011	PLU012	PLU013

(List pop-up window)

1. An multiplication of a PLU is made.

REG	C01	10-10-01 12:34	0000
3	PLU0001		·30.00
X		2	
	3		·30.00

LIST01		0/3-1	
PLU010	PLU011	PLU012	PLU013

(List pop-up window)

2. Enter appropriate quantity and press the <X> key.

Registration

REG	C01	10-10-01 12:34	000
3	PLU0001		.30.00
2	PLU0010		.2.00
PLU0010			.2.00
5			.32.00

LIST01 0/3-1

PLU010	PLU011
PLU012	PLU013

(List pop-up window)

3. Select the appropriate PLU (in case of pulldown group.)

4-7. Post entry

Post entry is used to suspend the selectable item in the pulldown window of a set menu and register the selected item. For example, it is used to register dessert which is included in a set menu. (This function is only effective in check tracking operation.)

4-7-1. To suspend the selection

REG	C01	10-10-01 12:34	0000
1	Lunch menu		.12.00
	Soup		
	Chicken		
	with pepper		
	Sirloin		
	Rare		
	French		
	Pea		
			0.00
1			.12.00

Dessert 0/3-1

Of the day	Cheese cake
A la carte	Beverage

(List pop-up window)



1. Enter the <POST ENTRY> key to suspend the selection.

REG	C01	10-10-01 12:34	000001
1	Lunch menu		.12.00
	Soup		
	Chicken		
	with pepper		
	Sirloin		
	Rare		
	French		
	Pea		
	POST ENTRY ← the suspended item		
			0.00
1			.12.00

2. The key descriptor shows the suspended item.

4-7-2. To register the suspended item

REG	C01	10-10-01 12:34	000001
1	Lunch menu		.12.00
	Soup		
	Chicken		
	with pepper		
	Sirloin		
	Rare		
	French		
	Pea		
	POST ENTRY		
			0.00
1			.12.00

1. Open the check and designate "POST ENTRY" by , . Pressing the <POST ENTRY> key recalls the pulldown menu screen to select items.

4-8. Separate check

Separate check is used to transfer the registered items in the original check to the other check or pick up the registered items in the original check to finalize them.

REG C01	10-10-01 12:34	000001
CHECK No. 222222		
NEW/OLD		222222

1. Enter the check number to which the registered items are transferred and press the <NEW/OLD CHK> key.

# 123456	1
1 PLU0001 · 1.00	
1 PLU0002 · 2.00	
1 PLU0003 · 3.00	
1 PLU0004 · 4.00	
1 PLU0005 · 5.00	
· 15.00	
	· 0.00
OK CANCEL	

2. Press the <SEPARATE CHECK> key and select the original check in the check No. pop-up window. Then the separate check window is opened.

# 123456	1
1 PLU0001 · 1.00	1
1 PLU0003 · 3.00	
1 PLU0005 · 5.00	
· 9.00	
	1 PLU0002 · 2.00
	1 PLU0004 · 4.00
	· 6.00
OK CANCEL	

3. Select the transferring items in the original check column (it is transferred to the other check column).

REG C01	10-10-01 12:34	000001
CHECK No. 222222		
1 PLU0002		· 2.00
1 PLU0004		· 4.00
ST		· 6.00
		0.00
2 ST		· 6.00

4. After selecting items, press the <OK> key in the separate check window to terminate. The selected items are transferred to other check.

4-11. Media change

This key is used to change media in drawer amounts. Pressing this key begins media change operation.

REG	C01	10-10-01	12:34	000001
MEDI A CHG				

1. First press the <MEDIA CHANGE> key.

REG	C01	10-10-01	12:34	000001
MEDI A CHG				
CASH				
				- 10.00
CASH				- 10.00
				· 10.00

2. Enter the in drawer amount to be changed and press the media key to be changed.

REG	C01	10-10-01	12:34	000001
MEDI A CHG				
CASH				
				- 10.00
CHECK				
				· 2.00
CHECK				· 2.00
				· 8.00

3. Enter the amount to change and press the media to change, until the change amount equals to the changed amount.

REG	C01	10-10-01	12:34	000001
MEDI A CHG				
CASH				
				- 10.00
CHECK				
				· 2.00
CREDIT				
				· 8.00
CREDIT				· 8.00

4-14. Shift PLU

This key is used to shift a flat PLU key to the n-th (n = 1 ~ 8) level.
 Before using this function, you should allocate the shift PLU file (file-055), allocate the <SHIFT PLU> keys, and program the shift level (1 ~ 8) to each <SHIFT PLU> key. Since the shift PLU file has 7 (level 2 ~ 8) unit prices, counters and totalizers, you can see the sales quantity / amount of an item by size (S, M, L), quantity etc.
 Shift PLU and 2nd @ are incompatible.

Registration example

REG	C01	10-10-01 12:34	000001
1	PLU0001		·1.00
1	PLU0001		·2.00
1	PLU0001		·3.00
CASH			·6.00

- | | |
|-----------------------|---------------------------------------|
| | OPERATION |
| 1. Register <PLU0001> | <PLU0001> |
| level-2 200 <PLU0001> | <SHIFT PLU (level2)>
200 <PLU0001> |
| level-3 <PLU0001> | <SHIFT PLU (level3)>
<PLU0001> |
| | <CASH> |

4-15. Printing barcode on receipts (UP-360)

This function is used for registering old check by scanning the barcode on the new balance receipt or issuing guest receipt by scanning the barcode on the finalizing receipt.

Example of receipt image

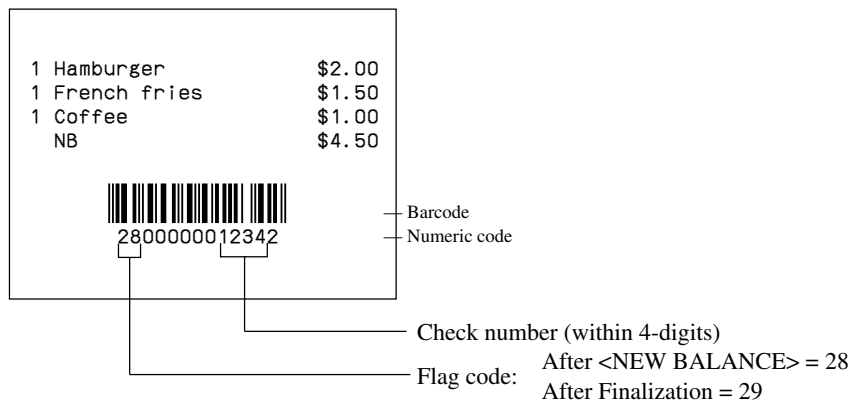

Registration

4-16. Round repeat function

This function is used for repeating registered items of the last receipt finalized by <NEW BALANCE> key in check tracking system or clerk interrupt operation.

REG	C01	10-10-01 12:34	000001
CHECK No. 1111			
1	PLU0001		· 1.00
1	PLU0002		· 2.00
1	PLU0003		· 3.00
	SRVC TL		· 6.00
SRVC TL			· 6.00

1. To issue the original receipt.
1111 <NEW/OLD>
<PLU0001>
<PLU0002>
<PLU0003>
<NEW BALANCE>

REG	C01	10-10-01 12:34	000001
CHECK No. 1111			
1	PLU0001		· 1.00
1	PLU0002		· 2.00
1	PLU0003		· 3.00

NEW / OLD			1111
3 ST			· 6.00

2. Enter the check number of this receipt and press the <NEW/OLD> key.

REG	C01	10-10-01 12:34	000001
CHECK No. 1111			
1	PLU0001		· 1.00
1	PLU0002		· 2.00
1	PLU0003		· 3.00

1	PLU0001		· 1.00
1	PLU0002		· 2.00
1	PLU0003		· 3.00
	SRVC TL		· 12.00
SRVC TL			· 12.00

3. Press <ROUND REPEAT> to recall the last receipt.

4-17. (future use)

Registration

4-18. Customer

Before using the customer function, the following programs are necessary to use this function.

- 1) Allocating customer file (File-037), customer group file (File-042)
Check index file and check detail file are also necessary.
- 2) Allocating customer ID number key (148), payment key (149), table transfer key (014), deposit key (025): if necessary.
- 3) Program "Customer Control", and "Customer Group", refer to the page 61 of the programming manual.
- 3) Program customer No., name, title, address, etc to the customer file, refer to the page 97 of the reference manual.

Item registration

REG	C01	10-10-01 12:34	000001
1	PLU0001		-1.00
1	PLU0002		-2.00
1	PLU0003		-3.00
	DISC		-0.60
	TBL TRANS		- 5 . 40
TBL TRANS			1

1. Enter customer No. and press the <CUST#> (customer ID No.) key.
2. Perform item registration.
(You can re-enter the customer ID No.)
<PLU0001>
<PLU0002>
<PLU0003>
3. Press the <TABLE TRANSFER> key to finalize the transaction.

Payment (by <DEPOSIT> key)

REG	C01	10-10-01 12:34	000001
1	PLU0001		-1.00
1	PLU0002		-2.00
1	PLU0003		-3.00
	DEPOSTT		-5.00
	DISC		-0.10
	TBL TRANS		- 0 . 90
TBL TRANS			1

1. Enter customer No. and press the <CUST#> (customer ID No.) key.
2. Perform item registration.
3. Enter tendered amount and press the <DEPOSIT-> key.
4. Press the <TABLE TRANSFER> key to finalize the transaction.

Payment (by <PAYMENT> key)

REG	C01	10-10-01 12:34	000001
CUST000 1		1CT	
1	PLU0001		-1.00
1	PLU0002		-2.00
1	PLU0003		-3.00
	DISC		-0.60

	TL		- 0 . 90
	CASH		-6.00
	CG		-0.60
CG			-0.60

1. Press the <PAYMENT> key.
2. Enter customer No. and press the <CUST#> (customer ID No.) key.
3. Perform a finalize operation.

Note:

Pressing the <CUST#> directly shows customer No. and name window to specify the customer. Also you can enter a new customer data here in case of allowing to create a new customer.

4-19. Table sharing

Before using the table sharing function, the following programs are necessary to use this function.

- 1) Allocating table sharing key (261).
- 2) Program to enable table sharing function (refer to the page 40 of the programming manual.)

REG C01	10-10-01 12:34	000001
CHECK No. 01123456		
NEW CHK 01123456		

1. In case of designating the same table (check) No. which has already been occupied, the terminal add the branch No. to the table No. and open this check as a new check.
(The branch No. (01 ~ 99) is added to prefix to the original table No.)
01: branch No.
123456: original table (check) No.

4-20. Order character change

Before using this function, the following programs are necessary.

- 1) Allocating order character file (File-065).
- 2) Allocating order character change key (252).
- 3) Linking order character record No.: if necessary

REG C01	10-10-01 12:34	000001
ORDER CHAR		
1. ORDER CHAR01		
2. ORDER CHAR02		
3. ORDER CHAR03		
4. ORDER CHAR04		
5. ORDER CHAR05		
6. ORDER CHAR06		
7. ORDER CHAR07		
8. ORDER CHAR08		
0.00		

1. By pressing <ORDER CHARACTER CHANGE> key, the order character window appears in the screen.
You can change the appropriate order character in the window.
(If the linking order character record No. is set, the order character is changed to the linking character automatically.)

4-21. Item search

Before using this function, the following programs are necessary.

- 1) Allocating item search key (246).
- 2) Searching range: By group / subdepartment / department and its record No.

REG C01	10-10-01 12:34	000001
Found Items		
1. PLU001		
2. PLU002		
3. PLU003		
4. PLU004		
5. PLU005		
6. PLU006		
7. PLU007		
8. PLU008		
0.00		

1. By pressing <ITEM SEARCH> key, the character program keyboard appears on the screen.
2. You can search the item by entering the item descriptor.

Registration

5. Refund mode operation	R-142
5-1. Selecting REF or REG– mode	R-142

Refund Mode

5. Refund mode operation

The general procedure for entering the REF or REG- mode is as follows.

5-1. Selecting REF or REG- mode

After sign on operation, press the <MODE> key and select the <RF> or <REG-> key to turn that mode.

Refund registration or register minus (REG-) registration starts with this operation.

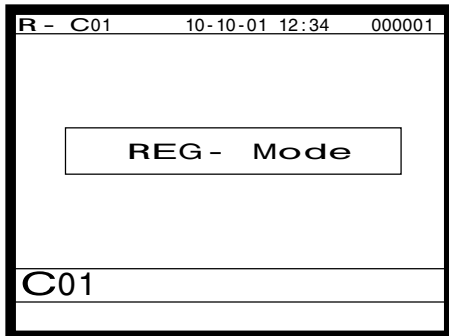
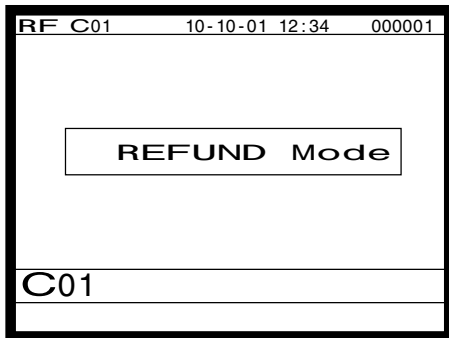
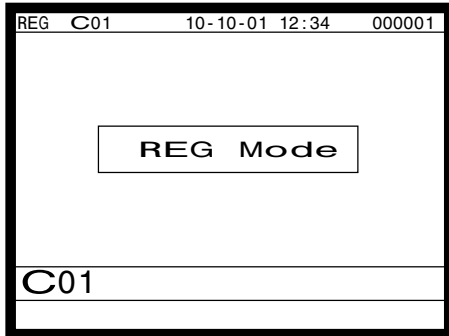

Note: Key operations are similar to that in the register mode.

To avoid miss-registration in the REF or REG- mode, return the mode to the former one immediately.

6. Read and reset operations	R-144
6-1. The procedures of reading or resetting	R-144
6-2. Report sample	R-146

Read and Reset

6. Read and reset operations

By setting the mode to the X or Z, the contents of totalizers and counters are enabled to read. The X mode allows report at any time during business hours. The Z mode is only performed at the end of the business day, since it clears the data stored to the totalizers and counters.

6-1. The procedures of reading or resetting

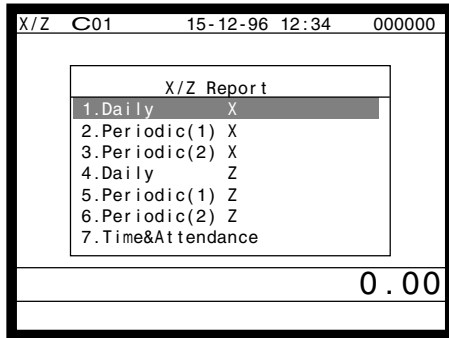

1. Sign on a clerk (if necessary).
2. Press <X/Z MODE> to assign X/Z report.
3. Select the appropriate menu you want by following the guidances. The hierarchy of the X/Z menus are described below.

Refer to page 100 of this manual for X/Z command.

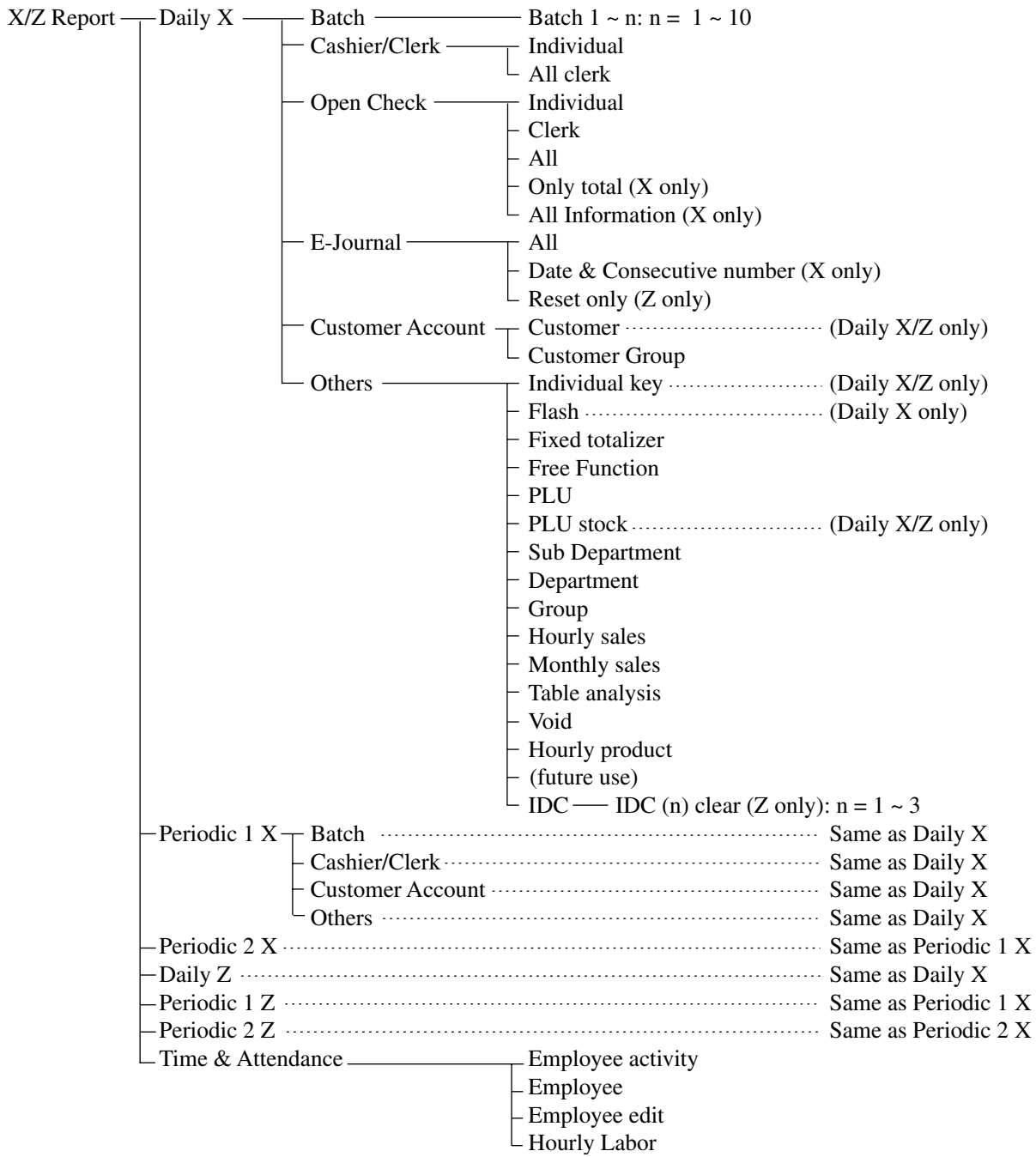

Read and Reset

6-2. Report sample

Cashier / clerk report

Z	0001017	CASHIER/CLERK	123	Mode / Report code / Report title / Z No. (Z only)	
C01				Clerk name / Drawer No.	
GROSS		35	.38.00	Gross title / Counter / Totalizer	} Manager report
NET	No	10	.38.00	Net title / totalizer	
CAID			.35.00	Cash in drawer title / Cash in drawer	
CHID			.3.00	Charge in drawer title / Charge in drawer	
CKID			.0.00	Check in drawer title / Check in drawer	
CRID			.0.00	Credit in drawer title / Credit in drawer	
CASH	No	10	.35.00	Cash key title / Counter / Totalizer	
<hr/>					
C03				Clerk name / Drawer No.	
GROSS		21	.45.00	Gross title / Counter / Totalizer	} Cashier report
NET	No	5	.40.00	Net title / totalizer	
CAID			.35.00	Cash in drawer title / Cash in drawer	
CHID			.3.00	Charge in drawer title / Charge in drawer	
CKID			.0.00	Check in drawer title / Check in drawer	
CRID			.0.00	Credit in drawer title / Credit in drawer	
CASH	No	10	.35.00	Cash key title / Counter / Totalizer	
<hr/>					
C10				Clerk name / Drawer No.	
GROSS		10	.18.00	Gross title / Counter / Totalizer	} Clerk report
NET	No	8	.18.00	Net title / totalizer	
CAID			.15.00	Cash in drawer title / Cash in drawer	
CHID			.3.00	Charge in drawer title / Charge in drawer	
CKID			.0.00	Check in drawer title / Check in drawer	
CRID			.0.00	Credit in drawer title / Credit in drawer	
CASH	No	5	.15.00	Cash key title / Counter / Totalizer	

Individual key

Z	0001095			Mode / Report code
CASH	No	11	.38.00	Function key descriptor / Counter / Totalizer
CHECK	No	0	.0.00	
CREDIT	No	1	.12.00	
ADD CHK	No	0		
<hr/>				
TL		12	.50.00	TL descriptor / Counter / Totalizer

Flash

X	0000071	FLASH		Mode / Report code / Report title
NET	No	11	.38.00	Net sales title / Counter / Totalizer
CAID			.35.00	Cash in drawer title / Cash in drawer
CHID			.0.00	Charge in drawer title / Charge in drawer
CKID			.0.00	Check in drawer title / Check in drawer
CRID			.0.00	Credit in drawer title / Credit in drawer

Fixed totalizer

Z	0001011	FIXED TTL	123	Mode / Report code / Report title / Z No. (Z only)
GROSS		35	·38.00	Gross sales title / Counter / Totalizer
NET	No	11	·38.00	Net sales title / Counter / Totalizer
CAID			·35.00	Cash in drawer title / Cash in drawer
CHID			·0.00	Charge in drawer title / Charge in drawer
CKID			·0.00	Check in drawer title / Check in drawer
CRID			·0.00	Credit in drawer title / Credit in drawer
RF	No	2	·8.00	Refund mode descriptor / Counter / Totalizer
COVER	CT	2		Customer count descriptor / Counter
TA1			·0.00	Taxable amount 1 descriptor / Taxable amount 1
TX1			·0.00	Tax 1 descriptor / Tax 1 amount
EX1			·0.00	Tax exempt 1 descriptor / Tax exempt amount 1
EX9			·0.00	Taxable amount 10 descriptor / Taxable amount 10
TA10			·0.00	Tax 10 descriptor / Tax 10 amount
TX10			·0.00	Tax exempt 10 descriptor / Tax exempt amount 10
EX10			·0.00	Tax exempt 10 descriptor / Tax exempt amount 10
GT1			·1236901437.04	Grand total 1 descriptor / Grand total 1
GT2			·1569567830.40	Grand total 2 descriptor / Grand total 2
GT3			·1325670420.24	Grand total 3 descriptor / Grand total 3
		000001---	>001279	Consecutive No. range

Free function

Z	0001012	FREE FUNCTION	123	Mode / Report code / Report title / Z No. (Z only)
CASH	No	11	·38.00	Transaction key descriptor / Counter / Amount
RC	No	2	·8.00	
PD	No	1	·1.00	

PLU

Z	0001014	PLU	123	Mode / Report code / Report title / Z No. (Z only)
PLU0001		50	·682.55	PLU descriptor / Counter / Amount
DISCOUNT			-1.00	Discount total (can be skipped)
HOUSE BON QTY		12		House Bon quantity (always "0" skipped)
#0001	68.25%			PLU No. (can be skipped) / Sales ratio (can be skipped)
PLU0002		25	·32.00	
HOUSE BON			-5.00	
#0100	3.2%			
TL		75	·714.55	
DISCOUNT			-6.00	
HOUSE BON QTY		12		
	71.45%			

PLU (with shift PLU)

Z	0001014	PLU	123	Mode / Report code / Report title / Z No. (Z only)
PLU0001		50	·682.55	PLU descriptor / Counter / Amount
DISCOUNT			·1.00	Discount total (can be skipped)
HOUSE BON QTY		12		House Bon quantity (can be skipped)
#0001	68.25%			PLU No. (can be skipped) / Sales ratio (can be skipped)
@1		1	·1.23	1st unit price descriptor / Counter / Amount
		2	·2.50	
@8			·6.37	
PLU0002		25	·32.00	
DISCOUNT			·5.00	

Read and Reset

PLU (by range)

X	0010074	PLU			Mode / Report code / Report title / Z No. (Z only)
	#0001-#0002				PLU range
PLU0001			50	·682.55	PLU descriptor / Counter / Amount
DISCOUNT				-1.00	Discount total (can be skipped)
HOUSE BON QTY			12		House Bon quantity (can be skipped)
#0001	68.25%				PLU No. (can be skipped) / Sales ratio (can be skipped)
PLU0002				25	
				·32.00	
DISCOUNT				-5.00	
HOUSE BON QTY			10		
#0002	3.2%				

TL			75	·714.55	
DISCOUNT				-6.00	
HOUSE BON QTY			22		
	71.45%				

PLU (by group / dept / subdept)

X	1000014	PLU			Mode / Report code / Report title / Z No. (Z only)
GROUP01				·01	Group (dept / subdept) title
PLU0001			50	·682.55	PLU descriptor / Counter / Amount
DISCOUNT				-1.00	Discount total (can be skipped)
#0001	68.25%				PLU No. (can be skipped) / Sales ratio (can be skipped)
PLU0002			25	·32.00	
DISCOUNT				-5.00	
#0002	3.2%				

TL			75	·714.55	Total by group (dept / subdept) / Counter / Amount
DISCOUNT				-6.00	
	71.45%				
GROUP02				·02	

PLU0005			1	·2.00	Non Group (dept / subdept) link items
DISCOUNT				-0.00	
#0005	0.2%				

TL			1	·2.00	
DISCOUNT				-0.00	
	0.2%				

PLU (by order character)

X	4000014	PLU			Mode / Report code / Report title / Z No. (Z only)
ORDER01				·01	Order title
PLU0001			50	·682.55	PLU descriptor / Counter / Amount
DISCOUNT				-1.00	Discount total (can be skipped)
#0001	68.25%				PLU No. (can be skipped) / Sales ratio (can be skipped)
PLU0002			25	·32.00	
DISCOUNT				-5.00	
#0002	3.2%				

TL			75	·714.55	Total by order / Counter / Amount
DISCOUNT				-6.00	
	71.45%				
ORDER02				·02	

PLU0005			1	·2.00	Non order character link item
DISCOUNT				-0.00	
#0005	0.2%				

TL			1	·2.00	
DISCOUNT				-0.00	
	0.2%				

PLU zero sales

X	0100014	PLU				Mode / Report code / Report title
PLU0001			0		·0.00	PLU descriptor / Counter / Amount
DISCOUNT					·0.00	
#0001						PLU No. (can be skipped)
PLU0002			0		·0.00	

TL			0		·0.00	
DISCOUNT					·0.00	

PLU zero sales (by group / dept / subdept / order)

X	1100014	PLU				Mode / Report code / Report title
GROUP01				01	Group (dept / subdept / order character) title
PLU0001			0		·0.00	PLU descriptor / Counter / Amount
DISCOUNT					·0.00	
#0001						PLU No. (can be skipped)
PLU0002			0		·0.00	

GROUP02				02	

TL			0		·0.00	
DISCOUNT					·0.00	

TL			0		·0.00	
DISCOUNT					·0.00	

PLU stock / PLU less stock

X	0000064	PLU STOCK				Mode / Report code / Report title / Z No. (Z only)
PLU0001			10		123.45	PLU descriptor / Minimum stock level / Current stock
#0001						PLU No. (can be skipped)
PLU0002			25	*	20	* short stock
#0002						
:						

PLU stock (by range)

X	0010064	PLU STOCK				Mode / Report code / Report title / Z No. (Z only)
#0001-#0002						Range
PLU0001			10		123.45	PLU descriptor / Minimum stock level / Current stock
#0001						PLU No. (can be skipped)
PLU0002			25	*	20	* short stock
#0002						
:						

Read and Reset

PLU stock (by group / dept / subdept / order)

X	1000064	PLU STOCK			Mode / Report code / Report title / Z No. (Z only)
GROUP01	01			Link group (dept / subdept / order) title
PLU0001	10		123.45		PLU descriptor / Minimum stock level / Current stock
#0001					PLU No. (can be skipped)
PLU0002	25	*	20		* short stock
#0002					
		:			

Subdepartment (all)

Z	0001013	SUB DEPT		123	Mode / Report code / Report title / Z No. (Z only)
SUBDEPT01		24		·82.55	Subdepartment descriptor / Counter / Amount
DISCOUNT				-1.00	Discount total (can be skipped)
		70.82%			Sales ratio (can be skipped)
SUBDEPT02		25		·32.00	
DISCOUNT				-2.00	
		27.45%			

TL		151		·156.55	
DISCOUNT				-3.00	
		100.00%			

Subdepartment (by range)

X	0010013	SUB DEPT			Mode / Report code / Report title / Z No. (Z only)
#0001-#0002					Range
SUBDEPT01		24		·82.55	Subdepartment descriptor / Counter / Amount
DISCOUNT				-1.00	Discount total (can be skipped)
		70.82%			Sales ratio (can be skipped)
SUBDEPT02		25		·32.00	
DISCOUNT				-2.00	
		27.45%			

TL		49		·114.55	
DISCOUNT				-3.00	
		98.27%			

Subdepartment (by group / dept)

X	100013	SUB DEPT			Mode / Report code / Report title / Z No. (Z only)
GROUP01	01			Group title
SUBDEPT01		24		·82.55	Subdepartment descriptor / Counter / Amount
DISCOUNT				·1.00	Discount total (can be skipped)
		70.82%			Sales ratio (can be skipped)
SUBDEPT02		25		·32.00	
DISCOUNT				·2.00	
		27.45%			

TL		49		·114.55	
DISCOUNT				·3.00	
		98.27%			

SUBDEPT04		1		·1.00	No group link items
DISCOUNT				·0.00	
		0.87%			

TL		1		·1.00	
DISCOUNT				·0.00	
		0.87%			

Subdepartment zero sales

X	0100013	SUB DEPT		Mode / Report code / Report title	
	SUBDEPT03		0	·0.00	Subdepartment descriptor / Counter / Amount
	DISCOUNT			·0.00	Discount total (can be skipped)
	SUBDEPT04		0	·0.00	
	DISCOUNT			·0.00	

	TL		0	·0.00	
	DISCOUNT			·0.00	

Subdepartment zero sales (by group / dept)

X	1100013	SUB DEPT		Mode / Report code / Report title	
	GROUP01	01	Group title	
	SUBDEPT03		0	·0.00	Subdepartment descriptor / Counter / Amount
	DISCOUNT			·0.00	Discount total (can be skipped)
	SUBDEPT04		0	·0.00	
	DISCOUNT			·0.00	

	TL		0	·0.00	
~~~~~					
	TL		0	·0.00	No group link items total
	DISCOUNT			·0.00	
-----					
	TL		0	·0.00	
	DISCOUNT			·0.00	

### Department (all)

X	0000015	DEPT		Mode / Report code / Report title / Z No. (Z only)	
	DEPT01		24	·82.55	Department descriptor / Counter / Amount
	DISCOUNT			-1.00	Discount total (can be skipped)
			70.82%		Sales ratio (can be skipped)
	DEPT02		25	·32.00	
	DISCOUNT			-2.00	
			27.45%		
~~~~~					
	TL		151	·156.55	
	DISCOUNT			-3.00	
			100.00%		

Department (by range)

X	0010015	DEPT		Mode / Report code / Report title / Z No. (Z only)	
	#0001-#0002			Range	
	DEPT01		24	·82.55	Department descriptor / Counter / Amount
	DISCOUNT			-1.00	Discount total (can be skipped)
			70.82%		Sales ratio (can be skipped)
	DEPT02		25	·32.00	
	DISCOUNT			-2.00	
			27.45%		

	TL		49	·114.55	
	DISCOUNT			-3.00	
			98.27%		

Read and Reset

Department (by group)

X	1000015	DEPT			Mode / Report code / Report title / Z No. (Z only)
GROUP01			01	Group title
DEPT01		24		·82.55	Department descriptor / Counter / Amount
DISCOUNT				-1.00	Discount total (can be skipped)
		70.82%			Sales ratio (can be skipped)
DEPT02		25		·32.00	
DISCOUNT				-2.00	
		27.45%			

TL		49		·114.55	
DISCOUNT				-3.00	
		98.27%			

DEPT04		1		·1.00	No group link items
DISCOUNT				-0.00	
		0.87%			

TL		1		·1.00	
DISCOUNT				-0.00	
		0.87%			

Department zero sales

X	0100015	DEPT			Mode / Report code / Report title
DEPT01		0		·0.00	Department descriptor / Counter / Amount
DISCOUNT				·0.00	Discount total (can be skipped)
DEPT02		0		·0.00	
DISCOUNT				·0.00	

TL		0		·0.00	
DISCOUNT				·0.00	

Department zero sales (by group)

X	1100015	DEPT			Mode / Report code / Report title
GROUP01			01	Group title
DEPT01		0		·0.00	Department descriptor / Counter / Amount
DISCOUNT				·0.00	Discount total (can be skipped)
DEPT02		0		·0.00	
DISCOUNT				·0.00	

TL		0		·0.00	

TL		0		·0.00	No group link items total
DISCOUNT				·0.00	

TL		0		·0.00	
DISCOUNT				·0.00	

Group

X	0000016	GROUP			Mode / Report code / Report title / Z No. (Z only)
GROUP01		6		·163.54	Group descriptor / Counter / Amount
		1.63%			Sales ratio (can be skipped)
GROUP02		2		·2.55	
		0.02%			

TL		8		·166.09	
		1.65%			

Hourly sales

Z	0001019	HOURLY		123	Mode / Report code / Report title / Z No. (Z only)
09:00->10:00			1	·63.54	Time frame / Net counter / Net amount
1.63%	CT		1	·63.54	Sales ratio (can be skipped) / Customer counter / Gross amount
10:00->11:00			2	·122.55	
3.52%	CT		2	·122.55	

Monthly sales

Z	0001020	MONTHLY		123	Mode / Report code / Report title / Z No. (Z only)
7				Day of the month
GROSS			52	·680.57	Gross counter / Gross amount
NET		No	12	·680.50	Net counter / Net amount
8				
GROSS			78	·1,034.59	
NET		No	37	·1,034.57	

TL					
GROSS			130	·1,715.16	
				·13.19	Average gross sales
NET			49	·1,715.07	
				·35.00	Average net sales

Table analysis

Z	0001028	TABLE ANALYSIS		123	Mode / Report code / Report title / Z No. (Z only)
TBL0001		CT	12	·680.57	Table No. / Customer count / Net amount
		50.12%			Sales ratio (can be skipped)
TBL0002		CT	5	·279.56	
		10.04%			

TL		CT	28	·1,267.97	
		60.16%			

Void reason

Z	0001022	VOID REASON		123	Mode / Report code / Report title / Z No. (Z only)
OPE ERR	No		12	·80.50	Void reason / Counter / Amount
OUT OF DATE	No		10	·40.42	
	No		0	·0.00	

Read and Reset

Hourly item

Z	0001031	HOURLY PRODUCT	1234	Mode / Report code / Report title / Z counter (Z only)
09:00->09:30				Time frame
GROSS		1357.956	·2,469.06	Totalizer character / Counter / Amount
NET	40%	No 12	·2,469.06	Sales ratio (Amount / Total amount of each time frame)
PLU0001	40%	1234.5	·1,234.50	
	20%			
	9.89%		·6,172.62	Sales ratio (Amount / Total amount of all time frame) / Total Amount of this time frame
09:30->10:00				
GROSS		1357.956	·2,469.06	
NET	40%	No 12	·2,469.06	
PLU0001	40%	1234.5	·1,234.50	
	20%			
	9.89%		·6,172.62	
19:30->20:00				
GROSS		1357.956	·2,469.06	
NET	40%	No 12	·2,469.06	
PLU0001	40%	1234.5	·1,234.50	
	20%			
	9.89%		·6,172.62	
TL			·62,395.07	Total Amount of all Time frame

Hourly labor report

Z	0001024	HOURLY LABOR	1234	Mode / Report code / Report title / Z counter (Z only)
09:00->09:30 No 2				Time frame / NET counter / NET Amount
	82.62%			NET ratio
COST		00:05	·0.08	Work time / Pay
	0%			Pay ratio
NET SALES/HOUR			·29,628.72	Proceeds per work time
COST/TRANSACTION			·0.04	Wages per transaction
09:30->10:00 No 10				
16:00->16:45 No				
			·0.00	
	0%			
COST		00:01	·0.00	
	0%			
NET SALES/HOUR			·0.00	
COST/TRANSACTION			·0.00	

IDC clear

Z	0001067	IDC(1) Clear	1	Mode / Report code / Report title / Z counter (Z only)
Normal End				Result print

Customer group

X	0000052	CUSTOMER GP		Mode / Report code / Report title / Z counter
CUST GP01	No	1	·12.34	Customer group 01 descriptor / Counter / Totalizer
CUST GP02	No	0	·0.00	

Customer open check (individual)

X	0020047	CUSTOMER		Mode / Report code / Report title / Z counter (Z only)
CUST No.	1 1 1 1 1 1		*	Customer number / * New customer
Mr.				Customer title (Skip if nothing is set.)
John SMITH				Customer's name
BALANCE		- 10.23		Customer's balance
DISCOUNT			.1.23	Discount total
FINALIZED GT		- 316.36		Finalized grand total
DISCOUNT GT			.41.23	Discount grand total
1-2-3 Hon-machi				Address (1) (Skip if nothing is set.)
Shibuya-ku				Address (2) (Skip if nothing is set.)
Tokyo JAPAN				Address (3) (Skip if nothing is set.)
ZIP-123-4567				Address (4) (Skip if nothing is set.)
PHONE No.012345678				Telephone No. (Skip if nothing is set.)

Customer open check (all)

X	0000047	CUSTOMER		Mode / Report code / Report title / Z counter (Z only)
CUST No.	000000 1		*	Customer number / * New customer
Mr.				Customer title (Skip if nothing is set.)
Joseph McAfee				Customer's name
BALANCE		- 10.23		Customer's balance
DISCOUNT			.1.23	Discount total
FINALIZED GT		- 316.36		Finalized grand total
DISCOUNT GT			.41.23	Discount grand total

BUSY				Busy (Occupied) flag
CUST No.	0000022			
BALANCE		- 110.23		
DISCOUNT			.1.23	
FINALIZED GT		- 616.36		
DISCOUNT GT			.41.23	

TL	No	2		No. of customer
BALANCE			.120.46	Customer balance total
DISCOUNT			.2.46	Customer discount total

Customer open check (total only)

X	0040047	CUSTOMER		Mode / Report code / Report title / Z counter (Z only)
TL	No	2		No. of customer
BALANCE			.120.46	Customer balance total
DISCOUNT			.2.46	Customer discount total

Customer open check (all information)

X	0050047	CUSTOMER		Mode / Report code / Report title / Z counter (Z only)
CUST No.	000000 1		*	Customer number / * New customer
Mr.				Customer title (Skip if nothing is set.)
Joseph McAfee				Customer's name
BALANCE		- 10.23		Customer's balance
DISCOUNT			.1.23	Discount total
FINALIZED GT		- 316.36		Finalized grand total
DISCOUNT GT			.41.23	Discount grand total
1-2-3 Hon-machi				Address (1) (Skip if nothing is set.)
Shibuya-ku				Address (2) (Skip if nothing is set.)
Tokyo JAPAN				Address (3) (Skip if nothing is set.)
ZIP-123-4567				Address (4) (Skip if nothing is set.)
PHONE No.012345678				Telephone No. (Skip if nothing is set.)

BUSY				Busy (Occupied) flag
CUST No.	000022			

PHONE No.012345678				

TL	No	2		No. of customer
BALANCE			.120.46	Customer balance total
DISCOUNT			.2.46	Customer discount total

A-1. Function key list R-160

Function key list

A-1. Function key list

Function	Code	Initial character	Function	Code	Initial character
Add check	094	ADD CHK	Operator read / reset	073	OPE X/Z
Arrangement	044	ARG	Order character change	252	ORDER CHAR
Bill copy	047	BILL	Paid out	021	PD
Break-in / out	109	BREAK - IN/OUT	Payment	149	PAYMENT
Cancel	236	CANCEL	Pick up	022	P . UP
Cash amount tendered	001	CASH	Plus	029	+
Charge	002	CHARGE	PLU	048	PLU#
Check endorsement	039	CK . E	Post entry	115	POST ENTRY
Check print	012	CHKP	Premium	030	%+
Check tender	003	CHECK	Price	049	PRC
Clerk number	072	CLK#	Price inquiry	008	PRCINQ
Clerk transfer	013	CLK TRANS	Quantity / for	083	QT
Clock-in / out	108	CLOCK - IN/OUT	Recall	131	RECALL
Coupon	023	COUPON	Receipt	038	RCT
Coupon 2	036	CPN2	Receipt on / off	076	RCT ON/OFF
(future use)			Received on account	020	RC
Credit	004	CREDIT	Refund	033	RF
Cube	090	XXX	Round repeat	116	ROUND REPEAT
Currency exchange	045	CE	Seat number	119	SEAT#
Customer number	148	CUST#	Second unit price	070	2nd@
Declaration	061	DECLA	Selective item subtotal	085	SIST
Department	051	DEPT nn	Separate check	095	SEP CHK
Department number	135	DEPT#	Shift PLU	065	SFT PLU
Deposit	025	DEPOSIT	Slip back feed / release	054	SB/R
Discount	028	%-	Slip feed / release	056	SF/R
Display mode	219	DISP MODE	Slip print	055	SLIP
Dutch account	140	DUTCH	Square	084	XX
Eat-in	128	EAT - IN	Stock inquiry	009	STKINQ
EBT tender	007	EBTTD	Store	130	STORE
Electronic journal display	207	EJ DISP	Subdepartment	133	SUBDEPT nn
Error correct / Void	034	VOID	Subdepartment number	134	SDPT#
First unit price	069	1st@	Substitution	111	SUBST .
Flat PLU	063	PLU nnnn	Subtotal	075	SUBTOTAL
Food stamp status shift	059	F/s	Table number	058	TBL#
Food stamp subtotal	081	FSST	Table sharing	261	TBL SHARE
Food stamp tender	005	FSTD	Table transfer	014	TBL TRANS
House Bon	114	HOUSE BON	Takeout	129	TAKE - OUT
Item search	246	SEARCH	Tax status shift	057	T/S
Ketten Bon	113	X/KETTEN	Taxable amount subtotal	077	TAST
List	136	LIST	Tax exempt	062	EXEMPT
List number	137	LIST#	Text print	011	PRT
Loan	019	LOAN	Text recall	010	CHAR
Location change	260	LOCATION	Tray total	074	TRAY TTL
Lock out unused key	000	NOP	Tip	015	TIP
Media change	118	MEDIA CHG	Validation	037	VLD
Menu shift	064	MENU	VAT	046	VAT
Merchandise subtotal	080	MDST	System keys		
Minus	027	-	Numeric key	000n201	n=1~9, "0"=10
Multiplication	082	X	Clear	202	
New balance	006	NB	Decimal point	098	.
New check	091	NEW CHK	Escape / Skip	211	
New / Old check	093	NEW/OLD	Home position	218	HOME
Normal receipt	016	NRMRCT	Page down	220	PAGE DOWN
No sale	042	NS	Page up	221	PAGE UP
Non-add	040	#	Mode	124	MODE
Non-add / No sale	041	#/NS	Three zero	097	000
Number of customer	043	CT	Two zero	096	00
OBR	103	OBR	Yes	212	
Old check	092	OLD CHK	No	213	
Open	067	OPEN	Left arrow	214	
Open2	068	OPEN2	Right arrow	215	
Open check	117	OPEN CHK	Up arrow	216	
Operator number	078	OPE#	Down arrow	217	

A-2.	File format	R-164
A-2-1.	Fixed totalizer file	R-164
A-2-1-1	Fixed totalizer (daily)	R-164
A-2-1-2	Fixed totalizer (periodic/consolidation)	R-164
A-2-2.	Transaction key file	R-165
A-2-2-1	Transaction key (daily)	R-165
A-2-2-2	Transaction key (periodic/consolidation)	R-165
A-2-3.	Subdepartment file	R-165
A-2-3-1	Subdepartment (daily)	R-165
A-2-3-2	Subdepartment (periodic/consolidation)	R-165
A-2-4.	PLU file	R-166
A-2-4-1	PLU (daily)	R-166
A-2-4-2	PLU (periodic/consolidation)	R-166
A-2-4-3	PLU 2nd@	R-166
A-2-4-4	Scanning PLU link	R-166
A-2-4-5	Shift PLU (daily)	R-167
A-2-4-6	Shift PLU (periodic/consolidation)	R-167
A-2-5.	Department file	R-168
A-2-5-1	Department (daily)	R-168
A-2-5-2	Department (periodic/consolidation)	R-168
A-2-6.	Group file	R-169
A-2-6-1	Group (daily)	R-169
A-2-6-2	Group (periodic/consolidation)	R-169
A-2-7.	Clerk file	R-170
A-2-7-1	Clerk (programming)	R-170
A-2-7-2	Clerk detail (daily, periodic / consolidation)	R-171
A-2-7-3	Clerk detail link	R-171
A-2-7-4	Clerk (i-Button) key ID	R-171
A-2-8.	Hourly sales file	R-172
A-2-8-1	Hourly sales (daily, periodic/consolidation)	R-172
A-2-9.	Monthly sales file	R-172
A-2-9-1	Monthly sales (daily, periodic/consolidation)	R-172
A-2-10.	Hourly item file	R-173
A-2-10-1	Hourly item	R-173
A-2-10-2	Hourly item link (Hourly production link)	R-173
A-2-11.	(future use)	
A-2-12.	IDC file	R-175
A-2-12-1	IDC file (1)	R-175
A-2-12-2	IDC file (2)	R-175
A-2-12-3	IDC file (3)	R-175
A-2-12-4	IDC link	R-175
A-2-13.	Time & Attendance file	R-176
A-2-13-1	Hourly / Labor	R-176
A-2-13-2.	Work time file	R-176
A-2-13-3.	Time zone file	R-177
A-2-13-4.	Employee file	R-177

File Format

A-2-13-5.	Job code file	R-177
A-2-13-6.	Schedule file	R-178
A-2-14.	Void table file	R-179
A-2-14-1	Void table (daily)	R-179
A-2-14-2	Void table (periodic/consolidation)	R-179
A-2-15.	Table analysis file	R-179
A-2-15-1	Table analysis (daily)	R-179
A-2-15-2	Table analysis (periodic/consolidation)	R-179
A-2-16.	Grand total file	R-180
A-2-16-1	Grand total (daily)	R-180
A-2-16-2	Grand total (periodic/consolidation)	R-180
A-2-17.	Customer file	R-181
A-2-17-1	Customer file	R-181
A-2-17-2	Customer group file (daily)	R-181
A-2-17-3	Customer group (periodic/consolidation)	R-181
A-2-17-3	Customer title	R-181
A-2-18.	General control file	R-182
A-2-18-1	General control	R-182
A-2-19.	Special character file	R-183
A-2-19-1	Special character	R-183
A-2-20.	Report header file	R-183
A-2-20-1	Report header	R-183
A-2-21.	Tax table file	R-183
A-2-21-1	Tax table	R-183
A-2-22.	Pulldown group file	R-184
A-2-22-1	Pulldown group	R-184
A-2-23.	Set menu table file	R-184
A-2-23-1	Set menu table	R-184
A-2-24.	Batch X/Z file	R-185
A-2-24-1	Batch X/Z	R-185
A-2-25.	Receipt / Slip message file	R-185
A-2-25-1	Receipt / Slip message	R-185
A-2-26.	Check endorsement message file	R-185
A-2-26-1	Check endorsement message	R-185
A-2-27.	Arrangement file	R-186
A-2-27-1	Arrangement group (1) ~ (5)	R-186
A-2-28.	Character recall file	R-186
A-2-28-1	Character recall	R-186
A-2-29.	Check print file	R-186
A-2-29-1	Check print	R-186
A-2-30.	Graphic logo file	R-186
A-2-30-1	Graphic logo (external printer)	R-186
A-2-31.	Scheduler file	R-187
A-2-31-1	Scheduler	R-187
A-2-32.	Order character file	R-187
A-2-32-1	Order character	R-187

A-2-33.	Euro program file	R-187
A-2-33-1	Euro program file	R-187
A-2-34.	Character conversion for CF file	R-187
A-2-34-1	Character conversion for CF file	R-187
A-2-35.	Check# pop-up window definition file	R-188
A-2-35-1	Check# pop-up window definition file	R-188
A-2-36.	Clerk pop-up window definition file	R-188
A-2-36-1	Clerk pop-up window definition file	R-188
A-2-37.	(future use)	R-188
A-2-38.	System files	R-189
A-2-38-1	Key table	R-189
A-2-38-2	Touch screen key table	R-189
A-2-38-3	System connection table	R-189
A-2-38-4	I/O parameter table	R-190
A-2-38-5	Printer connection table	R-190
A-2-38-6	System error log	R-190
A-2-38-7	Auto program control	R-190
A-2-38-8	LCD color control	R-190
A-2-38-9	Keyboard color definition	R-191
A-2-38-10	Keyboard color theme	R-191
A-2-38-11	Keyboard bitmap image	R-191
A-2-38-12	TCP/IP control	R-192
A-2-38-13	(future use)	R-192
A-2-38-14	FTP Login Name	R-192
A-2-38-15	FTP Server Name	R-192
A-2-38-16	FTP Trans File	R-192

File Format

A-2. File format

A-2-1. Fixed totalizer file

A-2-1-1 Fixed totalizer (daily)

File name: Fixed totalizer (daily)

File No.: 001 Max. allocatable records: 85 (fixed)

0		16		21		26
Character		Counter		Totalizer		

A-2-1-2 Fixed totalizer (periodic/consolidation)

File name: Fixed totalizer (periodic 1)

File No.: 101 Max. allocatable records: 85 (fixed)

File name: Fixed totalizer (periodic 2)

File No.: 201 Max. allocatable records: 85 (fixed)

File name: Fixed totalizer (daily consolidation)

File No.: 301 Max. allocatable records: 85 (fixed)

File name: Fixed totalizer (periodic 1 consolidation)

File No.: 401 Max. allocatable records: 85 (fixed)

File name: Fixed totalizer (periodic 2 consolidation)

File No.: 501 Max. allocatable records: 85 (fixed)

File name: Fixed totalizer (consolidation work)

File No.: 601 Max. allocatable records: 85 (fixed)

0		5		10
Counter		Totalizer		

Rec No.	Contents	Rec No.	Contents	Rec No.	Contents
001	Gross sales total	031	Foreign currency cash in drawer 1	061	Tax exempt 4
002	Net sales total	032	Foreign currency check in drawer 1	062	Taxable amount 5
003	Cash in drawer	033	Foreign currency cash in drawer 2	063	Tax 5
004	Cash declared amount	034	Foreign currency check in drawer 2	064	Tax exempt 5
005	Declared short cash amount	035	Foreign currency cash in drawer 3	065	Taxable amount 6
006	Declared over cash amount	036	Foreign currency check in drawer 3	066	Tax 6
007	Charge in drawer	037	Reduction	067	Tax exempt 6
008	Charge declared amount	038	Item return	068	Taxable amount 7
009	Declared short charge amount	039	Clear count	069	Tax 7
010	Declared over charge amount	040		070	Tax exempt 7
011	Check in drawer	041	Rounding	071	Taxable amount 8
012	Check declared amount	042	ST transfer void	072	Tax 8
013	Declared short check amount	043		073	Tax exempt 8
014	Declared over check amount	044		074	Taxable amount 9
015	Credit in drawer	045		075	Tax 9
016	Credit declared amount	046		076	Tax exempt 9
017	Declared short credit amount	047		077	Taxable amount 10
018	Declared over credit amount	048		078	Tax 10
019	Food stamp in drawer	049		079	Tax exempt 10
020	Food stamp cash change	050	Taxable amount 1	080	Euro cash in drawer
021	EBT in drawer	051	Tax 1	081	Euro charge in drawer
022	EBT cash change	052	Tax exempt 1	082	Euro check in drawer
023	Refund mode total	053	Taxable amount 2	083	Euro credit in drawer
024	Customer count	054	Tax 2	084	Coupon total
025	Average sales per customer	055	Tax exempt 2	085	Money declaration count
026	Check cashing service fee	056	Taxable amount 3		
027	New balance fee	057	Tax 3		
028		058	Tax exempt 3		
029	Clerk commission 1 total	059	Taxable amount 4		
030	Clerk commission 2 total	060	Tax 4		

* Shadowed records are for future use.

A-2-2. Transaction key file

A-2-2-1 Transaction key (daily)

File name: Transaction key (daily)

File No.: 002 Max. allocatable records: 999

0	2	18	25	29	34	39
Function code	Character		Program	@/Rate	Counter	Totalizer

A-2-2-2 Transaction key (periodic/consolidation)

File name: Transaction key (periodic 1)

File No.: 102 Max. allocatable records: 999

File name: Transaction key (periodic 2)

File No.: 202 Max. allocatable records: 999

File name: Transaction key (daily consolidation)

File No.: 302 Max. allocatable records: 999

File name: Transaction key (periodic 1 consolidation)

File No.: 402 Max. allocatable records: 999

File name: Transaction key (periodic 2 consolidation)

File No.: 502 Max. allocatable records: 999

File name: Transaction key (consolidation work)

File No.: 602 Max. allocatable records: 999

0	5	10
Counter	Totalizer	

A-2-3. Subdepartment file

A-2-3-1 Subdepartment (daily)

File name: Subdepartment (daily)

File No.: 003 Max. allocatable records: 99

0	16	23	26	29	32	33	34	36	42	43	48	53	58
Character		Program	Link	@	HALO	Double Bon	Order char. link	Order	Pull-down Group link	Color link	Counter	Totalizer	Discount totalizer

A-2-3-2 Subdepartment (periodic/consolidation)

File name: Subdepartment (periodic 1)

File No.: 103 Max. allocatable records: 99

File name: Subdepartment (periodic 2)

File No.: 203 Max. allocatable records: 99

File name: Subdepartment (daily consolidation)

File No.: 303 Max. allocatable records: 99

File name: Subdepartment (periodic 1 consolidation)

File No.: 403 Max. allocatable records: 99

File name: Subdepartment (periodic 2 consolidation)

File No.: 503 Max. allocatable records: 99

File name: Subdepartment (consolidation work)

File No.: 603 Max. allocatable records: 99

0	5	10	15
Counter	Totalizer	Discount totalizer	

File Format

A-2-4. PLU file

A-2-4-1 PLU (daily)

File name: PLU

File No.: 004 Max. allocatable records: 9999

0	24	31	34	37	40	43	46	48	51	52	53	55
Character		Program	Link	@	Random code	Unit stock	Minimum stock	Set menu link	HALO	Double Bon	Order char. link	Order
55	61	65	70	75	80	85	90	95				
Pull-down Group link	Not used	Stock quantity	Counter	Totalizer	Discount totalizer	Not used	House Bon quantity					

A-2-4-2 PLU (periodic/consolidation)

File name: PLU (periodic 1)

File No.: 104 Max. allocatable records: 9999

File name: PLU (periodic 2)

File No.: 204 Max. allocatable records: 9999

File name: PLU (daily consolidation)

File No.: 304 Max. allocatable records: 9999

File name: PLU (periodic 1 consolidation)

File No.: 404 Max. allocatable records: 9999

File name: PLU (periodic 2 consolidation)

File No.: 504 Max. allocatable records: 9999

File name: PLU (consolidation work)

File No.: 604 Max. allocatable records: 9999

0	5	10	15	20	25	30
Stock quantity	Counter	Totalizer	Discount totalizer	Not used	House Bon quantity	

A-2-4-3 PLU 2nd@

File name: PLU 2nd@

File No.: 054 Max. allocatable records: 9999

0	24	31	34	37	40	43	46	47
Character		Program	Link	2nd@	2nd Q'ty	Unit stock	Not used	Not used

A-2-4-4 Scanning PLU link

File name: Scanning PLU link

File No.: 016 Max. allocatable records: 9999

0	7	9
OBR code	Link PLU rec-#	

A-2-4-5 Shift PLU (daily)

File name: Shift PLU

File No.: 055 Max. allocatable records: 9999

0	3	6	9	12	15	18	21	26	31	36	41	46	51
Unit price shift 2	Unit price shift 3	Unit price shift 4	Unit price shift 5	Unit price shift 6	Unit price shift 7	Unit price shift 8	Counter shift 2	Totalizer shift 2	Counter shift 3	Totalizer shift 3	Counter shift 4	Totalizer shift 4	Counter shift 5
56	61	66	71	76	81	86	91						
Totalizer shift 5	Counter shift 6	Totalizer shift 6	Counter shift 7	Totalizer shift 7	Counter shift 8	Totalizer shift 8							

A-2-4-6 Shift PLU (periodic/consolidation)

File name: Shift PLU (periodic 1)

File No.: 155 Max. allocatable records: 9999

File name: Shift PLU (periodic 2)

File No.: 255 Max. allocatable records: 9999

File name: Shift PLU (daily consolidation)

File No.: 355 Max. allocatable records: 9999

File name: Shift PLU (periodic 1 consolidation)

File No.: 455 Max. allocatable records: 9999

File name: Shift PLU (periodic 2 consolidation)

File No.: 555 Max. allocatable records: 9999

File name: Shift PLU (consolidation work)

File No.: 655 Max. allocatable records: 9999

0	5	10	15	20	25	30	35	40	45	50	55
Counter shift 2	Totalizer shift 2	Counter shift 3	Totalizer shift 3	Counter shift 4	Totalizer shift 4	Counter shift 5	Totalizer shift 5	Counter shift 6	Totalizer shift 6	Counter shift 7	
55	60	65	70								
Totalizer shift 7	Counter shift 8	Totalizer shift 8									

File Format

A-2-5. Department file

A-2-5-1 Department (daily)

File name: Department (daily)

File No.: 005 Max. allocatable records: 99

0	16	23	26	29	32	33	34	36	42	43	48	53	58
Character	Program	Link	@	HALO	Double Bon	Order char. link	Order	Pull-down Group link	Color link	Counter	Totalizer	Discount totalizer	

A-2-5-2 Department (periodic/consolidation)

File name: Department (periodic 1)

File No.: 105 Max. allocatable records: 99

File name: Department (periodic 2)

File No.: 205 Max. allocatable records: 99

File name: Department (daily consolidation)

File No.: 305 Max. allocatable records: 99

File name: Department (periodic 1 consolidation)

File No.: 405 Max. allocatable records: 99

File name: Department (periodic 2 consolidation)

File No.: 505 Max. allocatable records: 99

File name: Department (consolidation work)

File No.: 605 Max. allocatable records: 99

0	5	10	15
Counter	Totalizer	Discount totalizer	

The contents of each field for PLU, department, subdepartment and PLU 2nd@

Program field for PLU, department, subdepartment, PLU 2nd@

Refer to the "Elementary program" on page 173 of the programming manual.

Link field (for PLU, subdepartment, department, PLU 2nd@)

Refer to the "Field 11-066" on page 174 of the programming manual.

Random code field (for PLU)

Refer to the "Field 12-066" on page 174 of the programming manual.

Set menu link field (for PLU)

Refer to the "Field 13-066" on page 174 of the programming manual.

Unit/minimum stock field (for PLU, PLU 2nd@)

Refer to the "Field 14-066-1/-2" on page 174 of the programming manual.

HALO field (for PLU, subdepartment, department)

Refer to the "Field 15-066" on page 174 of the programming manual.

Order character link field (for PLU, subdepartment, department)

Refer to the "Field 16-066" on page 174 of the programming manual.

Double Bon field (for PLU, subdepartment, department)

Refer to the "Field 17-066" on page 175 of the programming manual.

Order character link field (for PLU, subdepartment, department)

Refer to the "Field 20-066" on page 175 of the programming manual.

Pulldown group field (for PLU, subdepartment, department)

Refer to the "Field 21-066" on page 175 of the programming manual.

A-2-6. Group file

A-2-6-1 Group (daily)

File name: Group (daily)

File No.: 006 Max. allocatable records: 99

0	16	21	26
Character	Counter	Totalizer	

A-2-6-2 Group (periodic/consolidation)

File name: Group (periodic 1)

File No.: 106 Max. allocatable records: 99

File name: Group (periodic 2)

File No.: 206 Max. allocatable records: 99

File name: Group (daily consolidation)

File No.: 306 Max. allocatable records: 99

File name: Group (periodic 1 consolidation)

File No.: 406 Max. allocatable records: 99

File name: Group (periodic 2 consolidation)

File No.: 506 Max. allocatable records: 99

File name: Group (consolidation work)

File No.: 606 Max. allocatable records: 99

0	5	10
Counter	Totalizer	

File Format

A-2-7. Clerk file

A-2-7-1 Clerk (programming)

File name: Clerk (programming)

File No.: 007 Max. allocatable records: 99

0	16	19	20	22	27	31	37	43	48	54	
Character	Clerk interrupt check #	Drawer #	Clerk #	Clerk control	Commission rate	Table # range	Menu/@ control	Mode control	Function control (1)		
60	66	72	78	84	90	96					
Function control (2)	Function control (3)	Function control (4)	Function control (5)	Arrangement control	Report control	not used					

Commission rate

Refer to the "Commission rate" on page 159 of the programming manual.

Table range

Refer to the "Table range" on page 159 of the programming manual.

Clerk control

Refer to the "Record 01-067" on page 160 of the programming manual.

Menu/@ control

Refer to the "Record 02-067" on page 161 of the programming manual.

Mode control

Refer to the "Record 03-067" on page 162 of the programming manual.

Function control 1

Refer to the "Record 04-067" on page 163 of the programming manual.

Function control 2

Refer to the "Record 05-067" on page 164 of the programming manual.

Function control 3

Refer to the "Record 06-067" on page 165 of the programming manual.

Function control 4

Refer to the "Record 07-067" on page 166 of the programming manual.

Function control 5

Refer to the "Record 08-067" on page 167 of the programming manual.

Arrangement control

Refer to the "Record 09-067" on page 168 of the programming manual.

Report control

Refer to the "Record 10-067" on page 169 of the programming manual.

A-2-7-2 Clerk detail (daily, periodic / consolidation)

File name: Clerk detail (daily)	File No.: 011	Max. allocatable records: 9801
File name: Clerk detail (periodic 1)	File No.: 111	Max. allocatable records: 9801
File name: Clerk detail (periodic 2)	File No.: 211	Max. allocatable records: 9801
File name: Clerk detail (daily consolidation)	File No.: 311	Max. allocatable records: 9801
File name: Clerk detail (periodic 1 consolidation)	File No.: 411	Max. allocatable records: 9801
File name: Clerk detail (periodic 2 consolidation)	File No.: 511	Max. allocatable records: 9801
File name: Clerk detail (consolidation work)	File No.: 611	Max. allocatable records: 9801

0	5	10
Counter	Totalizer	

A-2-7-3 Clerk detail link

File name: Clerk detail link	File No.: 030	Max. allocatable records: 99
------------------------------	---------------	------------------------------

0	2	4
Record No.	File No.	

A-2-7-4 Clerk (i-Button) key ID

File name: Clerk (i-Button) key ID	File No.: 027	Max. allocatable records: 300
------------------------------------	---------------	-------------------------------

0	12	17
i-Button key ID character	Program	

File Format

A-2-8. Hourly sales file

A-2-8-1 Hourly sales (daily, periodic/consolidation)

File name: Hourly sales (daily)	File No.: 009	Max. allocatable records: 96
File name: Hourly sales (periodic 1)	File No.: 109	Max. allocatable records: 96
File name: Hourly sales (periodic 2)	File No.: 209	Max. allocatable records: 96
File name: Hourly sales (daily consolidation)	File No.: 309	Max. allocatable records: 96
File name: Hourly sales (periodic 1 consolidation)	File No.: 409	Max. allocatable records: 96
File name: Hourly sales (periodic 2 consolidation)	File No.: 509	Max. allocatable records: 96
File name: Hourly sales (consolidation work)	File No.: 609	Max. allocatable records: 96

0	5	10	15
20			
Counter (Net)	Totalizer (Net)	No. of customer	Merchandise subtotal

A-2-9. Monthly sales file

A-2-9-1 Monthly sales (daily, periodic/consolidation)

File name: Monthly sales (daily)	File No.: 010	Max. allocatable records: 32 (fixed)
File name: Monthly sales (periodic 1)	File No.: 110	Max. allocatable records: 32 (fixed)
File name: Monthly sales (periodic 2)	File No.: 210	Max. allocatable records: 32 (fixed)
File name: Monthly sales (daily consolidation)	File No.: 310	Max. allocatable records: 32 (fixed)
File name: Monthly sales (periodic 1 consolidation)	File No.: 410	Max. allocatable records: 32 (fixed)
File name: Monthly sales (periodic 2 consolidation)	File No.: 510	Max. allocatable records: 32 (fixed)
File name: Monthly sales (consolidation work)	File No.: 610	Max. allocatable records: 32 (fixed)

0	5	10	15
20			
Counter (Gross)	Totalizer (Gross)	Counter (Net)	Totalizer (Net)

File Format

A-2-11. (future use)

A-2-12. IDC file

A-2-12-1 IDC file (1)

File name: IDC (1)	File No.: 057	Max. allocatable records: 9999
File name: IDC (1) (daily consolidation)	File No.: 357	Max. allocatable records: 9999
File name: IDC (1) (consolidation work)	File No.: 657	Max. allocatable records: 9999

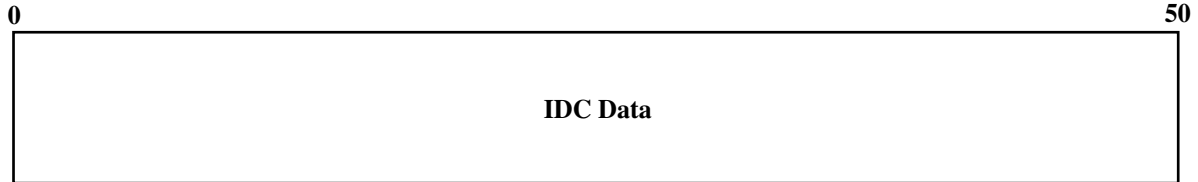

A-2-12-2 IDC file (2)

File name: IDC (2)	File No.: 058	Max. allocatable records: 9999
File name: IDC (2) (daily consolidation)	File No.: 358	Max. allocatable records: 9999
File name: IDC (2) (consolidation work)	File No.: 658	Max. allocatable records: 9999

File structure is same as IDC file (1)

A-2-12-3 IDC file (3)

File name: IDC (3)	File No.: 059	Max. allocatable records: 9999
File name: IDC (3) (daily consolidation)	File No.: 359	Max. allocatable records: 9999
File name: IDC (3) (consolidation work)	File No.: 659	Max. allocatable records: 9999

File structure is same as IDC file (1)

Refer to the page 72 ~ 75 of this manual for each IDC data in detail.

A-2-12-4 IDC link

File name: IDC link	File No.: 804	Max. allocatable records: 999
---------------------	---------------	-------------------------------

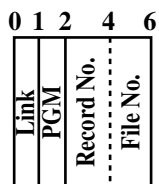

Refer to page 56 of the programming manual for details.

File Format

A-2-13. Time & Attendance file

A-2-13-1 Hourly / Labor

File name: Hourly / Labor

File No.: 014 Max. allocatable records: 96

0	5	10	13	18	21	26
Counter (Net)	Totalizer (Net)	Total labor hours (Fixed)	Total labor cost (Fixed)	Total labor hours (Not fixed)	Total labor cost (Not fixed)	

A-2-13-2. Work time file

File name: Work Time

File No.: 019 Max. allocatable records: 4158

File name: Work Time (daily consolidation)

File No.: 319 Max. allocatable records: 4158

Min. number of files to fix the work time:

The number of employee \times 7 (days) \times 3 (shift) \times 2 (weeks)

Max. allocatable records:

$99 \times 7 \times 3 \times 2 = 4158$

Rec#001~#003: Correspond to Monday of Employee	Rec#001 (First week)
Rec#004~#006: Correspond to Tuesday of Employee	Rec#001 (First week)
Rec#007~#009: Correspond to Wednesday of Employee	Rec#001 (First week)
Rec#010~#012: Correspond to Thursday of Employee	Rec#001 (First week)
Rec#013~#015: Correspond to Friday of Employee	Rec#001 (First week)
Rec#016~#018: Correspond to Saturday of Employee	Rec#001 (First week)
Rec#019~#021: Correspond to Sunday of Employee	Rec#001 (First week)
Rec#020~#024: Correspond to Monday of Employee	Rec#001 (Second week)
Rec#025~#027: Correspond to Tuesday of Employee	Rec#001 (Second week)
Rec#028~#030: Correspond to Wednesday of Employee	Rec#001 (Second week)
Rec#031~#033: Correspond to Thursday of Employee	Rec#001 (Second week)
Rec#034~#036: Correspond to Friday of Employee	Rec#001 (Second week)
Rec#037~#039: Correspond to Saturday of Employee	Rec#001 (Second week)
Rec#040~#042: Correspond to Sunday of Employee	Rec#001 (Second week)

Rec#043~#045: Correspond to Monday of Employee Rec#002 (First week)

•
•
•

0	1	4	6	8	13	15	17	18
Job code	CLOCK-IN date	CLOCK-IN time	CLOCK-OUT time	Cash tip declare	WORK time	BREAK time	EDIT flag	

A-2-13-3. Time zone file

File name: Time zone

File No.: 800 Max. allocatable records: 24

Divide one day into some time zones, and assign the length of one cycle per zone.

0	2	4	6
Start time	End time	Cycle	

Refer to page 52 of the programming manual for details.

A-2-13-4. Employee file

File name: Employee

File No.: 801 Max. allocatable records: 99

0	3	19	24	25	26	27	28	29	30	32	34	36
Employee No.	Character		Social Security No.	PGM	Job code (1)	Job code (2)	Job code (3)	Job code (4)	Clerk No.	Work (1)	Work (2)	Work (3)

Refer to page 54 of the programming manual for details.

A-2-13-5. Job code file

File name: Job code

File No.: 802 Max. allocatable records: 50

0	16	17	20	22
Character		PGM	Pay rate	Over Time Pay Ratio

Refer to page 53 of the programming manual for details.

File Format

A-2-13-6. Schedule file

File name: Schedule

File No.: 803 Max. allocatable records: 2079

Min. number of files to fix the work time: The number of employee \times 7 days \times 3 shift

Max. allocatable records: $99 \times 7 \times 3 = 2079$

Rec#001: Correspond to Monday Shift 1 of Employee Rec#001

Rec#002: Correspond to Monday Shift 2 of Employee Rec#001

Rec#003: Correspond to Monday Shift 3 of Employee Rec#001

Rec#004: Correspond to Tuesday Shift 1 of Employee Rec#001

Rec#005: Correspond to Tuesday Shift 2 of Employee Rec#001

Rec#006: Correspond to Tuesday Shift 3 of Employee Rec#001

•
•

Rec#021: Correspond to Sunday Shift 3 of Employee Rec#001

Rec#022: Correspond to Monday Shift 1 of Employee Rec#002

Rec#023: Correspond to Monday Shift 2 of Employee Rec#002

Rec#024: Correspond to Monday Shift 3 of Employee Rec#002

Rec#025: Correspond to Tuesday Shift 1 of Employee Rec#002

Rec#026: Correspond to Tuesday Shift 2 of Employee Rec#002

Rec#027: Correspond to Tuesday Shift 3 of Employee Rec#002

•
•

0 1 3 5 7 8 9 10 11

Job code
Start time
End time
Break time
Grace before start
Grace after start
Grace before end
Grace after end

A-2-14. Void table file

A-2-14-1 Void table (daily)

File name: Void table (daily)

File No.: 012 Max. allocatable records: 99

0	16	19	24	29
Character	Program	Counter	Totalizer	

Refer to page 47 of the programming manual for details.

A-2-14-2 Void table (periodic/consolidation)

File name: Void table (periodic 1)

File No.: 112 Max. allocatable records: 99

File name: Void table (periodic 2)

File No.: 212 Max. allocatable records: 99

File name: Void table (daily consolidation)

File No.: 312 Max. allocatable records: 99

File name: Void table (periodic 1 consolidation)

File No.: 412 Max. allocatable records: 99

File name: Void table (periodic 2 consolidation)

File No.: 512 Max. allocatable records: 99

File name: Void table (consolidation work)

File No.: 612 Max. allocatable records: 99

0	5	10
Counter	Totalizer	

A-2-15. Table analysis file

A-2-15-1 Table analysis (daily)

File name: Table analysis (daily)

File No.: 018 Max. allocatable records: 99

0	16	19	22	27	32
Character	Min. check #	Max. check #	No. of customer	Totalizer	

A-2-15-2 Table analysis (periodic/consolidation)

File name: Table analysis (periodic 1)

File No.: 118 Max. allocatable records: 99

File name: Table analysis (periodic 2)

File No.: 218 Max. allocatable records: 99

File name: Table analysis (daily consolidation)

File No.: 318 Max. allocatable records: 99

File name: Table analysis (periodic 1 consolidation)

File No.: 418 Max. allocatable records: 99

File name: Table analysis (periodic 2 consolidation)

File No.: 518 Max. allocatable records: 99

File name: Table analysis (consolidation work)

File No.: 618 Max. allocatable records: 99

0	5	10
Counter	Totalizer	

File Format

A-2-16. Grand total file

A-2-16-1 Grand total (daily)

File name: Grand total (daily)

File No.: 020 Max. allocatable records:3 (fixed)

0	16	24
Character	Totalizer	

A-2-16-2 Grand total (periodic/consolidation)

File name: Grand total (periodic 1)

File No.: 120 Max. allocatable records: 3 (fixed)

File name: Grand total (periodic 2)

File No.: 220 Max. allocatable records: 3 (fixed)

File name: Grand total (daily consolidation)

File No.: 320 Max. allocatable records: 3 (fixed)

File name: Grand total (periodic 1 consolidation)

File No.: 420 Max. allocatable records: 3 (fixed)

File name: Grand total (periodic 2 consolidation)

File No.: 520 Max. allocatable records: 3 (fixed)

File name: Grand total (consolidation work)

File No.: 620 Max. allocatable records: 3 (fixed)

0	8
Totalizer	

A-2-17. Customer file

A-2-17-1 Customer file

File name: Customer file

File No.: 037 Max. allocatable records: 200

0	6 7	31	55	79	103	127 133	134 135 140	145	150	170			
Customer number	Title link	Customer name	Customer address 1	Customer address 2	Customer address 3	Customer address 4	Customer phone No.	Customer group link	Status	not used	Finalized GT	Discount GT	Not used

A-2-17-2 Customer group file (daily)

File name: Customer group (daily)

File No.: 042 Max. allocatable records: 20

0	16 17	21 22	38 41	42	58 61	62	78 81	82	98 101 102	107	112	117	122			
Customer group name	Type	Credit limit	Print control	Character	Rate	Tax status	Character	Rate	Tax status	Character	Rate	Tax status	Not used	Counter	Spent total	Not used
				Discount 1	Discount 2	Discount 3	Discount 4									

A-2-17-3 Customer group (periodic/consolidation)

File name: Customer group (periodic 1)

File No.: 142 Max. allocatable records: 99

File name: Customer group (periodic 2)

File No.: 242 Max. allocatable records: 99

File name: Customer group (daily consolidation)

File No.: 342 Max. allocatable records: 99

File name: Customer group (periodic 1 consolidation)

File No.: 442 Max. allocatable records: 99

File name: Customer group (periodic 2 consolidation)

File No.: 542 Max. allocatable records: 99

File name: Customer group (consolidation work)

File No.: 642 Max. allocatable records: 99

0	5	10	15
Counter	Spent total	Not used	

A-2-17-3 Customer title

File name: Customer title

File No.: 123 Max. allocatable records: 9

0	8
Character	

File Format

A-2-18. General control file

A-2-18-1 General control

File name: General control

File No.: 022 Max. allocatable records: 44 (fixed)

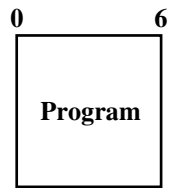

Rec No.	Contents	Reference page (PGM manual)
001	Date order, Monetary mode	129
002	(not used)	---
003	Consecutive number	130
004	Rounding, Tax system	130
005	Receipt control (1)	131
006	Calculation, Operation control	132
007	(not used)	---
008	Report control (1)	133
009	Report control (2)	134
010	Receipt control (2), Till timer	135
011	(not used)	---
012	Report control (3)	136
013	Communication control	136
014	Report control (4)	137
015	Report control (5)	138
016	Time frame	139
017	Receipt control (3), Calculation method	140
018	Slip / Guest receipt control	141
019	Journal control (Electronic journal)	142
020	Message print control	142
021	Order control	143
022	Scanning control	143
023	Australian GST control (1)	143
024	Australian GST control (2)	144
025	Set menu, Condiment	144
026	Check tracking	145
027	Clerk interrupt	146
028	Display control	146
029	Menu sheet control (1)	---
030	(not used)	---
031	Menu sheet control (2)	146
032	Menu sheet control (3)	---
033	Menu sheet control (4)	---
034	Menu sheet control (5)	---
035	Time & Attendance	147
036	Store / Recall range	147
037	Auto check No. range	147
038	(not used)	---
039	Automatic creating customer No. range	---
040	(not used)	---
041	(not used)	---
042	Customer control (1)	148
043	Customer control (2)	148
044	(future use)	---

A-2-19. Special character file

A-2-19-1 Special character

File name: Special character

File No.: 023 Max. allocatable records: 78 (fixed)

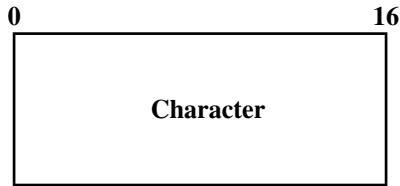

Refer to page 112 of the programming manual for details.

A-2-20. Report header file

A-2-20-1 Report header

File name: Report header

File No.: 024 Max. allocatable records: 40 (fixed)

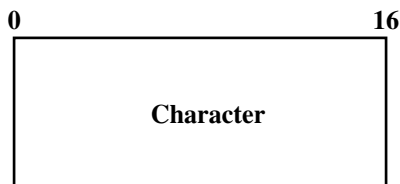

Refer to page 113 of the programming manual for details.

A-2-21. Tax table file

A-2-21-1 Tax table

File name: Tax table

File No.: 025 Max. allocatable records: 10

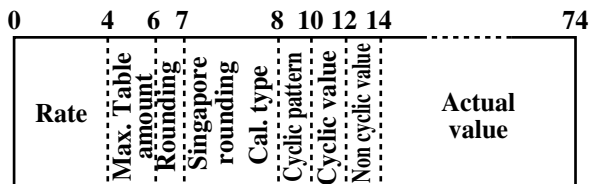

File Format

A-2-22. Pulldown group file

A-2-22-1 Pulldown group

File name: Pulldown group

File No.: 026 Max. allocatable records: 999

0	16	19	20	21	23	25	26	27	43	44	45	46	439	441	443	444	445	461	465
Character	Program	Win color link	Key type	Record No. 1	File No. 1	Key color link 1	not used	Keytop text 1	Record No. 2	File No. 2	Key color link 2	-----	Record No. 20	File No. 20	Key color link 20	not used	Keytop text 20	not used	

A-2-23. Set menu table file

A-2-23-1 Set menu table

File name: Set menu table

File No.: 028 Max. allocatable records: 999

0	2	4	6	8	10	12	14	16	18	20	22	24	26	28	30	32	34	36	38	40	42	44	46	48	50	52	54
Record No. 1	File No. 1	Record No. 2	File No. 2	Record No. 3	File No. 3	Record No. 4	File No. 4	Record No. 5	File No. 5	Record No. 6	File No. 6	Record No. 7	File No. 7	Record No. 8	File No. 8	Record No. 9	File No. 9	Record No. 10	File No. 10	Record No. 11	File No. 11	Record No. 12	File No. 12	Record No. 13	File No. 13	Record No. 14	
56	58	60	62	64	66	68	70	72	74	76	78	80															
File No. 14	Record No. 15	File No. 15	Record No. 16	File No. 16	Record No. 17	File No. 17	Record No. 18	File No. 18	Record No. 19	File No. 19	Record No. 20	File No. 20															

A-2-24. Batch X/Z file

A-2-24-1 Batch X/Z

File name: Batch X/Z

File No.: 029 Max. allocatable records: 10

0	1	2	3	4	5	6	7	8	9	10
Program	Mode	X/Z code (1)	X/Z code (2)	X/Z code (3)	X/Z code (4)	X/Z code (5)	X/Z code (6)	X/Z code (7)	X/Z code (8)	

A-2-25. Receipt / Slip message file

A-2-25-1 Receipt / Slip message

File name: Receipt / Slip message

File No.: 032 Max. allocatable records: 96

0	40
Character	

Refer to page 110 of the programming manual for details.

A-2-26. Check endorsement message file

A-2-26-1 Check endorsement message

File name: Check endorsement message

File No.: 033 Max. allocatable records: 4

0	40
Character	

File Format

A-2-27. Arrangement file

A-2-27-1 Arrangement group (1) ~ (5)

File name: Arrangement group (1)
File name: Arrangement group (2)
File name: Arrangement group (3)
File name: Arrangement group (4)
File name: Arrangement group (5)

File No.: 038 Max. allocatable records: 9999
File No.: 138 Max. allocatable records: 9999
File No.: 238 Max. allocatable records: 9999
File No.: 338 Max. allocatable records: 9999
File No.: 438 Max. allocatable records: 9999

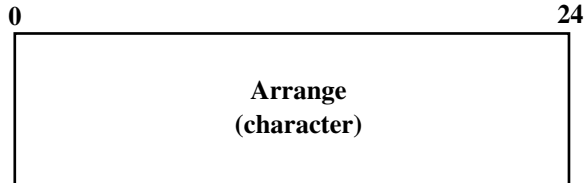

A-2-28. Character recall file

A-2-28-1 Character recall

File name: Character recall

File No.: 039 Max. allocatable records: 9999

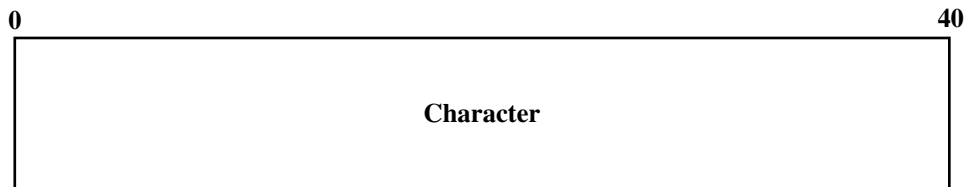

A-2-29. Check print file

A-2-29-1 Check print

File name: Check print

File No.: 041 Max. allocatable records: 9

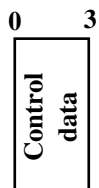

A-2-30. Graphic logo file

A-2-30-1 Graphic logo (external printer)

File name: Graphic logo (external printer)

File No.: 047 Max. allocatable records: 432 (fixed)
or 864 (fixed)

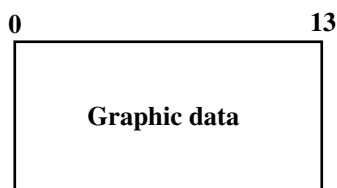

A-2-31. Scheduler file

A-2-31-1 Scheduler

File name: Scheduler

File No.: 062 Max. allocatable records: 99

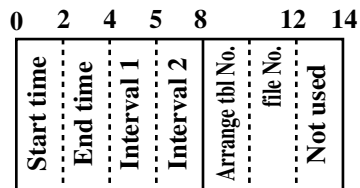

Refer to page 42 of the programming manual for details.

A-2-32. Order character file

A-2-32-1 Order character

File name: Order character

File No.: 065 Max. allocatable records: 99

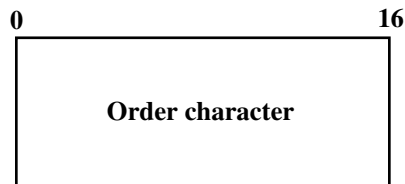

A-2-33. Euro program file

A-2-33-1 Euro program file

File name: Euro program

File No.: 099 Max. allocatable records: 3 (fixed)



Refer to page 155 of the programming manual for details.

A-2-34. Character conversion for CF file

A-2-34-1 Character conversion for CF file

File name: Character conversion for CF

File No.: 087 Max. allocatable records: 1000

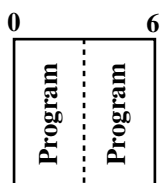

File Format

A-2-35. Check# pop-up window definition file

A-2-35-1 Check# pop-up window definition file

File name: Check# pop-up window definition

File No.: 115 Max. allocatable records: 240 (fixed)

0	3	4	6
Check number	Key type	Bitmap link	

Refer to page 156 of the programming manual for details.

A-2-36. Clerk pop-up window definition file

A-2-36-1 Clerk pop-up window definition file

File name: Clerk pop-up window definition

File No.: 116 Max. allocatable records: 216

0	1	2	3	5
Clerk rec. No.	Key type	Key color link	Bitmap link	

Refer to page 170 of the programming manual for details.

A-2-37. (future use)

A-2-38. System files

A-2-38-1 Key table

File name: Key table

File No.: 074 Max. allocatable records: 2 (fixed)

0	2	4	6	8	10	12	14	16	18	20	22	24	26	28	30	32	34	36	38	40	42	44	46	48
1st Func code	1st Rec No.	2nd Func code	2nd Rec No.	3rd Func code	3rd Rec No.	4th Func code	4th Rec No.	5th Func code	5th Rec No.	6th Func code	6th Rec No.	7th Func code	7th Rec No.	8th Func code	8th Rec No.	1st Char code 1	1st Char code 2	2nd Char code 1	2nd Char code 2	3rd Char code 1	3rd Char code 2	4th Char code 1	4th Char code 2	

Key table record No.	Hard key code
001	not used
002	for Disp on/off

A-2-38-2 Touch screen key table

File name: Key table

File No.: 174 Max. allocatable records: 1950(fixed)

0	2	4	5	6	8	32
Func code	Rec No.	Key type	Color link	Bitmap link	Keypop text	

A-2-38-3 System connection table

File name: System connection table

File No.: 901 Max. allocatable records: 33

0	12	14	16	18	24		
Logical ID	Distinct M/BM	CHK PGM Status	CHK PGM	not used	not used	Check cluster No.	IP address

Description	Choice	Program code																								
Logical ID characters (within 12 characters)	Significant characters	<table border="1"> <tr> <td><input type="checkbox"/></td><td><input type="checkbox"/></td><td><input type="checkbox"/></td><td><input type="checkbox"/></td><td><input type="checkbox"/></td><td><input type="checkbox"/></td> </tr> <tr> <td>D₂₄</td><td>D₂₃</td><td>D₂₂</td><td>D₂₁</td><td>D₂₀</td><td>D₁₉</td> </tr> <tr> <td><input type="checkbox"/></td><td><input type="checkbox"/></td><td><input type="checkbox"/></td><td><input type="checkbox"/></td><td><input type="checkbox"/></td><td><input type="checkbox"/></td> </tr> <tr> <td>D₁₈</td><td>D₁₇</td><td>D₁₆</td><td>D₁₅</td><td>D₁₄</td><td>D₁₃</td> </tr> </table>	<input type="checkbox"/>	<input type="checkbox"/>	<input type="checkbox"/>	<input type="checkbox"/>	<input type="checkbox"/>	<input type="checkbox"/>	D ₂₄	D ₂₃	D ₂₂	D ₂₁	D ₂₀	D ₁₉	<input type="checkbox"/>	<input type="checkbox"/>	<input type="checkbox"/>	<input type="checkbox"/>	<input type="checkbox"/>	<input type="checkbox"/>	D ₁₈	D ₁₇	D ₁₆	D ₁₅	D ₁₄	D ₁₃
<input type="checkbox"/>	<input type="checkbox"/>	<input type="checkbox"/>	<input type="checkbox"/>	<input type="checkbox"/>	<input type="checkbox"/>																					
D ₂₄	D ₂₃	D ₂₂	D ₂₁	D ₂₀	D ₁₉																					
<input type="checkbox"/>	<input type="checkbox"/>	<input type="checkbox"/>	<input type="checkbox"/>	<input type="checkbox"/>	<input type="checkbox"/>																					
D ₁₈	D ₁₇	D ₁₆	D ₁₅	D ₁₄	D ₁₃																					
Terminal: Oneself = 02, Others = 01	Significant numbers	<table border="1"> <tr> <td><input type="checkbox"/></td><td><input type="checkbox"/></td> </tr> <tr> <td>D₁₂</td><td>D₁₁</td> </tr> </table>	<input type="checkbox"/>	<input type="checkbox"/>	D ₁₂	D ₁₁																				
<input type="checkbox"/>	<input type="checkbox"/>																									
D ₁₂	D ₁₁																									
Check tracking master/backup master (program value): Master = 01, Backup master = 02, Self master = 03, Satellite = 00	Significant numbers	<table border="1"> <tr> <td><input type="checkbox"/></td><td><input type="checkbox"/></td> </tr> <tr> <td>D₁₀</td><td>D₉</td> </tr> </table>	<input type="checkbox"/>	<input type="checkbox"/>	D ₁₀	D ₉																				
<input type="checkbox"/>	<input type="checkbox"/>																									
D ₁₀	D ₉																									
Check tracking master/backup master (current value): Master = 01, Backup master = 02, Self master = 03, Satellite = 00	Significant numbers	<table border="1"> <tr> <td><input type="checkbox"/></td><td><input type="checkbox"/></td> </tr> <tr> <td>D₈</td><td>D₇</td> </tr> </table>	<input type="checkbox"/>	<input type="checkbox"/>	D ₈	D ₇																				
<input type="checkbox"/>	<input type="checkbox"/>																									
D ₈	D ₇																									
Always "00000"		<table border="1"> <tr> <td>0</td><td>0</td><td>0</td><td>0</td><td>0</td> </tr> <tr> <td>D₆</td><td>D₅</td><td>D₄</td><td>D₃</td><td>D₂</td> </tr> </table>	0	0	0	0	0	D ₆	D ₅	D ₄	D ₃	D ₂														
0	0	0	0	0																						
D ₆	D ₅	D ₄	D ₃	D ₂																						
always 0	Significant number	<table border="1"> <tr> <td><input type="checkbox"/></td> </tr> <tr> <td>D₁</td> </tr> </table>	<input type="checkbox"/>	D ₁																						
<input type="checkbox"/>																										
D ₁																										

IP address: 192.168.0.0. ~ 192.168.255.255

File Format

A-2-38-4 I/O parameter table

File name: I/O parameter table

File No.: 902 Max. allocatable records: 15

0	5
Program	

Refer to page 48 ~ 50 of the programming manual for details.

A-2-38-5 Printer connection table

File name: Printer connection table

File No.: 903 Max. allocatable records: 99

0	1	13	25	26	27
Type	Main ECR ID	Backup ECR ID	Main printer No.	Backup printer No.	

Refer to page 150 of the programming manual for details.

A-2-38-6 System error log

File name: System error log

File No.: 999 Max. allocatable records: 999

0	2	4	6	7	9	11
Terminal No.	Date	Time	Operation	Error code	Error function	

Refer to page 92, 202, 203 of this manual for details.

A-2-38-7 Auto program control

File name: Auto program control

File No.: 905 Max. allocatable records: 20

0	2	3
File No.	Program	

Refer to page 57 of the programming manual for details.

A-2-38-8 LCD color control

File name: LCD color control

File No.: 906 Max. allocatable records: 99

0	8
Program	

Refer to page 58 of the programming manual for details.

A-2-38-9 Keyboard color definition

File name: Keyboard color definition

File No.: 907 Max. allocatable records: 100

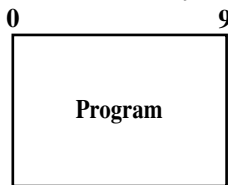

Refer to page 63 of the programming manual for details.

A-2-38-10 Keyboard color theme

File name: Keyboard color theme

File No.: 908 Max. allocatable records: 100

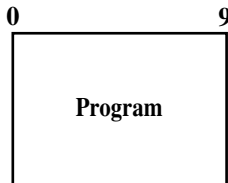

Refer to page 62 of the programming manual for details.

A-2-38-11 Keyboard bitmap image

File name: Keyboard bitmap image

File No.: 910 Max. allocatable records: 60000

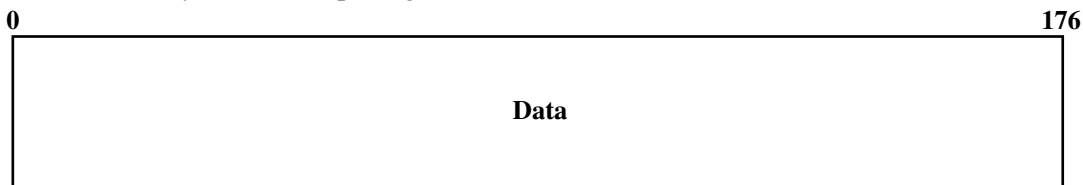

Bitmap file: (in case of creating by PC)

1. Windows bitmap file (1 picture consumes 200 records.)
2. Max. 16.77 million color
3. No. of single key + 2 x No. of double key + 4 x No. of quadruple key is less than or equal to 300.
4. Size

(dots)	Field A	Field B	Field C
Single key	56 x 48	53 x 48	58 x 58
Horizontal double key	118 x 48	113 x 48	130 x 58
Vertical double key	56 x 106	53 x 106	58 x 130
Quadruple key	118 x 106	113 x 106	130 x 130

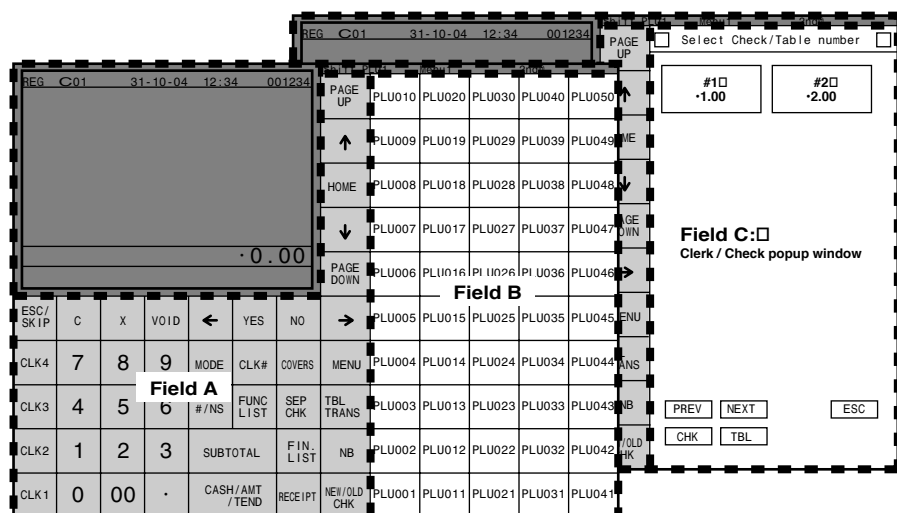

File Format

A-2-38-12 TCP/IP control

File name: TCP/IP control

File No.: 900 Max. allocatable records: 4

0	6
Program	

Refer to page 63 of the programming manual for details.

A-2-38-13 (future use)

A-2-38-14 FTP Login Name

File name: FTP login name

File No.: 911 Max. allocatable records: 10

0	10	20
Login -ID	Password	

A-2-38-15 FTP Server Name

File name: FTP server name

File No.: 912 Max. allocatable records: 9

0	20	26	46	62	78	98
Server title	IP address	not used	Login-ID	Password	Login folder name	

Refer to page 63-1 of the programming manual for details.

A-2-38-16 FTP Trans File

File name: FTP trans file

File No.: 913 Max. allocatable records: 99

0	20	22	24	44
Title	Program	File-No.	File name	

Refer to page 63-1 of the programming manual for details.

A-3. Counter and Totalizer calculation method	R-194
A-3-1 Fixed totalizer file	R-194

Calculation method

A-3. Counter and Totalizer calculation method

The following calculation methods of fixed totalizer memories are explained in this chapter.

All formulas in these explanations are calculated in the registration mode.

In the REF mode, the values in totalizers are calculated using the opposite sign.

In the REG- mode, the value in totalizers and counters are calculated using the opposite sign.

A-3-1 Fixed totalizer file

Total or counter	Increments or Decrements by
Gross sales quantity	Number of products registered for Departments + Subdepartments + PLUs (non hash) {For Department, Subdepartment and PLUs Single items : +1 Multiplication : Input quantity Split price : Input quantity Square : Input quantity × Input quantity Cube : Input quantity × Input quantity × Input quantity } – Last item void – Return item – Previous item void – Cancel
Gross sales amount	Amount of products registered for Departments + Subdepartments + PLUs (non hash) {For Department, Subdepartment and PLUs Single items : Preset or manually input prices Multiplication : Preset or manually input prices × Input quantity Split price : (Preset or manually input prices / Input unit quantity) × Input quantity Square : Preset or manually input prices × Input quantity × Input quantity Cube : Preset or manually input prices × Input quantity × Input quantity × Input quantity } – Last item void – Return item – Previous item void – Cancel
Net sales quantity	+1 (When a transaction is finalized for sale. For REG- mode –1 is affected.)
Net sales amount	Amount at the finalization (exclude tip): {Department + Subdepartment + PLU product registration amounts (non full hash) – Last item void amounts for the above – Item return amounts for the above – Previous item void amounts for the above – Cancel amounts for the above } + {Plus (+ key) + Premium (%+ key) – Error correction amounts – Cancel amounts } – {Minus (– key) + Discount(%– key) + Coupon – Error correction amounts – Cancel amounts } + Results of tax table calculations (add-on tax)
Medium in drawer (Cash, charge, check, credit)	Sales total or tendered total by specified medium + Received on account total (Cash in drawer only) – Paid out (Cash in drawer only) + Check cashing (Check in drawer only) + Loan totals by selected medium – Pick up totals by selected medium – Change amounts generated with the specific medium (Cash in drawer only) – Total of check cashing transaction (Cash in drawer only) – corrected amount by <MEDIA CHANGE> key + correcting amount by <MEDIA CHANGE> key

Total or counter	Increments or Decrements by
Number of REF mode	+1 (When cash sales, charge sales, credit sales, and check sales transaction are finalized in the REF/REG- mode.)
Refund mode amount	Absolute value of total sales amount for REF/REG- mode registrations.
Customer count	Entered number of covers or +1
Average sales per customer	Net sales amount / Customer count
Check cashing service fee	+ Check amount × Service ratio or + Service fee amount
New balance fee	+ MD/ST amount × Service charge ratio or + Service charge fee amount
Clerk commission total	Item sales (commissionable) × Clerk commission rate
Foreign currency in drawer	Entered amount in foreign currency.
Reduction	+ Registered amount of Minus, %- key
Item return amount	+ Registered item amount by RF, Void key
Clear count	+ 1 (REG, REF, REG- mode) (When the <CLEAR> key is pressed.)
Rounding	+ Fraction amount by roundings (Roundings include IF1/2, Denmark, Norway, Singapore, Finland, Australia and New Zealand.)
ST transfer void	+ Void total of ST transfer
Taxable amount	Subtotal of taxable amount at finalization of sale (in case of add-on tax) Subtotal of taxable amount / (1 + VAT rate) at finalization of sale (in case of add-in tax)
Tax amount	Result of calculation using tax table for taxable amount at finalization of sales (in case of add-on tax) Subtotal of taxable amount - Taxable amount calculated above Grand total of net sales totals
Tax exempt	Exempted taxable subtotal amount
Euro in drawer	Sales total or tendered total by specified medium in Euro
Coupon	Coupon total
Money declaration	+1 (when money declaration is performed.)
GT 1	Grand total of net sales total
GT 2	Registrations absolute value: {Registration amount (Department, Subdepartment, PLU) + Last item void amount + Previous item void amount + Refund amount} + {Plus, Minus, Premium, Discount, Coupon + Last item void amount}
GT 3	Net sales total – add-on tax – add-in tax – commission

Calculation method

A-5. Error messages	R-198
A-5-1 Error messages	R-198
A-5-2 Operation prompt	R-201
A-5-3 System error code	R-202

Error messages

A-4. Error messages

A-4-1 Error messages

When an error occurs on a QT-6100 terminal, a buzzer and the appropriate error message appears on the main display, indicating what action to take.

The following table lists the error messages and describes the action to take.

Prompt message	Meaning	Action
Operator mistake.	Operation error	Perform proper operation.
E001 Wrong mode.	Check tracking (Open mode error)	Return the mode to its original setting.
E003 Wrong operator.	Error clerk/Error clerk in check tracking	Input correct check number or assign the proper clerk.
E005 Insufficient memory.	Memory allocation over	Reallocate memory.
E011 Close the drawer.	Drawer compulsory	Close cash drawer.
E012 Journal paper end.	Journal paper end	Replace journal paper.
E014 Receipt paper end.	Receipt paper end	Replace receipt paper.
E015 Check R/J printer.	Internal R/J printer error	Check the internal R/J printer.
E016 Change back to REG mode.	Prohibit plural operation in REF/REG- mode	Switch to another mode and then back to the REF/REG- mode again.
E017 Enter Check/TBL number.	Check number compulsory	Input a check number.
E018 Enter Table number.	Table number compulsory	Input a table number.
E019 Enter Number of covers.	Cover compulsory	Enter the number of customers.
E020 Enter Seat number.	Seat number compulsory	Input a seat number.
E023 Stock running short.	Alarm when any item drops below its programmed minimum stock quantity during registration.	Perform stock maintenance.
E024 No stock is available.	Error when actual stock value for a registration items is a negative value.	Perform stock maintenance.
E028 Not found PLU or C/D is mismatch.	Scanning PLU is not found or OBR code is mismatched.	Re-enter the PLU code.
E029 No registration is possible while you are in the tender operation.	Attempted registration whilst partial tender operation is being done.	Finalize the transaction.
E031 Press ST key before Finalization.	ST compulsory	Press ST key.
E033 Enter tendered amount.	Amount tender compulsory	Enter tendered amount.
E035 Change amount exceeds the limit.	Change amount exceeds the limit.	Enter amount tendered again.
E036 Remove money from the drawer.	Contents of the drawer exceed the programmed limit — Sentinel function.	Perform pickup operation.
E037 Digit or Amount Limitation Over.	H.D.L., H.A.L., L.D.L. error	Enter correct unit price/amount.
E038 Perform Money Declaration	Money declaration compulsory	Perform money declaration.
E040 Issue Guest Receipt.	Guest receipt compulsory	Issue a guest receipt.
E041 Print Validation.	Validation compulsory	Perform validation operation.
E044 Print Cheque.	Check print compulsory	Perform check print operation.
E045 Print Check-Endorsement.	Check endorsement compulsory	Perform check endorsement operation.
E046 REG Buffer Full. Please Finalize or NB.	Registration buffer full	Finalize the transaction. Allocate sufficient buffer.
E047 Print bill.	Slip compulsory	Perform slip printing operation.
E048 Insert Slip Paper and retry.	Alarm when no paper is inserted in the Slip.	Insert new slip paper.
E049 CHECK memory full.	Check tracking index full/near end	Finalize and close the check number currently used.
E050 Detail memory full.	Check tracking memory full/near end	Finalize and close the check number currently used.
E051 CHK/TBL No. is occupied.	Attempt is made to use the <NEW CHECK> key to open a new check using a number that is already used for an existing check tracking memory.	Finalize and close the check that is currently under the number that you want to use or use a different check number.
E052 CHK/TBL No. is Busy.	Attempt to use the same check number whilst the specified number is being used in the other terminal.	Use another check number or close the check at that terminal.
E053 CHK/TBL No. is not opened.	Check number not found	Use the correct check number (if you want to reopen a check that already exists in the check tracking memory) or use <NEW CHECK> to open a new check.
E054 Out of CHK/TBL No. Range.	Check number range over	Enter correct number.
E056 Store range full.	All check number are occupied in range.	Recall the stored data.
E057 No item exists in detail.	Round repeat cannot be found in detail.	
E058 Enter post entry item.	Post entry item exists in detail.	Enter Post entry item.
E059 Press Eat-in or Take-out key.	Press eat-in or take-out key.	Press Eat-in or Takeout key.
***** E060 Printer offline. *****	Printer offline. "*****" means ECR logical ID and printer number.	
***** E061 Printer error.	Printer downed. "*****" means ECR logical ID and printer number.	The contents are printed on the backup printer.

Prompt message	Meaning	Action
***** E061 Printer error. YES:Retry to print. NO :Backup to R/J printer. ESC:Discard data.	Printer downed. "*****" means ECR logical ID and printer number.	Follow the prompt message.
***** E062 Printer paper end.	Paper near-end/end "*****" means ECR logical ID and printer number.	The contents are printed on the backup printer.
***** E062 Printer paper end. YES:Retry to print. NO :Backup to R/J printer. ESC:Discard data.	Paper near-end/end "*****" means ECR logical ID and printer number.	Follow the prompt message.
E064 Printer buffer full. YES:Retry to print. NO :Backup to R/J printer. ESC:Discard data.	Print buffer full at sender side	Follow the prompt message.
***** E070 Terminal out of action. Cannot print.	Down at target ECR which has printer "*****" means ECR logical ID and printer number.	
***** E071 Target terminal printer BF full. YES:Retry to print. NO :Backup to R/J printer. ESC:Discard data.	Printer buffer full at target ECR which has printer "*****" means ECR logical ID and printer number.	Follow the prompt message.
***** E072 Target printer terminal is busy.	Busy at target ECR which has printer "*****" means ECR logical ID and printer number.	
***** E073 Your receipt/order may not be issued. YES:Retry to print. NO :Backup to R/J printer. ESC:Discard data.	Time out at ECR which has printer "*****" means ECR logical ID and printer number.	Follow the prompt message.
E075 Negative Balance, cannot be finalized.	Attempted finalization when balance is less than zero.	Register item(s) until the balance becomes positive amount.
E080 Electronic Journal Full Please clear E-Journal.	Electronic journal full	Reset the electronic journal memory.
E082 ***** Illegal Data *****	Illegal Electronic journal data	
E083 Cannot create E-Journal. Check Flash memory.	Electronic journal file cannot be created.	Check flash memory.
***** E105 Check/TBL tracking Master down. Please call Manager!! YES:Retry for connection. NO :Remove it from system.	CHK master down "*****" means ECR logical ID.	Follow the prompt message.
***** E106 Check/TBL tracking Backup master down. Please call Manager!! YES:Retry for connection. NO :Remove it from system.	CHK BM down "*****" means ECR logical ID.	Follow the prompt message.
***** E107 Both Master&Backup master down. CHK/TBL tracking or Clerk interrupt is not available.	CHK M/BM down "*****" means ECR logical ID.	
***** E108 CHK/TBL Master is removed from system.	Master down then take it off from system "*****" means ECR logical ID.	
***** E109 CHK/TBL Backup master is removed from system.	Backup master down then take it off from system "*****" means ECR logical ID.	
E110 CHK data mismatch between Master and Backup master.	Data mismatch has occurred.	
E130 Middle of Pick up or Loan Press Cancel Key.	During picking up	Follow the prompt message.
E131 Middle of <Bill Copy> Press Cancel Key.	During bill copy	Follow the prompt message.
E133 Middle of <Media Change> Press Cancel Key.	During media change	Follow the prompt message.

Error messages

Prompt message	Meaning	Action
E134 Middle of Clerk Transfer Press ESC Key.	During clerk transfer	Follow the prompt message.
E136 Middle of Separate Check Press ESC key.	During separate check	Follow the prompt message.
E139 Not allowed to be negative by Minus/Coupon key.	Credit balance error	Enter proper minus/coupon amount.
E140 Wrong menu.	This sheet holder is prohibited by program.	Set correct sheet holder.
E141 Press <TRAY TTL> twice before finalization.	<TRAY TOTAL> key is not pressed twice before finalization.	Follow the prompt message.
E145 Arrangement syntax error.	Arrangement syntax error	Program the arrangement again.
E150 Incorrect value entry.	Incorrect entry for PGM	Enter proper value again.
E151 Incorrect Key Pressed.	Linking is incorrect.	Enter proper key again.
E152 PGM File or Memory number does not Exist.	No such file, no such record	Enter file/record number again.
E164 Employee No. is not Found in the Employee File.	Employee No. is not set in the Employee File.	Enter employee number again.
E165 Employee No. is not Clocking-in.	Employee has not done CLOCK-IN operation yet.	Perform CLOCK-IN operation.
E166 Employee No. is Occupied.	Employee who has done CLOCK-IN operation attempts to operate CLOCK-IN again.	Enter the proper employee number again.
E167 Incorrect Job code.	Employee attempts to operate CLOCK-IN with incorrect JOB code.	Enter proper job code.
E168 Your Operation is out of Schedule. Please Call Manager.	Employees operate CLOCK-IN/OUT in not allowance time.	Follow the prompt message.
E169 Work Hours Exceeded. Please Call Manager.	Overtime work.	Follow the prompt message.
E170 No Shift Remains in the Schedule. You cannot Clock-in.	There is no available shift left.	
E171 Please Break-out and Retry.	Employee attempts to operate CLOCK-OUT whilst he/she is in a break time.	Follow the prompt message.
E172 Break Hours Exceeded. Please Call Manager.	Break hours are exceeded.	Follow the prompt message.
E173 This employee is at work now.	Employee is at work without break.	
E174 This employee is taking a break now.	Employee who has not done BREAK-OUT operation attempts to operate BREAK-IN.	
E175 Please Clock-in/Break-out before you sign on. or Please Call Manager.	Sign on after you clock-in or break out.	Follow the prompt message.
E176 You cannot Clock-in. Please reset Employee Report.	Employee Report has not been reset.	Follow the prompt message.
E177 Time&Attendance Data Communication Error. Please Call Manager.	Time & Attendance Data communication error.	Follow the prompt message.
E180 IDC FILE (1) memory full. Please clear IDC data.	IDC FILE (1) memory is full of items.	Follow the prompt message.
E181 IDC FILE (2) memory full. Please clear IDC data.	IDC FILE (2) memory is full of items.	Follow the prompt message.
E182 IDC FILE (3) memory full. Please clear IDC data.	IDC FILE (3) memory is full of items.	Follow the prompt message.
E200 Insert CF Card.	CF card is not inserted to the slot.	Insert CF card.
E201 Format error.	CF card data or formats illegal.	Check the CF card.
E203 Insufficient memory.	Insufficient memory is remained in CF card.	Format or use a new CF card.
E205 The file already exists. Do you replace? YES:Replace the file. NO :Input new name.	File name duplication error	Follow the prompt message.
E240 Customer No. is occupied.	Attempt is made to set a customer that already exists in the customer file.	Enter proper customer No.
E241 Customer memory full.	Customer file becomes full.	Delete unnecessary customer No.
E242 Customer not found.	This customer does not exist.	Enter proper customer No.
E243 Illegal Site ID.	The site No. of the file does not coincide with the No. of the card.	Swipe the proper magnetic card.
E244 Credit limit over.	Attempt to transfer when the balance is over than the credit limit	Release credit limit by OPEN2 Make minus, void, or refund operation to decrease the balance under the credit limit. Perform finalization or cancellation.
E251 Magnetic card error.	This card cannot be read. This card format is illegal.	Swipe the magnetic card again. Swipe the proper magnetic card.
E252 Enter customer name.		Follow the prompt message.
E253 Enter address.		Follow the prompt message.
E254 Enter phone number.		Follow the prompt message.

A-4-2 Operation prompt

All prompt messages, together with descriptors and symbol characters for displaying / printing are contained in the list below. These messages cannot be added, modified or deleted.

Prompt message	Meaning
Data cannot be printed out. Backup to R/J printer?	Request to check the X / Z report data which cannot be printed out.
Do you want to clear data?	Confirmation to reset displayed report.
Cancel OK?	Confirmation of all void operation.
Please wait.	Please wait. ECR now processing.
Item Consolidation Mode	In the item consolidation mode.
Non Consolidation Mode	Not in the item consolidation mode.
REG Mode	Mode change : REG mode
REFUND Mode	Mode change : REF mode
REG- Mode	Mode change : REG- mode
Training	Signing on a training operator
REG2 Mode	Mode change : REG2 mode
Please Sign on.	The terminal is in signed off.
Enter Check/Table Number.	CHK# compulsory
Enter Table Number.	TBL# compulsory
Enter Number of covers.	Covers compulsory
Enter Seat Number.	Seat# compulsory
Perform Slip Printing.	Slip compulsory
Issue Guest Receipt.	GUEST RCT compulsory
Perform Validation Printing.	VLD compulsory
Perform Check Printing.	CHK-PRT compulsory
Perform Check Endorsement.	CHK-END compulsory
Operation Code?	Enter secret number for REG 2 mode.
Re_configuration...	During system reconfiguration
Re_configuration end	System reconfiguration ends
Clock-in OK?	Time and attendance clock-in operation
Clock-out OK?	Time and attendance clock-out operation
Break-in OK?	Time and attendance break-in operation
Break-out OK?	Time and attendance break-out operation
Enter cash tip amount and press <YES> key.	Time and attendance tip declaration compulsory
Communication Error	Communication error during clock-in
This procedure stops system maximum 60 sec. OK ?	Alert before flash memory clear.
Enter #	Registering Non-add after RC / PD.
Enter Alphacode!	To search the appropriate item, enter goods name.
Items not found!	Items cannot be found by item searching.

Error messages

A-4-3 System error code

All error codes are contained in the list below. These error codes are displayed or printed on error log report.

Error code	Meaning
0010	Handler access error (software)
0011	Cannot execute handler (system configuration)
0012	Break by PC
0013	Break by ECR
0014	DSR off before receiving command packet
0015	Receive illegal command number of command packet
0016	Receive illegal character
0017	Send error (hardware)
0018	Receive error (hardware)
0019	Receive illegal data packet
0020	No response error
0021	Receive illegal command phase
0022	Received illegal packet
0023	CNET receive error
0024	Illegal termination by sender
0025	Received illegal packet during receiving data packets
0026	Not enough data packets received
0040	No "H" information
0041	No "I" information
0042	No "F" information
0044	Illegal packet format
0045	No file exists
0046	Illegal block
0047	Illegal command packet
0048	Illegal command No. (Not CMD)
0049	Illegal command No. (Not DATA)
0050	Sequence error
0051	Turn off DSR signal
0052	Received cancellation
0053	Retry over while waiting command
0054	Retry over while waiting EOT
0055	Retry over while waiting data
0056	Received EOT
0057	Retry over while waiting ACK
0058	Retry over while sending data
0059	Retry over while waiting "C"
0060	Retry over while sending response
0061	Retry over while excluding
0064	Break end
0065	Error during printing report header
0066	Error during printing report data
0067	Error during printing report data in work file
0068	Error during printing report data in consolidation file
0069	Work file clear error
0070	Consolidation file clear error
0071	Z lock error
0072	Z clear error
0073	Z lock release error
0074	Error during accumulating to consolidation file
0075	Error during copying report data from terminal memory to work
0076	Error during copying stock data to terminal memory
0077	Z lock error on satellite terminal
0078	No appropriate file is exist on satellite terminal during collection/consolidation
0079	Z lock release error on satellite terminal
0081	Check tracking master is removed from system.

Error code	Meaning
0082	Check tracking backup master is removed from system.
0128	Parameter error / Maximum length of send error
0130	Error drive
0134	Network parameter error
0138	Detect error in core system
0140	Parameter error (record length exceeds work buffer)
0141	EOF over
0144	Calculation overflow
0145	Undefined value of n_open () mode
0146	Mismatch of type when closing network
0147	Parameter error
0152	Defined NCB is not network resource
0153	Retry over by the target busy
0155	Sequence error
0156	No port exists
0158	Target port in use
0160	Error while getting priority
0161	Fail to change temporary priority
0162	Error semaphore operation to keep resource
0163	Fail to get new sled
0164	Error while getting semaphore
0165	Error to operate semaphore
0166	Error during delay
0167	Error during termination
0168	Error when resource return
0170	Error during getting task ID
0171	No code is found while search/pick up
0172	Cannot get work buffer
0173	File opened/fail to activate task
0174	No file exists
0175	ITRON service error
0176	Cannot create file
0177	Record number error
0178	Detect error while memory area opening
0179	Detect error while returning mail box / double create error
0180	Detect error while handling memory
0190	RCB is not mail box resource
0192	Error send message ID
0194	Send message length over
0197	Ending response
0198	Time out while waiting for ending response / no receive message
0202	No free FCB
0204	Memory capacity shortage
0205	Fail to create mail box
0209	Cannot find the coincide PCB resource
0210	Cannot find the coincide RCB resource
0232	ID collision when network starts
0233	Cannot find the target ID
0235	Protocol error
0247	Stop token
0248	FTP client can't open data connection.
0249	FTP client requested file action not taken.
0250	FTP client local error in processing
0251	FTP client syntax error

Error messages

Index

A

add check R-35, R-160, P-21
add mode P-31
alphabet key P-104
amount symbol P-112
arrangement R-32, R-50, R-160, R-186, P-16, P-21, P-29, P-68, P-129
arrangement control P-74
arrow key R-29
Australian GST control P-59
auto program control R-190, P-14, P-57, P-156

B

backspace key P-105
backup master R-17
barcode R-135
batch X/Z R-185, P-17, P-29, P-129
bill copy R-33, R-160, P-21
Bon P-81
break-in / out R-36, R-64, R-160, P-21
brightness control R-14

C

Canadian tax P-31
cancel R-37, R-124, R-160, P-21
card slot cover R-10
cash amount tendered R-30, R-160, P-21
cash drawer R-14
CF X/Z conversion table P-158
character conversion for CF R-187, P-17
character conversion table P-62
character key R-25
character key table P-14
character programming keyboard P-104
character recall R-186, P-17
character search P-28
charge R-30, R-160, P-21
check detail P-16
check endorsement R-32, R-160, R-185, P-21
check index P-16
check print R-28, R-30, R-160, R-186, P-17, P-21, P-43, P-149
check tender R-30, R-160, P-21
check tracking R-17, R-43, P-40
check window P-60, P-156
check# pop-up window definition R-188
check# popup window definition P-17
circular key P-22
clear key R-29, R-160
clerk R-12, R-146, R-170, P-16
clerk control P-64, P-70
clerk detail R-48, R-171, P-75, P-171
clerk detail link R-171
clerk feature P-159
clerk interrupt R-17, R-47, P-40
clerk key ID R-171, P-76, P-171
clerk number R-34, R-160, P-21
clerk pop-up window definition R-188, P-17
clerk totalizer R-24

clerk training R-48
clerk transfer R-30, R-160, P-21
clerk window P-76, P-171
clock-in R-60
clock-in / out R-35, R-160, P-21
clock-out R-63
collection/consolidation system R-19
COM port R-15, R-16
commission rate P-69, P-75, P-81, P-159
communication control P-37
condiment P-39, P-78
connector R-15
connector cover R-10
consecutive number R-12, P-14
consolidation file R-23
consolidation work file R-23
coupon R-31, R-160, P-21
coupon2 R-32, R-160, P-21
covers P-21
credit R-30, R-160, P-21
cube R-35, R-160, P-21
currency exchange R-33, R-160, P-21
customer R-138, R-157, R-181, P-16
customer control P-61
customer count P-112
customer group R-156, R-181, P-16, P-61, P-157
customer ID number R-37, R-160, P-21
customer title R-181, P-16, P-114, P-127

D

decimal point R-160
declaration R-160, P-21
delete key P-104
department R-33, R-151, R-160, R-168, P-14, P-21, P-108, P-119, P-120, P-125, P-126, P-172
department feature P-80
department link P-81
department number R-37, R-160, P-21
department totalizer R-24
deposit R-31, R-160, P-21
discount R-31, R-160, P-21
display R-13
display area color definition P-14
display buffer P-17
display control P-41
display mode R-37, R-160, P-21
display on/off key R-10, R-29
double key P-22
double size letter key P-104
down arrow R-160
drawer R-15
Dutch account R-37, R-132, R-160, P-21

E

eat-in R-36, R-134, R-160, P-21
EBT tender R-30, R-160, P-21
electronic journal R-37, R-78, R-154, P-17
electronic journal display R-160, P-21
employee R-57, R-154, R-177, P-16, P-54, P-151
endorsement R-28, P-17, P-113, P-127

enter key P-105
error correct R-32, R-160, P-21
error message R-198
ESC/SKIP key R-29, R-160, P-105
Euro R-31, R-187, P-17, P-56, P-155

F

file concept R-23
finalize key R-30
first unit price R-34, R-160, P-21
fixed totalizer R-24, R-147, R-164, R-194, P-14, P-35, P-111, P-127
flag clear P-10
flash R-146
flat PLU R-34, R-160, P-21
food stamp status shift R-33, R-160, P-21
food stamp subtotal R-35, R-160, P-21
food stamp system P-31
food stamp tender R-30, R-160, P-21
foreign currency P-112
free function R-147
ftp R-20, R-53, R-99-1, R-192, P-14, P-30, P-63, P-63-1, P-158
full hash item P-81
function control P-66, P-67, P-68, P-71, P-72, P-73
function key R-25, P-108, P-120, P-125, P-126, P-176
function key totalizer R-24

G

general control R-182, P-17
grace time R-57
grand total R-180, P-15
graphic logo R-55, R-186, P-17
group R-152, R-169, P-15, P-111, P-127
group link P-81
group totalizer R-24
GT P-114, P-127
guest receipt message P-110

H

hand-held scanner R-16
hard key code R-12
hardware configuration R-10
hash item P-81
high amount limit P-81
home position key R-29, R-160
hourly / labor R-176
hourly item R-56, R-156, R-173, P-16
hourly item link R-173, P-55, P-154
hourly labor R-156, P-16
hourly sales R-153, R-172, P-15, P-37
house Bon R-36, R-160, P-21

I

i-Button key receiver R-10
I/O parameter R-190, P-14, P-48, P-150
IDC R-67, R-72, R-156, R-175, P-17
IDC link R-175, P-56, P-154
individual key R-146

INIT2 P-10
initialization P-8
inline R-15, P-48
inner multiplication R-129
insert key P-104
intelligent electronic journal R-78, P-17
item descriptors by range P-108
item search R-37, R-139, R-160, P-21
item type P-81

J

job code R-57, R-177, P-16, P-53, P-152
journal control P-38

K

Ketten Bon R-36, R-160, P-21
key allocation P-20
key table R-189
keyboard R-12, P-176
keyboard bitmap image R-191, P-17
keyboard color definition R-191, P-14, P-63, P-158
keyboard color theme R-191, P-14, P-62, P-158

L

LCD color control R-190, P-58, P-156
left arrow key R-160
left cursor key P-104
linkage of totalizers R-24
list R-37, R-126, R-160, P-21, P-28
list link P-78, P-79, P-81
list number R-37, R-160, P-21
loan R-31, R-160, P-21
local printer R-17
location change R-37, R-160, P-21
lock out unused key P-21
low digit limit P-81

M

magnetic card reader P-50
master R-17
media change R-36, R-133, R-160, P-21
memory allocation P-12, P-176
menu level character P-17
menu level display R-14
menu shift R-34, R-160, P-21, P-41
menu shift / 2nd@ P-65, P-70
menu title P-114, P-127
merchandise subtotal R-34, R-160, P-21
message control P-39
minimum stock P-78, P-81
minus R-31, R-160, P-21
mode R-12, R-26
mode control R-48, P-65, P-71
mode key R-29, R-160, P-21
money declaration P-32, P-33
monthly sales R-153, R-172, P-15
multiple validation P-81
multiplication R-160, P-21, P-112

Index

N

negative price P-81
new / old check R-35, R-160, P-21
new balance R-30, R-160, P-21
new check R-35, R-160, P-21
no key R-29, R-160
no sale R-32, R-160, P-21
non-add R-32, R-160, P-21
non-add / no sale R-32, R-160, P-21
normal receipt R-31, R-160, P-21
number of customer R-32, R-160, P-21
numeric key R-29, R-160

O

OBR R-35, R-160, P-21
old check R-35, R-160, P-21
online P-48
open R-34, R-160, P-21
open check R-36, R-132, R-154, R-160, P-21
open PLU P-81
open2 R-34, R-160, P-21
operation prompt R-201
operator number R-34, R-160, P-21
operator read / reset R-34, R-160, P-21
order character R-187, P-17, P-81, P-126
order character change R-37, R-139, R-160, P-21
order character link P-110
order color P-81
order control P-39
order of date P-31
order print P-78, P-79, P-81

P

page down key R-29, R-160
page up key R-29, R-160
paid out R-31, R-160, P-21
panel fixing screw R-10
payment R-37, R-160, P-21
physical key table P-14
pick up R-31, R-160, P-21
PLU R-33, R-147, R-160, R-166, P-14, P-21, P-107, P-118, P-120, P-125, P-126, P-172
PLU 2nd@ R-166, P-17, P-107, P-118, P-120, P-125, P-126, P-172
PLU 2nd@ feature P-79
PLU feature P-78
PLU totalizer R-24
plus R-32, R-160, P-21
post entry R-36, R-130, R-160, P-21
power switch R-15
power switch cover R-10
premium R-32, R-160, P-21
preparation P-78
presetting date P-118
presetting time P-118
price R-33, R-160, P-21
price inquiry R-30, R-160, P-21
print buffer P-17
print control P-34

printer connection table R-190, P-14, P-51, P-150
pulldown group R-127, R-184, P-17, P-28, P-109, P-121, P-128

Q

QT-6060D R-16
quadruple key P-22
quantity / for R-35, R-160, P-21

R

random code P-36
random PLU P-32
recall R-37, R-45, R-160, P-21
receipt R-26, R-32, R-160, P-21
receipt / slip message R-185, P-17
receipt message P-110, P-126
receipt on / off R-34, R-160, P-21
receipt type P-81
received on account R-31, R-160, P-21
rectangular key P-22
refund R-32, R-142, R-160, P-21
register minus R-142
registration buffer P-17
remote display R-16, P-49
remote printer R-16, R-17, R-38, P-49
report control P-35, P-36
report header R-183, P-17, P-113, P-127
right arrow key R-160
right cursor key P-104
round repeat R-36, R-136, R-137, R-160, P-21
rounding P-31, P-32, P-33, P-35, P-44, P-53, P-56, P-83, P-90, P-93, P-96, P-111

S

satellite R-17
scanner P-50
scanning PLU R-134
scanning PLU link P-17, P-176
schedule R-57, R-178, P-16, P-54, P-152
scheduler R-187, P-17, P-42, P-149
scroll area R-12
seat number R-36, R-160, P-21
second unit price R-34, R-160, P-21
selective item P-81
selective item subtotal R-35, R-160, P-21
self master R-17
separate check R-35, R-131, R-160, P-21
set menu R-127, R-184, P-17, P-29, P-39, P-78, P-81, P-129
shared check tracking R-43
shift key P-104
shift PLU R-34, R-135, R-147, R-160, R-167, P-15, P-21, P-121
sign on R-65
sign on / off R-122
Singaporean tax P-31
single item P-78, P-79
slip R-28
slip back feed / release R-33, R-160, P-21

slip control P-38
slip feed / release R-33, R-160, P-21
slip message P-110
slip print R-33, R-160, P-21
slip printer R-16, P-50
SP-1300 R-16
space key P-104
special character R-183, P-17, P-112, P-127
split pricing P-112
square R-35, R-160, P-21
stand R-10
status icons R-12
stock R-150
stock inquiry R-30, R-160, P-21
store R-36, R-45, R-160, P-21
subdepartment R-37, R-150, R-160, R-165, P-14, P-21, P-107, P-119, P-120, P-125, P-126, P-172
subdepartment feature P-79
subdepartment link P-81
subdepartment number R-37, R-160, P-21
subdepartment totalizer R-24
substitution R-36, R-128, R-160, P-21
subtotal R-34, R-160, P-21
suspend R-130
system configuration R-17
system connection R-189, P-14, P-47, P-150
system error code R-202
system error log R-190, P-14
system key R-25, R-29

T

table analysis R-153, R-179, P-15, P-44, P-149
table number R-33, R-160, P-21
table range P-69, P-75, P-159
table sharing R-37, R-139, R-160, P-21
table transfer R-31, R-45, R-160, P-21
takeout R-36, R-134, R-160, P-21
tax exempt R-34, R-160, P-21
tax status shift R-33, R-160, P-21
tax system P-31
tax table R-183, P-17, P-44, P-150
taxable amount subtotal R-34, R-160, P-21
taxable status P-78, P-81
taxable symbol P-112
TCP/IP R-192, P-14, P-63, P-158
terminal file R-23
text print R-30, R-160, P-21
text recall R-30, R-160, P-21, P-110, P-126
three zero R-160
time & attendance R-57, P-16, P-53
time zone R-177, P-16, P-52, P-151
tip R-31, R-160, P-21
touch screen key table R-189, P-14
touch screen panel R-10
transaction key R-165, P-14
tray total R-34, R-160, P-21
two zero R-160

U

U.S. tax P-31
unit stock P-78, P-81
up arrow R-160
UP-360 R-16, R-39

V

validation R-27, R-32, R-160, P-21
VAT R-33, R-160, P-21, P-31, P-36
VAT & VAT P-46
void R-32, R-123, R-160, P-21
void reason R-153, P-15
void table R-179, P-47, P-150

W

work time R-176, P-16

X

X/Z report R-28
X/Z report control P-74

Y

yes key R-29, R-160

Z

zero unit price P-81

CASIO®

CASIO COMPUTER CO., LTD.

6-2, Hon-machi 1-chome
Shibuya-ku, Tokyo 151-8543, Japan

Ⓝ MA0806-A
QT-6100REF*E

Free Manuals Download Website

<http://myh66.com>

<http://usermanuals.us>

<http://www.somanuals.com>

<http://www.4manuals.cc>

<http://www.manual-lib.com>

<http://www.404manual.com>

<http://www.luxmanual.com>

<http://aubethermostatmanual.com>

Golf course search by state

<http://golfingnear.com>

Email search by domain

<http://emailbydomain.com>

Auto manuals search

<http://auto.somanuals.com>

TV manuals search

<http://tv.somanuals.com>