

brother®

ADVANCED USER'S GUIDE

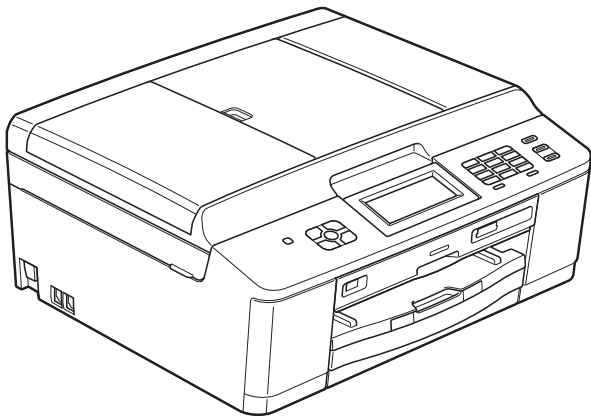

MFC-J825DW
MFC-J835DW

Version A

USA/CAN

User's Guides and where do I find it?

Which manual?	What's in it?	Where is it?
Product Safety Guide	Read this Guide first. Please read the Safety Instructions before you set up your machine. See this Guide for trademarks and legal limitations.	Printed / In the box
Quick Setup Guide	Follow the instructions for setting up your machine and installing the drivers and software for the operating system and connection type you are using.	Printed / In the box
Basic User's Guide	Learn the basic Fax, Copy, Scan and PhotoCapture Center™ operations and how to replace consumables. See troubleshooting tips.	Printed / In the box
Advanced User's Guide	Learn more advanced operations: Fax, Copy, security features, printing reports and performing routine maintenance.	PDF file / CD-ROM
Software User's Guide	Follow these instructions for Printing, Scanning, Network Scanning, PhotoCapture Center™, Remote Setup, PC-Fax, Disc Print, Web Services (Scan), and using the Brother ControlCenter utility.	PDF file / CD-ROM
Network Glossary	This Guide provides basic information about advanced network features of Brother machines along with explanations about general networking and common terms.	PDF file / CD-ROM
Network User's Guide	This Guide provides useful information about wired and wireless network settings and security settings using the Brother machine. You can also find supported protocol information for your machine and detailed troubleshooting tips.	PDF file / CD-ROM
Mobile Print/Scan Guide	This Guide provides useful information about printing data from your mobile phone and transmitting scanned data from the Brother machine to your mobile phone.	PDF file / Brother Solutions Center ¹
Web Connect Guide	This Guide provides useful information about accessing internet services from the Brother machine, as well as downloading images, printing data and uploading files directly from internet services.	PDF file / Brother Solutions Center ¹

¹ Visit us at <http://solutions.brother.com/>.

Table of Contents

1	General setup	1
	IMPORTANT NOTE.....	1
	Memory storage.....	1
	Volume Settings.....	1
	Ring Volume.....	1
	Beeper Volume.....	2
	Speaker Volume.....	2
	Automatic Daylight Saving Time.....	3
	Sleep Mode.....	3
	LCD screen.....	4
	Setting the backlight brightness.....	4
	Setting the Dim Timer for the backlight.....	4
	Mode Timer.....	4
2	Security features	5
	Memory Security.....	5
	Setting and changing the Memory Security password.....	5
	Turning Memory Security on/off.....	6
3	Sending a fax	7
	Additional sending options.....	7
	Sending faxes using multiple settings.....	7
	Stop faxing.....	7
	Contrast.....	7
	Changing fax resolution.....	8
	Setting your changes as the new default.....	8
	Restoring fax settings to the factory settings.....	8
	Additional sending operations.....	9
	Sending a fax manually.....	9
	Sending a fax at the end of a conversation.....	9
	Dual Access (Black & White only).....	9
	Broadcasting (Black & White only).....	10
	Real Time Transmission.....	11
	Overseas Mode.....	12
	Delayed Faxing (Black & White only).....	12
	Delayed Batch Transmission (Black & White only).....	13
	Checking and canceling waiting jobs.....	13
	Polling overview.....	14
	Polled Transmit (Black & White only).....	14

4	Receiving a fax	15
	Memory Receive (Black & White only)	15
	Receiving faxes into memory when paper tray is empty	15
	Fax Forwarding.....	15
	Paging	16
	Fax Storage	17
	Printing a fax from the memory	17
	PC-Fax Receive (Windows® only).....	18
	Turning off Memory Receive operations.....	19
	Changing Memory Receive operations	19
	Remote Retrieval	20
	Setting a Remote Access Code.....	20
	Using your Remote Access Code.....	20
	Remote Fax commands	21
	Retrieving fax messages	22
	Changing your Fax Forwarding number	22
	Additional receiving operations.....	23
	Printing a reduced incoming fax	23
	Receiving a fax at the end of a conversation.....	23
	Polling overview.....	24
	Polling receive	24
5	Dialing and storing numbers	26
	Voice operations	26
	Tone or Pulse (Canada only).....	26
	Fax/Tel mode.....	26
	Caller ID.....	26
	Special line considerations	27
	Additional dialing operations.....	29
	Outgoing Call.....	29
	Caller ID history	29
	Dialing access codes and credit card numbers	30
	Additional ways to store numbers.....	31
	Storing Speed Dial numbers from Outgoing Calls.....	31
	Storing Speed Dial numbers from the Caller ID history	31
	Setting up groups for Broadcasting	32
6	Printing reports	34
	Fax reports.....	34
	Transmission Verification Report.....	34
	Fax Journal (activity report)	34
	Reports	35
	How to print a report	35

7 Making copies 36

Copy settings	36
Stop copying	36
Changing copy quality	36
Enlarging or reducing the copied image	37
Making N in 1 copies or a poster (Page Layout)	38
2 in 1 ID Copy	39
Sorting copies using the ADF	40
Adjusting Density	40
Ink Save Mode	41
Thin Paper Copy	41
Book Copy	42
Watermark Copy	42
Duplex (2-sided) copying	44
Setting your favorites	45

8 PhotoCapture Center™: Printing photos from a memory card or USB Flash memory drive 46

PhotoCapture Center™ operations	46
Memory cards, USB Flash memory drive and folder structures	46
Movie printing	47
Print Images.....	47
Print Index (Thumbnails)	47
Printing Photos	48
Enhance Photos	48
DPOF printing.....	50
PhotoCapture Center™ print settings.....	51
Print Quality	51
Paper options	51
Adjusting Brightness, Contrast and Color.....	52
Cropping	53
Borderless printing.....	54
Print Date.....	54
Setting your changes as the new default.....	54
Restoring all settings to the factory settings	54
Scan to a memory card or USB Flash memory drive	55
Auto Crop	55
How to set a new default	56
How to reset to the factory settings	56

9 Printing photos from a camera 57

Printing photos directly from a PictBridge camera.....	57
PictBridge requirements	57
Setting your digital camera	58
Printing Images.....	59
DPOF printing.....	59
Printing photos directly from a digital camera (without PictBridge).....	60
Printing Images.....	60

A	Routine maintenance	61
	Cleaning and checking the machine	61
	Cleaning the outside of the machine	61
	Cleaning the machine's printer platen	62
	Cleaning the paper feed rollers	63
	Cleaning the paper pick-up rollers	64
	Checking the ink volume	65
	Packing and shipping the machine	65
B	Glossary	68
C	Index	72

IMPORTANT NOTE

- In this manual, the LCD messages of the MFC-J825DW are used unless specified.
- Most of the illustrations in this User's Guide show the MFC-J825DW.

Memory storage

Your menu settings are stored permanently, and in the event of a power failure will not be lost. Temporary settings (for example, Overseas Mode) will be lost. If you have chosen `Set New Default` for your **FAX**, **SCAN** and **PHOTO** preferred settings, those settings will not be lost. Also, during a power failure the machine will retain the date and time and programed fax timer jobs (for example, Delayed Fax) for approximately 24 hours.

Volume Settings

Ring Volume

You can choose a range of ring volume levels, from `High` to `Off`. The machine will keep your new default setting until you change it.

Setting the Ring Volume from the menu

- 1 Press `Menu`.
- 2 Press `▲` or `▼` to display `General Setup`.
- 3 Press `General Setup`.
- 4 Press `▲` or `▼` to display `Volume`.
- 5 Press `Volume`.
- 6 Press `Ring`.
- 7 Press `Low`, `Med`, `High` or `Off`.
- 8 Press **Stop/Exit**.

Beeper Volume

When the beeper is on, the machine will beep when you press a key, make a mistake, or after you send or receive a fax.

You can choose a range of beeper volume levels, from *High* to *Off*.



- 1 Press **Menu**.
- 2 Press **▲** or **▼** to display *General Setup*.
- 3 Press *General Setup*.
- 4 Press **▲** or **▼** to display *Volume*.
- 5 Press *Volume*.
- 6 Press *Beeper*.
- 7 Press *Low*, *Med*, *High* or *Off*.
- 8 Press **Stop/Exit**.

Speaker Volume

You can choose a range of speaker volume levels, from *High* to *Off*.

- 1 Press **Menu**.
- 2 Press **▲** or **▼** to display *General Setup*.
- 3 Press *General Setup*.
- 4 Press **▲** or **▼** to display *Volume*.
- 5 Press *Volume*.
- 6 Press *Speaker*.
- 7 Press *Low*, *Med*, *High* or *Off*.
- 8 Press **Stop/Exit**.

You can also adjust the speaker volume by pressing **Hook**.

- 1 Press **Hook** on the control panel.
- 2 Press **◀** or **▶** on the Touchscreen to display the *Volume* button.
- 3 Press *Volume*.
- 4 Press  or  on the Touchscreen.
Each button press changes the volume to the next setting.
Press **OK**.
- 5 Press **Hook**.

Automatic Daylight Saving Time

You can set the machine to change automatically for daylight saving time. It will reset itself forward one hour in the Spring and backward one hour in the Fall. Make sure you have set the correct date and time in the `Date&Time` setting.

The factory setting is `Off`, so you will have to turn on Automatic Daylight Saving Time as follows.

- 1 Press `Menu`.
- 2 Press `▲` or `▼` to display `General Setup`.
- 3 Press `General Setup`.
- 4 Press `▲` or `▼` to display `Auto Daylight`.
- 5 Press `Auto Daylight`.
- 6 Press `On` (or `Off`).
- 7 Press **Stop/Exit**.

Sleep Mode

You can choose how long the machine must be idle (up to 60 minutes) before it goes into Sleep Mode. The timer will restart if any operation is carried out on the machine.

- 1 Press `Menu`.
- 2 Press `▲` or `▼` to display `General Setup`.
- 3 Press `General Setup`.
- 4 Press `▲` or `▼` to display `Sleep Mode`.
- 5 Press `Sleep Mode`.
- 6 Press `1 Min`, `2 Mins`, `3 Mins`, `5 Mins`, `10 Mins`, `30 Mins` or `60 Mins` to choose the length of time the machine is idle before entering sleep mode.
- 7 Press **Stop/Exit**.

LCD screen

Setting the backlight brightness

You can adjust the brightness of the LCD backlight. If you are having difficulty reading the LCD, try changing the brightness setting.

- 1 Press **Menu**.
- 2 Press **▲** or **▼** to display **General Setup**.
- 3 Press **General Setup**.
- 4 Press **▲** or **▼** to display **LCD Settings**.
- 5 Press **LCD Settings**.
- 6 Press **Backlight**.
- 7 Press **Light**, **Med** or **Dark**.
- 8 Press **Stop/Exit**.

Setting the Dim Timer for the backlight

You can set how long the LCD backlight stays on after you go back to the Ready screen.

- 1 Press **Menu**.
- 2 Press **▲** or **▼** to display **General Setup**.
- 3 Press **General Setup**.
- 4 Press **▲** or **▼** to display **LCD Settings**.
- 5 Press **LCD Settings**.
- 6 Press **Dim Timer**.
- 7 Press **10 Secs**, **20 Secs**, **30 Secs** or **Off**.
- 8 Press **Stop/Exit**.

Mode Timer

The machine has four temporary mode keys on the control panel: **FAX**, **SCAN**, **COPY** and **PHOTO**. You can change the amount of time the machine takes after the last Scan, Copy or PhotoCapture operation before it returns to FAX mode. If you choose **Off**, the machine stays in the mode you used last.



- 1 Press **Menu**.
- 2 Press **▲** or **▼** to display **General Setup**.
- 3 Press **General Setup**.
- 4 Press **▲** or **▼** to display **Mode Timer**.
- 5 Press **Mode Timer**.
- 6 Press **0 Sec**, **30 Secs**, **1 Min**, **2 Mins**, **5 Mins** or **Off**.
- 7 Press **Stop/Exit**.

Memory Security

Memory Security lets you prevent unauthorized access to the machine. You will not be able to continue to schedule Delayed Faxes or Polling jobs. However, any pre-scheduled Delayed Faxes will be sent even if you turn on Memory Security, so they will not be lost.

While Memory Security is On, the following operations are available:

- Receiving faxes into memory (limited by memory capacity)
- Fax Forwarding (if Fax Forwarding was already On)
- Paging (if Paging was already On)
- Remote Retrieval (if Fax Storage was already On)

While Memory Security is On, the following operations are NOT available:

- Printing received faxes
- Sending faxes
- Copying
- PC printing
- Scanning
- PhotoCapture
- PC Fax Receive
- Operation from control panel

Note

- To print the faxes in memory, you must turn off Memory Security.
- You must turn off PC Fax Receive before you can turn on Memory Security.
- If you forget the Memory Security password, please call Brother Customer Service. (➤➤Basic User's Guide: *Brother numbers*)

Setting and changing the Memory Security password



Note

If you have already set the password, you will not need to set it again.

Setting a password for the first time

Make a careful note of your password.

- 1 Press **Menu**.
- 2 Press **▲** or **▼** to display **Fax**.
- 3 Press **Fax**.
- 4 Press **▲** or **▼** to display **Miscellaneous**.
- 5 Press **Miscellaneous**.
- 6 Press **Mem Security**.
- 7 Enter a 4-digit number for the password by pressing the buttons on the Touchscreen.
Press **OK**.
- 8 When the LCD shows **Verify:**, re-enter the password by pressing the buttons on the Touchscreen.
Press **OK**.
- 9 Press **Stop/Exit**.

Changing your Memory Security password

- 1 Press **Menu**.
- 2 Press **▲** or **▼** to display **Fax**.
- 3 Press **Fax**.
- 4 Press **▲** or **▼** to display **Miscellaneous**.
- 5 Press **Miscellaneous**.
- 6 Press **Mem Security**.
- 7 Press **Set Password**.
- 8 Enter the registered 4-digit number for the current password by pressing the buttons on the Touchscreen.
Press **OK**.
- 9 Enter a 4-digit number for a new password by pressing the buttons on the Touchscreen.
Press **OK**.
- 10 When the LCD shows **Verify:**, re-enter the new password by pressing the buttons on the Touchscreen.
Press **OK**.
- 11 Press **Stop/Exit**.

Turning Memory Security on/off

Turning on Memory Security

- 1 Press **Menu**.
- 2 Press **▲** or **▼** to choose **Fax**.
- 3 Press **Fax**.
- 4 Press **▲** or **▼** to display **Miscellaneous**.
- 5 Press **Miscellaneous**.
- 6 Press **Mem Security**.
- 7 Press **Set Security**.
- 8 Enter the registered 4-digit password by pressing the buttons on the Touchscreen.
Press **OK**.
The machine goes offline and the LCD shows **Memory Security**.



Note

If there is a power failure the data will stay in memory for approximately 24 hours.

Turning off Memory Security

- 1 Press **Unlock**.
- 2 Enter the registered 4-digit password by pressing the buttons on the Touchscreen.
Press **OK**.
Memory Security is automatically turned off.



Note

If you enter the wrong password, the LCD shows **Wrong Password** and stays offline. The machine will stay in Secure mode until the registered password is entered.

Additional sending options

Sending faxes using multiple settings

When you send a fax you can choose a combination of settings, such as Fax Resolution, Contrast, Glass ScanSize, Real Time TX and Preview.

You can also choose: Call History, Speed Dial, Broadcasting, Delayed Fax, Batch TX, Polled TX, Polling RX, Overseas Mode, Set New Default, and Factory Reset.

Some settings are only available when sending black & white faxes.

- 1 Press  (FAX).
The LCD shows:

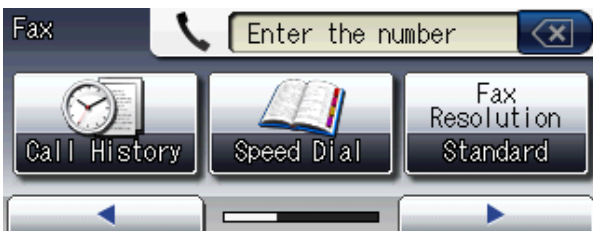

- 2 Press ◀ or ▶ to display a setting you want to change. When the setting is displayed, press it.
- 3 Press an option.
- 4 Repeat steps 2 to 3 to change more settings.

Note

- Most settings are temporary and the machine returns to its default settings after you send a fax.
- You can save some of the settings you use most often by setting them as the default. These settings will stay until you change them again. (See *Setting your changes as the new default* >> page 8.)

Stop faxing

To stop faxing, press **Stop/Exit**.

Contrast

If your document is very light or very dark, you may want to change the contrast. For most documents the factory setting **Auto** can be used. It automatically chooses the suitable contrast for your document.

Choose **Light** when sending a light document. Choose **Dark** when sending a dark document.

- 1 Press  (FAX).
- 2 Press ◀ or ▶ to display **Contrast**.
- 3 Press **Contrast**.
- 4 Press **Auto**, **Light** or **Dark**.

Note

Even if you choose **Light** or **Dark**, the machine will send the fax using the **Auto** setting in any of the following conditions:

- When you send a color fax.
- When you choose **Photo** as the Fax Resolution.

Changing fax resolution

The quality of a fax can be improved by changing the fax resolution.

- 1 Press  (FAX).
- 2 Press ◀ or ▶ to display Fax Resolution.
- 3 Press Fax Resolution.
- 4 Press the resolution you want.



Note

You can choose four different resolution settings for black & white faxes and two for color faxes.

Black & White	
Standard	Suitable for most typed documents.
Fine	Good for small print and transmits a little slower than Standard resolution.
S.Fine	Good for small print or artwork and transmits slower than Fine resolution.
Photo	Use when the document has varying shades of gray or is a photograph. Photo has the slowest transmission.

Color	
Standard	Suitable for most typed documents.
Fine	Use when the document is a photograph. The transmission time is slower than Standard resolution.

If you choose S.Fine or Photo and then use the **Color Start** key to send a fax, the machine will send the fax using the Fine setting.

Setting your changes as the new default

You can save the fax settings for Fax Resolution, Contrast, Glass ScanSize, Preview and Real Time TX you use most often by setting them as default. These settings will stay until you change them again.

- 1 Press  (FAX).
- 2 Press ◀ or ▶ to choose the setting you want to change, and then press your new option.

Repeat this step for each setting you want to change.

- 3 After changing the last setting, press ◀ or ▶ to display Set New Default.
- 4 Press Set New Default.
- 5 Press Yes.
- 6 Press **Stop/Exit**.

Restoring fax settings to the factory settings

You can restore all the fax settings you have changed to the factory settings. These settings will stay until you change them again.

- 1 Press  (FAX).
- 2 Press ◀ or ▶ to display Factory Reset.
- 3 Press Factory Reset.
- 4 Press Yes.
- 5 Press **Stop/Exit**.

Additional sending operations

Sending a fax manually

Manual transmission lets you hear the dialing, ringing and fax-receiving tones while sending a fax.



Note

To send a multiple page fax, use the ADF.

- 1 Press  (FAX).
- 2 Load your document.
- 3 To listen for a dial tone, press **Hook**.
- 4 Dial the fax number.
- 5 When you hear the fax tone, press **Black Start** or **Color Start**.
If you are using the scanner glass, press **Send** on the Touchscreen to send the fax.

Sending a fax at the end of a conversation

At the end of a conversation, you can send a fax to the other party before you both hang up.

- 1 Ask the other party to wait for fax tones (beeps) and then to press the **Start** or **Send** key before hanging up.
- 2 Press  (FAX).
- 3 Load your document.
- 4 Press **Black Start** or **Color Start**.
 - If you are using the scanner glass, press **Send** to send the fax.
- 5 Replace the handset of the external phone.

Dual Access (Black & White only)

You can dial a number and start scanning the fax into memory—even when the machine is sending from memory, receiving faxes or printing PC data. The LCD shows the new job number.

The number of pages you can scan into the memory will vary depending on the data that is printed on them.



Note

If the **Out of Memory** message appears while scanning a document, press **Stop/Exit** to cancel or **Black Start** to send the scanned pages.

Broadcasting (Black & White only)

Broadcasting is when the same fax message is automatically sent to more than one fax number. You can include Groups, Speed Dial numbers, and up to 50 manually dialed numbers in the same broadcast.

After the broadcast is finished, a Broadcast Report will be printed.

Before you begin the broadcast

Speed Dial numbers must be stored in the machine's memory before they can be used in a broadcast. (►►Basic User's Guide: *Storing Speed Dial numbers*)

Group numbers must also be stored in the machine's memory before they can be used in a broadcast. Group numbers include many stored Speed Dial numbers for easier dialing. (See *Setting up groups for Broadcasting* ►► page 32.)

How to broadcast a fax

- 1 Press  (FAX).
- 2 Load your document.
- 3 Press ◀ or ▶ to display *Advanced Settings*.
- 4 Press *Advanced Settings*.
- 5 Press ▲ or ▼ to display *Broadcasting*.
- 6 Press *Broadcasting*.

- 7 You can add numbers to the broadcast in the following ways:

- Press *Add Number* and enter a number by pressing the buttons on the Touchscreen.

Press *OK*.

- Press *Speed Dial*.

Press  to search by *Alphabetical Order* or *Numerical Order*. Press the locations where you want to send a fax.

Press *OK*.

- 8 After you have entered all the fax numbers by repeating step 7, press *OK*.

- 9 Press **Black Start**.

Faxing from the ADF

- The machine starts scanning and sending the document.

Faxing from the scanner glass

When the LCD asks you *Next Page?*, do one of the following:

- To send a single page, press *No* (or press **Black Start** again).

The machine starts sending the document.

- To send more than one page, press *Yes* and place the next page on the scanner glass.

Press **Black Start**.

The machine starts scanning the page. (Repeat this step for each additional page.)

 **Note**

- If you did not use up any of the numbers for Groups, you can broadcast faxes to as many as 250 different numbers.
- The machine's available memory will vary depending on the types of jobs in the memory and the number of locations used for broadcasting. If you broadcast to the maximum number available, you will not be able to use dual access and delayed fax.
- If the `Out of Memory` message appears, press **Stop/Exit** to stop the job. If more than one page has been scanned, press **Black Start** to send the portion that is in the machine's memory.



Canceling a Broadcast in progress

- 1 Press **Stop/Exit**.
- 2 Do one of the following:
 - To cancel the entire broadcast, press `Entire Broadcast`. Go to step 3.
 - To cancel the current job, press the button that displays the number being dialed. Go to step 4.
 - To exit without canceling, press **Stop/Exit**.
- 3 When the LCD asks if you want to cancel the entire broadcast, do one of the following:
 - Press `Yes` to confirm.
 - To exit without canceling, press `No` or **Stop/Exit**.
- 4 Do one of the following:
 - To cancel the current job, press `Yes`.
 - To exit without canceling, press `No` or **Stop/Exit**.

Real Time Transmission

When you are sending a fax, the machine will scan the document into the memory before sending it. Then, as soon as the telephone line is free, the machine will start dialing and sending.

Sometimes, you may want to send an important document immediately, without waiting for memory transmission. You can do this by turning on `Real Time TX`.



- 1 Press  (**FAX**).
- 2 Load your document.
- 3 Press ◀ or ▶ to display `Advanced Settings`.
- 4 Press `Advanced Settings`.
- 5 Press ▲ or ▼ to display `Real Time TX`.
- 6 Press `Real Time TX`.
- 7 Press `On`.
- 8 Press .

 **Note**

- If you are sending a color fax or if the memory is full and you are sending a black & white fax from the ADF, the machine will send the document in real time (even if `Real Time TX` is set to `Off`). Faxes from the scanner glass cannot be sent until you clear some of the memory.
- In Real Time Transmission, the automatic redial feature does not work when you are using the scanner glass.

Overseas Mode

If you are having difficulty sending a fax overseas due to possible interference on the telephone line, we recommend that you turn on Overseas Mode. After you send a fax using this feature, the feature will turn itself off.

- 1 Press  (FAX).
- 2 Load your document.
- 3 Press ◀ or ▶ to display Advanced Settings.
- 4 Press Advanced Settings.
- 5 Press ▲ or ▼ to display Overseas Mode.
- 6 Press Overseas Mode.
- 7 Press On (or Off).
- 8 Press .

Delayed Faxing (Black & White only)

You can store up to 50 faxes in the memory to be sent within 24 hours. These faxes will be sent at the time of day you enter in step 8.

- 1 Press  (FAX).
- 2 Load your document.
- 3 Press ◀ or ▶ to display Advanced Settings.
- 4 Press Advanced Settings.
- 5 Press ▲ or ▼ to display Delayed Fax.
- 6 Press Delayed Fax.
- 7 Press On.
- 8 Enter the time you want the fax to be sent (in 24-hour format) by pressing the buttons on the Touchscreen.
(For example, enter 19:45 for 7:45 PM.)
Press OK.



Note

- When you set 12h Clock in the Date&Time setting, enter the time in 12-hour format.
 - The number of pages you can scan into the memory depends on the amount of data that is printed on each page.
-

Delayed Batch Transmission (Black & White only)

Before sending the delayed faxes, your machine will help you economize by sorting all the faxes in the memory by destination and scheduled time. All delayed faxes that are scheduled to be sent at the same time to the same fax number will be sent as one fax to save transmission time.

- 1 Press  (FAX).
- 2 Press ◀ or ▶ to display Advanced Settings.
- 3 Press Advanced Settings.
- 4 Press ▲ or ▼ to display Batch TX.
- 5 Press Batch TX.
- 6 Press On.
- 7 Press **Stop/Exit**.

Checking and canceling waiting jobs

You can check which jobs are still waiting in the memory to be sent and cancel a job. (If there are no jobs, the LCD shows No Jobs Waiting.)

- 1 Press Menu.
- 2 Press ▲ or ▼ to display Fax.
- 3 Press Fax.
- 4 Press ▲ or ▼ to display Remaining Jobs.
- 5 Press Remaining Jobs. Any waiting jobs appear on the LCD.
- 6 Press ▲ or ▼ to scroll through the jobs and press the job you want to cancel. Press OK.
- 7 Do one of the following:
 - To cancel, press Yes.
If you want to cancel another job go to step 6.
 - To exit without canceling, press No.
- 8 When you are finished, press **Stop/Exit**.

Polling overview

Polling lets you set up your machine so other people can receive faxes from you, but they pay for the call. It also lets you call somebody else's fax machine and receive a fax from it, so you pay for the call. The polling feature needs to be set up on both machines for this to work. Not all fax machines support polling.

Polled Transmit (Black & White only)

Polled transmit lets you set up your machine to wait with a document so another fax machine can call and retrieve it.

The document will be stored and can be retrieved by any other fax machine until you delete it from the memory. (See *Checking and canceling waiting jobs* >> page 13.)

Setup for polled transmit

- 1 Press  (FAX).
- 2 Load your document.
- 3 Press ◀ or ▶ to display Advanced Settings.
- 4 Press Advanced Settings.
- 5 Press ▲ or ▼ to display Polled TX.
- 6 Press Polled TX.
- 7 Press On (or Off).
- 8 Press ◀ or ▶ to display any settings you want to change, and press it. Then choose your option. After each setting is accepted, you can continue to change more settings.
- 9 Press **Black Start**.

- 10 If you are using the scanner glass, the LCD will prompt you to choose one of the following options:

- Press **Yes** to scan another page. Go to step 11.
- Press **No** or **Black Start** to send the document.

- 11 Place the next page on the scanner glass and press **Black Start**. Repeat steps 10 and 11 for each additional page. Your machine will automatically send the fax.

Memory Receive (Black & White only)

You can only use one Memory Receive operation at a time:

- Fax Forwarding
- Paging
- Fax Storage
- PC-Fax Receive
- Off

You can change your selection at any time. If received faxes are still in the machine's memory when you change the Memory Receive operation, a message will appear on the LCD. (See *Changing Memory Receive operations* >> page 19.)

Receiving faxes into memory when paper tray is empty

As soon as the paper tray becomes empty during fax reception, the LCD shows `No Paper Fed.` Put some paper in the paper tray. (>>Basic User's Guide: *Loading paper and other print media*)

If you don't put paper in the paper tray, the machine will carry on receiving the fax, with the remaining pages being stored in memory, if enough memory is available.

Further incoming faxes will also be stored in memory until the memory is full. When the memory is full the machine will stop automatically answering calls. To print the faxes, put fresh paper in the tray.

Fax Forwarding

When you choose Fax Forward, your machine stores the received fax in the memory. The machine will then dial the fax number you have programmed and forward the fax message.

- 1 Press `Menu`.
- 2 Press `▲` or `▼` to display `Fax`.
- 3 Press `Fax`.
- 4 Press `▲` or `▼` to display `Setup Receive`.
- 5 Press `Setup Receive`.
- 6 Press `▲` or `▼` to display `Memory Receive`.
- 7 Press `Memory Receive`.
- 8 Press `Fax Forward`.
- 9 Enter the forwarding number (up to 20 digits) by pressing the buttons on the Touchscreen.
Press `OK`.
- 10 Press `Backup Print:On` or `Backup Print:Off`.

! IMPORTANT

- If you choose `Backup Print:On`, the machine will also print the fax at your machine so you will have a copy. This is a safety feature in case there is a power failure before the fax is forwarded or a problem at the receiving machine.
- When you receive a color fax, your machine prints the color fax at your machine but does not send the fax to the fax forwarding number you programmed.

- 11 Press **Stop/Exit**.

Paging

When you choose Paging, your machine dials the cell phone or pager number you have programmed. This activates your cell phone or pager so you will know that you have a fax message in the memory.

If you have set Paging, a backup copy of the received fax will automatically be printed at the machine.

- 1 Press `Menu`.
- 2 Press **▲** or **▼** to display `Fax`.
- 3 Press `Fax`.
- 4 Press **▲** or **▼** to display `Setup Receive`.
- 5 Press `Setup Receive`.
- 6 Press **▲** or **▼** to display `Memory Receive`.
- 7 Press `Memory Receive`.
- 8 Press `Paging`.

- 9 Enter your cell phone or pager number followed by `# #` (up to 20 digits).

Press `OK`.

Do not include the area code if it is the same as that of your machine.

For example, press:

1 8 0 0 5 5 5 1 2 3 4 # #.

- 10 Do one of the following:

- If you are programming your cell phone number and do not need to enter a PIN, press `OK`.
- If your pager needs a PIN, enter the PIN, press `#`, press `Pause`, and then enter your fax number followed by `# #`.

Press `OK`.

For example, press:

1 2 3 4 5 # Pause 1 8 0 0 5 5 5 6 7
8 9 # #

- If you do not need a PIN, press:

`Pause`, and then enter your fax number followed by `# #`. Press `OK`.

For example, press:

Pause 1 8 0 0 5 5 5 6 7 8 9 # #

- 11 Press **Stop/Exit**.



Note

You cannot change a paging number or PIN remotely.

Fax Storage

If you choose Fax Storage, your machine stores received faxes in the memory. You will be able to retrieve fax messages from another location using the remote retrieval commands.

If you have turned on Fax Storage, a backup copy will automatically be printed at the machine.

- 1 Press **Menu**.
- 2 Press **▲** or **▼** to display **Fax**.
- 3 Press **Fax**.
- 4 Press **▲** or **▼** to display **Setup Receive**.
- 5 Press **Setup Receive**.
- 6 Press **▲** or **▼** to display **Memory Receive**.
- 7 Press **Memory Receive**.
- 8 Press **Fax Storage**.
- 9 Press **Stop/Exit**.



Note

Color faxes cannot be stored in the memory. When you receive a color fax your machine prints the color fax at your machine.

Printing a fax from the memory

If you have chosen Paging or Fax Storage, you can still print a fax from the memory when you are at your machine. (See *Memory Receive (Black & White only)* ►► page 15.)

- 1 Press **Menu**.
- 2 Press **▲** or **▼** to display **Fax**.
- 3 Press **Fax**.
- 4 Press **▲** or **▼** to display **Print Fax**.
- 5 Press **Print Fax**.
- 6 Press **Black Start**.
- 7 Press **Stop/Exit**.



Note

When you print a fax from the memory, the fax data will be erased.

PC-Fax Receive (Windows® only)

If you turn on the PC-Fax Receive feature your machine will store received faxes in memory and send them to your PC automatically. You can then use your PC to view and store these faxes.

Even if you have turned off your PC (at night or on the weekend, for example), your machine will receive and store your faxes in its memory. The number of received faxes that are stored in the memory will appear on the LCD.

When you start your PC and the PC-FAX Receiving software runs, your machine transfers your faxes to your PC automatically.

To transfer the received faxes to your PC you must have the PC-FAX Receiving software running on your PC.

(▶▶Software User's Guide: *PC-FAX receiving*)

If you choose `Backup Print:On` the machine will also print the fax.

- 1 Press `Menu`.
- 2 Press `▲` or `▼` to display `Fax`.
- 3 Press `Fax`.
- 4 Press `▲` or `▼` to display `Setup Receive`.
- 5 Press `Setup Receive`.
- 6 Press `▲` or `▼` to display `Memory Receive`.
- 7 Press `Memory Receive`.
- 8 Press `PC Fax Receive`.
- 9 The LCD shows the message `Run PC-Fax on your computer`. Press `OK`.

- 10 Press `<USB>` or, for network users, the name of the PC you want to receive faxes.

- 11 Press `OK`.

- 12 Press `Backup Print:On` or `Backup Print:Off`.

- 13 Press **Stop/Exit**.



Note

- PC-Fax Receive is not supported by the Mac OS.
- Before you can set up PC-Fax Receive you must install the MFL-Pro Suite software on your PC. Make sure your PC is connected and turned on. (▶▶Software User's Guide: *PC-FAX receiving*)
- If you get an error message and the machine cannot print the faxes in memory, you can use this setting to transfer your faxes to your PC. (▶▶Basic User's Guide: *Transferring your faxes or Fax Journal report*)
- When you receive a color fax, your machine prints the color fax at your machine but does not send the fax to your PC.
- To change the destination PC, repeat steps 1 to 13.

Turning off Memory Receive operations

- 1 Press **Menu**.
- 2 Press **▲** or **▼** to display **Fax**.
- 3 Press **Fax**.
- 4 Press **▲** or **▼** to display **Setup Receive**.
- 5 Press **Setup Receive**.
- 6 Press **▲** or **▼** to display **Memory Receive**.
- 7 Press **Memory Receive**.
- 8 Press **Off**.
- 9 Press **Stop/Exit**.



Note

The LCD will give you more options if there are received faxes still in the machine's memory. (See *Changing Memory Receive operations* >> page 19.)

Changing Memory Receive operations

If received faxes remain in your machine's memory when you change the Memory Receive Operations, the LCD will ask you one of the following questions:

- Erase All Fax?
- Print All Fax?
 - If you press **Yes**, faxes in the memory will be erased or printed before the setting changes. If a backup copy has already been printed it will not be printed again.
 - If you press **No**, faxes in the memory will not be erased or printed and the setting will be unchanged.

If received faxes are left in the machine's memory when you change to **PC Fax Receive** from another option [Fax Forward, Paging or Fax Storage], press **▲** or **▼** to choose the **PC**.

The LCD will ask you the following question:

- Send Fax to PC?
 - If you press **Yes**, faxes in the memory will be sent to your PC before the setting changes. You will be asked if you want to turn on Backup Print. (For details, see *PC-Fax Receive (Windows® only)* >> page 18.)
 - If you press **No**, faxes in the memory will not be erased or transferred to your PC and the setting will be unchanged.

Remote Retrieval

You can call your machine from any touch-tone telephone or fax machine and then use the remote access code and remote commands to retrieve fax messages.

Setting a Remote Access Code

The Remote Access Code lets you access the remote retrieval features when you are away from your machine. Before you can use the remote access and retrieval features, you have to set up your own code. The factory default code is the inactive code (---*).

- 1 Press **Menu**.
- 2 Press **▲** or **▼** to display **Fax**.
- 3 Press **Fax**.
- 4 Press **▲** or **▼** to display **Remote Access**.
- 5 Press **Remote Access**.
- 6 Enter a three-digit code using numbers 0-9, *, or # by pressing the buttons on the Touchscreen.
Press **OK**.
(The preset '*' cannot be changed.)



Note

Do not use the same code as your Fax Receive Code (* 5 1) or Telephone Answer Code (# 5 1).
(▶▶Basic User's Guide: *Using external and extension telephones*)

- 7 Press **Stop/Exit**.



Note

You can change your code at any time by entering a new one. If you want to make your code inactive, press **Clear** in step 6 to restore the inactive setting (---*) and press **OK**.

Using your Remote Access Code

- 1 Dial your fax number from a touch-tone telephone or another fax machine.
- 2 When your machine answers, enter your remote access code (3 digits followed by *) at once.
- 3 The machine signals if it has received messages:
 - 1 long beep — Fax messages
 - No beeps — No messages
- 4 When the machine gives two short beeps, enter a command.
The machine will hang up if you wait longer than 30 seconds to enter a command.
The machine will beep three times if you enter an invalid command.
- 5 Press **9 0** to stop Remote Access when you have finished.
- 6 Hang up.



Note

If your machine is set to **Manual** mode and you want to use the remote retrieval features, wait for about 100 seconds after it starts ringing, and then enter the remote access code within 30 seconds.

Remote Fax commands

Follow the commands below to access features when you are away from the machine. When you call the machine and enter your remote access code (3 digits followed by *), the system will give two short beeps and you must enter a remote command.

Remote commands		Operation details
95	Change the Fax Forwarding, Paging or Fax Storage settings	
	1 OFF	You can choose OFF after you have retrieved or erased all your messages.
	2 Fax Forwarding	One long beep means the change is accepted. If you hear three short beeps, you cannot make a change because something has not been set up (for example, a Fax Forwarding or Paging number has not been registered).
	3 Paging	
	4 Fax Forwarding number	
6 Fax Storage	You can register your Fax Forwarding number by entering 4. (See <i>Changing your Fax Forwarding number</i> >> page 22.) Once you have registered the number, Fax Forwarding will work.	
96	Retrieve a fax	
	2 Retrieve all faxes	Enter the number of a remote fax machine to receive stored fax messages. (See <i>Retrieving fax messages</i> >> page 22.)
	3 Erase faxes from the memory	If you hear one long beep, fax messages have been erased from the memory.
97	Check the receiving status	
	1 Fax	You can check whether your machine has received any faxes. If yes, you will hear one long beep. If no, you will hear three short beeps.
98	Change the Receive Mode	
	1 External TAD	If you hear one long beep, your change has been accepted.
	2 Fax/Tel	
	3 Fax Only	
90	Exit	Pressing 90 allows you to exit remote retrieval. Wait for the long beep, then replace the handset.

Retrieving fax messages

You can call your machine from any touch-tone telephone and have your fax messages sent to another machine. Before you use this feature, you have to turn on Fax Storage.

- 1 Dial your fax number.
- 2 When your machine answers, enter your remote access code (3 digits followed by *) at once. If you hear one long beep, you have messages.
- 3 When you hear two short beeps, press **9 6 2**.
- 4 Wait for a long beep, and then use the dial pad to enter the number of the remote fax machine where you want your fax messages sent, followed by **# #** (up to 20 digits).



Note

You cannot use * and # as dial numbers. However, press # if you want to create a pause.

- 5 Hang up after you hear your machine beep. Your machine will call the other fax machine, which will then print your fax messages.

Changing your Fax Forwarding number

You can change the default setting of your fax forwarding number from another touch-tone telephone or fax machine.

- 1 Dial your fax number.
- 2 When your machine answers, enter your remote access code (3 digits followed by *) at once. If you hear one long beep, you have messages.
- 3 When you hear two short beeps, press **9 5 4**.
- 4 Wait for the long beep, enter the new number (up to 20 digits) of the remote fax machine you want your fax messages forwarded to using the dial pad, then enter **# #**.



Note

You cannot use * and # as dial numbers. However, press # if you want to create a pause.

- 5 Press **9 0** to stop Remote Access when you have finished.
- 6 Hang up after you hear your machine beep.

Additional receiving operations

Printing a reduced incoming fax

If you choose **On**, the machine automatically reduces each page of an incoming fax to fit on one page of Letter, Legal or A4 size paper. The machine calculates the reduction ratio by using the page size of the fax and your Paper Size setting. (►►Basic User's Guide: *Paper Size*)

- 1 Press **Menu**.
- 2 Press **▲** or **▼** to display **Fax**.
- 3 Press **Fax**.
- 4 Press **▲** or **▼** to display **Setup Receive**.
- 5 Press **Setup Receive**.
- 6 Press **▲** or **▼** to display **Auto Reduction**.
- 7 Press **Auto Reduction**.
- 8 Press **On** (or **Off**).
- 9 Press **Stop/Exit**.

Receiving a fax at the end of a conversation

At the end of a conversation, you can ask the other party to fax you information before you both hang up.

- 1 Ask the other party to place the document in their machine and to press the **Start** or **Send** key.
- 2 When you hear the other machine's CNG tones (slowly repeating beeps), press **Black Start** or **Color Start**.
- 3 Press **Receive** to receive the fax.
- 4 Replace the handset of the external telephone.

Polling overview

Polling lets you set up your machine so other people can receive faxes from you, but they pay for the call. It also lets you call somebody else's fax machine and receive a fax from it, so you pay for the call. The polling feature needs to be set up on both machines for this to work. Not all fax machines support polling.

Polling receive



Polling receive lets you call another fax machine to receive a fax.

Setup to receive polling

- 1 Press  (FAX).
- 2 Press ◀ or ▶ to display Advanced Settings.
- 3 Press Advanced Settings.
- 4 Press ▲ or ▼ to display Polling RX.
- 5 Press Polling RX.
- 6 Press On (or Off).
- 7 Enter the fax number you are polling using Speed Dial or the dial pad on the control panel.
- 8 Press **Black Start** or **Color Start**.
The LCD shows *Dialing*.

Sequential polling (Black & White only)

Sequential polling lets you request documents from several fax machines in one operation. Afterwards, a Sequential Polling Report will be printed.

- 1 Press  (FAX).
- 2 Press ◀ or ▶ to display Advanced Settings.
- 3 Press Advanced Settings.
- 4 Press ▲ or ▼ to display Polling RX.
- 5 Press Polling RX.
- 6 Press On (or Off).
- 7 Press ◀ or ▶ to display Advanced Settings.
- 8 Press Advanced Settings.
- 9 Press ▲ or ▼ to display Broadcasting.
- 10 Press Broadcasting.
- 11 Do one of the following:
 - Press *Add Number* and enter a number by pressing the buttons on the Touchscreen.
Press *OK*.
 - Press *Speed Dial*. Press  to choose Alphabetical Order or Numerical Order. Press ▲ or ▼ to select a number.
Press *OK*.
- 12 After you have entered all the fax numbers by repeating step 11, press *OK*.
- 13 Press **Black Start**.
The machine polls each number or Group number in turn for a document.

Press **Stop/Exit** while the machine is dialing to cancel the polling process.

To cancel all sequential polling receive jobs, see *Checking and canceling waiting jobs* >> page 13.

Canceling a Sequential Polling Job

- 1 Press **Stop/Exit**.
- 2 Do one of the following:
 - To cancel the entire sequential polling job, press `Entire Seq. Poll.` Go to step 3.
 - To cancel the current job, press the button that displays the number being dialed. Go to step 4.
 - To exit without canceling, press **Stop/Exit**.
- 3 When the LCD asks if you want to cancel the entire sequential polling job, do one of the following:
 - Press `Yes` to confirm.
 - To exit without canceling, press `No` or **Stop/Exit**.
- 4 Do one of the following:
 - To cancel the current job, press `Yes`.
 - To exit without canceling, press `No` or **Stop/Exit**.

Voice operations

Voice calls can be made with an external telephone by dialing manually.

Tone or Pulse (Canada only)

If you have a Pulse dialing service, but need to send tone signals (for example, for telephone banking), follow the instructions below:

- 1 Press **Hook**.
- 2 Press **#** on the machine's control panel. Any digits dialed after this will send tone signals.

When you are finished with the call, the machine will return to the Pulse dialing service.

Fax/Tel mode

When the machine is in Fax/Tel mode, it will use the F/T Ring (pseudo/double-ringing) to alert you to pick up a voice call.

If you are at the extension telephone, you'll need to lift the handset during the F/T Ring and then press **# 5 1** between the pseudo/double-rings. If no one is on the line, or if someone wants to send you a fax, send the call back to the machine by pressing *** 5 1**.

If you are at the machine, lift the external telephone's handset, and then press **Hook** to answer.

Caller ID

The Caller ID feature lets you use the Caller ID subscriber service offered by many local telephone companies. Call your telephone company for details. This service shows the telephone number, or name if it is available, of your caller as the line rings.

After a few rings, the LCD shows the telephone number of your caller (and name, if available). Once you answer a call, the Caller ID information disappears from the LCD, but the call information stays stored in the Caller ID memory.

You can view the list or choose one of these numbers to fax to, add to Speed Dial, or delete from the history. (See *Caller ID history* >> page 29.)

- You can see the number (or name).
- The **# Unavailable** message means the call originated outside your Caller ID service area.
- The **Private Call** message means the caller has intentionally blocked transmission of Caller ID information.

You can print a list of the Caller ID information received by your machine. (See *How to print a report* >> page 35.)



Note

- This feature may not be available in certain areas of the USA and Canada.
- The Caller ID service varies with different carriers. Call your local telephone company to find out about the kind of service available in your area.

Setting up your area code (USA only)

When returning calls from the Caller ID history your machine will automatically dial “1” plus the area code for all calls. If your local dialing plan requires that the “1” not be used for calls within your area code, enter your area code in this setting. With the area code setting, calls returned from the Caller ID history to numbers *within* your area code will be dialed using 10 digits (area code + 7-digit number). If your dialing plan does not follow the standard 1 + area code + 7-digit number dialing system for calling *outside* your area code, you may experience problems returning calls automatically from the Caller ID history. If this is not the procedure followed by your dialing plan, you will not be able to return calls automatically.

- 1 Press **Menu**.
- 2 Press **▲** or **▼** to display **Fax**.
- 3 Press **Fax**.
- 4 Press **▲** or **▼** to display **Miscellaneous**.
- 5 Press **Miscellaneous**.
- 6 Press **Area Code**.
- 7 Enter your Area Code (3-digit number), and press **OK**.
- 8 Press **Stop/Exit**.

Special line considerations

Roll-over telephone lines

A roll-over telephone system is a group of two or more separate telephone lines that pass incoming calls to each other if they are busy. The calls are usually passed down or “rolled over” to the next available telephone line in a preset order.

Your machine can work in a roll-over system as long as it is the last number in the sequence so the call cannot roll away. Do not put the machine on any of the other numbers; when the other lines are busy and a second fax call is received, the fax call will be sent to a line that does not have a fax machine. **Your machine will work best on a dedicated line.**

Two-line telephone system

A two-line telephone system is nothing more than two separate telephone numbers on the same wall outlet. The two telephone numbers can be on separate jacks (RJ11) or mixed into one jack (RJ14). Your machine must be plugged into an RJ11 jack. RJ11 and RJ14 jacks may be equal in size and appearance and both may contain four wires (black, red, green, yellow). To test the type of jack, plug in a two-line telephone and see if it can access both lines. If it can, you must separate the line for your machine.

Converting telephone wall outlets

There are three ways to convert to an RJ11 jack. The first two ways may require help from the telephone company. You can change the wall outlets from one RJ14 jack to two RJ11 jacks. Or, you can have an RJ11 wall outlet installed and slave or jump one of the telephone numbers to it.

The third way is the easiest: Buy a triplex adapter. You can plug a triplex adapter into an RJ14 outlet. It separates the wires into two separate RJ11 jacks (Line 1, Line 2) and a third RJ14 jack (Lines 1 and 2). If your machine is on Line 1, plug the machine into L1 of the triplex adapter. If your machine is on Line 2, plug it into L2 of the triplex adapter.

Triplex Adapter

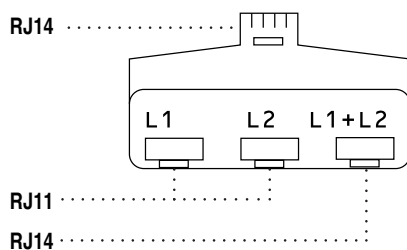

Installing machine, external two-line TAD and two-line telephone

When you are installing an external two-line telephone answering device (TAD) and a two-line telephone, your machine must be isolated on one line at both the wall jack and at the TAD. The most common connection is to put the machine on Line 2, which is explained in the following steps. The back of the two-line TAD must have two telephone jacks: one labeled L1 or L1/L2, and the other labeled L2. You will need at least three telephone line cords: the one that came with your machine and two for your external two-line TAD. You will need a fourth line cord if you add a two-line telephone.

- 1 Put the two-line TAD and the two-line telephone next to your machine.

- 2 Plug one end of the telephone line cord for your machine into the L2 jack of the triplex adapter. Plug the other end into the LINE jack on the back of the machine.
- 3 Plug one end of the first telephone line cord for your TAD into the L1 jack of the triplex adapter. Plug the other end into the L1 or L1/L2 jack of the two-line TAD.
- 4 Plug one end of the second telephone line cord for your TAD into the L2 jack of the two-line TAD. Plug the other end into the EXT. jack on the left side of the machine.

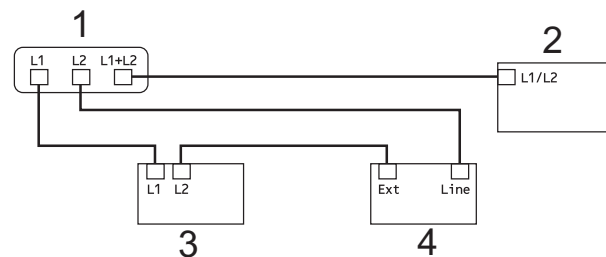

- 1 Triplex Adapter
- 2 Two Line Telephone
- 3 External Two Line TAD
- 4 Machine

Your additional two-line telephones on other wall outlets do not require adapters. There are two ways to add a two-line telephone to the machine's wall outlet. You can plug the telephone line cord from the two-line telephone into the L1+L2 jack of the triplex adapter. Or, you can plug the two-line telephone into the TEL jack of the two-line TAD.

Additional dialing operations

Outgoing Call

The last 30 numbers you sent a fax to will be stored in the outgoing call history. You can choose one of these numbers to fax to, add to Speed Dial, or delete from the history.

- 1 Press **Redial/Pause**.
You can also press .
- 2 Press the **Outgoing Call** tab.
- 3 Press the number you want.
- 4 Do one of the following:
 - To send a fax, press **Send a fax**.
Press **Black Start** or **Color Start**.
 - If you want to store the number, press **More** and then press **Add to Speed Dial**.
(See *Storing Speed Dial numbers from Outgoing Calls* >> page 31.)
 - If you want to delete the number from the Outgoing Call history list, press **More** and then press **Delete**.
Press **Yes** to confirm.
Press **Stop/Exit**.

Caller ID history

This feature requires the Caller ID subscriber service offered by many local telephone companies. (See *Caller ID* >> page 26.)

The number, or name if available, from the last 30 fax and telephone calls you received will be stored in the Caller ID history. You can view the list or choose one of these numbers to fax to, add to Speed Dial, or delete from the history. When the thirty-first call comes into the machine, it replaces information about the first call.



Note

If you are not a Caller ID subscriber, Caller ID history only allows you to view and delete the dates of calls.

- 1 Press **Redial/Pause**.
You can also press .
- 2 Press **Caller ID hist.**
- 3 Press **▲** or **▼** to display the number or the name you want to call.
- 4 Press the number or the name you want to call.
- 5 Do one of the following:
 - To send a fax, press **Send a fax**.
Press **Black Start** or **Color Start**.
 - If you want to store the number, press **More** and then press **Add to Speed Dial**.
(See *Storing Speed Dial numbers from the Caller ID history* >> page 31.)
 - If you want to delete the number from the Caller ID history list, press **More** and then press **Delete**.
Press **Yes** to confirm.
Press **Stop/Exit**.

**Note**

- (USA only) If you redial from the Caller ID history outside your area code, you must set up your AREA CODE in advance. (See *Setting up your area code (USA only)* >> page 27.)
- You can print the Caller ID List. (See *How to print a report* >> page 35.)

Dialing access codes and credit card numbers

Sometimes, you may want to choose from several long distance carriers when you send a fax. Rates may vary depending on the time and destination. To take advantage of low rates, you can store the access codes of long-distance carriers and credit card numbers as Speed Dial numbers. You can store these long dialing sequences by dividing them and setting them up as separate Speed Dial numbers in any combination. You can even include manual dialing using the dial pad. (>>Basic User's Guide: *Storing Speed Dial numbers*)

For example, you might have stored "555" on Speed Dial: 03 and "7000" on Speed Dial: 02. You can use them both to dial "555-7000" if you press the following buttons on the Touchscreen:

- 1 Press .
- 2 Press #03.
- 3 Press Send a fax.
- 4 Press Speed Dial.
- 5 Press #02.
- 6 Press Send a fax.
- 7 Press **Black Start** or **Color Start**. You will dial "555-7000".

To temporarily change a number, you can substitute part of the number with manual dialing using the dial pad. For example, to change the number to 555-7001 you could

press , press #03, press Send a fax and then press **7001** using the dial pad.

**Note**

If you must wait for another dial tone or signal at any point in the dialing sequence, create a pause in the number by pressing **Redial/Pause**. Each key press adds a 3.5-second delay.

Additional ways to store numbers

Storing Speed Dial numbers from Outgoing Calls

You can also store Speed Dial numbers from the Outgoing Call history.

- 1 Press **Redial/Pause**.
You can also choose the number by pressing .
- 2 Press the **Outgoing Call** tab.
- 3 Press **▲** or **▼** to display the name or number you want to store.
- 4 Press the name or number you want to store.
- 5 Press **More**.
- 6 Press **Add to Speed Dial**.
- 7 Do one of the following:
 - Enter the name (up to 16 characters) by pressing the buttons on the Touchscreen.
(▶▶Basic User's Guide: *Entering Text*)
Press **OK**.
 - To store the number without a name, press **OK**.
- 8 Press **OK** to confirm the fax or telephone number you want to store.
- 9 Do one of the following:
 - Enter the second fax or telephone number (up to 20 digits) by pressing the buttons on the Touchscreen.
Press **OK**.
 - If you do not want to store a second number, press **OK**.

- 10 To choose where the number will be stored, do one of the following:
 - To accept the displayed next available Speed Dial location, press **OK**.
 - To enter a different Speed Dial location, press  and a 2-digit number by pressing the buttons on the Touchscreen.
Press **OK**.



Note

If the 2-digit Speed Dial location you choose is already taken, the **OK** button on the LCD will not work. Choose a different location.

- 11 When the LCD displays your settings, press **OK** to confirm.
- 12 Press **Stop/Exit**.

Storing Speed Dial numbers from the Caller ID history

If you have the Caller ID subscriber service from your telephone company, you can also store Speed Dial numbers from incoming calls in the Caller ID History. (See *Caller ID* ▶▶ page 26)

- 1 Press **Redial/Pause**.
You can also choose the number by pressing .
- 2 Press the **Caller ID hist.** tab.
- 3 Press **▲** or **▼** to display the number you want to store.
- 4 Press the number you want to store.
- 5 Press **More**.
- 6 Press **Add to Speed Dial**.

- 7 Do one of the following:
 - If you want to store the displayed name, press **OK**.
 - Enter the name (up to 16 characters) by pressing the buttons on the Touchscreen.
(▶▶Basic User's Guide: *Entering Text*)
Press **OK**.
 - To store the number without a name, press **OK**.
- 8 Press **OK** to confirm the fax or telephone number you want to store.
- 9 Do one of the following:
 - Enter a second fax or telephone number (up to 20 digits) by pressing the buttons on the Touchscreen.
Press **OK**.
 - If you do not want to store a second number, press **OK**.
- 10 To choose where the number will be stored, do one of the following:
 - To accept the displayed next available Speed Dial location, press **OK**.
 - To enter a different Speed Dial location, press  and a 2-digit number by pressing the buttons on the Touchscreen.
Press **OK**.



Note

If the 2-digit Speed Dial location you choose is already taken, the **OK** button on the LCD will not work. Choose a different location.



- 11 When the LCD displays your settings, press **OK** to confirm.
- 12 Press **Stop/Exit**.

Setting up groups for Broadcasting

Groups, which can be stored on a Speed Dial location, allow you to send the same fax message to many fax numbers by pressing , the two-digit location, **Send a fax** and **Black Start**.

First, you'll need to store each fax number in Speed Dial location. (▶▶Basic User's Guide: *Storing Speed Dial numbers*) Then you can include them as numbers in the Group. Each Group uses up a Speed Dial location. You can have up to six Groups, or you can assign up to 198 numbers to a large Group.

(See *Broadcasting (Black & White only)* ▶▶ page 10.)

- 1 Press .
- 2 Press **More**.
- 3 Press **Setup Groups**.
- 4 Enter the group name (up to 16 characters) by pressing the buttons on the Touchscreen.
Press **OK**.
- 5 When the LCD displays the next available Group number, press **OK**. This Group number and name will automatically be assigned to the next available Speed Dial location.
- 6 Add Speed Dial numbers to the Group by pressing them to display a red checkmark. Press **OK**.
If you want to list the numbers in alphabetical order, press .
- 7 When the LCD displays the Group Name and numbers, press **OK** to confirm.

- 8 Do one of the following:
 - To store another Group for broadcasting, repeat steps 2 to 7.
 - To finish storing Groups for broadcasting, press **Stop/Exit**.



Note

You can print a list of all the Speed Dial numbers. Group numbers will be marked in the GROUP column. (See *Reports* >> page 35.)

Changing a Group name

- 1 Press .
- 2 Press **More**.
- 3 Press **Change**.
- 4 Press **▲** or **▼** to display the Group you want to change.
- 5 Press the Group.
- 6 Press **Name : .**
- 7 Enter the new name (up to 16 characters) by pressing the buttons on the Touchscreen.
(>>>Basic User's Guide: *Entering Text*)
Press **OK**.
(For example, type NEW CLIENTS.)



Note

How to change the stored name or number:

If you want to change a character, press **◀** or **▶** to position the cursor under the character you want to change, and then press . Re-enter the character.

- 8 Press **OK**.
- 9 Press **Stop/Exit**.

Deleting a Group

- 1 Press .
- 2 Press **More**.
- 3 Press **Delete**.
- 4 Press **▲** or **▼** to display the Group you want to delete.
- 5 Press the Group Name.
- 6 Press **OK**.
Press **Yes** to confirm.
- 7 Press **Stop/Exit**.

Deleting a number from a Group

- 1 Press .
- 2 Press **More**.
- 3 Press **Change**.
- 4 Press **▲** or **▼** to display the Group you want to change.
- 5 Press the Group.
- 6 Press **Add/Del**.
- 7 Press **▲** or **▼** to display the number you want to delete from the Group.
- 8 Press the check box of the number you want to delete to uncheck it.
Press **OK** to confirm.
- 9 Press **OK**.
- 10 Press **Stop/Exit**.

6

Printing reports

Fax reports

Use the **Menu** button on the LCD to set up the Transmission Verification Report and the Journal Period.

Transmission Verification Report

You can use the Transmission Verification Report as proof that you sent a fax.
(▶▶ Basic User's Guide: *Transmission Verification Report*)

Fax Journal (activity report)

You can set the machine to print a journal at specific intervals (every 50 faxes, 6, 12 or 24 hours, 2 or 7 days). If you set the interval to **Off**, you can still print the report by following the steps in *How to print a report* ▶▶ page 35. The factory setting is **Every 50 Faxes**.

- 1 Press **Menu**.
- 2 Press **▲** or **▼** to display **Fax**.
- 3 Press **Fax**.
- 4 Press **▲** or **▼** to display **Report Setting**.
- 5 Press **Report Setting**.
- 6 Press **Journal Period**.

- 7 Press **◀** or **▶** to choose an interval. If you choose **Every 50 Faxes**, go to step 10.

- **6, 12, 24 hours, 2 or 7 days**

The machine will print the report at the chosen time and then erase all jobs from its memory. If the machine's memory becomes full with 200 jobs before the time you chose has passed, the machine will print the Journal early and then erase all jobs from the memory. If you want an extra report before it is due to print, you can print it without erasing the jobs from the memory.

- **Every 50 Faxes**

The machine will print the Journal when the machine has stored 50 jobs.

- 8 Enter the time to start printing in 24-hour format. Press **OK**.
(For example: enter 19:45 for 7:45 PM.)



Note

When you set **12h Clock** in the **Date&Time** setting, enter the time in 12-hour format.

- 9 If you choose **Every 7 Days**, the LCD will ask you to choose the first day for the 7-day countdown.
- 10 Press **Stop/Exit**.

Reports

The following reports are available:

- **Transmission**
Prints a Transmission Verification Report for your last transmission.
- **Quick Dial**
Lists names and numbers stored in the Speed Dial memory, in alphabetical or numerical order.
- **Fax Journal**
Lists information about the last incoming and outgoing faxes.
(TX: Transmit.) (RX: Receive.)
- **User Settings**
Lists your settings.
- **Network Config**
Lists your Network settings.
- **WLAN Report**
Prints the result of the WLAN connection.
- **Caller ID hist.**
Lists the available Caller ID information about the last 30 received faxes and telephone calls.

How to print a report

- 1 Press **Menu**.
- 2 Press **▲** or **▼** to display **Print Reports**.
- 3 Press **Print Reports**.
- 4 Press the report you want.
- 5 (Quick Dial Only) Press **Alphabetical Order** or **Numerical Order**.
- 6 Press **Black Start**.
- 7 Press **Stop/Exit**.

Copy settings

You can change the copy settings temporarily for the next copy.

These settings are temporary. The machine returns to its default settings 1 minute after copying unless you have set the Mode Timer to 30 seconds or less. (See *Mode Timer* >> page 4.)

To change a setting, press **COPY** and then press ◀ or ▶ to scroll through the copy settings. When the setting you want is displayed, press it and choose your option.

When you are finished choosing settings, press **Black Start** or **Color Start**.



Note

- You can save some of the settings that you use most often by setting them as default. These settings will stay until you change them again. (See *Setting your favorites* >> page 45.)
- The Ink Save Mode, Thin Paper Copy, Book Copy and Watermark Copy features are supported by technology from Reallusion,

Inc.  **REALLUSION**

Stop copying

To stop copying, press **Stop/Exit**.

Changing copy quality

You can choose from a range of quality. The factory setting is **Normal**.

■ Fast

Fast copy speed and lowest amount of ink used. Use to save time printing documents to be proof-read, large documents or many copies.

■ Normal

Normal is the recommended mode for ordinary printouts. This produces good copy quality with good copy speed.

■ Best

Use Best mode to copy precise images such as photographs. This provides the highest resolution and slowest speed.

- 1 Press  (**COPY**).
- 2 Load your document.
- 3 Enter the number of copies you want.
- 4 Press ◀ or ▶ to display **Quality**.
- 5 Press **Quality**.
- 6 Press **Fast**, **Normal** or **Best**.
- 7 If you do not want to change additional settings, press **Black Start** or **Color Start**.

Enlarging or reducing the copied image

You can choose an enlargement or reduction ratio. If you choose **Fit to Page**, your machine will adjust the size automatically to the paper size you set.

- 1 Press  (**COPY**).
- 2 Load your document.
- 3 Enter the number of copies you want.
- 4 Press ◀ or ▶ to display Enlarge/Reduce.
- 5 Press Enlarge/Reduce.
- 6 Press 100%, Enlarge, Reduce, Fit to Page or Custom(25-400%).
- 7 Do one of the following:
 - If you chose Enlarge or Reduce, press the enlargement or reduction ratio you want.
 - If you chose Custom(25-400%), enter an enlargement or reduction ratio from 25% to 400%.
Press OK.
 - If you chose 100% or Fit to Page, go to step 8.

198% 4"x6"→A4
186% 4"x6"→LTR
104% EXE→LTR
100%
97% LTR→A4
93% A4→LTR
85% LTR→EXE
83% LGL→A4
78% LGL→LTR
46% LTR→4"x6"
Fit to Page
Custom(25-400%)

- 8 If you do not want to change additional settings, press **Black Start** or **Color Start**.



Note

- Page Layout is not available with Enlarge/Reduce.
- Page Layout, Book Copy, Sort, Thin Paper Copy, Duplex Copy and Watermark Copy are not available with Fit to Page.
- Fit to Page does not work properly when the document on the scanner glass is skewed more than 3 degrees. Using the document guidelines on the left and top, place your document in the upper left hand corner, with the document face down on the scanner glass.
- Fit to Page is not available from the ADF.
- Fit to Page is not available for Legal sized documents.

Making N in 1 copies or a poster (Page Layout)

The N in 1 copy feature can help you save paper by letting you copy two or four pages onto one printed page.

You can also produce a poster. When you use the poster feature your machine divides your document into sections, then enlarges the sections so you can assemble them into a poster. If you want to print a poster, use the scanner glass.

! IMPORTANT

- Make sure the paper size is set to Letter, A4 or Executive.
- Poster copy is not available for Executive size paper.
- If you are producing multiple color copies, N in 1 copy is not available.
- (P) means Portrait and (L) means Landscape.
- Poster copy is not available when using transparencies.

Note

- Watermark Copy, Book Copy, Sort, Thin Paper Copy, Ink Save Mode and Enlarge/Reduce are not available with Page Layout.
- Duplex Copy is not available with Poster copy.

- 1 Press  (COPY).
- 2 Load your document.
- 3 Enter the number of copies you want.
- 4 Press ◀ or ▶ to display Page Layout.
- 5 Press Page Layout.

- 6 Press ◀ or ▶ to display Off (1in1), 2in1 (P), 2in1 (L), 4in1 (P), 4in1 (L), Poster (2x1), Poster (2x2), Poster (3x3) or 2in1 (ID)¹.

¹ For details about 2 in 1 (ID), see *2 in 1 ID Copy* >> page 39.

- 7 If you do not want to change additional settings, press **Black Start** or **Color Start** to scan the page. If you placed the document in the ADF or are making a poster, the machine scans the pages and starts printing.

If you are using the scanner glass, go to step 8.

- 8 After the machine scans the page, press Yes to scan the next page.
- 9 Place the next page on the scanner glass. Press **Black Start** or **Color Start** to scan the document. Repeat steps 8 and 9 for each page of the layout.
- 10 After all the pages have been scanned, press No to finish.

Place the document face down in the direction shown below:

■ 2in1 (P)



■ 2in1 (L)

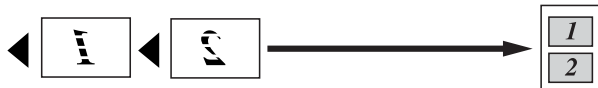

■ 4in1 (P)



■ 4in1 (L)



■ Poster (2x1)

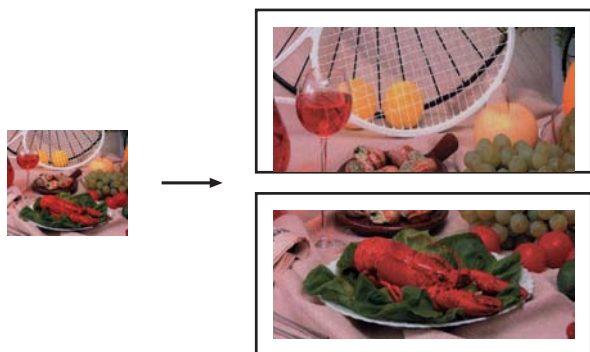

■ Poster (2x2)

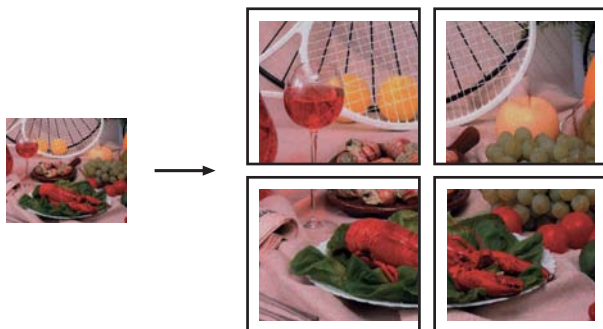

■ Poster (3x3)

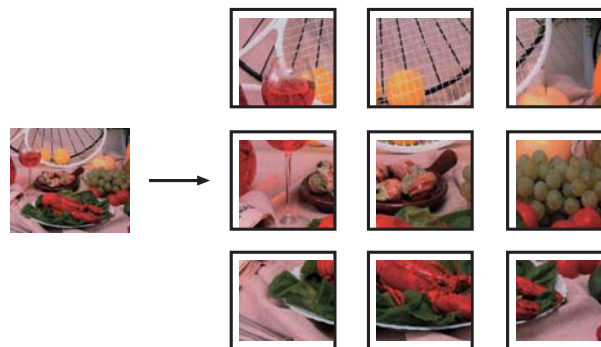

2 in 1 ID Copy

You can copy both sides of your identification card onto one page, keeping the original card size. Make sure the paper size is set to Letter or A4.

 **Note**

You can copy an identification card to the extent permitted under applicable laws. (▶▶Product Safety Guide: *Legal limitations for copying*)

- 1 Press  (COPY).
- 2 Place your identification card face down at the left corner of the scanner glass.

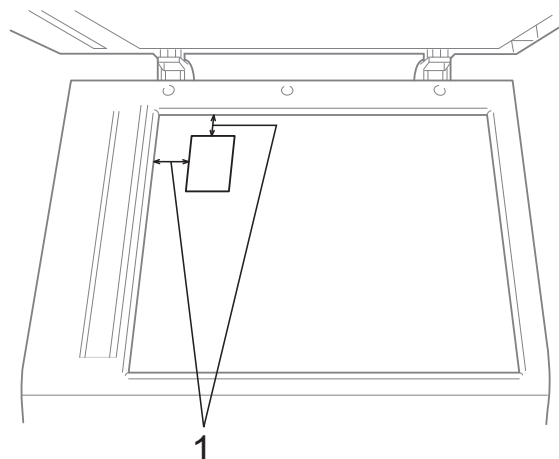

1 0.12 in. (3 mm) or greater (top, left)

- 3 Enter the number of copies you want.
- 4 Press ◀ or ▶ to display Page Layout.

- 5 Press **Page Layout**.
- 6 Press ◀ or ▶ to display **2in1 (ID)**.
- 7 Press **2in1 (ID)**.
- 8 Press **Black Start** or **Color Start**.
The machine starts scanning the first page.
- 9 After the machine has scanned one side, press **Yes**. Turn over the identification card and press **Black Start** or **Color Start** to scan the other side.



Note

- Watermark Copy, Book Copy, Sort, Duplex Copy, Thin Paper Copy, Ink Save Mode and Enlarge/Reduce are not available with **2in1 (ID)**.
- If you are producing multiple color copies, **2 in 1 (ID)** copy is not available.

Sorting copies using the ADF

You can sort multiple copies. Pages will be stacked in the order 321, 321, 321, and so on.

- 1 Press  (**COPY**).
- 2 Load your document.
- 3 Enter the number of copies you want.
- 4 Press ◀ or ▶ to display **Stack/Sort**.
- 5 Press **Stack/Sort**.
- 6 Press **Sort**.
- 7 If you do not want to change additional settings, press **Black Start** or **Color Start**.



Note

Fit to Page, **Page Layout** and **Book Copy** are not available with **Sort**.

Adjusting Density

You can adjust the copy density to make copies darker or lighter.

- 1 Press  (**COPY**).
- 2 Load your document.
- 3 Enter the number of copies you want.
- 4 Press ◀ or ▶ to display **Density**.
- 5 Press **Density**.
- 6 Press ▶ to make the copy darker or press ◀ to make the copy lighter. Press **OK**.
- 7 If you do not want to change additional settings, press **Black Start** or **Color Start**.

Ink Save Mode

Ink Save Mode can help you save some ink. Your machine detects the edges of the image and prints the outline of the image.

The amount of ink saved will vary depending on the document.

Ink Save Mode: Off



Ink Save Mode: On

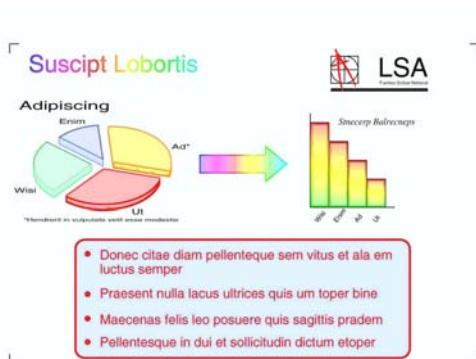

- 1 Press  (COPY).
- 2 Load your document.
- 3 Enter the number of copies you want.
- 4 Press ◀ or ▶ to display Advanced Settings.
- 5 Press Advanced Settings.
- 6 Press Ink Save Mode.

- 7 If you do not want to change any additional settings, press **Black Start** or **Color Start**.

Note

- Watermark Copy, Book Copy, Thin Paper Copy and Page Layout are not available with Ink Save Mode.
- Ink Save Mode may make your printouts look different from your original document.

Thin Paper Copy

If your document is a duplex copy on thin paper, choose Thin Paper Copy so the print on the other side does not bleed through.

- 1 Press  (COPY).
- 2 Load your document.
- 3 Enter the number of copies you want.
- 4 Press ◀ or ▶ to display Advanced Settings.
- 5 Press Advanced Settings.
- 6 Press Thin Paper Copy.
- 7 Press **Black Start** or **Color Start**.

Note

Fit to Page, Page Layout, Ink Save Mode, Book Copy and Watermark Copy are not available with Thin Paper Copy.

Book Copy

Book copy corrects dark borders and skew when copying from the scanner glass. Your machine can correct the data automatically.

- 1 Press  (**COPY**).
- 2 Load your document.
- 3 Enter the number of copies you want.
- 4 Press ◀ or ▶ to display Advanced Settings.
- 5 Press Advanced Settings.
- 6 Press Book Copy.
- 7 If you do not want to change additional settings, press **Black Start** or **Color Start**.



Note

Page Layout, Sort, Duplex Copy, Ink Save Mode, Fit to Page, Thin Paper Copy and Watermark Copy are not available with Book Copy.

Watermark Copy

You can place a logo or text into your document as a Watermark. You can select one of the template watermarks, data from your media cards or USB Flash memory drive, or scanned data.



Note

Fit to Page, Page Layout, Thin Paper Copy, Ink Save Mode and Book Copy are not available with Watermark Copy.

Using a template

- 1 Press  (**COPY**).
- 2 Load your document.
- 3 Enter the number of copies you want.
- 4 Press ◀ or ▶ to display Advanced Settings.
- 5 Press Advanced Settings.
- 6 Press Watermark Copy.
- 7 Press Edit Template.
- 8 Change the settings by pressing the options displayed on the Touchscreen if required.
Press OK.
- 9 Press OK to confirm to use watermark.
- 10 If you do not want to change additional settings, press **Black Start** or **Color Start**.

Using a media card or USB Flash memory drive

- 1 Press  (**COPY**).
- 2 Load your document.
- 3 Enter the number of copies you want.
- 4 Press ◀ or ▶ to display Advanced Settings.
- 5 Press Advanced Settings.
- 6 Press Watermark Copy.
- 7 Press Use Image.
- 8 Insert a media card or USB Flash memory drive. Press Media.
- 9 Press the data you want to use for the watermark.
- 10 Change any additional settings from the options shown on the LCD. Press OK.
- 11 Press OK to confirm to use watermark.
- 12 If you do not want to change additional settings, press **Black Start** or **Color Start**.

IMPORTANT

DO NOT take out the memory card or USB Flash memory drive while the status LED is blinking to avoid damaging the card, USB Flash memory drive, or the data stored on them.

Using a scanned paper document as your watermark

- 1 Press  (**COPY**).
- 2 Enter the number of copies you want.
- 3 Press ◀ or ▶ to display Advanced Settings.
- 4 Press Advanced Settings.
- 5 Press Watermark Copy.
- 6 Press Use Image.
- 7 Press Scan. Place the page that you want to use as a watermark on the scanner glass.
- 8 Press **Black Start** or **Color Start**.
- 9 Take out the watermark document you scanned and load the document you want to copy.
- 10 Press Transparency, and then press ◀ or ▶ to change the Transparency of the watermark. Press OK.
- 11 Press OK.
- 12 Press OK to confirm to use the watermark.
- 13 If you do not want to change any additional settings, press **Black Start** or **Color Start**.



Note

You cannot enlarge or reduce the scanned watermark.

Duplex (2-sided) copying

You can reduce the amount of paper used for copies by copying on both sides of the paper.

We recommend you load your document in the ADF for duplex copying. For 2-sided documents and books use the scanner glass.

(long edge flip)

Portrait

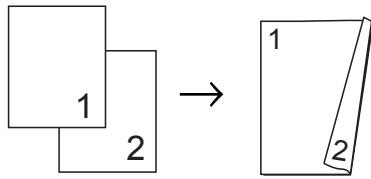

Landscape

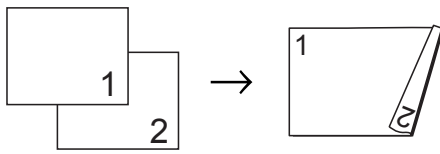

(short edge flip)

Portrait

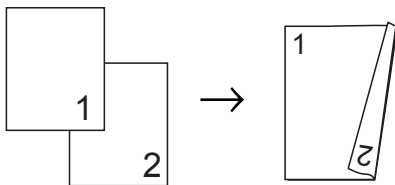

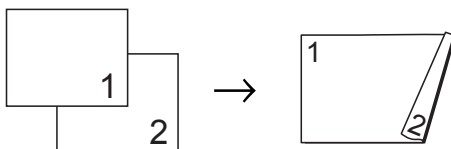

Landscape



Note

- 2in1 (ID), Poster, Fit to Page and Book Copy are not available with Duplex Copy.
- You can only use plain paper sizes Letter, A4, A5 or Executive.

- 1 Press  (COPY).
- 2 Press ◀ or ▶ to display Duplex Copy.
- 3 Press Duplex Copy.
- 4 Press On to turn on the duplex settings.
- 5 Press Portrait LongEdgeFlip, Landscape LongEdgeFlip, Portrait ShortEdgeFlip or Landscape ShortEdgeFlip.
- 6 Press  after reading the message on the LCD.
- 7 Load your document.
- 8 Enter the number of copies you want.



Note

If you want to sort multiple copies, press ◀ or ▶ to display Stack/Sort, then press Sort.

- 9 Press **Black Start** or **Color Start**.
If you placed the document in the ADF, the machine scans the pages and starts printing.

If you are using the scanner glass, go to step 10.
- 10 The LCD shows:

Turn over the document (or Flip the book), then press Scan. When you finish, press Complete.

Place the next page on the scanner glass and press Scan. Press **Black Start** or **Color Start**.
The machine starts printing.
- 11 If you pressed Sort for multiple copies, repeat step 10 for each additional page. After all the pages have been scanned, press Complete.
The machine starts printing.

DO NOT touch the printed page until it is ejected the second time. The machine will print the first side and eject the paper and then pull the paper in to print the second side.

Note

If you get a paper jam, press **Advanced** after step 4, and then press one of the jam prevention settings: **Duplex1** or **Duplex2**.

Duplex1 uses a longer print time for the ink to dry.

Duplex2 uses a longer print time and will also print in lighter colors.

Setting your favorites

You can store the copy settings that you use most often by setting them as a favorite. You can set up to three favorites.

- 1 Press  (**COPY**).
- 2 Choose the copy option and settings you want to store.
- 3 Press ◀ or ▶ to display **Favorite Settings**.
- 4 Press **Favorite Settings**.
- 5 Press **Store**.

Note

Set **Watermark Copy** to **Off** or **Template** when storing **Favorite Settings**.

- 6 Press the location where you want to store your settings for **Favorite:1**, **Favorite:2** or **Favorite:3**.

- 7 Do one of the following:
 - If you want to rename your setting, press  to delete characters. Then enter the new name (up to 12 characters).
(▶▶Basic User's Guide: *Entering Text*)
Press **OK**.
 - If you do not want to rename your setting, press **OK**.

Retrieving your favorite setting

When you are ready to use one of your favorite set of settings, you can recall it.

- 1 Press  (**COPY**).
- 2 Press ◀ or ▶ to display **Favorite**.
- 3 Press **Favorite**.
- 4 Press the favorite setting you want to retrieve.

Rename your favorite setting

After you stored your favorite setting, you can rename it.

- 1 Press  (**COPY**).
- 2 Press ◀ or ▶ to display **Favorite Settings**.
- 3 Press **Favorite Settings**.
- 4 Press **Rename**.
- 5 Press the favorite setting you want to rename.
- 6 Enter the new name (up to 12 characters). (▶▶Basic User's Guide: *Entering Text*)
- 7 Press **OK**.

PhotoCapture Center™: Printing photos from a memory card or USB Flash memory drive

PhotoCapture Center™ operations

Memory cards, USB Flash memory drive and folder structures

Your machine is designed to be compatible with modern digital camera image files, memory cards and USB Flash memory drives; however, please read the points below to avoid errors:

- The image file extension must be .JPG (other image file extensions like .JPEG, .TIF, .GIF and so on will not be recognized).
- Direct PhotoCapture Center™ printing must be performed separately from PhotoCapture Center™ operations using the PC. (Simultaneous operation is not available.)
- The machine can read up to 999 files ¹ on a memory card or USB Flash memory drive.

¹ The folder inside memory cards or USB Flash memory drive is also counted.
- The DPOF file on the memory cards must be in a valid DPOF format. (See *DPOF printing* >> page 50.)

Please be aware of the following:

- When printing an index or image, the PhotoCapture Center™ will print all valid images, even if one or more images have been corrupted. Corrupted images will not be printed.

- (memory card users)

Your machine is designed to read memory cards that have been formatted by a digital camera.

When a digital camera formats a memory card it creates a special folder into which it copies image data. If you need to modify the image data stored on a memory card with your PC, we recommend that you do not modify the folder structure created by the digital camera. When saving new or modified image files to the memory card, we also recommend you use the same folder your digital camera uses. If the data is not saved to the same folder, the machine may not be able to read the file or print the image.

- (USB Flash memory drive users)

This machine supports USB Flash memory drives that have been formatted by Windows®.

Movie printing

You can print images from movie files that are stored on a memory card or USB Flash memory drive.

A movie file is automatically divided into 9 parts by movie recording times and is placed in 3 lines, then you can see and print the scenes that have been automatically divided.

Note

- You cannot choose a particular movie scene.
- You can use AVI or MOV movie file formats (Motion JPEG only). However, if an AVI file size is 1 GB or more (the shooting time is about 30 minutes) or a MOV file size is 2 GB or more (the shooting time is about 60 minutes), these files cannot be printed.

Print Images

Print Index (Thumbnails)

The PhotoCapture Center™ assigns numbers for images (such as No.1, No.2, No.3, and so on).



→ NO.1
DEI.JPG 01.01.2009
100KB

The PhotoCapture Center™ does not recognize any other numbers or file names that your digital camera or computer has used to identify the pictures. You can print a thumbnail page. This will show all the pictures on the memory card or USB Flash memory drive.

Note

Only file names that are 20 characters or less will be printed correctly on the index sheet.

- 1 Make sure you have put the memory card or USB Flash memory drive in the proper slot.

Press  (PHOTO).

- 2 Press Index Print.
- 3 Press Index Sheet and choose 6 Images/Line or 5 Images/Line.

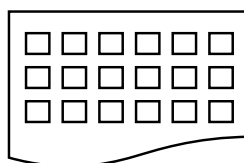

6 Images/Line

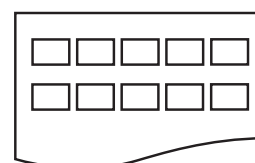

5 Images/Line

Print time for 5 Images/Line will be slower than 6 Images/Line, but the quality is better.

- 4 Do one of the following:
 - Press `Print Settings` to change the paper type or the paper size you are using.
 - If you do not want to change the paper settings, go to 7.
- 5 Press `Paper Type`. Choose the paper type you are using, Plain Paper, Inkjet Paper, Brother BP71, Brother BP61 or Other Glossy.
- 6 Press `Paper Size`. Choose the paper size you are using, Letter or A4.
- 7 Press **Color Start** to print.

Printing Photos

Before you can print an individual image, you have to know the image number.

- 1 Make sure you have put the memory card or USB Flash memory drive in the proper slot.
Press  (**PHOTO**).
- 2 Print the Index. (See *Print Index (Thumbnails)* >> page 47.)
- 3 Press `Index Print`.
- 4 Press `Print Photos`.
- 5 Enter the image number that you want to print from the Index page (Thumbnails). After you have chosen the image numbers, press **OK**.



Note

- You can enter multiple numbers at one time by using a comma or a hyphen. For example, enter 1,3,6 to print images No.1, No.3 and No.6. Enter 1-5 to print images No.1 to No.5.
- You can enter up to 12 characters (including commas) for the image numbers you want to print.

6

Enter the number of copies you want either by pressing the number box directly and entering the number you want or by pressing **+** or **-**.

7

Do one of the following:

- Press `Print Settings` to change the print settings. (See page 51.)
- If you do not want to change any settings, press **Color Start** to print.

Enhance Photos

You can edit and add effects to your photos and view them on the LCD before printing.



Note

The `Enhance Photo` feature is supported by technology from Reallusion, Inc.  **REALLUSION**

1

Make sure you have put a memory card or USB Flash memory drive in the proper slot.

Press  (**PHOTO**).

2

Press `Enhance Photo`.





 **Note**







- Four thumbnails are displayed at a time with the current page number and total number of pages listed under the thumbnails.
- Press ◀ or ▶ repeatedly to scroll through all photos. Hold down ◀ or ▶ to fast-forward and fast-rewind through the thumbnail pages.
- Press  to start Slide Show.







- 3 Press a photo from the thumbnails.
- 4 Press **Enhance** or **Trim**. You can also choose both together. Press **OK**.
- 5 Do one of the following:
 - If you chose **Enhance**, go to step 6.
 - If you chose **Trim**, go to step 7.
- 6 Press the effect you wish to add. Press **OK**. Go to step 8.

 **Note**

- You have 10 ways to add effects to your photo.

	(Auto Correct) The machine decides the suitable effect for your photo.
	(Enhance Skin) Best used for adjusting portrait photographs. It adjusts human skin color. Press ◀ or ▶ to adjust the level of contrast.
	(Enhance Scenery) Best used for adjusting landscape photographs. It highlights green and blue areas in your photo. Press ◀ or ▶ to adjust the level of contrast.
	(Remove Red-Eye) The machine will attempt to remove red-eye from your photo. If red-eye detection fails, you can press the Try Again button to re-detect.

	(Night Scene) Night Scene is best used for adjusting night view photographs to make them more vivid. Press ◀ or ▶ to adjust the level of contrast.
	(Fill Light) Fill Light is best used for adjusting photographs against the light. Press ◀ or ▶ to adjust the level of contrast.
	(Whiteboard) Whiteboard is best used for adjusting photographs. It detects letters on a whiteboard in your photo and makes them more legible.
	(Monochrome) You can convert your photo to black & white.
	(Sepia) You can convert the color of your photo to sepia.
	(Auto Correct & Remove Red-Eye) The machine decides the suitable effects for your photo. Also, it will attempt to remove red-eye from your photo.

- There are some cases when red-eye may not be removed.
 - When the face is too small in the image.
 - When the face is turning too far up, down, left or right.
- After adding each effect, you can enlarge the view of the image by pressing . To go back to the original size, press .
- While the image is enlarged, you can move around the image with **up** () , **down** () , **left** () and **right** () .
- Press **Cancel** to return to the list of effects.
- If your photo is very small or has irregular proportions you may not be able to trim or enhance the photo. The LCD will display **Image Too Small.** or **Image Too Long.**

- 7 Adjust the red frame around your photo. The part inside of the red frame will be printed.

- Press **+** or **-** to enlarge or reduce the frame size.
- Press **▲**, **▼**, **◀** or **▶** to move the position of the frame.
- Press  to rotate the frame.

Press **OK** when you have finished adjusting the frame setting.
Press **OK** to confirm.



Note

If your photo is very small or has irregular proportions you may not be able to trim or enhance the photo. The LCD will display `Image Too Small.` or `Image Too Long.`

- 8 Enter the number of copies you want either by pressing the number box directly and entering the number you want or by pressing **+** or **-**.
Press **OK**.
- 9 Do one of the following.
- Press **Print Settings** to change the print settings. (See page 51.)
 - If you do not want to change any settings, press **Color Start** to print.

DPOF printing

DPOF stands for Digital Print Order Format.

Major digital camera manufacturers (Canon Inc., Eastman Kodak Company, FUJIFILM Corporation, Panasonic Corporation and Sony Corporation) created this standard to make it easier to print images from a digital camera.

If your digital camera supports DPOF printing, you will be able to choose on the digital camera display the images and number of copies you want to print.

When a memory card (Memory Stick™, Memory Stick PRO™, Memory Stick Duo™, Memory Stick PRO Duo™, SD, SDHC or SDXC) containing DPOF information is put into your machine, you can print the chosen image easily.

- 1 Make sure you have put the memory card in the proper slot.
Press  (**PHOTO**).
The machine will ask you if you want to use DPOF settings.
- 2 Press **Yes**.
- 3 Do one of the following:
 - Press **Print Settings** to change the print settings. (See page 51.)
 - If you do not want to change any settings, press **Color Start** to print.



Note

An Invalid DPOF File error can occur if the print order that was created on the camera has been corrupted. Delete and recreate the print order using your camera to correct this problem. For instructions on how to delete or recreate the print order, refer to your camera manufacturer's support Web site or accompanying documentation.

PhotoCapture Center™ print settings

You can change the print settings for the next printing.

These settings are temporary, and the machine returns to its default settings 3 minutes after printing, unless you have set the Mode Timer to 2 minutes or less. (See *Mode Timer* >> page 4.)



Note

You can save the print settings you use most often by setting them as the default. (See *Setting your changes as the new default* >> page 54.)



Print Quality

- 1 Press Print Settings.
- 2 Press ▲ or ▼ to display Print Quality.
- 3 Press Print Quality.
- 4 Press Normal or Photo.
- 5 If you do not want to change additional settings, press . Press **Color Start** to print.

Paper options



Paper Type

- 1 Press Print Settings.
- 2 Press ▲ or ▼ to display Paper Type.
- 3 Press Paper Type.
- 4 Press the paper type you are using, Plain Paper, Inkjet Paper, Brother BP71, Brother BP61 or Other Glossy.
- 5 If you do not want to change additional settings, press . Press **Color Start** to print.

Paper and print size

- 1 Press Print Settings.
- 2 Press ▲ or ▼ to display Paper Size.
- 3 Press Paper Size.
- 4 Press the paper size you are using, 4"x6", 5"x7", Letter or A4. Do one of the following:
 - If you chose Letter or A4, go to step 5.
 - If you chose another size of paper, go to step 6.

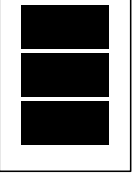
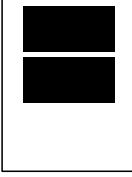
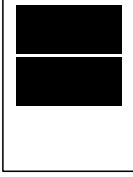
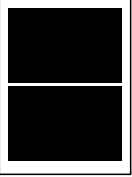
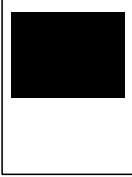
5 Press the Print Size.

Example: Printed position for Letter paper		
1 3"x4"	2 3.5"x5"	3 4"x6"
		
4 5"x7"	5 6"x8"	6 Max. Size
		

- 6 If you do not want to change additional settings, press . Press **Color Start** to print.

Adjusting Brightness, Contrast and Color

Brightness

- 1 Press **Print Settings**.
- 2 Press **▲** or **▼** to display **Brightness**.
- 3 Press **Brightness**.
- 4 Press **◀** to make a darker print or press **▶** to make a lighter print. Press **OK**.
- 5 If you do not want to change additional settings, press . Press **Color Start** to print.

Contrast

You can choose the contrast setting. Increasing the contrast will make an image look sharper and more vivid.

- 1 Press **Print Settings**.
- 2 Press **▲** or **▼** to display **Contrast**.
- 3 Press **Contrast**.
- 4 Press **▶** to increase the contrast or press **◀** to decrease the contrast. Press **OK**.
- 5 If you do not want to change additional settings, press . Press **Color Start** to print.

Color Enhancement (True2Life™)

You can turn on the color enhancement (True2Life™) feature to print more vivid images. Printing time will be slower.

- 1 Press **Print Settings**.
- 2 Press **▲** or **▼** to display **True2Life**.
- 3 Press **True2Life**.
- 4 Do one of the following:
 - If you want to customize the **White Balance**, **Sharpness** or **Color Density**, press **On**, and then go to step 5.
 - If you do not want to customize, press **Off**. Go to step 8.
- 5 Press **White Balance**, **Sharpness** or **Color Density**.
- 6 Press **◀** or **▶** to adjust the degree of the setting. Press **OK**.

- 7** Do one of the following:
- If you want to customize another color enhancement, repeat steps **5** to **6**.
 - If you want to change other settings, press  to display the print setting menu and press the setting you want to change. (See page 51.)

- 8** If you do not want to change additional settings, press . Press **Color Start** to print.



Note

• **White Balance**

This setting adjusts the hue of the white areas of an image. Lighting, camera settings and other influences will affect the appearance of white. The white areas of a picture may be slightly pink, yellow or some other color. By using this setting, you can correct that effect and bring the white areas back to pure white.

• **Sharpness**

This setting enhances the detail of an image, similar to adjusting the fine focus on a camera. If the image is not in true focus and you cannot see the fine details of the picture, then adjust the sharpness.

• **Color Density**

This setting adjusts the total amount of color in the image. You can increase or decrease the amount of color in an image to improve a washed out or weak picture.

Cropping

If your photo is too long or wide to fit the available space on your chosen layout, part of the image will automatically be cropped.

The factory setting is **On**. If you want to print the whole image, turn this setting to **Off**. When you set **Cropping** to **Off**, also set **Borderless** to **Off**. (See *Borderless printing* >> page 54.)

- 1** Press **Print Settings**.
- 2** Press **▲** or **▼** to display **Cropping**.
- 3** Press **Cropping**.
- 4** Press **Off** (or **On**).
- 5** If you do not want to change additional settings, press . Press **Color Start** to print.

Cropping: On

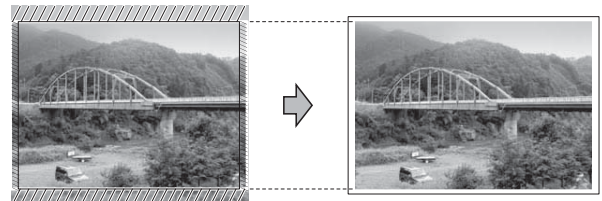

Cropping: Off

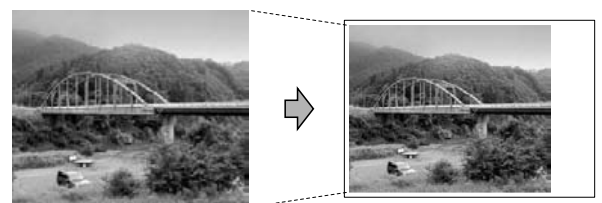

Borderless printing

This feature expands the printable area to the edges of the paper. Printing time will be slightly slower.

- 1 Press `Print Settings`.
- 2 Press `▲` or `▼` to display `Borderless`.
- 3 Press `Borderless`.
- 4 Press `Off` (or `On`).
- 5 If you do not want to change additional settings, press . Press **Color Start** to print.

Print Date

You can print the date if it is already in the data on your photo. The date will be printed on the lower right corner. If the data doesn't have the date information, you cannot use this function.

- 1 Press `Print Settings`.
- 2 Press `▲` or `▼` to display `Print Date`.
- 3 Press `Print Date`.
- 4 Press `On` (or `Off`).
- 5 If you do not want to change additional settings, press . Press **Color Start** to print.



Note

The DPOF setting on your camera must be turned off to use the `Print Date` feature.

Setting your changes as the new default

You can save the print settings you use most often by setting them as the default settings. These settings will stay until you change them again.

- 1 Press your new setting. Repeat this step for each setting you want to change.
- 2 After changing the last setting, press `▲` or `▼` to choose `Set New Default`.
- 3 Press `Set New Default`.
- 4 Press `Yes` to confirm.
- 5 Press **Stop/Exit**.

Restoring all settings to the factory settings

You can restore the PhotoCapture settings `Print Quality`, `Paper Type`, `Paper Size`, `Brightness`, `Contrast`, `True2Life`, `Cropping`, `Borderless` and `Print Date`, that you have changed, to the factory settings.

- 1 Press `Print Settings`.
- 2 Press `▲` or `▼` to display `Factory Reset`.
- 3 Press `Factory Reset`.
- 4 Press `Yes` to confirm.
- 5 Press **Stop/Exit**.

Scan to a memory card or USB Flash memory drive

Auto Crop

You can scan multiple documents placed on the scanner glass. An individual document can be previewed on the LCD before you save it. When you choose *Auto Crop*, the machine will scan each document and create separate files. For example, if you place three documents on the scanner glass, the machine will scan and create three separate files. If you want to create a three-page file, choose *PDF* or *TIFF* for *File Type*.

(If you choose *JPEG*, each document is created as three separate files.)

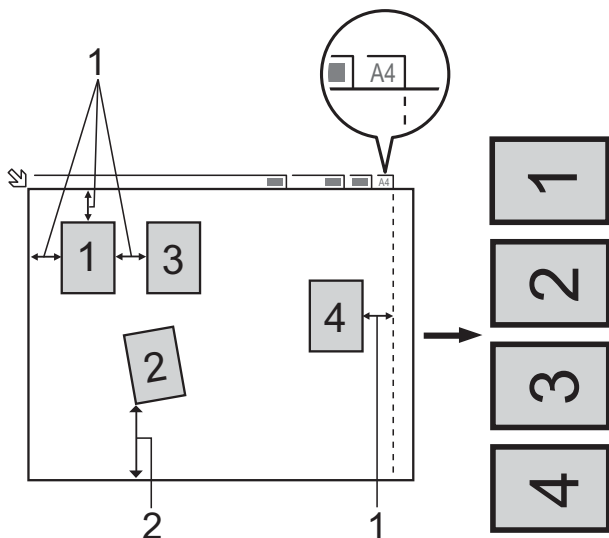

- 1 0.4 in. (10 mm) or greater (top, left, right)
- 2 0.8 in. (20 mm) or greater (bottom)

Note

Auto Crop is supported by technology from Reallusion, Inc.



- 1 Make sure you have put the memory card or USB Flash memory drive in the proper slot.
- 2 Load your document.
- 3 Press (**SCAN**).
- 4 Press ◀ or ▶ to display *to Media*.
- 5 Press *to Media*.
- 6 Press ◀ or ▶ to display *Auto Crop*.
- 7 Press *Auto Crop*.
- 8 Press *On*.
- 9 If you do not want to change additional settings, press **Black Start** or **Color Start** to start scanning.
- 10 The number of the scanned documents appears on the LCD. Press *OK*.
- 11 Press ◀ or ▶ to preview each document data.
- 12 Press *Save All* to save the data.

Note

- `Auto Crop` is available for paper with right angles of 90 degrees at all four corners. If one of the angles is not square, `Auto Crop` cannot detect the document.
- If your document is too long or wide, this setting does not work properly.
- You must place the documents away from the edges of the scanner glass as shown in the illustration.
- You must place the documents at least 0.4 in. (10 mm) apart from each other.
- `Auto Crop` adjusts the skew of the document on the scanner glass, but if your document is skewed more than 10 degrees, this setting will not work.
- The ADF must be empty to use the `Auto Crop`.
- The `Auto Crop` feature is available for up to a maximum of 16 documents depending on the size of your documents.

IMPORTANT

DO NOT take out the memory card or USB Flash memory drive while the status LED is blinking to avoid damaging the card, USB Flash memory drive or the data stored on them.

How to set a new default

You can save the Scan to Media settings (Quality, File Type and Auto Crop) you use most often by setting them as the default settings. These settings will stay until you change them again.

- 1 Press  (**SCAN**).
- 2 Press ◀ or ▶ to display `to Media`.
- 3 Press `to Media`.
- 4 Press ◀ or ▶ to display `Set New Default`.
- 5 Press `Set New Default`.
- 6 Press `Yes` to confirm.
- 7 Press **Stop/Exit**.

How to reset to the factory settings

You can restore all the Scan to Media settings (Quality, File Type and Auto Crop), that you have changed, to the factory settings.

- 1 Press  (**SCAN**).
- 2 Press ◀ or ▶ to display `to Media`.
- 3 Press `to Media`.
- 4 Press ◀ or ▶ to choose `Factory Reset`.
- 5 Press `Factory Reset`.
- 6 Press `Yes` to confirm.
- 7 Press **Stop/Exit**.

Printing photos directly from a PictBridge camera



Your Brother machine supports the PictBridge standard, allowing you to connect to and print photos directly from any PictBridge compatible digital camera.

If your camera is using the USB Mass Storage standard, you can also print photos from a digital camera without PictBridge. (See *Printing photos directly from a digital camera (without PictBridge)* ►► page 60.)

PictBridge requirements

To avoid errors, remember the following points:

- The machine and the digital camera must be connected using a suitable USB cable.
- The image file extension must be .JPG (other image file extensions like .JPEG, .TIF, .GIF and so on will not be recognized).
- PhotoCapture Center™ operations are not available when using the PictBridge feature.

Setting your digital camera

Make sure your camera is in PictBridge mode. The following PictBridge settings may be available from the LCD of your PictBridge compatible camera.

Depending on your camera some of these settings may not be available.

Camera Menu Selections	Options
Paper Size	Letter, A4, 4" × 6", Printer Settings (Default setting) ²
Paper Type	Plain Paper, Glossy Paper, Inkjet Paper, Printer Settings (Default setting) ²
Layout	Borderless: On, Borderless: Off, Printer Settings (Default setting) ²
DPOF setting ¹	-
Print Quality	Normal, Fine, Printer Settings (Default setting) ²
Color Enhancement	On, Off, Printer Settings (Default setting) ²
Print Date	On, Off, Printer Settings (Default setting) ²

¹ See *DPOF printing* >> page 59 for more details.

² If your camera is set to use the Printer Settings (Default setting), the machine will print your photo using the following settings.

Settings	Options
Paper Size	4" × 6"
Paper Type	Glossy Paper
Layout	Borderless: On
Print Quality	Fine
Color Enhancement	Off
Print Date	Off

- When your camera does not have any menu selections, these settings are also used.
- The name and availability of each setting depends on the specification of your camera.

Please refer to the documentation supplied with your camera for more detailed information on changing PictBridge settings.

Printing Images



Note

Remove any memory cards or USB Flash memory drive from the machine before connecting a digital camera.

- 1 Make sure that your camera is turned off. Connect your camera to the USB direct interface (1) on the machine using the USB cable.

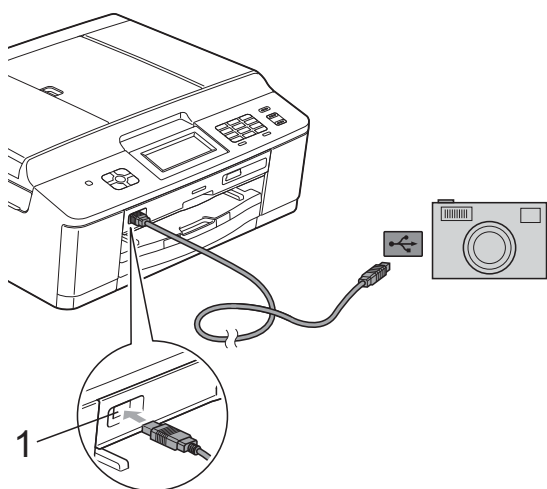

1 USB direct interface

- 2 Turn on the camera. When the machine has recognized the camera, the LCD shows `Camera Connected`.
- 3 Choose the photo you want to print following the instructions from your camera. When the machine starts printing a photo, the LCD will show `Printing`.

! IMPORTANT

To prevent damage to your machine, do not connect any device other than a digital camera or USB Flash memory drive to the USB direct interface.

DPOF printing

DPOF stands for Digital Print Order Format.

Major digital camera manufacturers (Canon Inc., Eastman Kodak Company, FUJIFILM Corporation, Panasonic Corporation and Sony Corporation) created this standard to make it easier to print images from a digital camera.

If your digital camera supports DPOF printing, you will be able to choose on the digital camera display the images and number of copies you want to print.



Note

An Invalid DPOF File error can occur if the print order that was created on the camera has been corrupted. Delete and recreate the print order using your camera to correct this problem. For instructions on how to delete or recreate the print order, refer to your camera manufacturer's support Web site or accompanying documentation.

Printing photos directly from a digital camera (without PictBridge)

If your camera is using the USB Mass Storage standard, you can connect your camera in storage mode. This enables you to print photos from your camera.

(If you would like to print photos in PictBridge mode, see *Printing photos directly from a PictBridge camera* >> page 57.)

Note

The name, availability and operation differ among digital cameras. Please refer to the documentation supplied with your camera for detailed information, such as how to switch from PictBridge mode to USB mass storage mode.

Printing Images

Note

Remove any memory cards or USB Flash memory drive from the machine before connecting a digital camera.

- 1 Make sure that your camera is turned off. Connect your camera to the USB direct interface (1) on the machine using the USB cable.

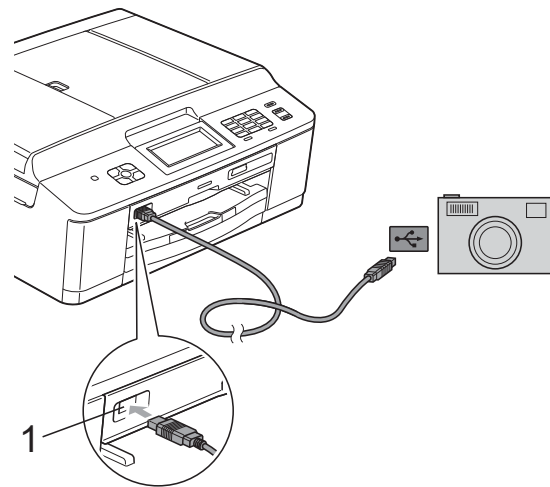

1 USB direct interface

- 2 Turn on the camera.
- 3 Follow the steps in *Print Images* >> page 47.

! IMPORTANT

To prevent damage to your machine, do not connect any device other than a digital camera or USB Flash memory drive to the USB direct interface.

A

Routine maintenance

Cleaning and checking the machine

Cleaning the outside of the machine

Clean the Touchscreen as follows:

! IMPORTANT

- Turn off the power switch when you clean the Touchscreen.
- DO NOT use any type of liquid cleaners (including ethanol).

- 1 Clean the Touchscreen with a *dry*, soft lint-free cloth.

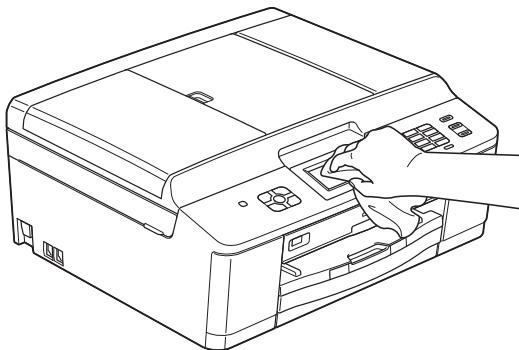

Clean the outside of the machine as follows:

! IMPORTANT

- Use neutral detergents. Cleaning with volatile liquids such as thinner or benzine will damage the outside surface of the machine.
- DO NOT use cleaning materials that contain ammonia.
- DO NOT use isopropyl alcohol to remove dirt from the control panel. It may crack the panel.

- 1 Pull the paper tray (1) completely out of the machine.

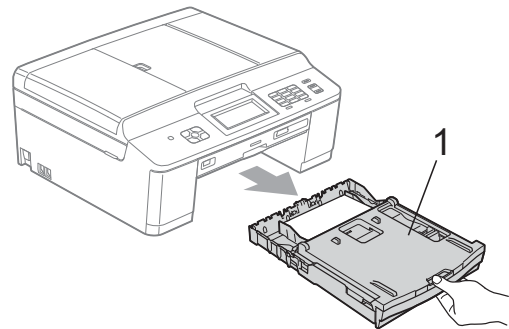

- 2 Wipe the outside of the machine with a *dry*, soft lint-free cloth to remove dust.

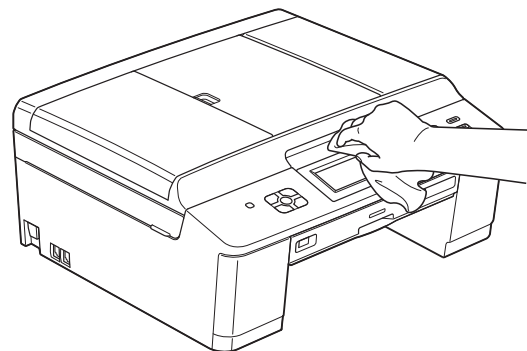

- 3 Lift the output paper tray cover and remove anything that is stuck inside the paper tray.

- 4 Wipe the inside and outside of the paper tray with a *dry*, soft lint-free cloth to remove dust.

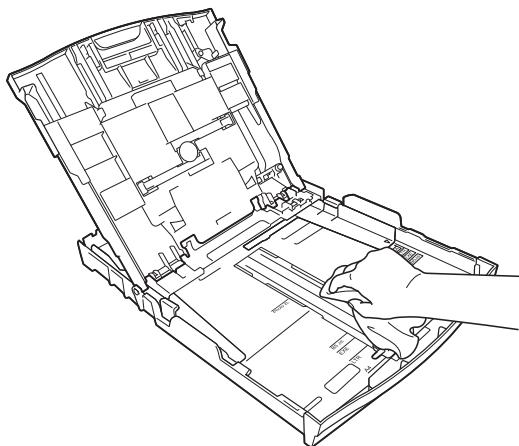

- 5 Close the output paper tray cover and put the paper tray firmly back in the machine.

Cleaning the machine's printer platen

WARNING



Be sure to unplug the machine from the AC power outlet before cleaning the printer platen to avoid an electrical shock.

- 1 Using both hands, grasp the plastic tabs on both side of the machine to lift the scanner cover into the open position.
- 2 Clean the machine's printer platen (1) and the area around it, wiping off any scattered ink with a *dry*, soft lint-free cloth.

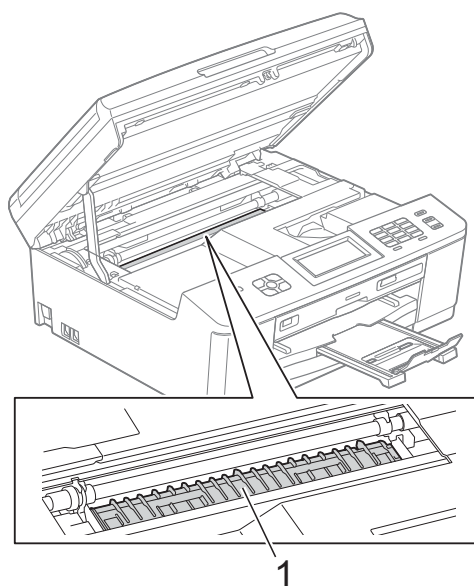

- 3 Using both hands, grasp the plastic tabs on both sides of the machine and gently close the scanner cover.
- 4 Re-connect the power cord.

Cleaning the paper feed rollers

If the paper feed rollers are stained with ink, it may cause paper feed problems.

- 1 Unplug the machine from the AC power outlet. Pull the paper tray (1) completely out of the machine.

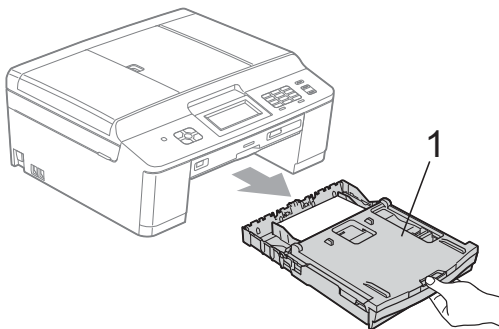

Note

If the paper support flap is open, close it, and then close the paper support.

- 2 Clean the front side of the Paper Feed Rollers (1) with a soft lint-free cloth moistened with water, using a side-to-side motion. After cleaning, wipe the rollers with a *dry*, soft lint-free cloth to remove all moisture.

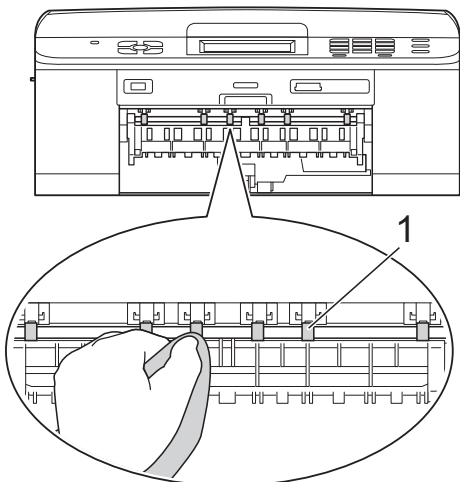

- 3 Lift the Jam Clear flap (2), and then clean the back side of the Paper Feed Rollers (1) with a soft lint-free cloth moistened with water. After cleaning, wipe the rollers with a *dry*, soft lint-free cloth to remove all moisture.

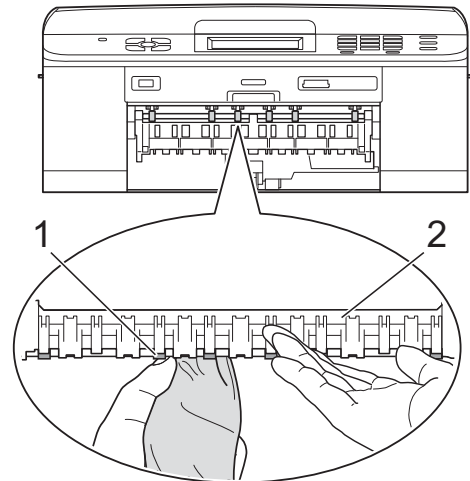

- 4 Put the paper tray firmly back in the machine.
- 5 Re-connect the power cord.



Note

Do not use the machine again until the rollers are dry. Using the machine before the rollers are dry may cause paper feed problems.

Cleaning the paper pick-up rollers

- 1 Unplug the machine from the AC power outlet.
- 2 Pull the paper tray completely out of the machine.

Note

If the machine starts to multi-feed the last few sheets of paper in the tray, clean the Base Pad (1) with a soft lint-free cloth moistened with water.

After cleaning, wipe the pad with a *dry*, soft lint-free cloth to remove all moisture.

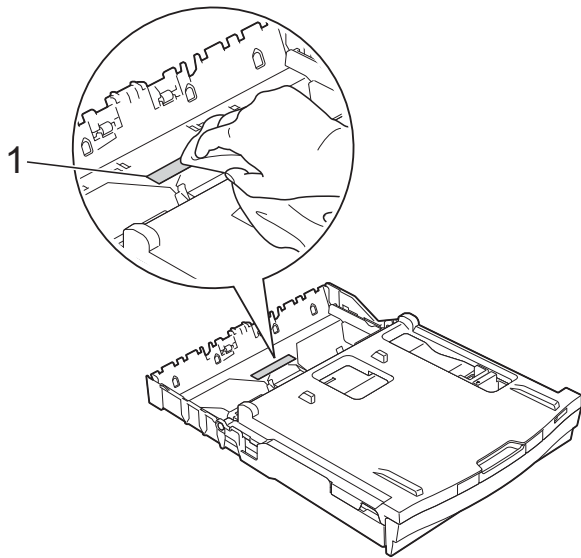

- 3 Open the Jam Clear Cover (1) at the back of the machine.

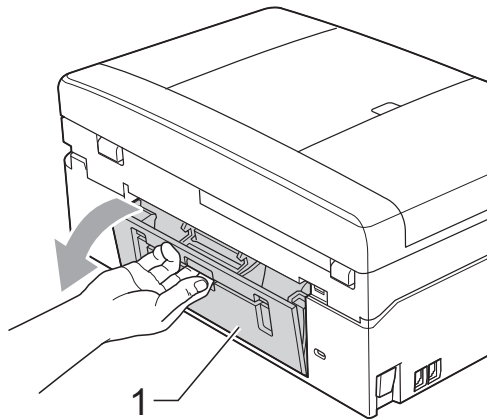

- 4 Clean the Paper Pick-up Rollers (1) with a soft lint-free cloth moistened with water. Slowly turn the rollers so that the whole surface is cleaned. After cleaning, wipe the rollers with a *dry*, soft lint-free cloth to remove all moisture.

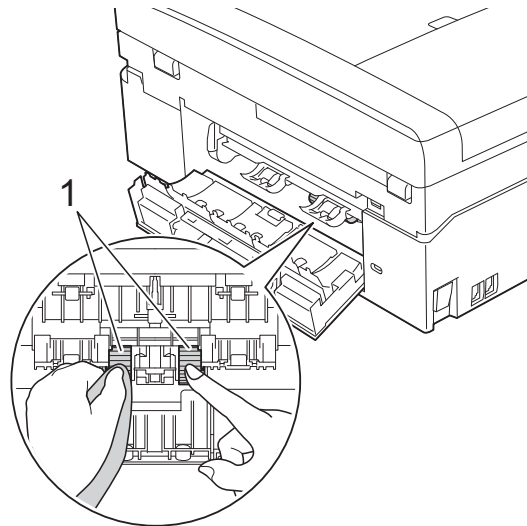

- 5 Close the Jam Clear Cover. Make sure the cover is closed completely.
- 6 Put the paper tray firmly back in the machine.
- 7 Re-connect the power cord.

Checking the ink volume

Although an ink volume icon appears on the LCD, you can use the ink menu to see a large graph showing the ink that is left in each cartridge.

- 1 Press .
- 2 Press **Ink Volume**.
The LCD shows the ink volume.
- 3 Press **Stop/Exit**.



Note

You can check the ink volume from your computer.

➤➤Software User's Guide: *Printing* (Windows®)

➤➤Software User's Guide: *Printing and Faxing* (Macintosh)

Packing and shipping the machine

When you transport the machine, use the packing materials that came with your machine. If you do not pack the machine properly, any damage that may occur in transit may not be covered by your warranty.

! IMPORTANT

It is important to allow the machine to "park" the print head after a print job. Listen carefully to the machine before unplugging it to make sure that all mechanical noise has stopped. Not allowing the machine to finish this parking process may lead to print problems and possible damage to the print head.

- 1 Open the ink cartridge cover.
- 2 Press the ink release levers to release the ink cartridges and then take out the ink cartridges. (➤➤Basic User's Guide: *Replacing the ink cartridges*)
- 3 Install the orange protective part and then close the ink cartridge cover.

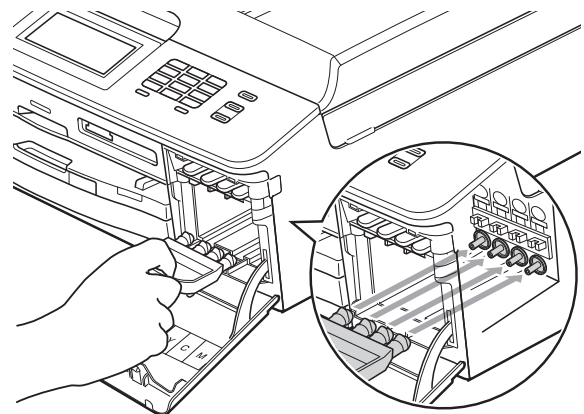

! IMPORTANT

- Make sure the plastic tab on the right side of the orange protective part (1) clicks securely into place (2).

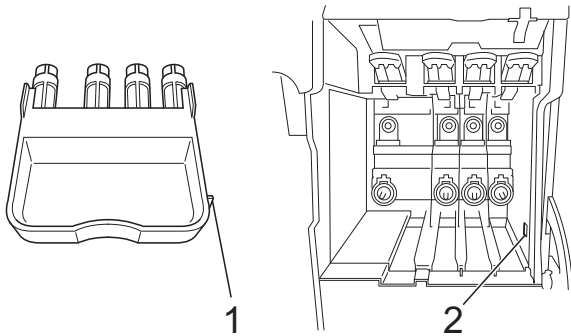

- If you are not able to find the orange protective part, ship the machine without it. DO NOT install the ink cartridges as an alternative before shipping.

- 4 Open the scanner cover and remove the Disc Tray. Place the disc tray in the folded piece of cardboard and tape it together.

- 5 Lift the machine from the front and hook the tab of the orange protective part into the keyed opening (1) on the bottom of the paper tray. Then latch the protective part over the raised portion of the paper tray (2).

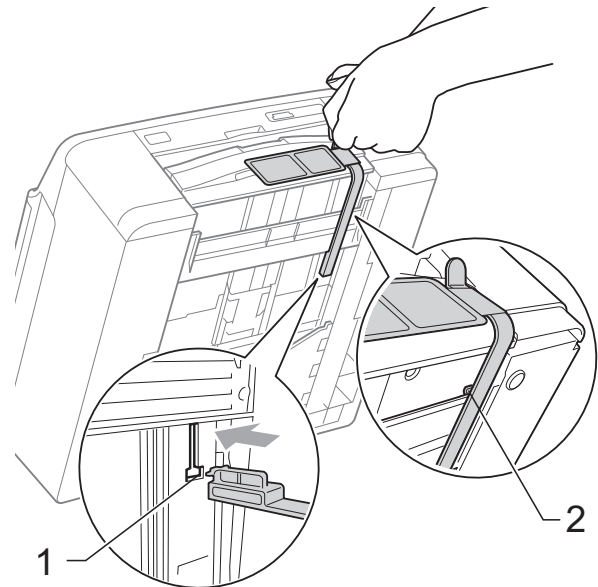

- 6 Unplug the machine from the telephone wall jack and take the telephone line cord out of the machine.
- 7 Unplug the machine from the AC power outlet.
- 8 Using both hands, use the plastic tabs on both sides of the machine to lift the scanner cover into the open position. Then unplug the interface cable from the machine, if it is connected.

- 9 Using both hands, grasp the plastic tabs on both sides of the machine and gently close the scanner cover.

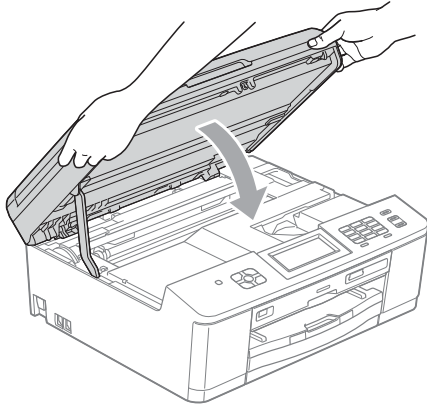

- 10 Wrap the ink cartridges in the bag and tape it on the paper tray.

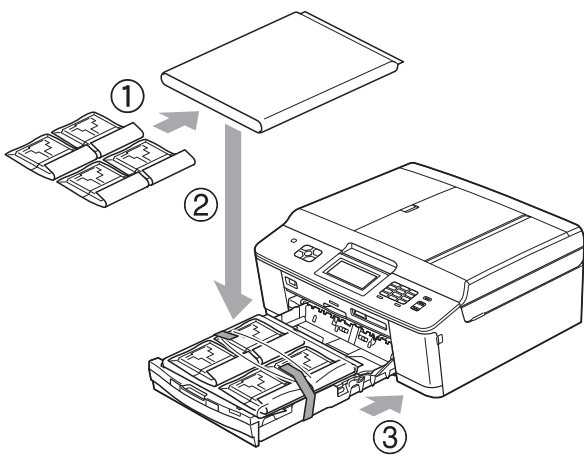

- 11 Wrap the machine in the bag.

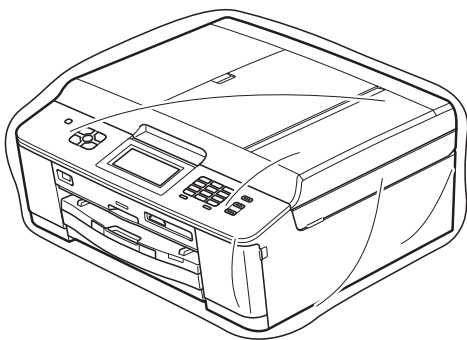

- 12 Pack the machine and the printed materials in the original carton with the original packing material as shown below.



Note

If you are returning your machine to Brother as part of the Exchange Service, pack *only* the machine. Keep all separate parts and printed materials to use with your "Exchange" machine.

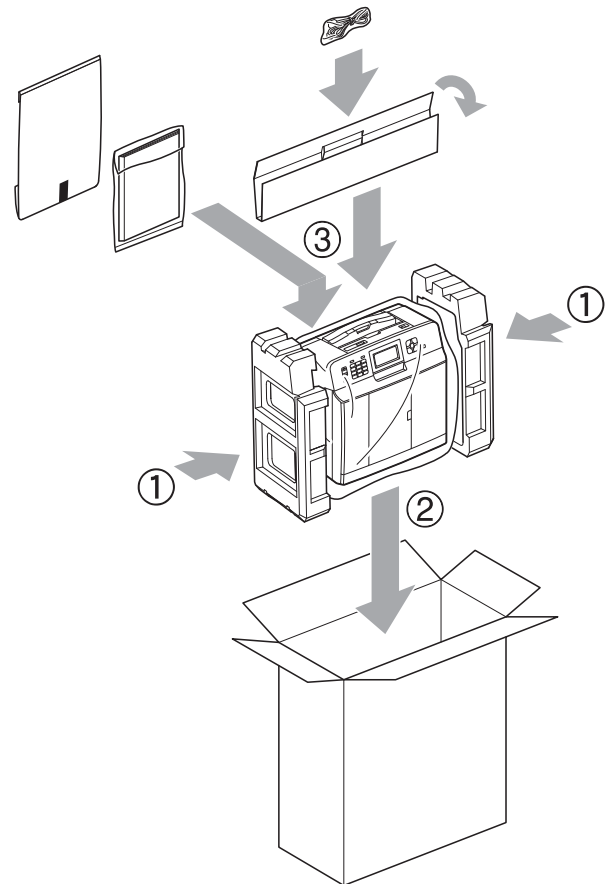

- 13 Close the carton and tape it shut.

B

Glossary

This is a comprehensive list of features and terms that appear in Brother manuals. Availability of these features depends on the model you purchased.

ADF (automatic document feeder)

The document can be placed in the ADF and scanned one page at a time automatically.

Auto Reduction

Reduces the size of incoming faxes.

Automatic Redial

A feature that enables your machine to redial the last fax number after five minutes if the fax did not go through because the line was busy.

Backup Print

Your machine prints a copy of every fax that is received and stored in its memory. This is a safety feature so you will not lose messages during a power failure.

Batch Transmission

(Black & white faxes only) As a cost saving feature, all delayed faxes to the same fax number can be sent as one transmission.

Beeper Volume

Volume setting for the beep when you press a key or make an error.

Brightness

Changing the Brightness makes the whole image lighter or darker.

Broadcasting

The ability to send the same fax message to more than one location.

Caller ID

A service purchased from the telephone company that lets you see the number (or name) of the party calling you.

CNG tones

The special tones (beeps) sent by fax machines during automatic transmission to tell the receiving machine that a fax machine is calling.

Coding method

Method of coding the information contained in the document. All fax machines must use a minimum standard of Modified Huffman (MH). Your machine is capable of greater compression methods, Modified Read (MR), Modified Modified Read (MMR) and JPEG, if the receiving machine has the same capability.

Communication error (Comm. Error)

An error during fax sending or receiving, usually caused by line noise or static.

Compatibility group

The ability of one fax unit to communicate with another. Compatibility is assured between ITU-T Groups.

Contrast

Setting to compensate for dark or light documents, by making faxes or copies of dark documents lighter and light documents darker.

Delayed Fax

Sends your fax at a specified time later.

Density

Changing the Density makes the whole image lighter or darker.

Distinctive Ring

A subscriber service purchased from the telephone company that gives you another telephone number on an existing telephone line. The Brother machine uses the new number to simulate a dedicated fax line.

Dual Access

Your machine can scan outgoing faxes or scheduled jobs into memory at the same time it is sending a fax from memory or receiving or printing an incoming fax.

Easy Receive

Enables your machine to respond to CNG tones if you interrupt a fax call by answering it.

ECM (Error Correction Mode)

Detects errors during fax transmission and resends the pages of the fax that had an error.

Extension telephone

A telephone using the same line as your fax but plugged into a separate wall jack.

External telephone

A telephone that is plugged into the EXT. jack of your machine.

F/T Ring Time

The length of time that the Brother machine rings (when the Receive Mode setting is Fax/Tel) to notify you to pick up a voice call that it answered.

Fax Forwarding

Sends a fax received into the memory to another pre-programmed fax number.

Fax Journal

Lists information about the last 200 incoming and outgoing faxes. TX means Transmit. RX means Receive.

Fax Preview

If you turn on Fax Preview you will be able to view received faxes on the LCD by pressing the **Fax Preview** button on the Touchscreen.

Fax Receive Code

Press this code (* 5 1) when you answer a fax call on an extension or external telephone.

Fax Storage

You can store received faxes in memory.

Fax tones

The signals sent by sending and receiving fax machines while communicating information.

Fax/Tel

You can receive faxes and telephone calls. Do not use this mode if you are using a telephone answering device (TAD).

Fine resolution

Resolution is 203 × 196 dpi. It is used for small print and graphs.

Gray Scale

The shades of gray available for copying, scanning and faxing photographs.

Group number

A combination of Speed Dial numbers that are stored in a Speed Dial location for Broadcasting.

Innobella™

Innobella™ is a range of genuine consumables offered by Brother. For best quality results Brother recommends Innobella™ Ink and Paper.

Journal Period

The pre-programmed time period between automatically printed Fax Journal Reports. You can print the Fax Journal on demand without interrupting the cycle.

LCD (Liquid Crystal Display)

The LCD screen on the machine that shows interactive messages during On-Screen Programming and shows the date and time when the machine is idle.

Manual fax

You can press **Hook** to hear the receiving fax machine answer before you press **Black Start** or **Color Start** to begin sending.

Memory Receive

Receives faxes into the machine's memory when the machine is out of paper.

Menu mode

Programming mode for changing your machine's settings.

OCR (optical character recognition)

ScanSoft™ PaperPort™ 12SE with OCR or Presto! PageManager software application converts an image of text to text you can edit.

Overseas Mode

Makes temporary changes to the fax tones to accommodate noise and static on overseas telephone lines.

Paging

This feature enables your machine to call your cell phone or pager when a fax is received into its memory.

Pause

Allows you to place a 3.5 second delay in the dialing sequence while you are dialing using the dial pad or while you are storing Speed Dial numbers. Press the **Redial/Pause** key on the control panel or the **Pause** button on the Touchscreen as many times as needed for longer pauses.

PhotoCapture Center™

Allows you to print digital photos from your digital camera at high resolution for photo quality printing.

Photo resolution (B&W only)

A resolution setting that uses varying shades of gray for the best representation of photographs.

PictBridge

Allows you to print photos directly from your digital camera at high resolution for photo quality printing.

Polling

The process of a fax machine calling another fax machine to retrieve waiting fax messages.

Pulse (Canada only)

A form of rotary dialing on a telephone line.

Quick Dial List

A listing of names and numbers stored in Speed Dial memory, in numerical order.

Real Time Transmission

When memory is full, you can send faxes in real time.

Remaining jobs

You can check which jobs are waiting in memory and cancel jobs individually.

Remote Access Code

Your own four-digit code (---*) that allows you to call and access your machine from a remote location.

Remote Retrieval Access

The ability to access your machine remotely from a touch-tone telephone.

Resolution

The number of vertical and horizontal lines per inch. See: Standard, Fine, Super Fine and Photo.

Ring Delay

The number of rings before the machine answers in **Fax Only** and **Fax/Tel** modes.

Ring Volume

Volume setting for the machine's ring.

Scanning

The process of sending an electronic image of a paper document into your computer.

Scan to Media

You can scan a black & white or color document on to a memory card or USB Flash memory drive. Black & white images can be in TIFF or PDF file format and color images can be in PDF or JPEG file format.

Search

An electronic, numerical or alphabetical listing of stored Speed Dial and Group numbers.

Speed Dial

A pre-programmed number for easy dialing.

Standard resolution

203 × 98 dpi (black & white).
203 × 196 dpi (color). It is used for regular sized text and quickest transmission.

Station ID

The stored information that appears on the top of faxed pages. It includes the sender's name and fax number.

Super Fine resolution (B&W)

203 × 392 dpi. Best for very small print and line art.

TAD (telephone answering device)

You can connect an external telephone answering device or answering machine to the EXT. jack of your machine.

**Telephone Answer Code
(For Fax/Tel mode only)**

When the machine answers a voice call, it pseudo/double-rings. You can pick up at an extension telephone by pressing this code (**# 5 1**).

Temporary settings

You can choose certain options for each fax transmission and copy without changing the default settings.

Tone

A form of dialing on the telephone line used for touch-tone telephones.

Transmission

The process of sending faxes over the phone lines from your machine to the receiving fax machine.

Transmission Verification Report

A listing for the last fax sent, that shows its date, time and number.

True2Life™

Adjusts the color in the image for better print quality by improving sharpness, white balance and color density.

User Settings

A printed report that shows the current settings of the machine.

WLAN Report

A printed report that shows the result of the WLAN Connection.

C

Index

Numerics

2 in 1 ID Copy 39

A

Access codes, storing and dialing 30

Apple Macintosh
See Software User's Guide.

B

Broadcasting 10
setting up Groups for 32

C

Caller ID 26

Caller ID history 29

Add to Speed Dial 29

Delete 29

Send a fax 29

Caller ID History report 35

Setting up your area code 27

Canceling

Fax Forwarding 19, 21

Fax Storage 19

jobs awaiting redial 13

Paging 19, 21

Cleaning

paper feed rollers 63

paper pick-up rollers 64

printer platen 62

Connecting

two-line external TAD or telephone 28

ControlCenter

See Software User's Guide.

Copy

2 in 1 ID 39

book 42

density 40

duplex 44

enlarge/reduce 37

favorite settings 45

ink save mode 41

page layout (N in 1) 38

poster 38

quality 36

sort (ADF only) 40

thin paper 41

using ADF 40

Watermark 42

using a media card 43

using a paper document 43

using a template 42

using a USB Flash memory drive 43

D

Dialing

access codes and credit card

numbers 30

Caller ID history 29

Groups (Broadcasting) 10

Outgoing Call 29

Direct printing

from a non-PictBridge camera 60

from a PictBridge camera 57

Dual Access 9

Duplex (2-sided)

copy 44

F

Fax codes	
changing	20
Remote Access Code	20
Fax Forwarding	
changing remotely	21, 22
programming a number	15
Fax Storage	17
printing from memory	17
turning off	19
turning on	17
Fax, from PC	
See Software User's Guide.	
Fax, stand-alone	
receiving	
at end of conversation	23
Fax Forwarding	21
into PC	18
into the memory	15
out of paper reception	15
Paging	16
printing from memory	17
reducing to fit on paper	23
retrieving from a remote site	21, 22
sending	7
at end of conversation	9
Broadcasting	10
canceling from memory	13
contrast	7
delayed batch transmission	13
delayed fax	12
from memory (Dual Access)	9
manual	9
overseas	12
Real Time Transmission	11
Resolution	8
return to factory setting	8
set new default	8

G

Groups for Broadcasting	32
-------------------------------	----

I

ID Copy	39
Ink cartridges	
checking ink volume	65

J

Jacks	
Convert to RJ11 jack triplex adapter	28
EXT	
TAD	28

L

LCD (Liquid Crystal Display)	
Brightness	4
Dim Timer	4

M

Macintosh	
See Software User's Guide.	
Manual	
transmission	9
Memory Security	6
Memory Storage	1
Mode, entering	
Timer	4
Movie printing	47

N

Network	
Printing	
See Network User's Guide.	
Scanning	
See Software User's Guide.	

O

Outgoing Call	
Add to Speed Dial	29
Delete	29
Send a fax	29

P

Packing and shipping the machine	65
Paging	16
PaperPort™ 12SE with OCR	
See Software User's Guide. See also Help in the PaperPort™ 12SE application.	
PhotoCapture Center™	
Adding Effect	48
DPOF printing	50
from PC	
See Software User's Guide.	
Photo Effects	
Auto Correct	48
Enhance Scenery	48
Enhance Skin	48
Fill Light	48
Monochrome	48
Night Scene	48
Remove Red-Eye	48
Sepia	48
Trim	48
Whiteboard	48
Print settings	
Borderless	54
Brightness	52
Contrast	52
Cropping	53
Paper type & size	51
Print Date	54
Quality	51
Return to factory setting	54
Set new default	54
Printing	
index	47
photos	48
Scan to Media	
auto crop	55
memory card	55
USB Flash memory	55
PictBridge	
DPOF Printing	59
Power failure	1
Presto! PageManager	
See Software User's Guide. See also Help in the Presto! PageManager application.	
Print	
fax from memory	17
report	35

Printing
 See Software User's Guide.

Q

Quick Dial	
Access codes and credit card numbers	30
Broadcasting	10
deleting Groups	33
using Groups	10
Group dial	
changing	33
setting up Groups for Broadcasting	32
Speed Dial	
setting up from Caller ID history	31
setting up from outgoing calls	31

R

Reducing	
copies	37
incoming faxes	23
Remote Retrieval	20
commands	21
getting your faxes	22
remote access code	20
Remote Setup	
See Software User's Guide.	
Reports	34
Caller ID History Report	35
Fax Journal	35
Journal Period	34
how to print	35
Network Configuration	35
Quick Dial List	35
Transmission Verification	34, 35
User Settings	35
WLAN Report	35
Resolution	
setting for next fax	8

S

Scanning	
See Software User's Guide.	
Shipping the machine	65
Sleep Mode	3
Speed Dial	
setting up from Caller ID history	31
setting up from outgoing calls	31

T

TAD (telephone answering device),	
external	28
with two-line jack	28
Telephone line	
roll over lines	27
two-line telephone system	27
Troubleshooting	
checking ink volume	65
Two-line telephone system	27

V

Volume, setting	
beeper	2
ring	1
speaker	2

W

Warranties are in the box	
Windows®	
See Software User's Guide.	
Wireless Network	
See Quick Setup Guide and Network	
User's Guide.	

Brother International Corporation
100 Somerset Corporate Boulevard
P.O. Box 6911
Bridgewater, NJ 08807-0911 USA

Brother International Corporation (Canada) Ltd.
1 rue Hôtel de Ville,
Dollard-des-Ormeaux, QC, Canada H9B 3H6

brother®

Visit us on the World Wide Web
<http://www.brother.com/>

These machines are approved for use in the country of purchase only. Local Brother companies or their dealers will only support machines purchased in their own countries.

Free Manuals Download Website

<http://myh66.com>

<http://usermanuals.us>

<http://www.somanuals.com>

<http://www.4manuals.cc>

<http://www.manual-lib.com>

<http://www.404manual.com>

<http://www.luxmanual.com>

<http://aubethermostatmanual.com>

Golf course search by state

<http://golfingnear.com>

Email search by domain

<http://emailbydomain.com>

Auto manuals search

<http://auto.somanuals.com>

TV manuals search

<http://tv.somanuals.com>