



# Online User's Guide

**HL-L2310D**

**HL-L2350DW**

**HL-L2357DW**

**HL-L2370DN**

**HL-L2375DW**

## Table of Contents

<b>Before You Use Your Brother Machine</b> .....	<b>1</b>
Definitions of Notes .....	2
Trademarks .....	3
Important Note .....	4
<b>Introduction to Your Brother Machine</b> .....	<b>5</b>
Control Panel Overview .....	6
LED Patterns and Indications (for Models Without an LCD) .....	9
Access Brother Utilities (Windows®) .....	11
Uninstall the Brother Software and Drivers (Windows®) .....	13
<b>Paper Handling</b> .....	<b>14</b>
Load Paper.....	15
Load and Print Using the Paper Tray .....	16
Load and Print Paper in the Manual Feed Slot .....	19
Paper Settings.....	25
Change the Paper Size and Paper Type.....	26
Change the Check Paper Size Setting .....	27
Unprintable Area .....	28
Recommended Print Media.....	29
Using Special Paper.....	30
<b>Print</b> .....	<b>31</b>
Print from Your Computer (Windows®) .....	32
Print a Document (Windows®).....	33
Print Settings (Windows®).....	35
Change the Default Print Settings (Windows®).....	39
Monitor the Status of the Machine from Your Computer (Windows®) .....	40
Print from Your Computer (Mac) .....	41
Print a Document (Mac) .....	42
Print Options (Mac) .....	43
Monitor the Status of the Machine from Your Computer (Mac) .....	48
Cancel a Print Job.....	49
Test Print .....	50
<b>Network</b> .....	<b>51</b>
Supported Basic Network Features .....	52
Network Management Software and Utilities .....	53
Learn about Network Management Software and Utilities .....	54
Additional Methods of Configuring Your Brother Machine for a Wireless Network .....	55
Before Configuring Your Brother Machine for a Wireless Network.....	56
Configure Your Machine for a Wireless Network.....	57
Configure Your Machine for a Wireless Network Using the One Push Method of Wi-Fi Protected Setup™ (WPS).....	58
Configure Your Machine for a Wireless Network Using the PIN Method of Wi-Fi Protected Setup™ (WPS).....	59
Configure Your Machine for a Wireless Network Using the Machine's Control Panel Setup Wizard .....	62
Configure Your Machine for a Wireless Network When the SSID Is Not Broadcast .....	64

Use Wi-Fi Direct® .....	66
Advanced Network Features .....	76
Print the Network Configuration Report .....	77
Print the WLAN Report .....	78
Technical Information for Advanced Users .....	81
Reset the Network Settings to the Factory Settings .....	82
<b>Security .....</b>	<b>83</b>
Lock the Machine Settings .....	84
Setting Lock Overview .....	85
Network Security Features .....	89
Before Using Network Security Features .....	90
Manage Your Network Machine Securely Using SSL/TLS .....	91
Send an Email Securely .....	124
<b>Mobile .....</b>	<b>129</b>
Google Cloud Print .....	130
Google Cloud Print Overview .....	131
Before Using Google Cloud Print .....	132
Print from Google Chrome™ or Chrome OS™ .....	136
Print from Google Drive™ for Mobile .....	137
Print from Gmail™ Webmail Service for Mobile .....	138
AirPrint .....	139
AirPrint Overview .....	140
Before Using AirPrint .....	141
Print Using AirPrint .....	144
Mobile Printing for Windows® .....	148
Mopria® Print Service .....	149
Brother iPrint&Scan for Mobile Devices .....	150
<b>Brother iPrint&amp;Scan for Windows® and Mac .....</b>	<b>151</b>
Brother iPrint&Scan Overview .....	152
<b>Troubleshooting .....</b>	<b>153</b>
Error and Maintenance Indications .....	154
Error and Maintenance Messages .....	157
Paper Jams .....	160
Paper is Jammed in the Paper Tray .....	161
Paper is Jammed in the Back of the Machine .....	162
Paper is Jammed inside the Machine .....	164
Paper is Jammed in the 2-sided Tray .....	165
Printing Problems .....	167
Improve the Print Quality .....	170
Network Problems .....	175
Error Messages .....	176
Where Can I Find My Brother Machine's Network Settings? .....	177
I Cannot Complete the Wireless Network Setup Configuration .....	178
Use the Network Connection Repair Tool (Windows®) .....	180
My Brother Machine Cannot Print over the Network .....	181
I Want to Check that My Network Devices are Working Correctly .....	183







Google Cloud Print Problems.....	184
AirPrint Problems .....	185
Other Problems .....	186
Machine Information.....	187
Check the Serial Number .....	188
Check the Firmware Version .....	189
Reset Functions Overview .....	190
Reset Your Brother Machine .....	191
<b>Routine Maintenance .....</b>	<b>192</b>
Replace Supplies .....	193
Replace the Toner Cartridge .....	195
Replace the Drum Unit.....	197
Clean the Machine .....	199
Clean the Corona Wire.....	201
Clean the Drum Unit Using Drum Dot Print.....	202
Clean the Paper Pick-up Rollers .....	207
Check the Remaining Part Life .....	208
Pack and Ship Your Brother Machine .....	209
<b>Machine Settings.....</b>	<b>210</b>
Change Machine Settings from the Control Panel.....	211
General Settings.....	212
Menu Table (for LCD Models) .....	219
How to Install the Remote Printer Console Software (Windows® only) .....	227
Change Machine Settings from Your Computer.....	228
Change Machine Settings Using Web Based Management .....	229
<b>Appendix.....</b>	<b>233</b>
Specifications .....	234
How to Enter Text on Your Brother Machine .....	239
Supplies .....	240
Information Regarding Recycled Paper .....	242
Brother Numbers.....	243

## Before You Use Your Brother Machine

- [Definitions of Notes](#)
- [Trademarks](#)
- [Important Note](#)

## Definitions of Notes

We use the following symbols and conventions throughout this User's Guide:

 <b>WARNING</b>	WARNING indicates a potentially hazardous situation which, if not avoided, could result in death or serious injuries.
 <b>CAUTION</b>	CAUTION indicates a potentially hazardous situation which, if not avoided, may result in minor or moderate injuries.
<b>IMPORTANT</b>	IMPORTANT indicates a potentially hazardous situation which, if not avoided, may result in damage to property or loss of product functionality.
<b>NOTE</b>	NOTE specifies the operating environment, conditions for installation, or special conditions of use.
	Tips icons indicate helpful hints and supplementary information.
	Electrical Hazard icons alert you to possible electrical shock.
	Fire Hazard icons alert you to the possibility of a fire.
	Hot Surface icons warn you not to touch hot machine parts.
	Prohibition icons indicate actions you must not perform.
<b>Bold</b>	Bold style identifies buttons on the machine's control panel or computer screen.
<i>Italics</i>	Italicised style emphasises an important point or refers you to a related topic.
Courier New	Courier New font identifies messages shown on the machine's LCD.

### Related Information

- [Before You Use Your Brother Machine](#)

## Trademarks

BROTHER is either a trademark or a registered trademark of Brother Industries, Ltd.

Microsoft, Windows, Windows Server and Internet Explorer are either registered trademarks or trademarks of Microsoft Corporation in the United States and/or other countries.

Apple, Mac, Safari, AirPrint, the AirPrint logo, iPad, iPhone and iPod touch are trademarks of Apple Inc., registered in the United States and other countries.

macOS is a trademark of Apple Inc.

App Store is a service mark of Apple Inc.

PostScript and PostScript 3 are either registered trademarks or trademarks of Adobe Systems Incorporated in the United States and/or other countries.

Wi-Fi, Wi-Fi Alliance and Wi-Fi Direct are registered trademarks of Wi-Fi Alliance®.

WPA, WPA2, Wi-Fi CERTIFIED, Wi-Fi Protected Setup and Wi-Fi Protected Setup logo are trademarks of Wi-Fi Alliance®.

Android, Gmail, Google Cloud Print, Google Drive, Google Chrome, Chrome OS and Google Play are trademarks of Google Inc. Use of these trademarks is subject to Google Permissions.

Mopria® and the Mopria® Logo are registered trademarks and service marks of Mopria Alliance, Inc. in the United States and other countries. Unauthorised use is strictly prohibited.

Mozilla and Firefox are registered trademarks of the Mozilla Foundation.

Intel is a trademark of Intel Corporation in the U.S. and/or other countries.

The Bluetooth® word mark is a registered trademark owned by the Bluetooth SIG, Inc. and any use of such marks by Brother Industries, Ltd. is under license.

Each company whose software title is mentioned in this manual has a Software License Agreement specific to its proprietary programs.

**Any trade names and product names of companies appearing on Brother products, related documents and any other materials are all trademarks or registered trademarks of those respective companies.**



### Related Information

- [Before You Use Your Brother Machine](#)

## Important Note

- Do not use this product outside the country of purchase as it may violate the wireless telecommunication and power regulations of that country.
- Not all models are available in all countries.
- Windows® 10 in this document represents Windows® 10 Home, Windows® 10 Pro, Windows® 10 Education and Windows® 10 Enterprise.
- Windows Server® 2008 in this document represents Windows Server® 2008 and Windows Server® 2008 R2.
- In this User's Guide, the LCD messages of the HL-L2375DW are used unless otherwise specified.
- In this User's Guide, the illustrations of the HL-L2375DW are used unless otherwise specified.
- The screens in this User's Guide are for illustration purposes only and may differ from the actual screens.
- Unless otherwise specified, the screens in this manual are from Windows® 7 and macOS v10.10.5. Screens on your computer may vary depending on your operating system.
- The contents of this guide and the specifications of this product are subject to change without notice.
- Not all features are available in countries subject to applicable export restrictions.



### Related Information

- [Before You Use Your Brother Machine](#)
-



## Introduction to Your Brother Machine



- [Control Panel Overview](#)
- [LED Patterns and Indications \(for Models Without an LCD\)](#)
- [Access Brother Utilities \(Windows®\)](#)

## Control Panel Overview

### HL-L2310D



#### 1. Power On/Off Button

- Turn on the machine by pressing .
- Turn off the machine by pressing and holding .

#### 2. Toner LED

The **Toner** LED indicates that the Toner is low.

#### 3. Drum LED

The **Drum** LED indicates that the Drum Unit must be replaced soon.

#### 4. Paper LED

The **Paper** LED indicates that there is an error relating to paper feeding.

#### 5. Ready LED

The **Ready** LED blinks to indicate the machine's status.

#### 6. Go Button

- Press **Go** to clear certain errors.
- Press **Go** to print any data remaining in the machine's memory.
- Press and hold **Go** for about two seconds to cancel a print job.

### HL-L2350DW/HL-L2357DW/HL-L2370DN/HL-L2375DW

The control panel will vary depending on your model.

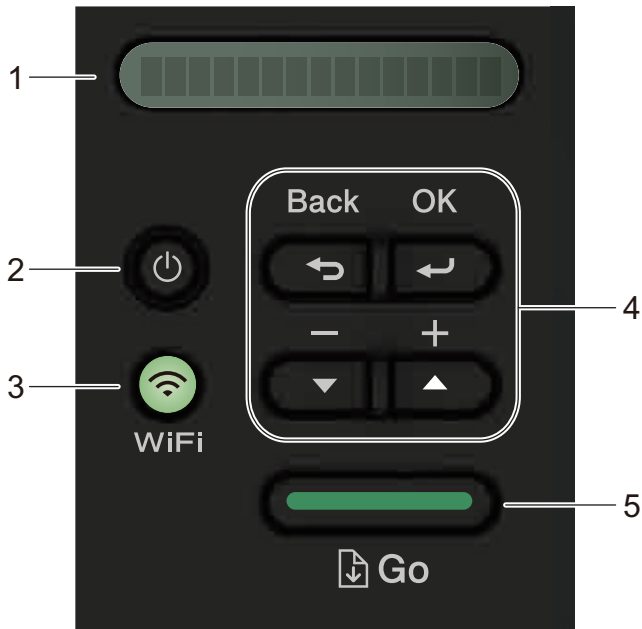

### 1. LCD (Liquid Crystal Display)



Displays messages to help you set up and use your machine.

Wireless Models:

A four-level indicator shows the wireless signal strength if you are using a wireless connection.



### 2. Power On/Off Button

- Turn on the machine by pressing .
- Turn off the machine by pressing and holding . The LCD displays [Shutting Down] for a few seconds before going off.

### 3. Network Buttons

- Wired Models:

#### Network

Press **Network** to set up wired network settings.

- Models with Wireless Function:

#### WiFi

Press the **WiFi** button and launch the wireless installer on your computer. Follow the on-screen instructions to set up a wireless connection between your machine and your network.

When the **WiFi** light is on, your Brother machine is connected to a wireless access point. When the **WiFi** light blinks, the wireless connection is down, or your machine is in the process of connecting to a wireless access point.

### 4. Menu Buttons

#### OK

Press to store your machine settings. After you change a setting, the machine returns to the previous menu level.

#### Back

- Press to go back one level in the menu.
- Press to select the previous digit when setting numbers.

#### ▲ or ▼ ( + or - )

- Press to scroll through menus and options.

- 
- Press to enter a number or to increase or decrease the number. Press and hold down ▲ or ▼ to scroll faster. When you see the number you want, press **OK**.

#### 5. Go Button

- Press to clear certain error messages. To clear all other errors, follow the control panel instructions.
- Press to print any data remaining in the machine's memory.
- Press to select the displayed option. After you change a setting, the machine returns to Ready mode.
- Press and hold **Go** for about two seconds to cancel a print job.



#### Related Information

- [Introduction to Your Brother Machine](#)
-

## LED Patterns and Indications (for Models Without an LCD)

Related Models: HL-L2310D

The LEDs on your machine's control panel light up, dim, or blink to indicate machine status.

**LED indications are defined in the table below.**

	LED is off.
	LED is on.
	LED is dimmed.
	LED is blinking.

**This table defines what LEDs indicate when they light up, dim, or blink.**

LED indication	Status	Meaning
<ul style="list-style-type: none"> <li><input type="radio"/>  Toner</li> <li><input type="radio"/>  Drum</li> <li><input type="radio"/>  Paper</li> <li><input type="radio"/>  Ready</li> </ul>	Sleep	In Sleep mode (Power Save mode), the machine acts as if it is turned off, but it can still receive data. Receiving a print job will wake the machine and it will start printing.
	Deep Sleep	In Deep Sleep mode (lower power consumption than Sleep mode), the machine acts as if it is turned off, but it can still receive data. If the machine does not receive data for the length of time you specify, it enters Deep Sleep mode. Receiving a print job will wake the machine and it will start printing.
<ul style="list-style-type: none"> <li><input type="radio"/>  Toner</li> <li><input type="radio"/>  Drum</li> <li><input type="radio"/>  Paper</li> <li><input checked="" type="radio"/>  Ready</li> </ul>	Ready	The machine is ready to print.
<ul style="list-style-type: none"> <li><input type="radio"/>  Toner</li> <li><input type="radio"/>  Drum</li> <li><input type="radio"/>  Paper</li> <li><input checked="" type="radio"/>  Ready</li> </ul>	Please Wait	The machine is warming up.
	Printing	The machine is printing.
	Cooling Down	The machine is cooling down. Wait for 10 minutes or until the inside of the machine has cooled down.
<ul style="list-style-type: none"> <li><input type="radio"/>  Toner</li> <li><input type="radio"/>  Drum</li> <li><input checked="" type="radio"/>  Paper</li> <li><input checked="" type="radio"/>  Ready</li> </ul>	Cancel Printing	The machine is canceling the job.



---

## Related Information

---

- [Introduction to Your Brother Machine](#)
-

## Access Brother Utilities (Windows®)

**Brother Utilities** is an application launcher that offers convenient access to all Brother applications installed on your computer.

1. Do one of the following:

- (Windows® 7, Windows Server® 2008 and Windows Server® 2008 R2)

Click  (**Start**) > **All Programs** > **Brother** > **Brother Utilities**.

- (Windows® 8 and Windows Server® 2012)

Tap or click  (**Brother Utilities**) either on the **Start** screen or the desktop.

- (Windows® 8.1 and Windows Server® 2012 R2)

Move your mouse to the lower left corner of the **Start** screen and click  (if you are using a touch-based device, swipe up from the bottom of the **Start** screen to bring up the **Apps** screen).

When the **Apps** screen appears, tap or click  (**Brother Utilities**).

- (Windows® 10 and Windows Server® 2016)

Click  > **Brother** > **Brother Utilities**.

2. Select your machine (where XXXX is the name of your model).

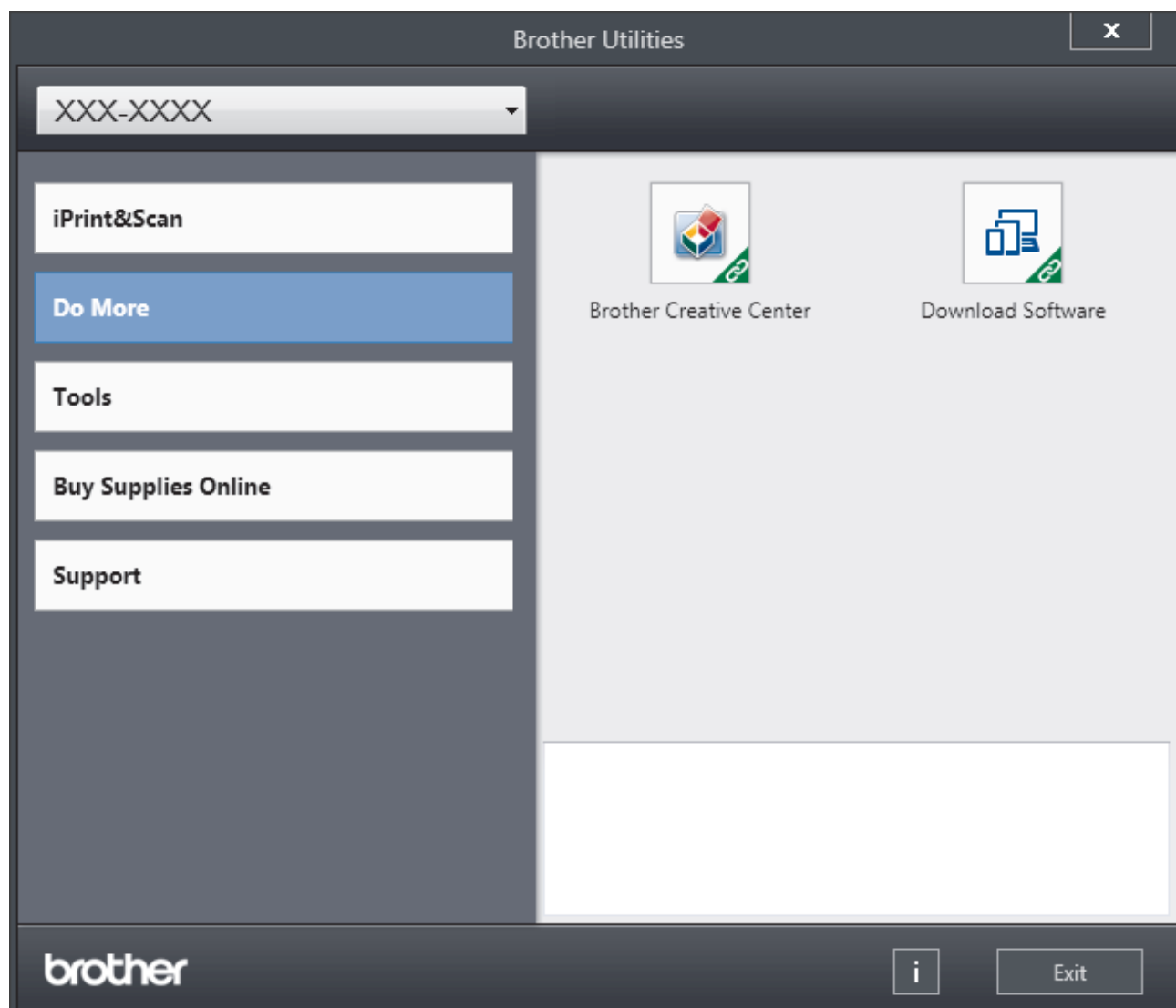

3. Choose the operation you want to use.



---

## Related Information

---

- [Introduction to Your Brother Machine](#)
  - [Uninstall the Brother Software and Drivers \(Windows®\)](#)
-



## Uninstall the Brother Software and Drivers (Windows®)

1. Do one of the following:

- (Windows® 7, Windows Server® 2008 and Windows Server® 2008 R2)

Click  (**Start**) > **All Programs** > **Brother** > **Brother Utilities**.

- (Windows® 8 and Windows Server® 2012)

Tap or click  (**Brother Utilities**) either on the **Start** screen or the desktop.

- (Windows® 8.1 and Windows Server® 2012 R2)

Move your mouse to the lower left corner of the **Start** screen and click  (if you are using a touch-based device, swipe up from the bottom of the **Start** screen to bring up the **Apps** screen).

When the **Apps** screen appears, tap or click  (**Brother Utilities**).

- (Windows® 10 and Windows Server® 2016)

Click  > **Brother** > **Brother Utilities**.

2. Click the drop-down list, and then select your model name (if not already selected). Click **Tools** in the left navigation bar, and then click **Uninstall**.

Follow the instructions in the dialog box to uninstall the software and drivers.



### Related Information

- [Access Brother Utilities \(Windows®\)](#)

## Paper Handling

- [Load Paper](#)
- [Paper Settings](#)
- [Unprintable Area](#)
- [Recommended Print Media](#)
- [Using Special Paper](#)

## Load Paper

- [Load and Print Using the Paper Tray](#)
- [Load and Print Paper in the Manual Feed Slot](#)

## Load and Print Using the Paper Tray

- [Load Paper in the Paper Tray](#)

## Load Paper in the Paper Tray

- If the Check Size setting is set to On and you pull the paper tray out of the machine, a message appears on the LCD asking if you want to change the paper size and paper type. Change the paper size and paper type settings if needed, following the LCD instructions.
- When you load a different size and type of paper in the tray, you must also change the Paper Size and Paper Type settings in the machine, or on your computer.

1. Pull the paper tray completely out of the machine.

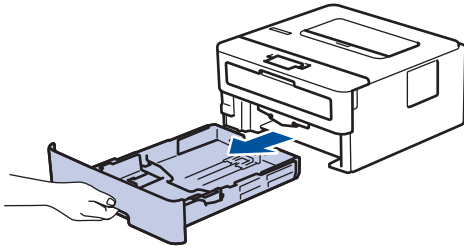

2. Press and slide the paper guides to fit the paper.  
Press the green release levers to slide the paper guides.

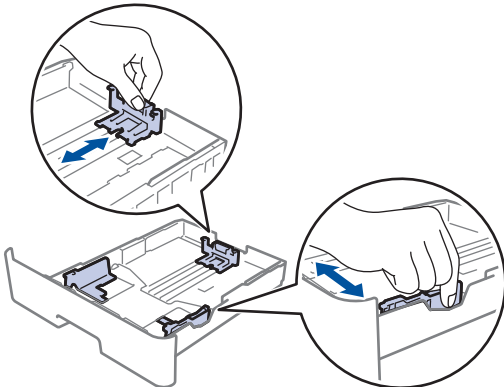

3. Fan the stack of paper well.
4. Load paper in the paper tray with the printing surface *face down*.
5. Make sure the paper is below the maximum paper mark (▼▼▼).  
Overfilling the paper tray will cause paper jams.

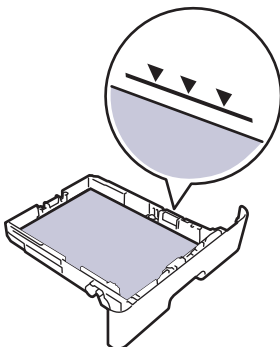

6. Slowly push the paper tray completely into the machine.
7. Lift the support flap to prevent paper from sliding off the output tray.

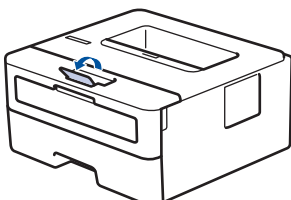



## Related Information

- [Load and Print Using the Paper Tray](#)
-

## Load and Print Paper in the Manual Feed Slot

- [Load and Print Plain Paper, Thin Paper, Recycled Paper and Bond Paper in the Manual Feed Slot](#)
- [Load and Print on Thick Paper and Labels in the Manual Feed Slot](#)
- [Load and Print on Envelopes in the Manual Feed Slot](#)

## Load and Print Plain Paper, Thin Paper, Recycled Paper and Bond Paper in the Manual Feed Slot

When you load a different paper size in the tray, you must change the Paper Size setting in the machine or on your computer at the same time.

1. Lift the support flap to prevent paper from sliding off the face down output tray.

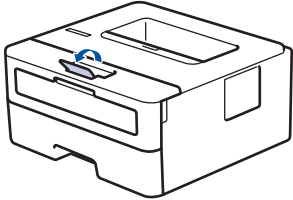

2. Open the manual feed slot cover.

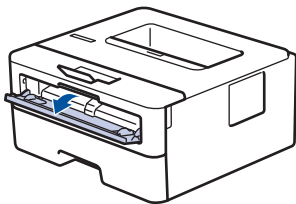

3. Use both hands to slide the manual feed slot paper guides to fit the width of the paper you are using.

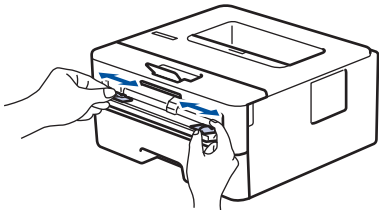

4. Using both hands, put one full sheet of paper in the manual feed slot until the front edge touches the paper feed roller. When you feel the machine pull it in, let go.

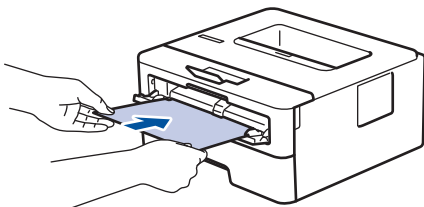

- Load paper into the manual feed slot with the printing surface facing up.
- Make sure the paper is straight and in the correct position in the manual feed slot. If it is not, the paper may not be fed correctly, resulting in a skewed printout or a paper jam.

5. Send your print job to the machine.



Change your print preferences in the Print screen before sending the print job from your computer.

6. After the printed page comes out from the machine, load the next sheet of paper in the manual feed slot. Repeat for each page that you want to print.



### Related Information

- [Load and Print Paper in the Manual Feed Slot](#)



## Load and Print on Thick Paper and Labels in the Manual Feed Slot

When you load a different paper size in the tray, you must change the Paper Size setting in the machine or on your computer at the same time.

1. Open the machine's back cover (the face up output tray).

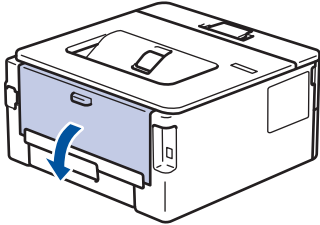

 The machine automatically turns on Manual Feed mode when you load paper in the manual feed slot.

2. On the front of the machine, open the manual feed slot cover.

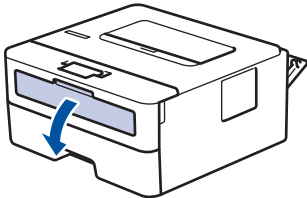

3. Use both hands to slide the manual feed slot paper guides to fit the width of the paper that you are using.

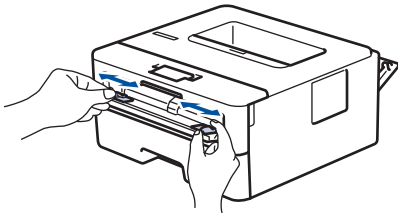

4. Using both hands, put one full sheet of paper in the manual feed slot until the front edge touches the paper feed roller. When you feel the machine pull it in, let go.

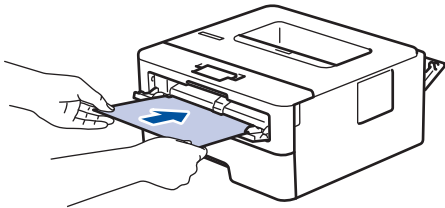

- 
- Load paper into the manual feed slot with the printing surface facing up.
  - Pull the paper out completely if you must reload the paper into the manual feed slot.
  - Do not put more than one sheet of paper in the manual feed slot at one time, as it may cause a jam.
  - Make sure the paper is straight and in the correct position in the manual feed slot. If it is not, the paper may not be fed correctly, resulting in a skewed printout or a paper jam.

5. Send your print job to the machine.

 Change your print preferences in the Print screen before sending the print job from your computer.

6. After the printed page comes out from the back of the machine, load the next sheet of paper in the manual feed slot. Repeat for each page that you want to print.
7. Close the back cover (the face up output tray) until it locks in the closed position.



## Related Information

- [Load and Print Paper in the Manual Feed Slot](#)
-

## Load and Print on Envelopes in the Manual Feed Slot

When you load a different paper size in the tray, you must change the Paper Size setting in the machine or on your computer at the same time.

1. Open the machine's back cover (the face up output tray).

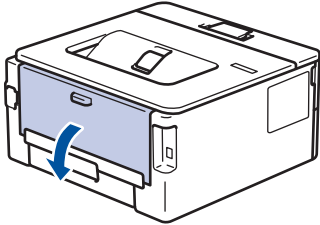

 The machine automatically turns on Manual Feed mode when you load paper in the manual feed slot.

2. Pull down the two green levers, one on the left side and one on the right side, as shown in the illustration.

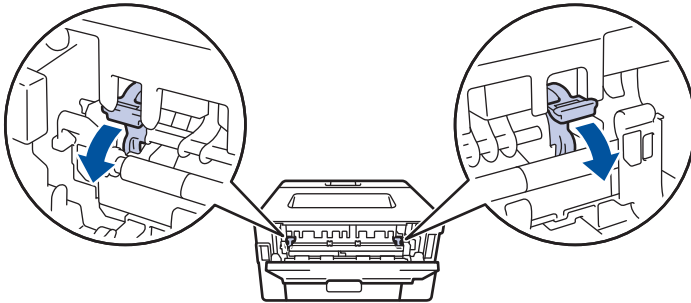

3. On the front of the machine, open the manual feed slot cover.

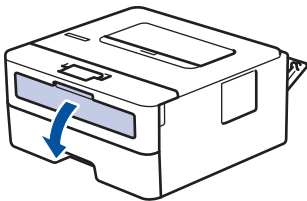

4. Use both hands to slide the manual feed slot paper guides to fit the width of the paper that you are using.

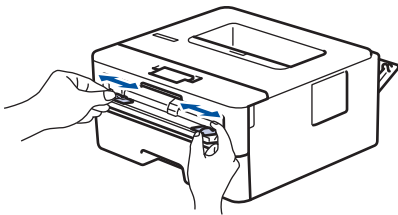

5. Using both hands, put one envelope in the manual feed slot until the front edge touches the paper feed roller. When you feel the machine pull it in, let go.

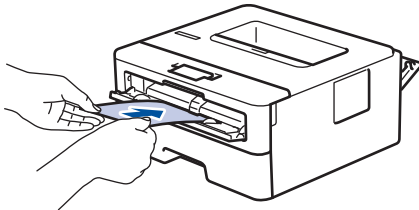



- Load the envelope into the manual feed slot with the printing surface facing up.
- Pull the envelope out completely when you reload the envelope into the manual feed slot.
- Do not put more than one envelope in the manual feed slot at one time, as it may cause a jam.
- Make sure the envelope is straight and in the correct position on the manual feed slot. If it is not, the envelope may not be fed correctly, resulting in a skewed printout or a paper jam.

6. Send your print job to the machine.



Change your print preferences in the Print dialog box before sending the print job from your computer.

Settings	Options for Envelopes
Paper Size	Com-10 DL C5 Monarch
Media Type	Envelopes Env. Thick Env. Thin

7. After the printed envelope comes out of the machine, put in the next envelope. Repeat for each envelope that you want to print.
8. When you have finished printing, return the two green levers you adjusted in the earlier step back to their original positions.
9. Close the back cover (the face up output tray) until it locks in the closed position.



### Related Information

- [Load and Print Paper in the Manual Feed Slot](#)

## Paper Settings

- [Change the Paper Size and Paper Type](#)
- [Change the Check Paper Size Setting](#)

## Change the Paper Size and Paper Type

When you change the size and type of the paper you load in the tray, you must change the Paper Size and Paper Type settings on the LCD at the same time.

1. Press ▲ or ▼ to display the [General Setup] option, and then press **OK**.
2. Press ▲ or ▼ to display the [Tray Setting] option, and then press **OK**.
3. Press ▲ or ▼ to display the [Paper Type] option, and then press **OK**.
4. Press ▲ or ▼ to display the paper type you want, and then press **OK**.
5. Press ▲ or ▼ to display the [Paper Size] option, and then press **OK**.
6. Press ▲ or ▼ to display the paper size you want, and then press **Go**.



### Related Information

- [Paper Settings](#)

## Change the Check Paper Size Setting

**Related Models:** HL-L2350DW/HL-L2357DW/HL-L2370DN/HL-L2375DW

When you turn on your machine's Check Size setting, the machine displays a message when you remove a paper tray, asking if you changed the paper size and paper type.

The default setting is On.

1. Press ▲ or ▼ to display the [General Setup] option, and then press **OK**.
2. Press ▲ or ▼ to select the [Tray Setting] option, and then press **OK**.
3. Press ▲ or ▼ to select the [Check Size] option, and then press **OK**.
4. Press ▲ or ▼ to select the [On] or [Off] option, and then press **Go**.



### Related Information

- [Paper Settings](#)

## Unprintable Area

The measurements in the table below show maximum unprintable areas from the edges of the most commonly-used paper sizes. The measurements may vary depending on the paper size or settings in the application you are using.

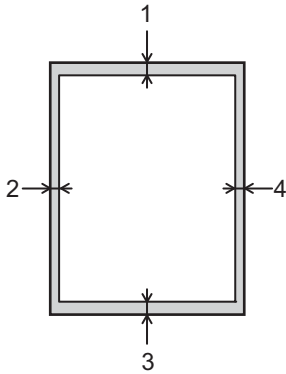

Do not attempt to print into these areas; your output will not reflect anything in these areas.

Usage	Document Size	Top (1) Bottom (3)	Left (2) Right (4)
Print	Letter	4.23 mm	4.23 mm
	A4	4.23 mm	4.23 mm
	Legal	4.23 mm	4.23 mm



### Related Information

- [Paper Handling](#)



## Recommended Print Media

To get the best print quality, we recommend using the paper listed in the table.

Paper Type	Item
Plain Paper	Xerox Premier TCF 80 g/m <sup>2</sup>
	Xerox Business 80 g/m <sup>2</sup>
Recycled Paper	Steinbeis Evolution White 80 g/m <sup>2</sup>
Labels	Avery laser label L7163
Envelopes	Antalis River series (DL)



### Related Information

- [Paper Handling](#)

## Using Special Paper

Always test paper samples before purchasing them to ensure desirable performance.

- DO NOT use inkjet paper; it may cause a paper jam or damage your machine.
- If you use bond paper, paper with a rough surface, or paper that is wrinkled or creased, the paper may exhibit degraded performance.

Store paper in its original packaging and keep it sealed. Keep the paper flat and away from moisture, direct sunlight and heat.

### IMPORTANT

Some types of paper may not perform well or may cause damage to your machine.

DO NOT use paper:

- that is highly textured
- that is extremely smooth or shiny
- that is curled or warped
- that is coated or has a chemical finish
- that is damaged, creased or folded
- that exceeds the recommended weight specification in this guide
- with tabs and staples
- with letterheads using low temperature dyes or thermography
- that is multipart or carbonless
- that is designed for inkjet printing

If you use any of the types of paper listed above, they may damage your machine. This damage is not covered under any Brother warranty or service agreement.



### Related Information

- [Paper Handling](#)

## Print

- [Print from Your Computer \(Windows®\)](#)
- [Print from Your Computer \(Mac\)](#)
- [Cancel a Print Job](#)
- [Test Print](#)

## **Print from Your Computer (Windows®)**

- [Print a Document \(Windows®\)](#)
- [Print Settings \(Windows®\)](#)
- [Change the Default Print Settings \(Windows®\)](#)
- [Monitor the Status of the Machine from Your Computer \(Windows®\)](#)

## Print a Document (Windows®)

1. Select the print command in your application.
2. Select **Brother XXX-XXXX** (where XXXX is the name of your model), and then click the printing properties or preferences button.

The printer driver window appears.

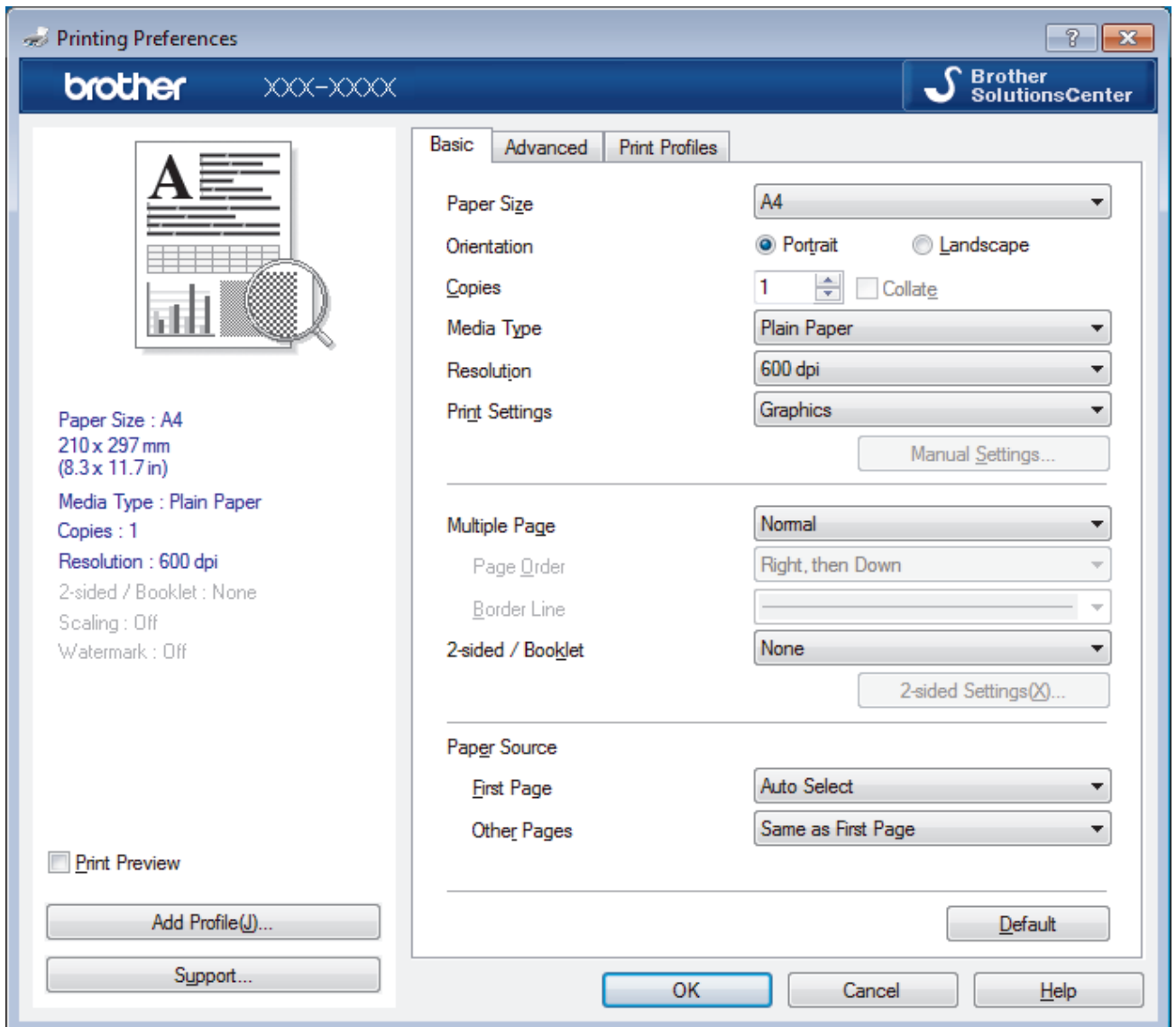

3. Make sure you have loaded the correct size paper in the paper tray.
4. Click the **Paper Size** drop-down list, and then select your paper size.
5. In the **Orientation** field, select the **Portrait** or **Landscape** option to set the orientation of your printout.



If your application contains a similar setting, we recommend that you set the orientation using the application.

6. Type the number of copies (1-999) you want in the **Copies** field.
7. Click the **Media Type** drop-down list, and then select the type of paper you are using.
8. To print multiple pages on a single sheet of paper or print one page of your document on multiple sheets, click the **Multiple Page** drop-down list, and then select your options.
9. Change other printer settings if needed.
10. Click **OK**.
11. Complete your print operation.



---

## Related Information

---

- [Print from Your Computer \(Windows®\)](#)
  - [Print Settings \(Windows®\)](#)
-

## Print Settings (Windows®)

### Basic Tab

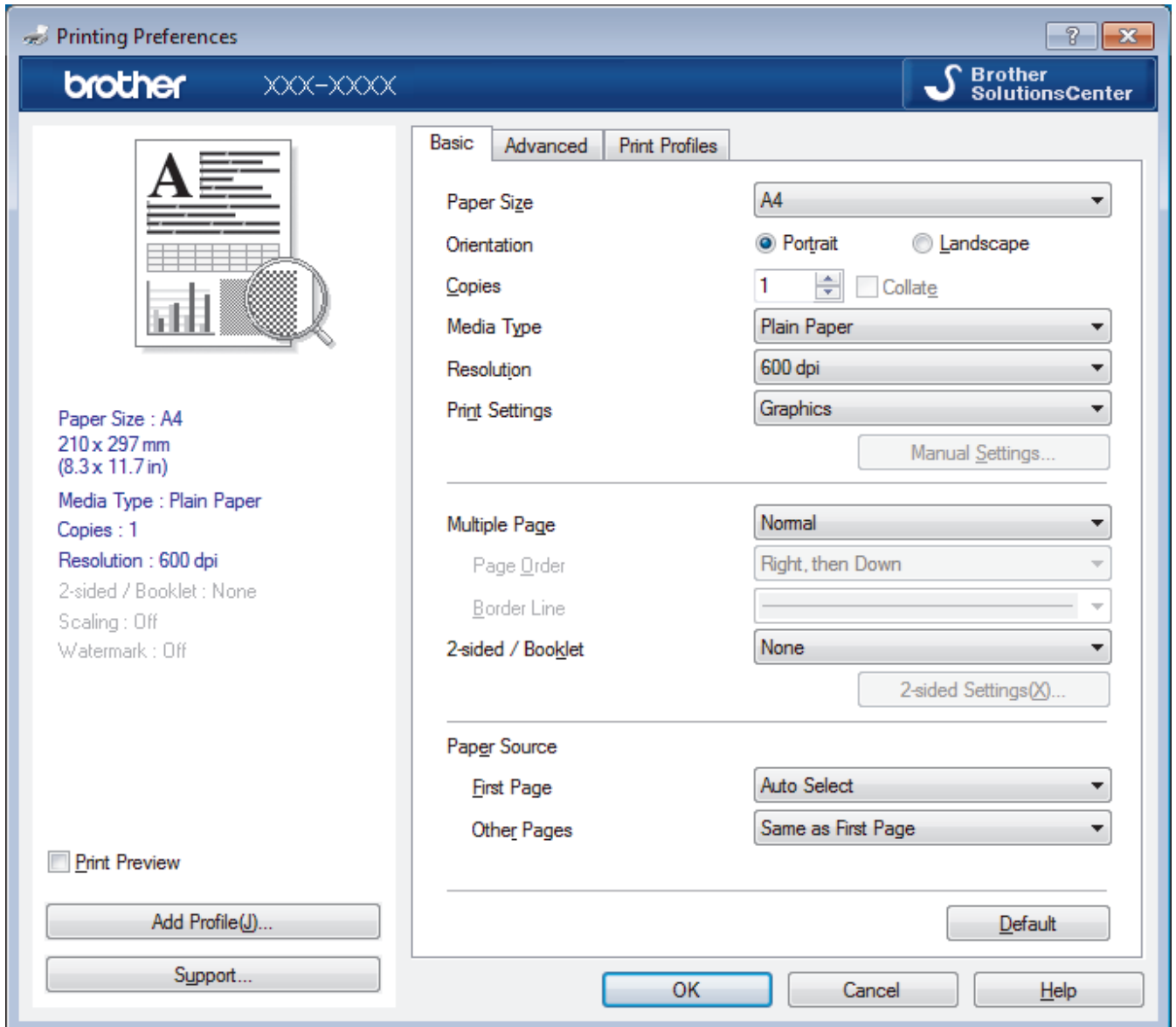

#### 1. Paper Size

Select the size of the paper you want to use. You can either choose from standard paper sizes or create a custom paper size.

#### 2. Orientation

Select the orientation (portrait or landscape) of your printout.

If your application contains a similar setting, we recommend that you set the orientation using the application.

#### 3. Copies

Type the number of copies (1-999) that you want to print in this field.

#### Collate

Select this option to print sets of multi-page documents in the original page order. When this option is selected, one complete copy of your document will print, and then reprint according to the number of copies you choose. If this option is not selected, then each page will print according to the number of copies chosen before the next page of the document is printed.

#### 4. Media Type

Select the type of media you want to use. To achieve the best print results, the machine automatically adjusts its print settings according to the selected media type.

---

## 5. Resolution

Select the print resolution. As print resolution and speed are related, the higher the resolution, the longer it will take to print the document.

## 6. Print Settings

Select the type of document you want to print.

### Manual Settings...

Specify advanced settings such as brightness, contrast, and other settings.

### Graphics

#### Use Printer Halftone

Select this option to use the printer driver to express halftones.

#### Brightness

Specify the brightness.

#### Contrast

Specify the contrast.

#### Graphics Quality

Select either Graphics or Text for the best print quality, based on the type of document you are printing.

#### Improve Grey Printing

Select this option to improve the image quality of shaded areas.

#### Improve Pattern Printing

Select this option to improve the pattern printing if printed fills and patterns are different from the fills and patterns you see on your computer screen.

#### Improve Thin Line

Select this option to improve the image quality of thin lines.

#### Use System Halftone

Select this option to use Windows® to express halftones.

### TrueType Mode (Available only for certain models)

#### Mode

Select how the fonts are processed for printing.

#### Use Printer TrueType Fonts

Select whether to use built-in fonts for the font processing.

## 7. Multiple Page

Select this option to print multiple pages on a single sheet of paper or print one page of your document on multiple sheets.

### Page Order

Select the page order when printing multiple pages on a single sheet of paper.

### Border Line

Select the type of border to use when printing multiple pages on a single sheet of paper.

## 8. 2-sided / Booklet

Select this option to print on both sides of the paper or print a document in booklet format using 2-sided printing.

### 2-sided Settings button

Click this button to select the type of 2-sided binding. Four types of 2-sided bindings are available for each orientation.



## 9. Paper Source

Select the paper source setting according to your print conditions or purpose.

### First Page

Select the paper source to use for printing the first page.

### Other Pages

Select the paper source to use for printing the second and subsequent pages.

## Advanced Tab

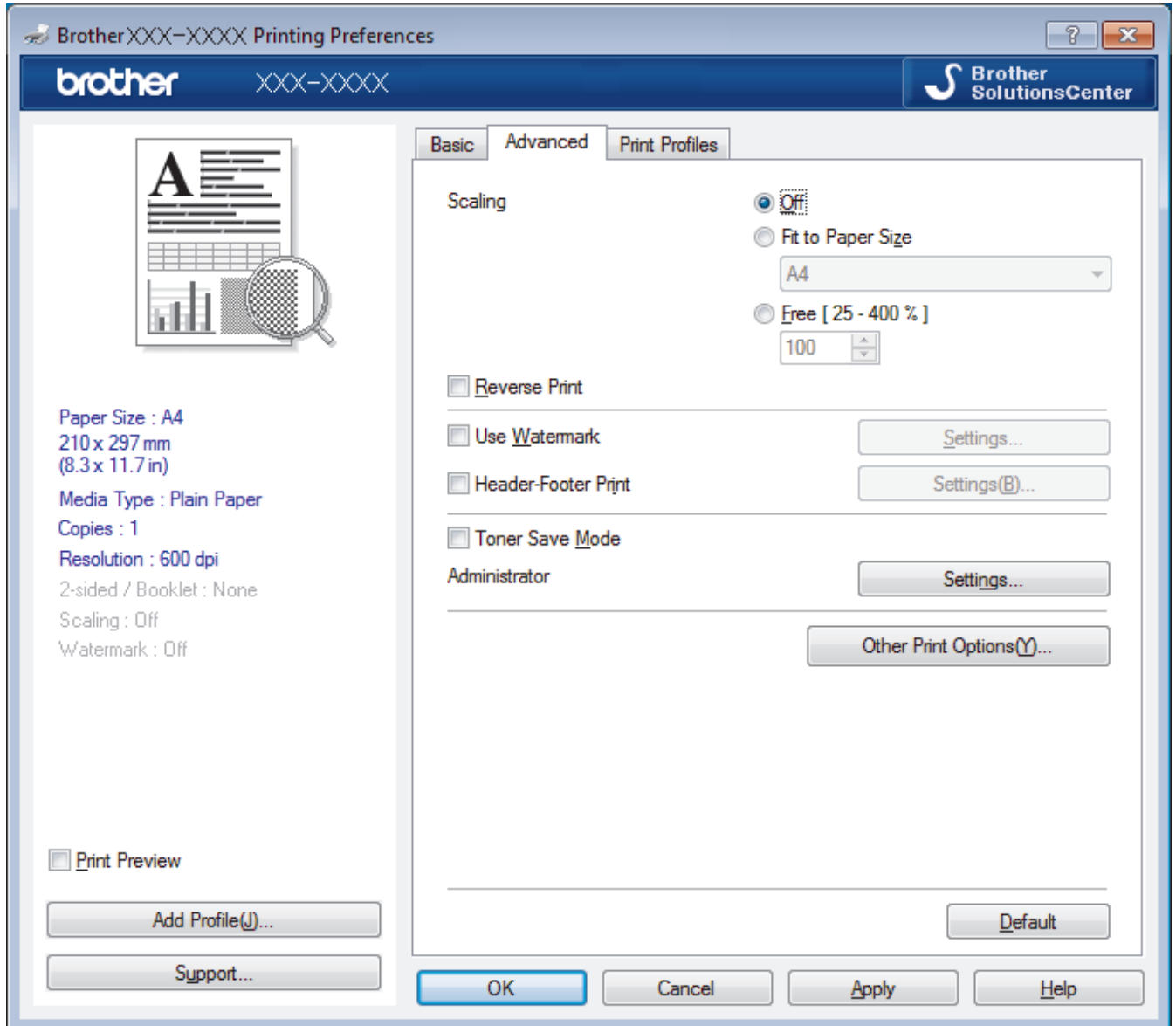

### 1. Scaling

Select these options to enlarge or reduce the size of the pages in your document.

#### Fit to Paper Size

Select this option to enlarge or reduce the document pages to fit a specified paper size. When you select this option, select the paper size you want from the drop-down list.

#### Free [25 - 400%]

Select this option to enlarge or reduce the document pages manually. When you select this option, type a value into the field.

### 2. Reverse Print

Select this option to rotate the printed image 180 degrees.

---

### 3. Use Watermark

Select this option to print a logo or text on your document as a watermark. Select one of the preset watermarks, add a new watermark, or use an image file you have created.

### 4. Header-Footer Print

Select this option to print the date, time and PC login user name on the document.

### 5. Toner Save Mode

Select this feature to conserve toner by using less toner to print documents; printouts appear lighter, but are still legible.

### 6. Administrator

This feature allows you to change the administrator password and restrict various printing functions.

### 7. User Authentication (Available only for certain models)

This feature allows you to confirm the restrictions for each user.

### 8. Other Print Options button

#### Sleep Time

Select this option to set the machine to enter sleep mode immediately after printing.

#### Macro (Available only for certain models)

Select this feature to print an electronic form (macro), which you have stored in your machine's memory, as an overlay on the print job.

#### Density Adjustment

Specify the print density.

#### Improve Print Output

Select this option to reduce the amount of paper curling and improve the toner fixing.

#### Skip Blank Page

Select this option to allow the printer driver to automatically detect blank pages and exclude them from printing.

#### Print Text in Black

Select this option when you want to print colour text in black.

#### Print Archive

Select this option to save the print data as a PDF file to your computer.

#### Eco settings

Select this option to reduce printing noise.



### Related Information

- [Print from Your Computer \(Windows®\)](#)
  - [Print a Document \(Windows®\)](#)
-

## Change the Default Print Settings (Windows®)

When you change an application's print settings, the changes only apply to documents printed with that application. To change print settings for all Windows® applications, you must configure the printer driver properties.

1. Do one of the following:

- For Windows Server® 2008

Click  (**Start**) > **Control Panel** > **Hardware and Sound** > **Printers**.

- For Windows® 7 and Windows Server® 2008 R2

Click  (**Start**) > **Devices and Printers**.

- For Windows® 8

Move your mouse to the lower right corner of your desktop. When the menu bar appears, click **Settings**, and then click **Control Panel**. In the **Hardware and Sound** group, click **View devices and printers**.

- For Windows® 10 and Windows Server® 2016

Click  > **Windows System** > **Control Panel**. In the **Hardware and Sound** group, click **View devices and printers**.

- For Windows Server® 2012

Move your mouse to the lower right corner of your desktop. When the menu bar appears, click **Settings**, and then click **Control Panel**. In the **Hardware** group, click **View devices and printers**.

- For Windows Server® 2012 R2

Click **Control Panel** on the **Start** screen. In the **Hardware** group, click **View devices and printers**.

2. Right-click the **Brother XXX-XXXX** icon (where XXXX is your model name), and then select **Printer properties**. If printer driver options appear, select your printer driver.

3. Click the **General** tab, and then click the **Printing Preferences...** or **Preferences...** button.

The printer driver dialog box appears.



- To configure the tray settings, click the **Device Settings** tab (Available only for certain models).
- To change the printer port, click the **Ports** tab.

4. Select the print settings you want to use as defaults for all of your Windows® programs.

5. Click **OK**.

6. Close the printer properties dialog box.



### Related Information

- [Print from Your Computer \(Windows®\)](#)

## Monitor the Status of the Machine from Your Computer (Windows®)

The Status Monitor utility is a configurable software tool for monitoring the status of one or more devices, allowing you to get immediate notification of errors.

• Do one of the following:

- Double-click the  icon in the task tray.
- (Windows® 7, Windows Server® 2008 and Windows Server® 2008 R2)



Click  (**Start**) > **All Programs** > **Brother** > **Brother Utilities**.

Click the drop-down list and select your model name (if not already selected). Click **Tools** in the left navigation bar, and then click **Status Monitor**.

- (Windows® 8 and Windows Server® 2012)

Click  (**Brother Utilities**), and then click the drop-down list and select your model name (if not already selected). Click **Tools** in the left navigation bar, and then click **Status Monitor**.

- (Windows® 8.1 and Windows Server® 2012 R2)

Move your mouse to the lower left corner of the **Start** screen and click  (if you are using a touch-based device, swipe up from bottom of the **Start** screen to bring up the **Apps** screen). When the **Apps** screen appears, tap or click  (**Brother Utilities**), and then click the drop-down list and select your model name (if not already selected). Click **Tools** in the left navigation bar, and then click **Status Monitor**.

- (Windows® 10 and Windows Server® 2016)

Click  > **Brother** > **Brother Utilities**.

Click the drop-down list and select your model name (if not already selected). Click **Tools** in the left navigation bar, and then click **Status Monitor**.

### Troubleshooting

Click the **Troubleshooting** button to access the troubleshooting website.

### Looking for replacement supplies?

Click the **Looking for replacement supplies?** button for more information on Brother genuine supplies.



### Related Information

- [Print from Your Computer \(Windows®\)](#)
- [Printing Problems](#)

## **Print from Your Computer (Mac)**

- [Print a Document \(Mac\)](#)
- [Print Options \(Mac\)](#)
- [Monitor the Status of the Machine from Your Computer \(Mac\)](#)

## Print a Document (Mac)

1. Make sure you have loaded the correct size paper in the paper tray.
2. From an application, such as Apple TextEdit, click the **File** menu, and then select **Print**.
3. Select **Brother XXX-XXXX** (where XXXX is your model name).
4. Type the number of copies you want in the **Copies** field.
5. Click the **Paper Size** pop-up menu, and then select your paper size.
6. Select the **Orientation** option that matches the way you want the document to print.
7. Click the application pop-up menu, and then select **Print Settings**.

The **Print Settings** options appear.

8. Click the **Media Type** pop-up menu, and then select the type of paper you are using.
9. Change other printer settings, if needed.
10. Click **Print**.



### Related Information

- [Print from Your Computer \(Mac\)](#)
  - [Print Options \(Mac\)](#)
-

## Print Options (Mac)

### Page Setup

Settings: **Page Attributes**

Format For: **XXX-XXXX**  
Brother XXX-XXXX CUPS

Paper Size: **A4**  
210 by 297 mm

Orientation:  Portrait  Landscape

Scale: **100** %

? Cancel OK

#### 1. Paper Size

Select the size of the paper you want to use. You can either choose from standard paper sizes or create a custom paper size.

#### 2. Orientation

Select the orientation (portrait or landscape) of your printout.

If your application contains a similar setting, we recommend that you set the orientation using the application.

#### 3. Scale

Type a value into the field to enlarge or reduce the pages in your document to fit the selected paper size.

## Layout

Printer: XXX-XXXX

Presets: Default Settings

Copies: 1  Two-Sided

Pages:  All  
 From: 1 to: 1

Paper Size: A4 210 by 297 mm

Orientation:

Layout

Pages per Sheet: 1

Layout Direction:

Border: None

Two-Sided: Off

Reverse page orientation  
 Flip horizontally

? PDF Hide Details Cancel Print

### 1. Pages per Sheet

Select the number of pages to print on a single sheet of paper.

### 2. Layout Direction

Select the page order when printing multiple pages on a single sheet of paper.

### 3. Border

Select the type of border to use when printing multiple pages on a single sheet of paper.

### 4. Two-Sided

Select whether to print on both sides of the paper.

### 5. Reverse page orientation

Select this option to rotate the printed image 180 degrees.

### 6. Flip horizontally

Select this option to reverse the printed image on the page horizontally from left to right.



## Paper Handling

Printer: XXX-XXXX

Presets: Default Settings

Copies: 1  Two-Sided

Pages:  All  
 From: 1 to: 1

Paper Size: A4 210 by 297 mm

Orientation:

Paper Handling

Collate pages

Pages to Print: All pages

Page Order: Automatic

Scale to fit paper size

Destination Paper Size: Suggested Paper: A4

Scale down only

? PDF Hide Details Cancel Print

### 1. Collate pages

Select this option to print sets of multi-page documents in the original page order. When this option is selected, one complete copy of your document will print, and then reprint according to the number of copies you choose. If this option is not selected, then each page will print according to the number of copies chosen before the next page of the document is printed.

### 2. Pages to Print

Select which pages you want to print (even pages or odd pages).

### 3. Page Order

Select the page order.

### 4. Scale to fit paper size

Select this option to enlarge or reduce the pages in your document to fit the selected paper size.

### 5. Destination Paper Size

Select the paper size to print on.

### 6. Scale down only

Select this option if you want to reduce the pages in your document when they are too large for the selected paper size. If this option is selected and the document is formatted for a paper size that is smaller than the paper size you are using, the document will be printed at its original size.

## Print Settings

Printer: XXX-XXXX

Presets: Default Settings

Copies: 1  Two-Sided

Pages:  All  
 From: 1 to: 1

Paper Size: A4 210 by 297 mm

Orientation:  Portrait  Landscape

---

Print Settings

Media Type: Plain Paper

Print Quality: 600 dpi

Paper Source: Auto Select

► Advanced

? PDF Hide Details Cancel Print

### 1. Media Type

Select the type of media you want to use. To achieve the best print results, the machine automatically adjusts its print settings according to the selected media type.

### 2. Print Quality

Select the print resolution you want. Because print quality and speed are related, the higher the quality, the longer it will take to print the document.

### 3. Paper Source

Select the paper source setting according to your print conditions or purpose.

### 4. Advanced

#### Toner Save Mode

Select this feature to conserve toner by using less toner to print documents; printouts appear lighter, but are still legible.

#### Graphics Quality

Select either Graphics or Text for the best print quality, based on the type of document you are printing.

#### Improve Print Output

Select this option to reduce the amount of paper curling and improve the toner fixing.

#### Density Adjustment

Specify the print density.

#### Sleep Time

Specify the amount of time that passes before the machine enters Sleep Mode.

#### Quiet Mode

Select this option to reduce printing noise.

---

## Other Print Options

### Skip Blank Page

Select this option to allow the printer driver to automatically detect blank pages and exclude them from printing.



### Related Information

- [Print from Your Computer \(Mac\)](#)
  - [Print a Document \(Mac\)](#)
-

## Monitor the Status of the Machine from Your Computer (Mac)

The Status Monitor utility is a configurable software tool for monitoring the status of a device, allowing you to get immediate notification of error messages, such as paper empty or paper jam, at preset update intervals. You can also access Web Based Management.

1. Click the **System Preferences** menu, select **Print & Scan** or **Printers & Scanners**, and then select your machine.
2. Click the **Options & Supplies** button.
3. Click the **Utility** tab, and then click the **Open Printer Utility** button.

Status Monitor starts.

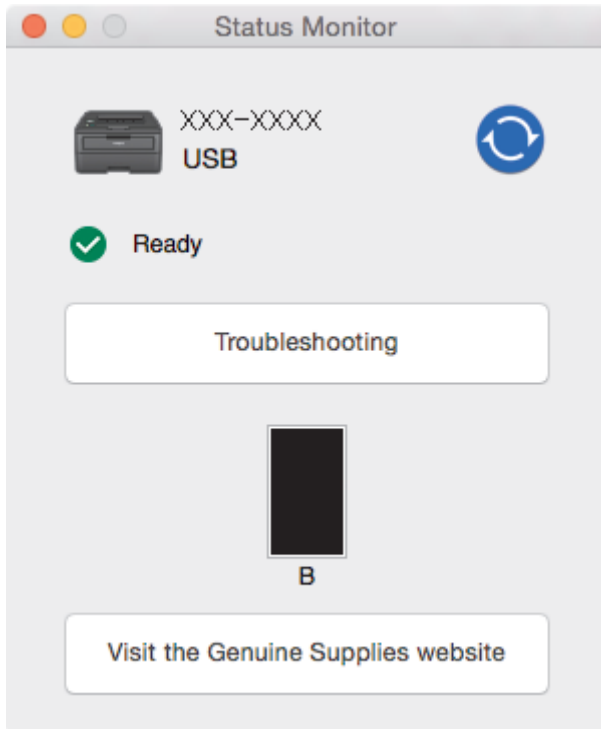

### Troubleshooting

Click the **Troubleshooting** button to access the troubleshooting website.

### Visit the Genuine Supplies website

Click the **Visit the Genuine Supplies website** button for more information on Brother genuine supplies.

### Updating the machine's status

To view the latest machine status while the **Status Monitor** window is open, click the  icon. You can set the interval at which the software updates machine status information. Click **Brother Status Monitor** in the menu bar, and then select **Preferences**.

### Web Based Management (Network Connection Only)

Access the Web Based Management System by clicking the machine icon on the **Status Monitor** screen. You can use a standard Web Browser to manage your machine using HTTP (Hyper Text Transfer Protocol).

## ✓ Related Information

- [Print from Your Computer \(Mac\)](#)
- [Printing Problems](#)

## Cancel a Print Job

1. On the machine's control panel, press and hold **Go** for about two seconds to cancel the current print job.



To cancel multiple print jobs, press and hold **Go** for six seconds.



### Related Information

- [Print](#)
  - [Printing Problems](#)
-

## Test Print

**Related Models:** HL-L2350DW/HL-L2357DW/HL-L2370DN/HL-L2375DW

If there are problems with print quality, follow these instructions to do a test print:

1. Press ▲ or ▼ to display the [Printer] option, and then press **OK**.
2. (HL-L2370DN/HL-L2375DW)  
Press ▲ or ▼ to display the [Print Options] option, and then press **OK**.
3. Press ▲ or ▼ to display the [Test Print] option, and then press **Go**.

The machine prints the test page.



### Related Information

- [Print](#)
- [Improve the Print Quality](#)

## Network

- [Supported Basic Network Features](#)
- [Network Management Software and Utilities](#)
- [Additional Methods of Configuring Your Brother Machine for a Wireless Network](#)
- [Advanced Network Features](#)
- [Technical Information for Advanced Users](#)

## Supported Basic Network Features

**Related Models:** HL-L2350DW/HL-L2357DW/HL-L2370DN/HL-L2375DW

The print server supports various features depending on the operating system. Use this table to see which network features and connections are supported by each operating system.

Operating Systems	Windows® 7 Windows® 8 Windows® 10	Windows Server® 2008/2008 R2/2012/2012 R2/2016	macOS v10.10.5 macOS v10.11.x macOS v10.12.x
Printing	Yes	Yes	Yes
BRAdmin Light	Yes	Yes	
BRAdmin Professional	Yes	Yes	
Web Based Management	Yes	Yes	Yes
Status Monitor	Yes		Yes
Driver Deployment Wizard	Yes	Yes	
Vertical Pairing	Yes		



- Go to your model's **Downloads** page on the Brother Solutions Center at [support.brother.com](http://support.brother.com) to download the latest version of Brother's BRAdmin Light.
- Go to your model's **Downloads** page on the Brother Solutions Center at [support.brother.com](http://support.brother.com) to download the latest version of Brother's BRAdmin Professional utility.



### Related Information

- [Network](#)



## Network Management Software and Utilities

Configure and change your Brother machine's network settings using a management utility.

- [Learn about Network Management Software and Utilities](#)
- [Change Machine Settings from Your Computer](#)
- [Change Machine Settings Using Web Based Management](#)

## Learn about Network Management Software and Utilities

**Related Models:** HL-L2350DW/HL-L2357DW/HL-L2370DN/HL-L2375DW

### Web Based Management

Web Based Management is a utility that uses a standard web browser to manage your machine using the Hyper Text Transfer Protocol (HTTP) or Hyper Text Transfer Protocol over Secure Socket Layer (HTTPS). Type your machine's IP address into your web browser to access and change your print server settings.

### BRAdmin Light (Windows®)

BRAdmin Light is a utility for the initial setup of Brother network-connected devices. This utility can search for Brother products on your network, view the status and configure the basic network settings, such as IP address.

Go to your model's **Downloads** page on the Brother Solutions Center at [support.brother.com](http://support.brother.com) to download BRAdmin Light.



- If using Windows® Firewall, or the firewall function of an anti-spyware or antivirus application, temporarily disable them. When you are sure you can print, configure the software settings following the instructions.

### BRAdmin Professional (Windows®)

BRAdmin Professional is a utility for more advanced management of network-connected Brother devices. This utility can search for Brother products on your network and view the device status from an easy-to-read Windows® Explorer-style screen that changes colour to identify the status of each device. You can configure network and device settings, and update device firmware from a Windows® computer on your LAN. BRAdmin Professional can also log activity of Brother devices on your network and export the log data. For users who want to monitor locally-connected machines, install the Print Auditor Client software on the client computer. This utility allows you to use BRAdmin Professional to monitor machines that are connected to a client computer via the USB interface.



- Go to your model's **Downloads** page on the Brother Solutions Center at [support.brother.com](http://support.brother.com) to download the latest version of Brother's BRAdmin Professional utility.
- Node name: The node name appears in the current BRAdmin Professional window. The default node name is "BRNxxxxxxxxxxx" for a wired network or "BRWxxxxxxxxxxx" for a wireless network (where "xxxxxxxxxxx" is your machine's MAC Address / Ethernet address).
- If using Windows® Firewall, or the firewall function of an anti-spyware or antivirus application, temporarily disable them. When you are sure you can print, configure the software settings following the instructions.



### Related Information

- [Network Management Software and Utilities](#)

## Additional Methods of Configuring Your Brother Machine for a Wireless Network

To connect your machine to your wireless network, we recommend using the Brother installation disc.

- [Before Configuring Your Brother Machine for a Wireless Network](#)
- [Configure Your Machine for a Wireless Network](#)
- [Configure Your Machine for a Wireless Network Using the One Push Method of Wi-Fi Protected Setup™ \(WPS\)](#)
- [Configure Your Machine for a Wireless Network Using the PIN Method of Wi-Fi Protected Setup™ \(WPS\)](#)
- [Configure Your Machine for a Wireless Network Using the Machine's Control Panel Setup Wizard](#)
- [Configure Your Machine for a Wireless Network When the SSID Is Not Broadcast](#)
- [Use Wi-Fi Direct®](#)

## Before Configuring Your Brother Machine for a Wireless Network

**Related Models:** HL-L2350DW/HL-L2357DW/HL-L2375DW

Before attempting to configure a wireless network, confirm the following:

- To achieve optimum results with normal everyday document printing, place the Brother machine as close to the wireless LAN access point/router as possible with minimal obstructions. Large objects and walls between the two devices and interference from other electronic devices can affect the data transfer speed of your documents.

Due to these factors, wireless may not be the best method of connection for all types of documents and applications. If you are printing large files, such as multi-page documents with mixed text and large graphics, you may want to consider selecting wired Ethernet for faster data transfer (supported models only), or USB for the fastest throughput speed.

- Although the Brother machine can be used in both a wired and wireless network (supported models only), only one connection method can be used at a time. However, a wireless network connection and Wi-Fi Direct connection, or a wired network connection (supported models only) and Wi-Fi Direct connection can be used at the same time.



If you do not know the security information, please consult the router manufacturer, your system administrator, or your Internet provider.



### Related Information

- [Additional Methods of Configuring Your Brother Machine for a Wireless Network](#)

## Configure Your Machine for a Wireless Network

**Related Models:** HL-L2350DW/HL-L2357DW/HL-L2375DW

1. Turn on your computer and insert the Brother installation disc into your computer.
  - For Windows®, follow these instructions:
  - For Mac, click **Driver Download** to go to the Brother Solutions Center. Follow the on-screen instructions to install printer drivers.
2. The opening screen appears automatically.  
Choose your language, and then follow the on-screen instructions.



If the Brother screen does not appear, do the following:

- (Windows® 7)  
Go to **Computer**. Double-click the CD/DVD icon, and then double-click **start.exe**.
- (Windows® 8 and Windows® 10)  
Click the  (**File Explorer**) icon on the taskbar, and then go to **Computer (This PC)**. Double-click the CD/DVD icon, and then double-click **start.exe**.
- If the **User Account Control** screen appears, click **Yes**.

3. Choose **Wireless Network Connection (Wi-Fi)**, and then click **Next**.
4. Follow the on-screen instructions.

You have completed the wireless network setup. To install **Full Driver & Software Package** necessary for operating your device, insert the Brother installation disc into your computer or go to your model's **Downloads** page on the Brother Solutions Center at [support.brother.com](http://support.brother.com).



### Related Information

- [Additional Methods of Configuring Your Brother Machine for a Wireless Network](#)

## Configure Your Machine for a Wireless Network Using the One Push Method of Wi-Fi Protected Setup™ (WPS)

**Related Models:** HL-L2350DW/HL-L2357DW/HL-L2375DW

If your wireless access point/router supports WPS (PBC: Push Button Configuration), you can use WPS from your machine's control panel menu to configure your wireless network settings.



Routers or access points that support WPS are marked with this symbol:



1. Press ▲ or ▼ to select the [Network] option, and then press **OK**.
2. Press ▲ or ▼ to select the [WLAN] option, and then press **OK**.
3. Press ▲ or ▼ to select the [WPS] option, and then press **OK**.
4. When [WLAN Enable?] appears, press ▼ to select On.  
This will start the wireless setup wizard. To cancel, press ▲.
5. When the LCD displays [Press Key on rtr], press the WPS button on your wireless access point/router. Press ▲ on the machine's control panel. Your machine will automatically detect your wireless access point/router and try to connect to your wireless network.

If your wireless device is connected successfully, the machine's LCD displays [Connected].

You have completed the wireless network setup. To install **Full Driver & Software Package** necessary for operating your device, insert the Brother installation disc into your computer or go to your model's **Downloads** page on the Brother Solutions Center at [support.brother.com](http://support.brother.com).



### Related Information

- [Additional Methods of Configuring Your Brother Machine for a Wireless Network](#)
- [Wireless LAN Report Error Codes](#)

## Configure Your Machine for a Wireless Network Using the PIN Method of Wi-Fi Protected Setup™ (WPS)

**Related Models:** HL-L2350DW/HL-L2357DW/HL-L2375DW

If your wireless LAN access point/router supports WPS, you can use the Personal Identification Number (PIN) Method to configure your wireless network settings.

The PIN Method is one of the connection methods developed by the Wi-Fi Alliance®. By submitting a PIN created by an Enrollee (your machine) to the Registrar (a device that manages the wireless LAN), you can set up the wireless network and security settings. For more information on how to access WPS mode, see the instructions provided with your wireless access point/router.

### Type A

Connection when the wireless LAN access point/router (1) doubles as the Registrar:

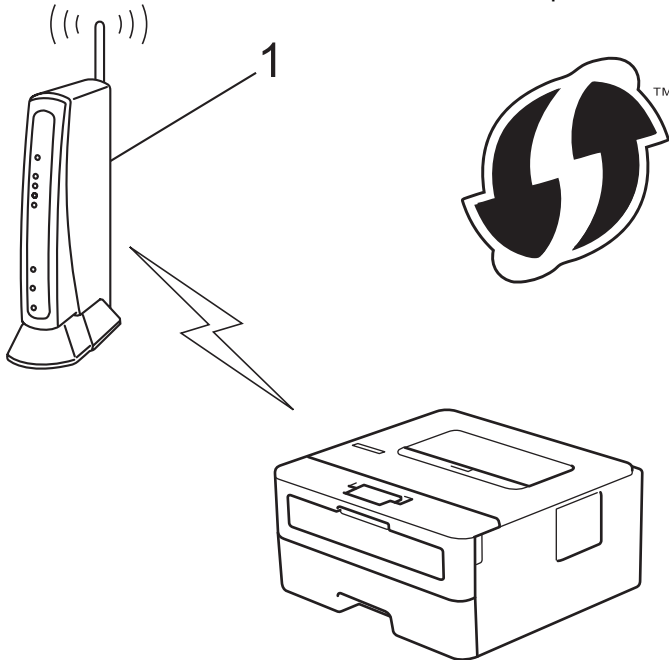

### Type B

Connection when another device (2), such as a computer, is used as the Registrar:

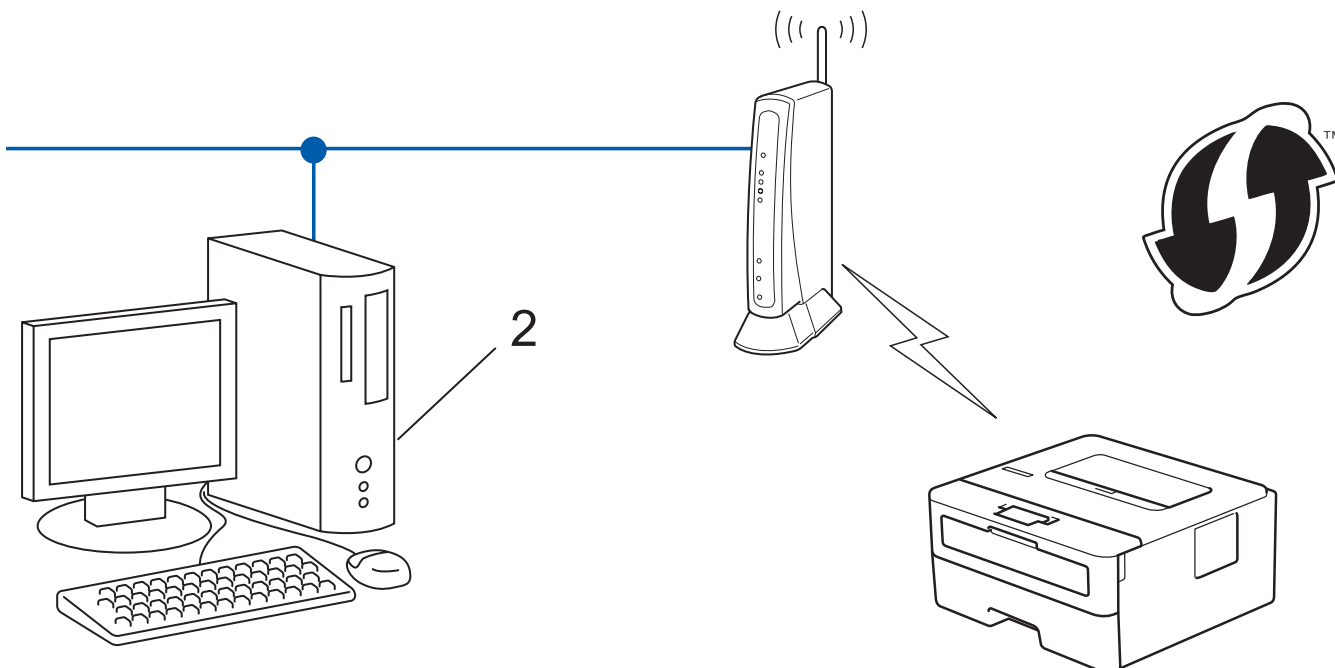

 Routers or access points that support WPS are marked with this symbol:



1. Press ▲ or ▼ to select the [Network] option, and then press **OK**.
2. Press ▲ or ▼ to select the [WLAN] option, and then press **OK**.
3. Press ▲ or ▼ to select the [WPS w/PIN Code] option, and then press **OK**.
4. When [WLAN Enable?] appears, press ▼ to select On.  
This will start the wireless setup wizard. To cancel, press ▲.
5. The LCD displays an eight-digit PIN and the machine starts searching for a wireless LAN access point/router.
6. Using a computer connected to the network, in your browser's address bar, type the IP address of the device you are using as the Registrar. (For example: <http://192.168.1.2>)
7. Go to the WPS settings page and type the PIN, and then follow the on-screen instructions.

- 
- The Registrar is usually the wireless LAN access point/router.
  - The settings page will differ depending on the brand of wireless LAN access point/router. For more information, see the instructions supplied with your wireless LAN access point/router.

**If you are using a Windows® 7, Windows® 8, or Windows® 10 computer as a Registrar, complete the following steps:**

8. Do one of the following:
  - Windows® 7  
Click  (**Start**) > **Devices and Printers** > **Add a device**.
  - Windows® 8  
Move your mouse to the lower right corner of your desktop. When the menu bar appears, click **Settings** > **Control Panel** > **Hardware and Sound** > **View devices and printers** > **Add a device**.
  - Windows® 10



---

Click  > **Windows System** > **Control Panel**. In the **Hardware and Sound** group, click **Add a device**.



- To use a Windows® 7, Windows® 8, or Windows® 10 computer as a Registrar, you must register it to your network in advance. For more information, see the instructions supplied with your wireless LAN access point/router.
- If you use Windows® 7, Windows® 8, or Windows® 10 as a Registrar, you can install the printer driver after the wireless configuration by following the on-screen instructions. To install the full driver and software package, use the Brother installation disc.

- 
9. Select your machine and click **Next**.
  10. Type the PIN displayed on the machine's LCD, and then click **Next**.
  11. (Windows® 7) Select your network, and then click **Next**.
  12. Click **Close**.

If your wireless device is connected successfully, the machine's LCD displays [Connected].

You have completed the wireless network setup. To install **Full Driver & Software Package** necessary for operating your device, insert the Brother installation disc into your computer or go to your model's **Downloads** page on the Brother Solutions Center at [support.brother.com](http://support.brother.com).



### Related Information

- [Additional Methods of Configuring Your Brother Machine for a Wireless Network](#)
  - [Wireless LAN Report Error Codes](#)
-

## Configure Your Machine for a Wireless Network Using the Machine's Control Panel Setup Wizard

**Related Models:** HL-L2350DW/HL-L2357DW/HL-L2375DW

Before configuring your machine, we recommend writing down your wireless network settings. You will need this information before you continue with the configuration.

1. Check and record the current wireless network settings of the computer to which you are connecting.

Network Name (SSID)

Network Key

For example:

Network Name (SSID)
HELLO

Network Key
12345



- Your access point/router may support the use of multiple WEP keys, however your Brother machine supports the use of the first WEP key only.
- If you need assistance during setup and want to contact Brother customer service, make sure you have your SSID (Network Name) and Network Key ready. We cannot assist you in locating this information.
- If you do not know this information (SSID and Network Key), you cannot continue the wireless setup.

### How can I find this information?

- Check the documentation provided with your wireless access point/router.
- The initial SSID could be the manufacturer's name or the model name.
- If you do not know the security information, please consult the router manufacturer, your system administrator, or your Internet provider.

2. Press **▲** or **▼** to select the [Network] option, and then press **OK**.
3. Press **▲** or **▼** to select the [WLAN] option, and then press **OK**.
4. Press **▲** or **▼** to select the [Setup Wizard] option, and then press **OK**.
5. When [WLAN Enable?] appears, press **▼** to select On.  
This will start the wireless setup wizard. To cancel, press **▲**.
6. The machine will search for your network and display a list of available SSIDs. When a list of SSIDs appears, press **▲** or **▼** to select the SSID you want.
7. Press **OK**.
8. Do one of the following:
  - If you are using an authentication and encryption method that requires a Network Key, enter the Network Key you wrote down in the first step.  
Enter the key, and then press **OK** to apply your settings.  
To apply the settings, press **▼**. To cancel, press **▲**.

- 
- If your authentication method is Open System and your encryption mode is None, go to the next step.
9. The machine attempts to connect to the wireless device you have selected.

If your wireless device is connected successfully, the machine's LCD displays [Connected].

You have completed the wireless network setup. To install **Full Driver & Software Package** necessary for operating your device, insert the Brother installation disc into your computer or go to your model's **Downloads** page on the Brother Solutions Center at [support.brother.com](http://support.brother.com).



### Related Information

- [Additional Methods of Configuring Your Brother Machine for a Wireless Network](#)
  - [How to Enter Text on Your Brother Machine](#)
  - [Wireless LAN Report Error Codes](#)
-

## Configure Your Machine for a Wireless Network When the SSID Is Not Broadcast

**Related Models:** HL-L2350DW/HL-L2357DW/HL-L2375DW

Before configuring your machine, we recommend writing down your wireless network settings. You will need this information before you continue with the configuration.

1. Check and write down the current wireless network settings.

Network Name (SSID)				
Communication Mode	Authentication Method	Encryption Mode	Network Key	
Infrastructure	Open System	NONE	-	
		WEP		
	Shared Key	WEP		
		WPA/WPA2-PSK	AES	
			TKIP	

For example:

Network Name (SSID)			
HELLO			
Communication Mode	Authentication Method	Encryption Mode	Network Key
Infrastructure	WPA2-PSK	AES	12345678



If your router uses WEP encryption, enter the key used as the first WEP key. Your Brother machine supports the use of the first WEP key only.

2. Press **▲** or **▼** to select the [Network] option, and then press **OK**.
3. Press **▲** or **▼** to select the [WLAN] option, and then press **OK**.
4. Press **▲** or **▼** to select the [Setup Wizard] option, and then press **OK**.
5. When [WLAN Enable?] appears, press **▼** to select On.  
This will start the wireless setup wizard. To cancel, press **▲**.
6. The machine will search for your network and display a list of available SSIDs. Press **▲** or **▼** to select the [<New SSID>] option, and then press **OK**.
7. Enter the SSID name, and then press **OK**.
8. Select the [Infrastructure] option, and then press **OK**.
9. Press **▲** or **▼** to select the Authentication Method you want, and then press **OK**.
10. Do one of the following:
  - If you selected the [Open System] option, press **▲** or **▼** to select the Encryption Type [None] or [WEP], and then press **OK**.  
If you selected the [WEP] option for Encryption Type, enter the WEP key, and then press **OK**.
  - If you selected the [Shared Key] option, enter the WEP key, and then press **OK**.
  - If you selected the [WPA/WPA2-PSK] option, press **▲** or **▼** to select the Encryption Type [TKIP+AES] or [AES], and then press **OK**.

---

Enter the WPA™ key, and then press **OK**.



Your Brother machine supports the use of the first WEP key only.

11. To apply the settings, press ▼. To cancel, press ▲.
12. The machine will attempt to connect to the wireless device you have selected.

If your wireless device is connected successfully, the machine's LCD displays [Connected].

You have completed the wireless network setup. To install **Full Driver & Software Package** necessary for operating your device, insert the Brother installation disc into your computer or go to your model's **Downloads** page on the Brother Solutions Center at [support.brother.com](http://support.brother.com).



### Related Information

- [Additional Methods of Configuring Your Brother Machine for a Wireless Network](#)
  - [I Cannot Complete the Wireless Network Setup Configuration](#)
  - [How to Enter Text on Your Brother Machine](#)
  - [Wireless LAN Report Error Codes](#)
-

## Use Wi-Fi Direct®

- [Print from Your Mobile Device Using Wi-Fi Direct](#)
- [Configure Your Wi-Fi Direct Network](#)
- [I Cannot Complete the Wireless Network Setup Configuration](#)

## Print from Your Mobile Device Using Wi-Fi Direct

**Related Models:** HL-L2350DW/HL-L2357DW/HL-L2375DW

Wi-Fi Direct is one of the wireless configuration methods developed by the Wi-Fi Alliance®. It allows you to configure a secured wireless network between your Brother machine and a mobile device, such as an Android™ device, Windows® device, iPhone, iPod touch, or iPad, without using an access point. Wi-Fi Direct supports wireless network configuration using the one-push or PIN Method of Wi-Fi Protected Setup™ (WPS). You can also configure a wireless network by manually setting an SSID and password. Your Brother machine's Wi-Fi Direct feature supports WPA2™ security with AES encryption.

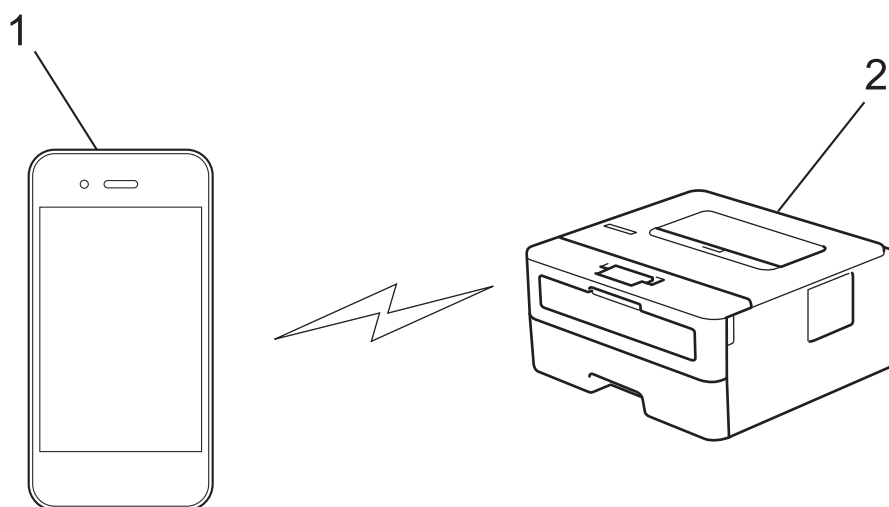

1. Mobile device
2. Your Brother machine



- Although the Brother machine can be used in both a wired and wireless network, only one connection method can be used at a time. However, a wireless network connection and Wi-Fi Direct connection, or a wired network connection (supported models only) and Wi-Fi Direct connection can be used at the same time.
- The Wi-Fi Direct-supported device can become a Group Owner (G/O). When configuring the Wi-Fi Direct network, the G/O serves as an access point.



### Related Information

- [Use Wi-Fi Direct®](#)

## Configure Your Wi-Fi Direct Network

Configure your Wi-Fi Direct network settings from your machine's control panel.

- [Wi-Fi Direct Network Configuration Overview](#)
- [Configure Your Wi-Fi Direct Network Using the One-Push Method](#)
- [Configure Your Wi-Fi Direct Network Using the One-Push Method of Wi-Fi Protected Setup™ \(WPS\)](#)
- [Configure Your Wi-Fi Direct Network Using the PIN Method](#)
- [Configure Your Wi-Fi Direct Network Using the PIN Method of Wi-Fi Protected Setup™ \(WPS\)](#)
- [Configure Your Wi-Fi Direct Network Manually](#)



## Wi-Fi Direct Network Configuration Overview

**Related Models:** HL-L2350DW/HL-L2357DW/HL-L2375DW

The following instructions offer five methods for configuring your Brother machine in a wireless network environment. Select the method you prefer for your environment:

Check your mobile device for configuration.

1. Does your mobile device support Wi-Fi Direct?

Option	Description
Yes	Go to Step 2
No	Go to Step 3

2. Does your mobile device support one-push configuration for Wi-Fi Direct?

Option	Description
Yes	See <i>Related Information</i> : Configure Your Wi-Fi Direct Network Using the One-Push Method.
No	See <i>Related Information</i> : Configure Your Wi-Fi Direct Network Using the PIN Method.

3. Does your mobile device support Wi-Fi Protected Setup™ (WPS)?

Option	Description
Yes	Go to Step 4
No	See <i>Related Information</i> : Configure Your Wi-Fi Direct Network Manually.

4. Does your mobile device support one-push configuration for Wi-Fi Protected Setup™ (WPS)?

Option	Description
Yes	See <i>Related Information</i> : Configure Your Wi-Fi Direct Network Using the One-Push Method of Wi-Fi Protected Setup™ (WPS).
No	See <i>Related Information</i> : Configure Your Wi-Fi Direct Network Using the PIN Method of Wi-Fi Protected Setup™ (WPS).

To use Brother iPrint&Scan functionality in a Wi-Fi Direct network configured by one-push configuration using Wi-Fi Direct or by PIN Method configuration using Wi-Fi Direct, the device you use to configure Wi-Fi Direct must be running Android™ 4.0 or greater.



### Related Information

- [Configure Your Wi-Fi Direct Network](#)
- [Configure Your Wi-Fi Direct Network Using the One-Push Method](#)
- [Configure Your Wi-Fi Direct Network Using the One-Push Method of Wi-Fi Protected Setup™ \(WPS\)](#)
- [Configure Your Wi-Fi Direct Network Using the PIN Method](#)
- [Configure Your Wi-Fi Direct Network Using the PIN Method of Wi-Fi Protected Setup™ \(WPS\)](#)

- 
- [Configure Your Wi-Fi Direct Network Manually](#)
-

## Configure Your Wi-Fi Direct Network Using the One-Push Method

**Related Models:** HL-L2350DW/HL-L2357DW/HL-L2375DW

If your mobile device supports Wi-Fi Direct, follow these steps to configure a Wi-Fi Direct network:

1. Press ▲ or ▼ to select the [Network] option, and then press **OK**.
2. Press ▲ or ▼ to select the [Wi-Fi Direct] option, and then press **OK**.
3. Press ▲ or ▼ to select the [Push Button] option, and then press **OK**.
4. When [Wi-Fi Direct On?] appears, press ▼ to accept. To cancel, press ▲.
5. Activate Wi-Fi Direct on your mobile device (see your mobile device's user's guide for instructions) when [Activate Wi-Fi Direct on other device and press OK.] appears on the machine's LCD. Press **OK** on your machine.  
This will start the Wi-Fi Direct setup. To cancel, press **Back**.
6. Do one of the following:
  - When your Brother machine is the Group Owner (G/O), connect your mobile device to the machine directly.
  - When your Brother machine is not the G/O, it will display available device names with which to configure a Wi-Fi Direct network. Press ▲ or ▼ to select the mobile device you want to connect to and press **OK**. To search for available devices again, press [<Rescan>], and then press **OK**.
7. If your mobile device connects successfully, the machine's LCD displays [Connected]. You have completed the Wi-Fi Direct network setup. The Mobile Print/Scan Guide for Brother iPrint&Scan contains information on printing from your mobile device. Go to your model's **Manuals** page on the Brother Solutions Center at [support.brother.com](http://support.brother.com) to see the guide.



### Related Information

- [Configure Your Wi-Fi Direct Network](#)
- [Wi-Fi Direct Network Configuration Overview](#)

## Configure Your Wi-Fi Direct Network Using the One-Push Method of Wi-Fi Protected Setup™ (WPS)

**Related Models:** HL-L2350DW/HL-L2357DW/HL-L2375DW

If your mobile device supports WPS (PBC: Push Button Configuration), follow these steps to configure a Wi-Fi Direct network:

1. Press ▲ or ▼ to select the [Network] option, and then press **OK**.
2. Press ▲ or ▼ to select the [Wi-Fi Direct] option, and then press **OK**.
3. Press ▲ or ▼ to select the [Group Owner] option, and then press **OK**.
4. Press ▲ or ▼ to select the [On] option, and then press **OK**.
5. Press ▲ or ▼ to select the [Push Button] option, and then press **OK**.
6. When [Wi-Fi Direct On?] appears, press ▼ to accept. To cancel, press ▲.
7. Activate your mobile device's WPS one-push configuration method (see your mobile device's user's guide for instructions) when [Activate Wi-Fi Direct on other device and press OK.] appears on the machine's LCD. Press **OK** on your machine.

This will start the Wi-Fi Direct setup. To cancel, press **Back**.

8. If your mobile device connects successfully, the machine's LCD displays [Connected]. You have completed the Wi-Fi Direct network setup. The Mobile Print/Scan Guide for Brother iPrint&Scan contains information on printing from your mobile device. Go to your model's **Manuals** page on the Brother Solutions Center at [support.brother.com](http://support.brother.com) to see the guide.



### Related Information

- [Configure Your Wi-Fi Direct Network](#)
- [Wi-Fi Direct Network Configuration Overview](#)

## Configure Your Wi-Fi Direct Network Using the PIN Method

**Related Models:** HL-L2350DW/HL-L2357DW/HL-L2375DW

If your mobile device supports the PIN Method of Wi-Fi Direct, follow these steps to configure a Wi-Fi Direct network:

1. Press ▲ or ▼ to select the [Network] option, and then press **OK**.
2. Press ▲ or ▼ to select the [Wi-Fi Direct] option, and then press **OK**.
3. Press ▲ or ▼ to select the [PIN Code] option, and then press **OK**.
4. When [Wi-Fi Direct On?] appears, press ▼ to accept. To cancel, press ▲.
5. Activate Wi-Fi Direct on your mobile device (see your mobile device's user's guide for instructions) when [Activate Wi-Fi Direct on other device and press OK.] appears on the machine's LCD. Press **OK** on your machine.  
This will start the Wi-Fi Direct setup. To cancel, press **Back**.
6. Do one of the following:
  - When your Brother machine is the Group Owner (G/O), it will wait for a connection request from your mobile device. When [Input PIN Code] appears, enter the PIN displayed on your mobile device in your Brother machine. Press **OK** to complete the setup.  
If the PIN is displayed on your Brother machine, enter the PIN in your mobile device.
  - When your Brother machine is not the G/O, it will display available device names with which to configure a Wi-Fi Direct network. Press ▲ or ▼ to select the mobile device you want to connect to and press **OK**. To search for available devices again, press [<Rescan>], and then press **OK**.
7. Do one of the following:
  - Press ▼ to display the PIN on your Brother machine, enter the PIN in your mobile device, and then go to the next step.
  - Press ▲ to enter the PIN displayed by your mobile device in your Brother machine. Press **OK**, and then go to the next step.  
If your mobile device does not display a PIN, press **Back** on your Brother machine. Go back to the first step and try again.
8. If your mobile device connects successfully, the machine's LCD displays [Connected]. You have completed the Wi-Fi Direct network setup. The Mobile Print/Scan Guide for Brother iPrint&Scan contains information on printing from your mobile device. Go to your model's **Manuals** page on the Brother Solutions Center at [support.brother.com](http://support.brother.com) to see the guide.



### Related Information

- [Configure Your Wi-Fi Direct Network](#)
- [Wi-Fi Direct Network Configuration Overview](#)

## Configure Your Wi-Fi Direct Network Using the PIN Method of Wi-Fi Protected Setup™ (WPS)

**Related Models:** HL-L2350DW/HL-L2357DW/HL-L2375DW

If your mobile device supports the PIN Method of Wi-Fi Protected Setup™ (WPS), follow these steps to configure a Wi-Fi Direct network:

1. Press ▲ or ▼ to select the [Network] option, and then press **OK**.
2. Press ▲ or ▼ to select the [Wi-Fi Direct] option, and then press **OK**.
3. Press ▲ or ▼ to select the [Group Owner] option, and then press **OK**.
4. Press ▲ or ▼ to select the [On] option, and then press **OK**.
5. Press ▲ or ▼ to select the [PIN Code] option, and then press **OK**.
6. When [Wi-Fi Direct On?] appears, press ▼ to accept. To cancel, press ▲.
7. Activate your mobile device's WPS PIN configuration method (see your mobile device's user's guide for instructions) when [Activate Wi-Fi Direct on other device and press OK.] appears on the machine's LCD. Press **OK** on your machine.  
This will start the Wi-Fi Direct setup. To cancel, press **Back**.
8. The machine will wait for a connection request from your mobile device. When [Input PIN Code] appears, enter the PIN displayed on your mobile device in the machine.
9. Press **OK**.
10. If your mobile device connects successfully, the machine's LCD displays [Connected]. You have completed the Wi-Fi Direct network setup. The Mobile Print/Scan Guide for Brother iPrint&Scan contains information on printing from your mobile device. Go to your model's **Manuals** page on the Brother Solutions Center at [support.brother.com](http://support.brother.com) to see the guide.



### Related Information

- [Configure Your Wi-Fi Direct Network](#)
- [Wi-Fi Direct Network Configuration Overview](#)

## Configure Your Wi-Fi Direct Network Manually

**Related Models:** HL-L2350DW/HL-L2357DW/HL-L2375DW

If your mobile device does not support Wi-Fi Direct or WPS, you must configure a Wi-Fi Direct network manually.

1. Press ▲ or ▼ to select the [Network] option, and then press **OK**.
2. Press ▲ or ▼ to select the [Wi-Fi Direct] option, and then press **OK**.
3. Press ▲ or ▼ to select the [Manual] option, and then press **OK**.
4. When [Wi-Fi Direct On?] appears, press ▼ to accept. To cancel, press ▲.
5. The machine will display the SSID name and Password for five minutes. Go to your mobile device's wireless network settings screen, select the SSID name, and then enter the password.
6. If your mobile device connects successfully, the machine's LCD displays [Connected]. You have completed the Wi-Fi Direct network setup. For information on printing from your mobile device, go to your model's **Manuals** page on the Brother Solutions Center at [support.brother.com](http://support.brother.com) to see the Mobile Print/Scan Guide for Brother iPrint&Scan.



### Related Information

- [Configure Your Wi-Fi Direct Network](#)
- [Wi-Fi Direct Network Configuration Overview](#)

## Advanced Network Features

- [Print the Network Configuration Report](#)
- [Print the WLAN Report](#)



## Print the Network Configuration Report

**Related Models:** HL-L2350DW/HL-L2357DW/HL-L2370DN/HL-L2375DW

The Network Configuration Report lists the network configuration, including the network print server settings.



- **Node Name:** The Node Name appears on the current Network Configuration Report. The default Node Name is "BRNxxxxxxxxxxxx" for a wired network or "BRWxxxxxxxxxxxx" for a wireless network (where "xxxxxxxxxxxx" is your machine's MAC Address / Ethernet Address.)
- If the [IP Address] on the Network Configuration Report shows 0.0.0.0, wait for one minute and try printing it again.
- You can find your machine's settings, such as the IP address, subnet mask, node name, and MAC Address on the report, for example:
  - IP address: 192.168.0.5
  - Subnet mask: 255.255.255.0
  - Node name: BRN000ca0000499
  - MAC Address: 00-0c-a0-00-04-99

1. Press **▲** or **▼** to select the [Print Reports] option, and then press **OK**.
2. Press **▲** or **▼** to select [Network Config].
3. Press **OK**.
4. Press **Go**.



### Related Information

- [Advanced Network Features](#)
- [Where Can I Find My Brother Machine's Network Settings?](#)
- [Use the Network Connection Repair Tool \(Windows®\)](#)
- [I Want to Check that My Network Devices are Working Correctly](#)
- [Access Web Based Management](#)

## Print the WLAN Report

**Related Models:** HL-L2350DW/HL-L2357DW/HL-L2375DW

The WLAN Report reflects your machine's wireless status. If the wireless connection fails, check the error code on the printed report.

1. Press ▲ or ▼ to select the [Print Reports] option, and then press **OK**.
2. Press ▲ or ▼ to select the [WLAN Report] option, and then press **OK**.
3. Press **Go**.

The machine will print the WLAN Report.



### Related Information

- [Advanced Network Features](#)
- [Wireless LAN Report Error Codes](#)
- [My Brother Machine Cannot Print over the Network](#)
- [I Want to Check that My Network Devices are Working Correctly](#)

## Wireless LAN Report Error Codes

**Related Models:** HL-L2350DW/HL-L2357DW/HL-L2375DW

If the Wireless LAN Report shows that the connection failed, check the error code on the printed report and see the corresponding instructions in the table:

Error Code	Problem and Recommended Solutions
TS-01	The wireless setting is not activated, change the wireless setting to ON. If a network cable is connected to your machine, disconnect it and change the wireless setting of your machine to ON.
TS-02	The wireless access point/router cannot be detected. 1. Check the following two points: <ul style="list-style-type: none"> <li>Unplug the power to your wireless access point/router, wait for 10 seconds, and then plug it back in.</li> <li>If your WLAN access point/router is using MAC address filtering, confirm that the MAC address of the Brother machine is allowed in the filter.</li> </ul> 2. If you manually entered the SSID and security information (SSID/authentication method/encryption method/Network Key), the information may be incorrect. Reconfirm the SSID and security information and re-enter the correct information as necessary. This device does not support a 5 GHz SSID/ESSID and you must select a 2.4 GHz SSID/ESSID. Make sure the access point/router is set to 2.4 GHz or 2.4 GHz/5 GHz mixed mode.
TS-04	The Authentication/Encryption methods used by the selected wireless access point/router are not supported by your machine. Change the authentication and encryption method of the wireless access point/router. Your machine supports the following authentication methods: <ul style="list-style-type: none"> <li>WPA-Personal TKIP or AES</li> <li>WPA2-Personal TKIP or AES</li> <li>Open WEP or None (without encryption)</li> <li>Shared key WEP</li> </ul> If your problem is not solved, the SSID or network settings you entered may be incorrect. Confirm the wireless network settings.
TS-05	The security information (SSID/Network Key) is incorrect. Confirm the wireless security information (Authentication method/Encryption method/Network Key).
TS-06	The machine cannot detect a WLAN access point/router that has WPS enabled. Confirm the wireless security information (Authentication method/Encryption method/Network Key).
TS-07	The machine cannot detect a WLAN access point/router that has WPS enabled. If you want to connect with WPS, you must operate both your machine and the WLAN access point/router. Confirm the connection method for WPS on WLAN access point/router and try starting again. If you do not know how to operate your WLAN access point/router using WPS, see the documentation provided with your WLAN access point/router, ask the manufacturer of your WLAN access point/router or ask your network administrator.

---

Error Code	Problem and Recommended Solutions
TS-08	Two or more WLAN access points that have WPS enabled are detected. <ul style="list-style-type: none"><li>• Confirm that only one WLAN access point/router within range has the WPS method active and try again.</li><li>• Try starting again after few minutes in order to avoid effects from other access points.</li></ul>



### Related Information

---

- [Print the WLAN Report](#)
  - [My Brother Machine Cannot Print over the Network](#)
  - [I Want to Check that My Network Devices are Working Correctly](#)
  - [Configure Your Machine for a Wireless Network Using the One Push Method of Wi-Fi Protected Setup™ \(WPS\)](#)
  - [Configure Your Machine for a Wireless Network Using the PIN Method of Wi-Fi Protected Setup™ \(WPS\)](#)
  - [Configure Your Machine for a Wireless Network Using the Machine's Control Panel Setup Wizard](#)
  - [Configure Your Machine for a Wireless Network When the SSID Is Not Broadcast](#)
-

## Technical Information for Advanced Users

- [Reset the Network Settings to the Factory Settings](#)

## Reset the Network Settings to the Factory Settings

**Related Models:** HL-L2350DW/HL-L2357DW/HL-L2370DN/HL-L2375DW

You can use your machine's control panel to reset the print server to its default factory settings. This resets all information, such as the password and IP address.



- This feature restores all wired (supported models only) and wireless network settings to the factory settings.
- You can also reset the print server to its factory settings using BRAdmin Light, BRAdmin Professional, or Web Based Management.

1. Press ▲ or ▼ to select the [Network] option, and then press **OK**.
2. Press ▲ or ▼ to select the [Network Reset] option, and then press **OK**.
3. Press ▼ for [Yes].

The machine will restart.



### Related Information

- [Technical Information for Advanced Users](#)

## Security

- [Lock the Machine Settings](#)
- [Network Security Features](#)

## Lock the Machine Settings

Before turning on the machine's Access Lock, make a careful note of your password. If you forget the password, you must reset all passwords stored in the machine by contacting your administrator or Brother customer service.

- [Setting Lock Overview](#)



## Setting Lock Overview

Use the Setting Lock feature to block unauthorised access to machine settings.

When Setting Lock is set to On, you cannot access the machine settings without entering the password.

- [Set the Setting Lock Password](#)
- [Change the Setting Lock Password](#)
- [Turn Setting Lock On](#)

## Set the Setting Lock Password

**Related Models:** HL-L2350DW/HL-L2357DW/HL-L2370DN/HL-L2375DW

1. Press ▲ or ▼ to display the [General Setup] option, and then press **OK**.
2. Press ▲ or ▼ to display the [Setting Lock] option, and then press **OK**.
3. Enter a four-digit number for the password.  
To enter each digit, press ▲ or ▼ to select a number, and then press **OK**.
4. When the LCD displays [Verify:], re-enter the new password.



### Related Information

- [Setting Lock Overview](#)

## Change the Setting Lock Password

**Related Models:** HL-L2350DW/HL-L2357DW/HL-L2370DN/HL-L2375DW

1. Press ▲ or ▼ to display the [General Setup] option, and then press **OK**.
2. Press ▲ or ▼ to display the [Setting Lock] option, and then press **OK**.
3. Press ▲ or ▼ to select the [Set Password] option, and then press **OK**.
4. Enter the current four-digit password.  
To enter each digit, press ▲ or ▼ to select a number, and then press **OK**.
5. Enter a new four-digit password.  
To enter each digit, press ▲ or ▼ to select a number, and then press **OK**.
6. When the LCD displays [Verify:], re-enter the new password.



### Related Information

- [Setting Lock Overview](#)

## Turn Setting Lock On

**Related Models:** HL-L2350DW/HL-L2357DW/HL-L2370DN/HL-L2375DW

1. Press ▲ or ▼ to display the [General Setup] option, and then press **OK**.
2. Press ▲ or ▼ to display the [Setting Lock] option, and then press **OK**.
3. Press **OK** when the LCD displays [On].
4. Enter the current four-digit password.

To enter each digit, press ▲ or ▼ to select a number, and then press **OK**.



To turn Setting Lock off, press **OK**. Press ▼ to select [Yes] when the LCD displays [Unlock?], enter the current four-digit password.



### Related Information

- [Setting Lock Overview](#)

## Network Security Features

- [Before Using Network Security Features](#)
- [Manage Your Network Machine Securely Using SSL/TLS](#)
- [Send an Email Securely](#)

## Before Using Network Security Features

**Related Models:** HL-L2350DW/HL-L2357DW/HL-L2370DN/HL-L2375DW

Your Brother machine employs some of the latest network security and encryption protocols available today. These network features can be integrated into your overall network security plan to help protect your data and prevent unauthorised access to the machine.



We recommend disabling the FTP server and TFTP protocols. Accessing the machine using these protocols is not secure.



### Related Information

- [Network Security Features](#)

## Manage Your Network Machine Securely Using SSL/TLS

- [Introduction to SSL/TLS](#)
- [Certificates and Web Based Management](#)
- [Manage Your Network Machine Securely Using Web Based Management](#)
- [Manage Your Network Machine Securely Using BRAdmin Professional \(Windows®\)](#)
- [Print Documents Securely Using SSL/TLS](#)

## Introduction to SSL/TLS

**Related Models:** HL-L2350DW/HL-L2357DW/HL-L2370DN/HL-L2375DW

Secure Socket Layer (SSL) or Transport Layer Security (TLS) is an effective method of protecting data sent over a local or wide area network (LAN or WAN). It works by encrypting data, such as a print job, sent over a network, so anyone trying to capture it will not be able to read it.

SSL/TLS can be configured on both wired and wireless networks and will work with other forms of security such as WPA keys and firewalls.



### Related Information

- [Manage Your Network Machine Securely Using SSL/TLS](#)
- [Brief History of SSL/TLS](#)
- [Benefits of Using SSL/TLS](#)



## Brief History of SSL/TLS

**Related Models:** HL-L2350DW/HL-L2357DW/HL-L2370DN/HL-L2375DW

SSL/TLS was originally created to secure web traffic information, particularly data sent between web browsers and servers. For example, when you use Internet Explorer® for Internet Banking and you see https:// and the little padlock icon in the web browser, you are using SSL. SSL grew to work with additional applications, such as Telnet, printer, and FTP software, in order to become a universal solution for online security. Its original design intentions are still being used today by many online retailers and banks to secure sensitive data, such as credit card numbers, customer records, etc.

SSL/TLS uses extremely high levels of encryption and is trusted by banks all over the world.



### Related Information

- [Introduction to SSL/TLS](#)

## Benefits of Using SSL/TLS

**Related Models:** HL-L2350DW/HL-L2357DW/HL-L2370DN/HL-L2375DW

The primary benefit of using SSL/TLS on Brother machines is to guarantee secure printing over an IP network by restricting unauthorised users from reading data sent to the machine. SSL's key selling point is that it can be used to print confidential data securely. For example, an HR department in a large company may be printing wage slips on a regular basis. Without encryption, the data contained on these wages slips can be read by other network users. However, with SSL/TLS, anyone trying to capture the data will see a confusing page of code and not the actual wage slip.



### Related Information

- [Introduction to SSL/TLS](#)

## Certificates and Web Based Management

You must configure a certificate to manage your networked Brother machine securely using SSL/TLS. You must use Web Based Management to configure a certificate.

- [Supported Security Certificate Features](#)
- [Create and Install a Certificate](#)
- [Manage Multiple Certificates](#)

## Supported Security Certificate Features

**Related Models:** HL-L2350DW/HL-L2357DW/HL-L2370DN/HL-L2375DW

Your Brother machine supports the use of multiple security certificates, which allows secure management, authentication, and communication with the machine. The following security certificate features can be used with the machine:

- SSL/TLS communication
- SSL communication for SMTP

The Brother machine supports the following:

- Pre-installed certificate

Your machine has a pre-installed self-signed certificate. This certificate enables you to use SSL/TLS communication without creating or installing a different certificate.



The pre-installed self-signed certificate cannot protect your communication from being compromised. We recommend using a certificate that is issued by a trusted organisation for better security.

- Self-signed certificate

This print server issues its own certificate. Using this certificate, you can easily use the SSL/TLS communication without creating or installing a different certificate from a CA.

- Certificate from a Certificate Authority (CA)

There are two methods for installing a certificate from a CA. If you already have a certificate from a CA or if you want to use a certificate from an external trusted CA:

- When using a Certificate Signing Request (CSR) from this print server.
- When importing a certificate and a private key.

- Certificate Authority (CA) Certificate

To use a CA certificate that identifies the CA and owns its private key, you must import that CA certificate from the CA before configuring the security features of the Network.



- If you are going to use SSL/TLS communication, we recommend contacting your system administrator first.
- When you reset the print server back to its default factory settings, the certificate and the private key that are installed will be deleted. If you want to keep the same certificate and the private key after resetting the print server, export them before resetting, and then reinstall them.



### Related Information

- [Certificates and Web Based Management](#)

## **Create and Install a Certificate**

- [Step by Step Guide for Creating and Installing a Certificate](#)
- [Create and Install a Self-signed Certificate](#)
- [Create and Install a Certificate from a Certificate Authority \(CA\)](#)
- [Import and Export a CA Certificate](#)

## Step by Step Guide for Creating and Installing a Certificate

**Related Models:** HL-L2350DW/HL-L2357DW/HL-L2370DN/HL-L2375DW

There are two options when choosing a security certificate: use a self-signed certificate or use a certificate from a Certificate Authority (CA).

These are a brief summary of the actions required, based on the option you choose.

### Option 1

#### Self-Signed Certificate

1. Create a self-signed certificate using Web Based Management.
2. Install the self-signed certificate on your computer.

### Option 2

#### Certificate from a CA

1. Create a Certificate Signing Request (CSR) using Web Based Management.
2. Install the certificate issued by the CA on your Brother machine using Web Based Management.
3. Install the certificate on your computer.



#### Related Information

- [Create and Install a Certificate](#)

## **Create and Install a Self-signed Certificate**

- [Create a Self-signed Certificate](#)
- [Install the Self-signed Certificate for Windows® users with Administrator Rights](#)
- [Import and Export the Self-signed Certificate on your Brother Machine](#)

## Create a Self-signed Certificate

**Related Models:** HL-L2350DW/HL-L2357DW/HL-L2370DN/HL-L2375DW

1. Start your web browser.
2. Type "http://machine's IP address" in your browser's address bar (where "machine's IP address" is the machine's IP address).

For example:

http://192.168.1.2



- If you are using a Domain Name System or enable a NetBIOS name, you can type another name, such as "SharedPrinter" instead of the IP address.

- For example:

http://SharedPrinter

If you enable a NetBIOS name, you can also use the node name.

- For example:

http://brnxxxxxxxxxxxx

The NetBIOS name can be found in the Network Configuration Report.

- For Mac, access Web Based Management by clicking the machine's icon on the **Status Monitor** screen.

3. No password is required by default. Type a password if you have set one, and then click .
4. Click the **Network** tab.
5. Click the **Security** tab.
6. Click **Certificate**.
7. Click **Create Self-Signed Certificate**.
8. Enter a **Common Name** and a **Valid Date**.
  - The length of the **Common Name** is less than 64 bytes. Enter an identifier, such as an IP address, node name, or domain name to use when accessing this machine through SSL/TLS communication. The node name is displayed by default.
  - A warning will appear if you use the IPPS or HTTPS protocol and enter a different name in the URL than the **Common Name** that was used for the self-signed certificate.
9. Select your setting from the **Public Key Algorithm** drop-down list. The default setting is **RSA(2048bit)**.
10. Select your setting from the **Digest Algorithm** drop-down list. The default setting is **SHA256**.
11. Click **Submit**.
12. Click **Network**.
13. Click **Protocol**.
14. Click **HTTP Server Settings**.
15. Select the certificate you want to configure from the **Select the Certificate** drop-down list.
16. Click **Submit**.

The following screen appears.



## HTTP Server Settings

---

The setting for high security in communication was done.

---

To activate your new settings, this Device needs to restart.

Note: Any jobs in progress will be aborted.

To activate other protocols that have secure settings after restarting, check the box below.

Activate other protocols that have secure settings.

Would you like to restart immediately?

---

Yes

No

17. Click **Yes** to restart your print server.

The self-signed certificate is created and saved in your machine's memory.

To use SSL/TLS communication, the self-signed certificate must be installed on your computer.







### Related Information

- [Create and Install a Self-signed Certificate](#)

## Install the Self-signed Certificate for Windows® users with Administrator Rights

**Related Models:** HL-L2350DW/HL-L2357DW/HL-L2370DN/HL-L2375DW

The following steps are for Microsoft® Internet Explorer®. If you use another web browser, consult the documentation for your web browser to get help with installing certificates.

1. Do one of the following:
  - (Windows® 7 and Windows Server® 2008)  
Click  (**Start**) > **All Programs**.
  - (Windows® 8 )  
Right-click the  (**Internet Explorer**) icon on the taskbar.
  - (Windows® 10 and Windows Server® 2016)  
Click  > **Windows Accessories**.
  - (Windows Server® 2012 and Windows Server® 2012 R2)  
Click  (**Internet Explorer**), and then right-click the  (**Internet Explorer**) icon that appears on the taskbar.
2. Right-click **Internet Explorer**, and then click **Run as administrator**.



If the **More** option appears, click **More**.

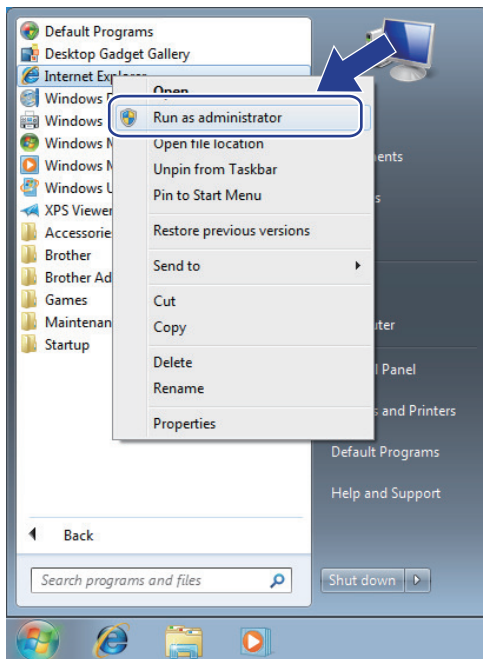

If the **User Account Control** screen appears, click **Yes**.

3. Type "https://machine's IP address" in your browser's address bar to access your machine (where "machine's IP address" is the machine's IP address or the node name that you assigned for the certificate).

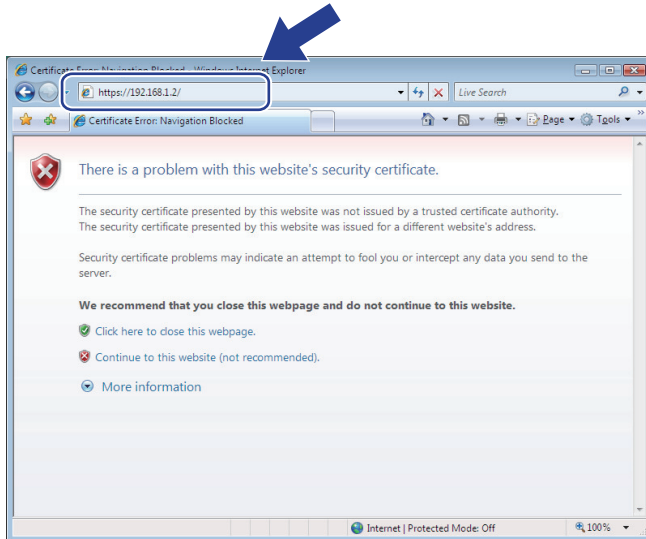

4. Click **Continue to this website (not recommended)**.

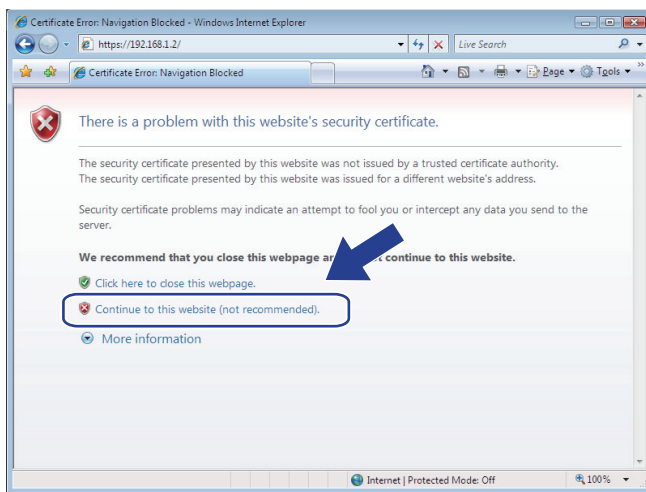

5. Click **Certificate error**, and then click **View certificates**.

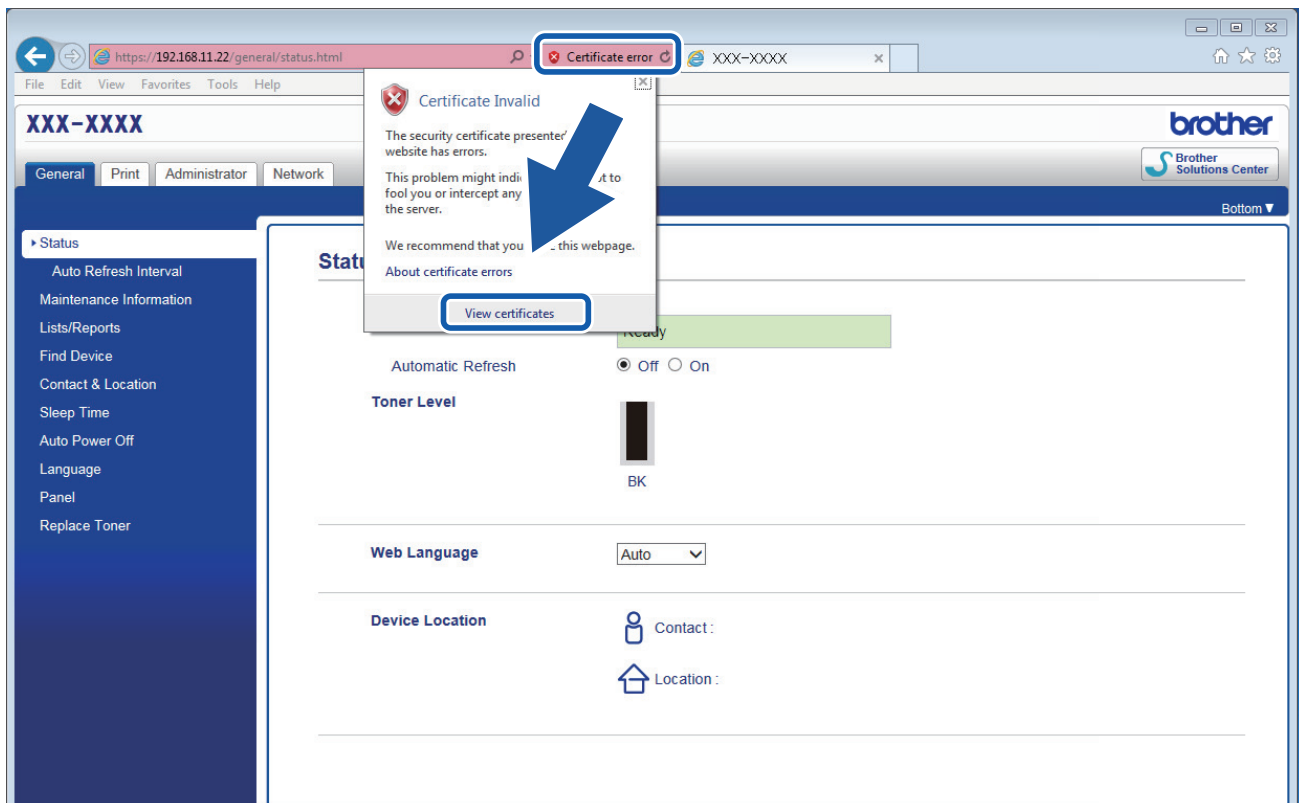

6. Click **Install Certificate...**

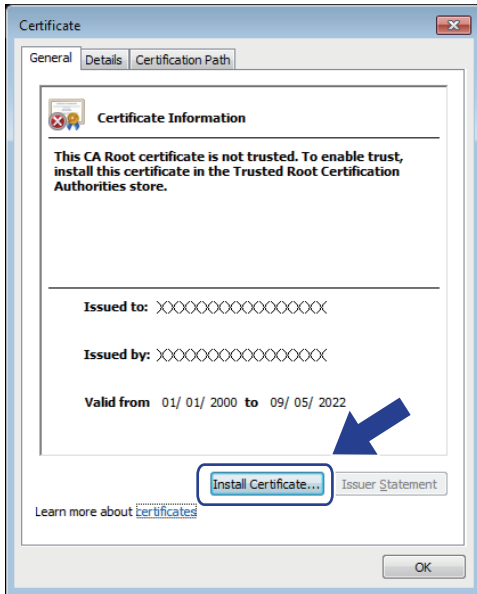

7. When the **Certificate Import Wizard** appears, click **Next**.
8. Select **Place all certificates in the following store**, and then click **Browse....**

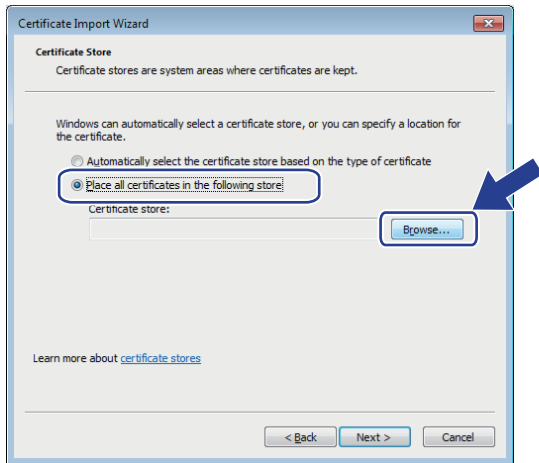

9. Select **Trusted Root Certification Authorities**, and then click **OK**.



10. Click **Next**.

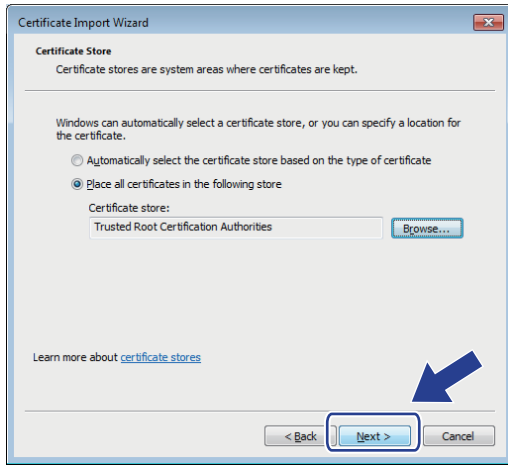

11. Click **Finish**.

12. Click **Yes**, if the fingerprint (thumbprint) is correct.

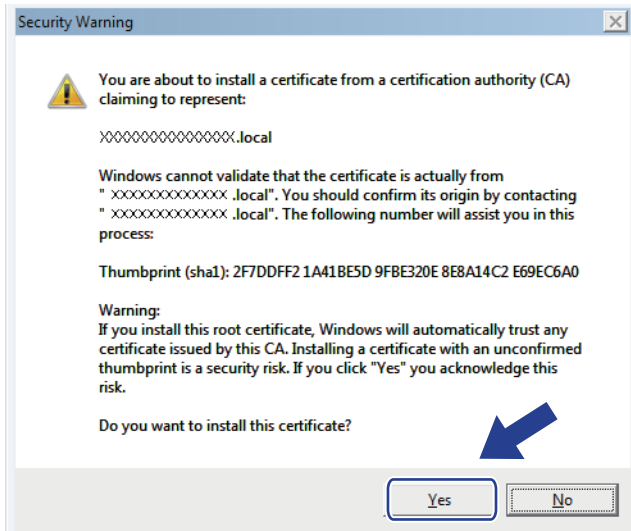

The fingerprint (thumbprint) is printed on the Network Configuration Report.

13. Click **OK**.

The self-signed certificate is now installed on your computer, and SSL/TLS communication is available.



## Related Information

- [Create and Install a Self-signed Certificate](#)

## **Import and Export the Self-signed Certificate on your Brother Machine**

You can store the self-signed certificates on your Brother machine and manage them by importing and exporting.

- [Import the Self-signed Certificate](#)
- [Export the Self-signed Certificate](#)

## Import the Self-signed Certificate

**Related Models:** HL-L2350DW/HL-L2357DW/HL-L2370DN/HL-L2375DW

1. Start your web browser.
2. Type "http://machine's IP address" in your browser's address bar (where "machine's IP address" is the machine's IP address).

For example:

http://192.168.1.2



- If you are using a Domain Name System or enable a NetBIOS name, you can type another name, such as "SharedPrinter" instead of the IP address.

- For example:

http://SharedPrinter

If you enable a NetBIOS name, you can also use the node name.

- For example:

http://brnxxxxxxxxxxxx

The NetBIOS name can be found in the Network Configuration Report.

- For Mac, access Web Based Management by clicking the machine's icon on the **Status Monitor** screen.

3. No password is required by default. Type a password if you have set one, and then click .
4. Click the **Network** tab.
5. Click the **Security** tab.
6. Click **Certificate**.
7. Click **Import Certificate and Private Key**.
8. Browse to the file you want to import.
9. Type the password if the file is encrypted, and then click **Submit**.

The self-signed certificate is imported to your machine.

To use SSL/TLS communication, the self-signed certificate must also be installed on your computer. Contact your network administrator.



### Related Information

- [Import and Export the Self-signed Certificate on your Brother Machine](#)

## Export the Self-signed Certificate

**Related Models:** HL-L2350DW/HL-L2357DW/HL-L2370DN/HL-L2375DW

1. Start your web browser.
2. Type "http://machine's IP address" in your browser's address bar (where "machine's IP address" is the machine's IP address).

For example:

http://192.168.1.2



- If you are using a Domain Name System or enable a NetBIOS name, you can type another name, such as "SharedPrinter" instead of the IP address.

- For example:

http://SharedPrinter

If you enable a NetBIOS name, you can also use the node name.

- For example:

http://brnxxxxxxxxxxxx

The NetBIOS name can be found in the Network Configuration Report.

- For Mac, access Web Based Management by clicking the machine's icon on the **Status Monitor** screen.

3. No password is required by default. Type a password if you have set one, and then click .
4. Click the **Network** tab.
5. Click the **Security** tab.
6. Click **Certificate**.
7. Click **Export** shown with **Certificate List**.
8. If you want to encrypt the file, type a password in the **Enter password** field.  
If the **Enter password** field is blank, your output file will not be encrypted.
9. Type the password again in the **Retype password** field, and then click **Submit**.
10. Click **Save**.
11. Specify the location where you want to save the file.

The self-signed certificate is exported to your computer.

You can also import the self-signed certificate to your computer.



### Related Information

- [Import and Export the Self-signed Certificate on your Brother Machine](#)



## **Create and Install a Certificate from a Certificate Authority (CA)**

If you already have a certificate from an external trusted CA, you can store the certificate and private key on the machine and manage them by importing and exporting. If you do not have a certificate from an external trusted CA, create a Certificate Signing Request (CSR), send it to a CA for authentication, and install the returned certificate on your machine.

- [Create a Certificate Signing Request \(CSR\)](#)
- [Install a Certificate on Your Brother Machine](#)
- [Import and Export the Certificate and Private Key](#)

## Create a Certificate Signing Request (CSR)

**Related Models:** HL-L2350DW/HL-L2357DW/HL-L2370DN/HL-L2375DW

A Certificate Signing Request (CSR) is a request sent to a Certificate Authority (CA) to authenticate the credentials contained within the certificate.

We recommend installing a Root Certificate from the CA on your computer before creating the CSR.

1. Start your web browser.
2. Type "http://machine's IP address" in your browser's address bar (where "machine's IP address" is the machine's IP address).

For example:

http://192.168.1.2



- If you are using a Domain Name System or enable a NetBIOS name, you can type another name, such as "SharedPrinter" instead of the IP address.

- For example:

http://SharedPrinter

If you enable a NetBIOS name, you can also use the node name.

- For example:

http://brnxxxxxxxxxxxx

The NetBIOS name can be found in the Network Configuration Report.

- For Mac, access Web Based Management by clicking the machine's icon on the **Status Monitor** screen.

3. No password is required by default. Type a password if you have set one, and then click .
4. Click the **Network** tab.
5. Click the **Security** tab.
6. Click **Certificate**.
7. Click **Create CSR**.
8. Type a **Common Name** (required) and add other information about your **Organization** (optional).



- Your company details are required so that a CA can confirm your identity and verify it to the outside world.
- The length of the **Common Name** must be less than 64 bytes. Enter an identifier, such as an IP address, node name, or domain name to use when accessing this printer through SSL/TLS communication. The node name is displayed by default. The **Common Name** is required.
- A warning will appear if you type a different name in the URL than the Common Name that was used for the certificate.
- The length of the **Organization**, the **Organization Unit**, the **City/Locality** and the **State/Province** must be less than 64 bytes.
- The **Country/Region** should be a two character ISO 3166 country code.
- If you are configuring an X.509v3 certificate extension, select the **Configure extended partition** check box, and then select **Auto (Register IPv4)** or **Manual**.

9. Select your setting from the **Public Key Algorithm** drop-down list. The default setting is **RSA(2048bit)**.
10. Select your setting from the **Digest Algorithm** drop-down list. The default setting is **SHA256**.
11. Click **Submit**.

---

The CSR appears on your screen. Save the CSR as a file or copy and paste it into an online CSR form offered by a Certificate Authority.

12. Click **Save**.



- 
- Follow your CA's policy regarding the method to send a CSR to your CA.
  - If you are using the Enterprise root CA of Windows Server® 2008/2012/2012 R2/2016, we recommend using the Web Server for the certificate template to securely create the Client Certificate. For more information, go to your model's page on the Brother Solutions Center at [support.brother.com](http://support.brother.com).
- 



### Related Information

- [Create and Install a Certificate from a Certificate Authority \(CA\)](#)
-

## Install a Certificate on Your Brother Machine

**Related Models:** HL-L2350DW/HL-L2357DW/HL-L2370DN/HL-L2375DW

When you receive a certificate from a CA, follow the steps below to install it into the print server:

Only a certificate issued with your machine's CSR can be installed onto the machine. When you want to create another CSR, make sure that the certificate is installed before creating another CSR. Create another CSR only after installing the certificate on the machine. If you do not, the CSR you create before installing will be invalid.

1. Start your web browser.
2. Type "http://machine's IP address" in your browser's address bar (where "machine's IP address" is the machine's IP address).

For example:

http://192.168.1.2



- If you are using a Domain Name System or enable a NetBIOS name, you can type another name, such as "SharedPrinter" instead of the IP address.

- For example:

http://SharedPrinter

If you enable a NetBIOS name, you can also use the node name.

- For example:

http://brnxxxxxxxxxxxx

The NetBIOS name can be found in the Network Configuration Report.

- For Mac, access Web Based Management by clicking the machine's icon on the **Status Monitor** screen.

3. No password is required by default. Type a password if you have set one, and then click .
4. Click the **Network** tab.
5. Click the **Security** tab.
6. Click **Certificate**.
7. Click **Install Certificate**.
8. Browse to the file that contains the certificate issued by the CA, and then click **Submit**.

The certificate has been created successfully and saved in your machine's memory successfully.

To use SSL/TLS communication, the Root Certificate from the CA must be installed on your computer. Contact your network administrator.



### Related Information

- [Create and Install a Certificate from a Certificate Authority \(CA\)](#)

## **Import and Export the Certificate and Private Key**

Store the certificate and private key on your machine and manage them by importing and exporting them.

- [Import a Certificate and Private Key](#)
- [Export the Certificate and Private Key](#)

## Import a Certificate and Private Key

**Related Models:** HL-L2350DW/HL-L2357DW/HL-L2370DN/HL-L2375DW

1. Start your web browser.
2. Type "http://machine's IP address" in your browser's address bar (where "machine's IP address" is the machine's IP address).

For example:

http://192.168.1.2



- If you are using a Domain Name System or enable a NetBIOS name, you can type another name, such as "SharedPrinter" instead of the IP address.

- For example:

http://SharedPrinter

If you enable a NetBIOS name, you can also use the node name.

- For example:

http://brnxxxxxxxxxxxx

The NetBIOS name can be found in the Network Configuration Report.

- For Mac, access Web Based Management by clicking the machine's icon on the **Status Monitor** screen.

3. No password is required by default. Type a password if you have set one, and then click .
4. Click the **Network** tab.
5. Click the **Security** tab.
6. Click **Certificate**.
7. Click **Import Certificate and Private Key**.
8. Browse to the file you want to import.
9. Type the password if the file is encrypted, and then click **Submit**.

The certificate and private key are imported to your machine.

To use SSL/TLS communication, the Root Certificate from the CA must also be installed on your computer. Contact your network administrator.



### Related Information

- [Import and Export the Certificate and Private Key](#)

## Export the Certificate and Private Key

**Related Models:** HL-L2350DW/HL-L2357DW/HL-L2370DN/HL-L2375DW

1. Start your web browser.
2. Type "http://machine's IP address" in your browser's address bar (where "machine's IP address" is the machine's IP address).

For example:

http://192.168.1.2



- If you are using a Domain Name System or enable a NetBIOS name, you can type another name, such as "SharedPrinter" instead of the IP address.

- For example:

http://SharedPrinter

If you enable a NetBIOS name, you can also use the node name.

- For example:

http://brnxxxxxxxxxxxx

The NetBIOS name can be found in the Network Configuration Report.

- For Mac, access Web Based Management by clicking the machine's icon on the **Status Monitor** screen.

3. No password is required by default. Type a password if you have set one, and then click .
4. Click the **Network** tab.
5. Click the **Security** tab.
6. Click **Certificate**.
7. Click **Export** shown with **Certificate List**.
8. Enter the password if you want to encrypt the file.  
If a blank password is used, the output is not encrypted.
9. Enter the password again for confirmation, and then click **Submit**.
10. Click **Save**.
11. Specify the location where you want to save the file.

The certificate and private key are exported to your computer.

You can also import the certificate to your computer.



### Related Information

- [Import and Export the Certificate and Private Key](#)

## Import and Export a CA Certificate

You can import, export and store CA certificates on your Brother machine.

- [Import a CA Certificate](#)
- [Export a CA Certificate](#)



## Import a CA Certificate

**Related Models:** HL-L2350DW/HL-L2357DW/HL-L2370DN/HL-L2375DW

1. Start your web browser.
2. Type "http://machine's IP address" in your browser's address bar (where "machine's IP address" is the machine's IP address).

For example:

http://192.168.1.2



- If you are using a Domain Name System or enable a NetBIOS name, you can type another name, such as "SharedPrinter" instead of the IP address.

- For example:

http://SharedPrinter

If you enable a NetBIOS name, you can also use the node name.

- For example:

http://brnxxxxxxxxxxxx

The NetBIOS name can be found in the Network Configuration Report.

- For Mac, access Web Based Management by clicking the machine's icon on the **Status Monitor** screen.

3. No password is required by default. Type a password if you have set one, and then click .
4. Click the **Network** tab.
5. Click the **Security** tab.
6. Click **CA Certificate**.
7. Click **Import CA Certificate**.
8. Browse to the file you want to import.
9. Click **Submit**.



### Related Information

- [Import and Export a CA Certificate](#)

## Export a CA Certificate

**Related Models:** HL-L2350DW/HL-L2357DW/HL-L2370DN/HL-L2375DW

1. Start your web browser.
2. Type "http://machine's IP address" in your browser's address bar (where "machine's IP address" is the machine's IP address).

For example:

http://192.168.1.2



- If you are using a Domain Name System or enable a NetBIOS name, you can type another name, such as "SharedPrinter" instead of the IP address.

- For example:

http://SharedPrinter

If you enable a NetBIOS name, you can also use the node name.

- For example:

http://brnxxxxxxxxxxxx

The NetBIOS name can be found in the Network Configuration Report.

- For Mac, access Web Based Management by clicking the machine's icon on the **Status Monitor** screen.

3. No password is required by default. Type a password if you have set one, and then click .
4. Click the **Network** tab.
5. Click the **Security** tab.
6. Click **CA Certificate**.
7. Select the certificate you want to export and click **Export**.
8. Click **Submit**.
9. Click **Save**.
10. Specify where on your computer you want to save the exported certificate, and save it.



### Related Information

- [Import and Export a CA Certificate](#)

## Manage Multiple Certificates

**Related Models:** HL-L2350DW/HL-L2357DW/HL-L2370DN/HL-L2375DW

The multiple certificate feature allows you to use Web Based Management to manage each certificate installed on your machine. In Web Based Management, navigate to the **Certificate** or **CA Certificate** screen to view certificate content, delete, or export your certificates.

	Maximum Number of Certificates Stored UP on Brother Machine
Self-signed Certificate or Certificate Issued by a CA	3
CA Certificate	3

You can store up to 3 Certificate Authority (CA) certificates using SMTP over SSL (only available for certain models).

We recommend storing one less certificate than allowed, reserving an empty spot in case of certificate expiration. When a certificate expires, import a new certificate into the reserved spot, and then delete the expired certificate. This ensures that you avoid configuration failure.



- When you use SSL for SMTP communications, you do not have to choose the certificate. The necessary certificate will be chosen automatically.



### Related Information

- [Certificates and Web Based Management](#)

## Manage Your Network Machine Securely Using Web Based Management

**Related Models:** HL-L2350DW/HL-L2357DW/HL-L2370DN/HL-L2375DW

To manage your network machine securely, you must use management utilities with security protocols.

We recommend using the HTTPS protocol for secure management. To use this protocol, HTTPS must be enabled on your machine.



- The HTTPS protocol is enabled by default.
- You can change the HTTPS protocol settings using the Web Based Management screen.

1. Start your web browser.
2. Type "https://Common Name" in your browser's address bar (where "Common Name" is the Common Name that you assigned to the certificate; this could be your IP address, node name, or domain name).
3. No password is required by default. Type a password if you have set one, and then click .
4. You can now access the machine using HTTPS.



- If you use the SNMPv3 protocol, follow the steps below.
- You can also change the SNMP settings by using BRAdmin Professional.

5. Click the **Network** tab.
6. Click **Protocol**.
7. Make sure the **SNMP** setting is enabled, and then click **Advanced Settings**.
8. Configure the SNMP settings.

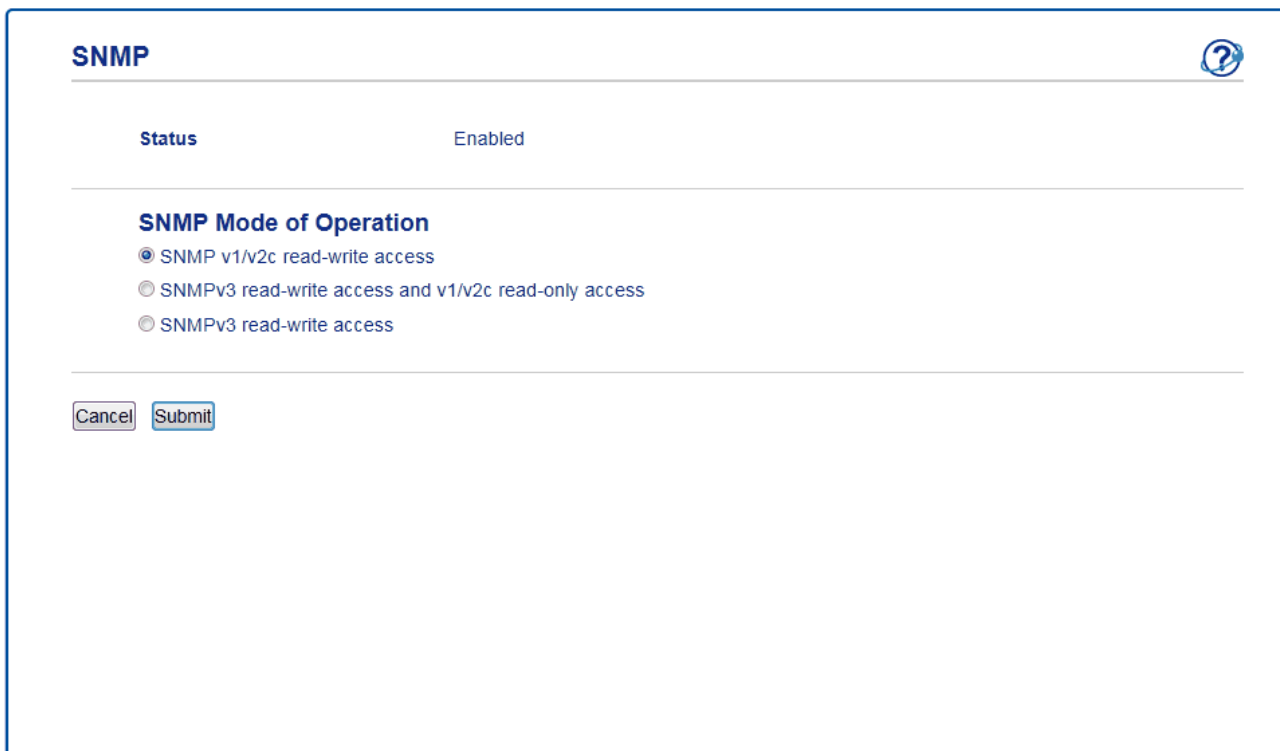

**SNMP** 

Status Enabled

**SNMP Mode of Operation**

SNMP v1/v2c read-write access

SNMPv3 read-write access and v1/v2c read-only access

SNMPv3 read-write access

There are three options for **SNMP Mode of Operation**.

- **SNMP v1/v2c read-write access**

---

In this mode, the print server uses version 1 and version 2c of the SNMP protocol. You can use all Brother applications in this mode. However, it is not secure since it will not authenticate the user, and data will not be encrypted.

- **SNMPv3 read-write access and v1/v2c read-only access**

In this mode, the print server uses the read-write access of version 3 and the read-only access of version 1 and version 2c of the SNMP protocol.



---

When you use **SNMPv3 read-write access and v1/v2c read-only access** mode, some Brother applications (such as BRAdmin Light) that access the print server do not work correctly since they authorize the read-only access of version 1 and version 2c. If you want to use all applications, we recommend using **SNMP v1/v2c read-write access** mode.

- **SNMPv3 read-write access**

In this mode, the print server uses version 3 of the SNMP protocol. If you want to manage the print server securely, use this mode.



---

When you use **SNMPv3 read-write access** mode, note the following:

- You can use only BRAdmin Professional or Web Based Management to manage the print server.
- Except for BRAdmin Professional, all applications that use SNMPv1/v2c will be restricted. To allow the use of SNMPv1/v2c applications, use **SNMPv3 read-write access and v1/v2c read-only access** or **SNMP v1/v2c read-write access** mode.

---

9. Click **Submit**.



## Related Information

- [Manage Your Network Machine Securely Using SSL/TLS](#)

## Manage Your Network Machine Securely Using BRAdmin Professional (Windows®)

**Related Models:** HL-L2350DW/HL-L2357DW/HL-L2370DN/HL-L2375DW

To use BRAdmin Professional utility, you must:

- Use the latest version of BRAdmin Professional. Go to your model's **Downloads** page on the Brother Solutions Center at [support.brother.com](http://support.brother.com).
- Use Web Based Management with the HTTPS protocol if you use BRAdmin Professional and Web Based Management together.
- Use a different password in each group if you are managing a mixed group of older and newer print servers with BRAdmin Professional. This will ensure security is maintained on the newer print servers.



- "Older versions of BRAdmin" refer to BRAdmin Professional older than Ver. 2.80 and BRAdmin Light for Mac older than Ver.1.10.
- "Older print servers" refer to NC-2000 series, NC-2100p, NC-3100h, NC-3100s, NC-4100h, NC-5100h, NC-5200h, NC-6100h, NC-6200h, NC-6300h, NC-6400h, NC-8000, NC-100h, NC-110h, NC-120w, NC-130h, NC-140w, NC-8100h, NC-9100h, NC-7100w, NC-7200w and NC-2200w.



### Related Information

- [Manage Your Network Machine Securely Using SSL/TLS](#)

## Print Documents Securely Using SSL/TLS

**Related Models:** HL-L2350DW/HL-L2357DW/HL-L2370DN/HL-L2375DW

To print documents securely with IPP protocol, use the IPPS protocol.

1. Start your web browser.
2. Type "http://machine's IP address" in your browser's address bar (where "machine's IP address" is the machine's IP address).

For example:

http://192.168.1.2



- If you are using a Domain Name System or enable a NetBIOS name, you can type another name, such as "SharedPrinter" instead of the IP address.

- For example:

http://SharedPrinter

If you enable a NetBIOS name, you can also use the node name.

- For example:

http://brnxxxxxxxxxxxx

The NetBIOS name can be found in the Network Configuration Report.

- For Mac, access Web Based Management by clicking the machine's icon on the **Status Monitor** screen.

3. No password is required by default. Type a password if you have set one, and then click .
4. Click the **Network** tab.
5. Click **Protocol**. Make sure the **IPP** check box is selected.



If the **IPP** check box is not selected, select the **IPP** check box, and then click **Submit**.

Restart your machine to activate the configuration.

After the machine restarts, return to the machine's web page, click the **Network** tab, and then click **Protocol**.

6. Click **HTTP Server Settings**.
7. Select the **HTTPS(Port 443)** check box in the **IPP**, and then click **Submit**.
8. Restart your machine to activate the configuration.

Communication using IPPS cannot prevent unauthorised access to the print server.



### Related Information

- [Manage Your Network Machine Securely Using SSL/TLS](#)

## Send an Email Securely

- [Configure Email Sending Using Web Based Management](#)
- [Send an Email with User Authentication](#)
- [Send an Email Securely Using SSL/TLS](#)



## Configure Email Sending Using Web Based Management

**Related Models:** HL-L2350DW/HL-L2357DW/HL-L2370DN/HL-L2375DW

We recommend using Web Based Management to configure secured email sending with user authentication, or email sending using SSL/TLS.

1. Start your web browser.
2. Type "http://machine's IP address" in your browser's address bar (where "machine's IP address" is the machine's IP address).  
For example:  
http://192.168.1.2
3. No password is required by default. Type a password if you have set one, and then click .
4. Click the **Network** tab.
5. Click the **Protocol** menu in the left navigation bar.
6. In the **SMTP** field, click **Advanced Settings** and make sure the status of **SMTP** is **Enabled**.
7. Configure the **SMTP** settings.
  - Confirm that the email settings are correct after configuration by sending a test email.
  - If you do not know the SMTP server settings, contact your network administrator or Internet Service Provider (ISP).
8. When finished, click **Submit**.  
The **Test Send E-mail Configuration** dialog box appears.
9. Follow the instructions in the dialog box to test the current settings.

### Related Information

- [Send an Email Securely](#)

## Send an Email with User Authentication

**Related Models:** HL-L2350DW/HL-L2357DW/HL-L2370DN/HL-L2375DW

Your Brother machine supports the SMTP-AUTH method to send email via an email server that requires user authentication. This method prevents unauthorised users from accessing the email server.

You can use the SMTP-AUTH method for email notification and email reports.



We recommend using Web Based Management to configure the SMTP authentication.

### Email Server Settings

You must configure your machine's SMTP authentication method to match the method used by your email server. For details about your email server settings, contact your network administrator or Internet Service Provider (ISP).



To enable SMTP server authentication, in the Web Based Management **SMTP** screen, under **Server Authentication Method**, you must select **SMTP-AUTH**.



### Related Information

- [Send an Email Securely](#)

## Send an Email Securely Using SSL/TLS

**Related Models:** HL-L2350DW/HL-L2357DW/HL-L2370DN/HL-L2375DW

Your Brother machine supports SSL/TLS methods to send an email via an email server that requires secure SSL/TLS communication. To send email via an email server that is using SSL/TLS communication, you must configure SMTP over SSL/TLS.

 We recommend using Web Based Management to configure SSL/TLS.

### Verify Server Certificate

Under **SSL/TLS**, if you choose **SSL** or **TLS**, the **Verify Server Certificate** check box will be selected automatically.

### SMTP

Status: Enabled

---

#### Send E-mail Settings(SMTP)

**Server Address**

**Port**

**Server Authentication Method**  
 None  
 SMTP-AUTH

**SMTP-AUTH Account Name**

**SMTP-AUTH Account Password**  
Enter password   
Retype password

**SSL/TLS**  
 None  
 SSL  
 TLS  
 Verify Server Certificate

**Device E-mail Address**

---

[CA Certificate>>](#)

[E-mail report>>](#)

[Notification>>](#)

---

-  Before you verify the server certificate, you must import the CA certificate issued by the CA that signed the server certificate. Contact your network administrator or your Internet Service Provider (ISP) to confirm if importing a CA certificate is necessary.
- If you do not need to verify the server certificate, clear the **Verify Server Certificate** check box.

---

## Port Number

If you select **SSL**, the **Port** value will be changed to match the protocol. To change the port number manually, type the port number after you choose **SSL/TLS**.

You must configure your machine's SMTP communication method to match the method used by your email server. For details about your email server settings, contact your network administrator or your ISP.

In most cases, the secured webmail services require the following settings:

SMTP	<b>Port</b>	25
	<b>Server Authentication Method</b>	<b>SMTP-AUTH</b>
	<b>SSL/TLS</b>	<b>TLS</b>



### Related Information

- [Send an Email Securely](#)
-

## Mobile

- [Google Cloud Print](#)
- [AirPrint](#)
- [Mobile Printing for Windows®](#)
- [Mopria® Print Service](#)
- [Brother iPrint&Scan for Mobile Devices](#)

## Google Cloud Print

- [Google Cloud Print Overview](#)
- [Before Using Google Cloud Print](#)
- [Print from Google Chrome™ or Chrome OS™](#)
- [Print from Google Drive™ for Mobile](#)
- [Print from Gmail™ Webmail Service for Mobile](#)

## Google Cloud Print Overview

**Related Models:** HL-L2350DW/HL-L2357DW/HL-L2370DN/HL-L2375DW

Google Cloud Print™ is a Google service that allows you to print to a printer registered to your Google account using a network-compatible device (such as a mobile phone or computer) without installing the printer driver on the device.

Printing from Android™ apps requires installing the Google Cloud Print™ app from the Google Play™ Store.

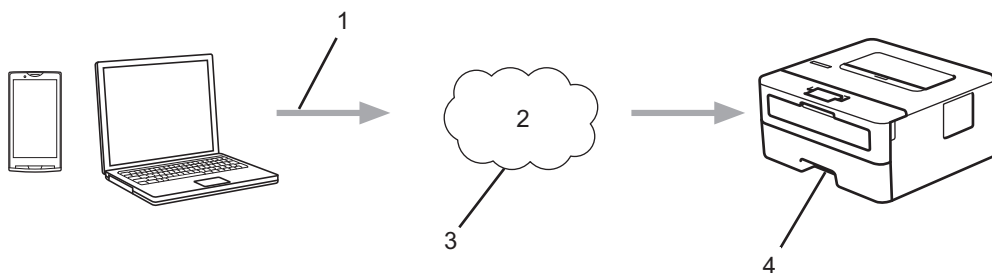

1. Print request
2. Internet
3. Google Cloud Print™
4. Printing



### Related Information

- [Google Cloud Print](#)

## Before Using Google Cloud Print

- [Network Settings for Using Google Cloud Print](#)
- [Register Your Machine with Google Cloud Print Using Google Chrome™](#)
- [Register Your Machine with Google Cloud Print Using Web Based Management](#)



## Network Settings for Using Google Cloud Print

**Related Models:** HL-L2350DW/HL-L2357DW/HL-L2370DN/HL-L2375DW

In order to use Google Cloud Print™, your Brother machine must be connected to a network that has access to the Internet, either through a wired or wireless connection. To connect and configure your machine correctly, see the *Quick Setup Guide* or related topics in this guide.



### Related Information

- [Before Using Google Cloud Print](#)
  - [Google Cloud Print Problems](#)
-

## Register Your Machine with Google Cloud Print Using Google Chrome™

**Related Models:** HL-L2350DW/HL-L2357DW/HL-L2370DN/HL-L2375DW

Make sure you have already created a Google Account. If you do not have an account, use a computer or mobile device to access the Google website (<https://accounts.google.com/signup>) and create an account. Make sure your Brother machine is idle before starting the registration process.



The steps in this section are examples for Windows® users.

Screens on your computer may vary depending on your operating system and environment.

1. Open Google Chrome™ on your computer.
2. Sign in to your Google Account.
3. Click the Google Chrome™ menu icon, and then **Settings > Show advanced settings....**
4. In the **Google Cloud Print** section, click **Manage**.
5. Follow the on-screen instructions to register your machine.
6. When a confirmation message appears on your machine, press the [OK] button.



If the confirmation message does not appear on your machine's LCD, repeat these steps.

7. When your Brother machine is successfully registered, it will appear in the **My devices** field.



### Related Information

- [Before Using Google Cloud Print](#)

## Register Your Machine with Google Cloud Print Using Web Based Management

**Related Models:** HL-L2350DW/HL-L2357DW/HL-L2370DN/HL-L2375DW

Make sure you have already created a Google Account. If you do not have an account, use a computer or mobile device to access the Google website (<https://accounts.google.com/signup>) and create an account. Make sure your Brother machine is idle before starting the registration process. Before you begin to register your machine, confirm that the correct date and time are set on the machine.

1. Confirm that your Brother machine is connected to the same network as your computer or mobile device.
2. Start your web browser.
3. Type "http://machine's IP address" in your browser's address bar (where "machine's IP address" is the machine's IP address).  
For example:  
http://192.168.1.2
4. No password is required by default. Type a password if you have set one, and then click .
5. Click the **Network** tab.
6. Click the **Protocol** menu in the left navigation bar.
7. Make sure that **Google Cloud Print** is selected, and then click **Advanced Settings**.
8. Make sure that **Status** is set to **Enabled**. Click **Register**.
9. Follow the on-screen instructions to register your machine.
10. When a confirmation message appears on your machine, press the OK button.



If the confirmation message does not appear on your machine's LCD, repeat these steps.

11. Click **Google**.
12. The sign-in screen for Google Cloud Print™ appears. Sign in with your Google Account and follow the on-screen instructions to register your machine.
13. When you have finished registering your machine, return to the Web Based Management screen and make sure that **Registration Status** is set to **Registered**.



### Related Information

- [Before Using Google Cloud Print](#)

## Print from Google Chrome™ or Chrome OS™

**Related Models:** HL-L2350DW/HL-L2357DW/HL-L2370DN/HL-L2375DW

1. Make sure your Brother machine is turned on.
2. Open the web page that you want to print.
3. Click the Google Chrome™ menu icon.
4. Click **Print**.
5. Select your machine from the printer list.
6. Change print options, if needed.
7. Click **Print**.



### Related Information

- [Google Cloud Print](#)

## Print from Google Drive™ for Mobile

**Related Models:** HL-L2350DW/HL-L2357DW/HL-L2370DN/HL-L2375DW

1. Make sure your Brother machine is turned on.
2. Access Google Drive™ from your Android™ or iOS device's web browser.
3. Open the document that you want to print.
4. Tap the menu icon.
5. Tap **Print**.
6. Select your machine from the printer list.
7. Change print options, if needed.
8. Tap  or **Print**.

### Related Information

- [Google Cloud Print](#)

## Print from Gmail™ Webmail Service for Mobile

**Related Models:** HL-L2350DW/HL-L2357DW/HL-L2370DN/HL-L2375DW

1. Make sure your Brother machine is turned on.
2. Access the Gmail™ webmail service from your Android™ or iOS device's web browser.
3. Open the email that you want to print.
4. Tap the menu icon.



If **Print** appears beside the attachment name, you can also print the attachment. Tap **Print**, and then follow the instructions on your mobile device.

5. Tap **Print**.
6. Select your machine from the printer list.
7. Change print options, if needed.
8. Tap  or **Print**.



### Related Information

- [Google Cloud Print](#)

## AirPrint

- [AirPrint Overview](#)
- [Before Using AirPrint](#)
- [Print Using AirPrint](#)

## AirPrint Overview

**Related Models:** HL-L2350DW/HL-L2357DW/HL-L2370DN/HL-L2375DW

AirPrint is a printing solution for Apple operating systems that allows you to wirelessly print photos, email, web pages and documents from your iPad, iPhone, iPod touch and Mac computer without the need to install a driver. For more information, visit Apple's website.



### Related Information

- [AirPrint](#)
  - [AirPrint Problems](#)
-



## Before Using AirPrint

- [Network Settings for Using AirPrint](#)
- [Disable and Enable AirPrint Using Web Based Management \(Web Browser\)](#)

## Network Settings for Using AirPrint

**Related Models:** HL-L2350DW/HL-L2357DW/HL-L2370DN/HL-L2375DW

In order to use AirPrint, your mobile device must connect to the wireless network to which your Brother machine is connected. AirPrint supports wireless connections that use infrastructure mode or Wi-Fi Direct®.

To configure your mobile device for a wireless network, refer to your mobile device's user's guide. A link to your mobile device's user's guide on Apple's website can be found by tapping  in Safari.

To configure your Brother machine for a wireless network, see the *Quick Setup Guide* or related topics in this guide. If your Brother machine supports a wired network, you can use a network cable to connect to the wireless access point/router.

If your Brother machine supports Wi-Fi Direct and you want to configure your Brother machine for a Wi-Fi Direct network, see related topics in this Online Guide.



### Related Information

- [Before Using AirPrint](#)

## Disable and Enable AirPrint Using Web Based Management (Web Browser)

**Related Models:** HL-L2350DW/HL-L2357DW/HL-L2370DN/HL-L2375DW

Confirm that your Brother machine is connected to the same network as your computer.

1. Start your web browser.
2. Type "http://machine's IP address" in your browser's address bar (where "machine's IP address" is the machine's IP address).  
For example:  
http://192.168.1.2
3. No password is required by default. Type a password if you have set one, and then click .
4. Click the **Network** tab.
5. Click the **Protocol** menu in the left navigation bar.
6. To disable AirPrint, clear the **AirPrint** check box. To enable AirPrint, select the **AirPrint** check box.



By default, AirPrint is enabled.

7. Click **Submit**.
8. Restart your machine to activate the configuration.



### Related Information

- [Before Using AirPrint](#)



## Print Using AirPrint

- [Print from iPad, iPhone, or iPod Touch](#)
- [Before Using AirPrint \(macOS\)](#)
- [Print Using AirPrint \(macOS\)](#)

## Print from iPad, iPhone, or iPod Touch

**Related Models:** HL-L2350DW/HL-L2357DW/HL-L2370DN/HL-L2375DW

The procedure used to print may vary by application. Safari is used in the example below.

1. Make sure your Brother machine is turned on.
2. Use Safari to open the page that you want to print.
3. Tap  or .
4. Tap **Print**.
5. Make sure your Brother machine is selected.
6. If a different machine (or no printer) is selected, tap **Printer**.  
A list of available machines appears.
7. Tap your machine's name in the list.
8. Select the desired options, such as the number of pages to print and 2-sided printing (if supported by your machine).
9. Tap **Print**.



### Related Information

- [Print Using AirPrint](#)

## Before Using AirPrint (macOS)

**Related Models:** HL-L2350DW/HL-L2357DW/HL-L2370DN/HL-L2375DW

Before printing using macOS, add your Brother machine to the printer list on your Mac computer.

1. Select **System Preferences** from the Apple Menu.
2. Click **Printers & Scanners**.
3. Click the + icon below the Printers pane on the left.
4. Click **Add Printer or Scanner...** The **Add** screen appears.
5. Select your Brother machine, and then select **AirPrint** from the **Use** pop-up menu.
6. Click **Add**.



### Related Information

- [Print Using AirPrint](#)

## Print Using AirPrint (macOS)

**Related Models:** HL-L2350DW/HL-L2357DW/HL-L2370DN/HL-L2375DW

The procedure used to print may vary by application. Safari is used in the example below. Before printing, make sure your Brother machine is in the printer list on your Mac computer.

1. Make sure your Brother machine is turned on.
2. On your Mac computer, use Safari to open the page that you want to print.
3. Click the **File** menu, and then select **Print**.
4. Make sure your Brother machine is selected. If a different machine (or no printer) is selected, click the **Printer** pop-up menu, and then select your Brother machine.
5. Select the desired options, such as the number of pages to print and 2-sided printing (if supported by your machine).
6. Click **Print**.

### ✓ Related Information

- [Print Using AirPrint](#)

## Mobile Printing for Windows®

**Related Models:** HL-L2350DW/HL-L2357DW/HL-L2370DN/HL-L2375DW

Mobile printing for Windows® is a function to print wirelessly from your Windows® mobile device. You can connect to the same network that your Brother machine is connected to and print without installing the printer driver on the device. Many Windows® apps support this function.

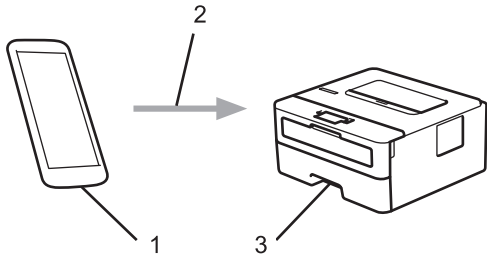

1. Windows® mobile device (Windows® 10 Mobile or later)
2. Wi-Fi® connection
3. Your Brother machine



### Related Information

- [Mobile](#)



## Mopria® Print Service

**Related Models:** HL-L2350DW/HL-L2357DW/HL-L2370DN/HL-L2375DW

Mopria® Print Service is a print feature on Android™ mobile devices (Android™ version 4.4 or later) developed by the Mopria® Alliance. With this service, you can connect to the same network as your machine and print without additional setup. Many native Android™ apps support printing.

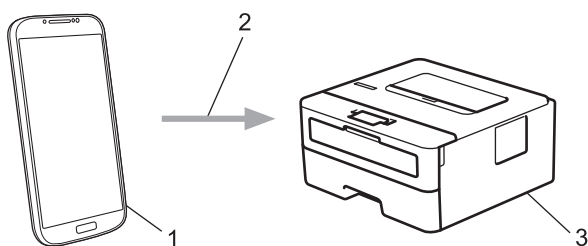

1. Android™ 4.4 or later
2. Wi-Fi® Connection
3. Your Brother machine

You must download the Mopria® Print Service from the Google Play™ Store and install it on your Android™ device. Before using this service, you must turn it on.

### ✓ Related Information

- [Mobile](#)

## Brother iPrint&Scan for Mobile Devices

**Related Models:** HL-L2350DW/HL-L2357DW/HL-L2370DN/HL-L2375DW

Use Brother iPrint&Scan to print from various mobile devices.

- For Android™ Devices

Brother iPrint&Scan allows you to use features of your Brother machine directly from your Android™ device, without using a computer.

Download and install Brother iPrint&Scan from the Google Play™ Store app.

- For all iOS supported devices including iPhone, iPad and iPod touch

Brother iPrint&Scan allows you to use features of your Brother machine directly from your iOS device.

Download and install Brother iPrint&Scan from the App Store.

- For Windows® Devices

Brother iPrint&Scan allows you to use features of your Brother machine directly from your Windows® device, without using a computer.

Download and install Brother iPrint&Scan from the Microsoft® Store.

For more detailed information, visit [support.brother.com/ips](http://support.brother.com/ips).



### Related Information

- [Mobile](#)
- [Brother iPrint&Scan Overview](#)

## Brother iPrint&Scan for Windows® and Mac

- [Brother iPrint&Scan Overview](#)

## Brother iPrint&Scan Overview

Use Brother iPrint&Scan for Windows® and Mac to print from your computer.

The following screen shows an example of Brother iPrint&Scan for Windows®. The actual screen may differ depending on the version of the application.

- For Windows®  
Go to your model's **Downloads** page on the Brother Solutions Center at [support.brother.com](http://support.brother.com) to download the latest application.
- For Mac  
Download and install Brother iPrint&Scan from the App Store.

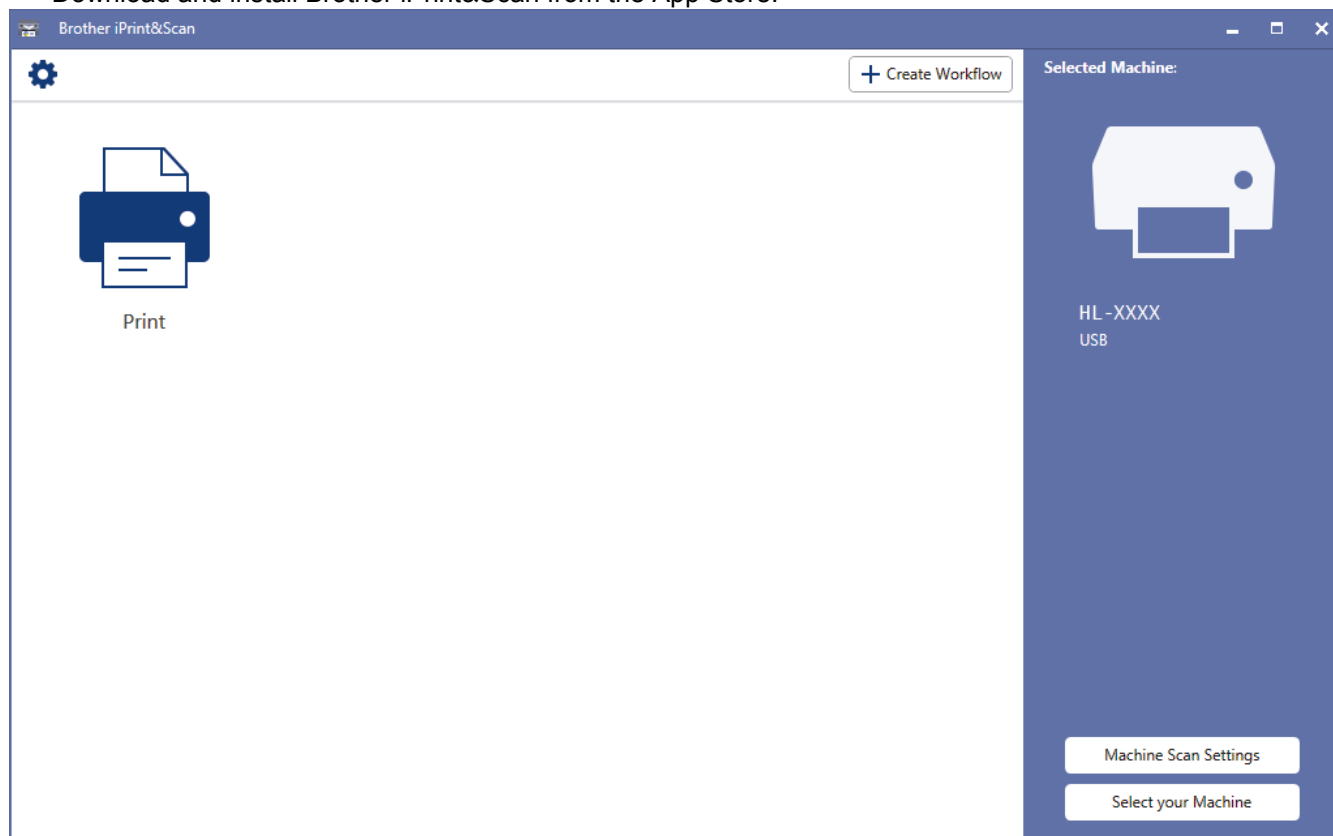

### ✓ Related Information

- [Brother iPrint&Scan for Windows® and Mac](#)
- [Brother iPrint&Scan for Mobile Devices](#)

## Troubleshooting

Use this section to resolve typical problems you may encounter when using your Brother machine. You can correct most problems yourself.

### IMPORTANT

For technical help, you must call Brother customer service or your local Brother dealer.  
Using non-Brother supplies may affect the print quality, hardware performance, and machine reliability.



If you need additional help, go to the Brother Solutions Center at [support.brother.com](http://support.brother.com).

First, check the following:

- The machine's power cord is connected correctly and the machine's power is on. See the *Quick Setup Guide*.
- All of the protective materials have been removed. See the *Quick Setup Guide*.
- Paper is loaded correctly in the paper tray.
- The interface cables are securely connected to the machine and the computer, or the wireless connection is set up on both the machine and your computer.
- Error and maintenance messages

If you did not solve the problem with the checks, identify the problem and then see *Related Information*.



### Related Information





- [Error and Maintenance Indications](#)
- [Error and Maintenance Messages](#)
- [Paper Jams](#)
- [Printing Problems](#)
- [Improve the Print Quality](#)
- [Network Problems](#)
- [Google Cloud Print Problems](#)
- [AirPrint Problems](#)
- [Other Problems](#)
- [Machine Information](#)







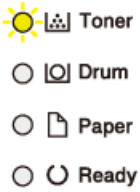

## Error and Maintenance Indications















Related Models: HL-L2310D

As with any sophisticated office product, errors may occur and supply items may have to be replaced. If this happens, your machine identifies the error or required routine maintenance and the Status Monitor indicates the appropriate message. The most common error and maintenance indications are shown in the table.

Follow the instructions in the Actions to improve the status.

LED Indication	Status Monitor	Cause	Action
	<b>Toner Low</b>	If the Status Monitor shows <b>Toner Low</b> you can still print; however, the machine is telling you that the toner cartridge is near the end of its life.	Order a new toner cartridge now so a replacement toner cartridge will be available when the Status Monitor displays <b>Replace Toner</b> .
	<b>Replace Toner</b>	The toner cartridge is at the end of its life. The machine stops all print operations.	Replace the toner cartridge with a new one.
	<b>Cartridge Error</b>	The toner cartridge is not installed correctly.	Remove the toner cartridge and drum unit assembly from the machine. Take out the toner cartridge, and put it back in the drum unit again. Reinstall the toner cartridge and drum unit assembly back in the machine. If the problem continues, contact Brother customer service or your local Brother dealer.
	<b>No Toner</b>	The toner cartridge or the toner cartridge and drum unit assembly is not installed correctly.	Remove the toner cartridge and drum unit assembly. Remove the toner cartridge from the drum unit, and reinstall the toner cartridge back in the drum unit. Reinstall the toner cartridge and drum unit assembly back in the machine. If the problem continues, replace the toner cartridge with a new one.
	<b>Drum !</b>	The corona wire on the drum unit must be cleaned.	Clean the corona wire on the drum unit.
		The drum unit or the toner cartridge and drum unit assembly is not installed correctly.	Remove the toner cartridge and drum unit assembly, remove the toner cartridge from the drum unit, and reinstall the toner cartridge back into the drum unit. Reinstall the toner cartridge and drum unit assembly into the machine.

LED Indication	Status Monitor	Cause	Action
			If the problem continues, replace the drum unit with a new one.
<ul style="list-style-type: none"> <li><input type="radio"/>  Toner</li> <li><input checked="" type="radio"/>  Drum</li> <li><input type="radio"/>  Paper</li> <li><input checked="" type="radio"/>  Ready</li> </ul>	<b>Replace Drum</b>	It is time to replace the drum unit.	Replace the drum unit with a new one.
		The drum unit counter was not reset when the previous drum was removed.	Reset the drum unit counter.
<ul style="list-style-type: none"> <li><input type="radio"/>  Toner</li> <li><input type="radio"/>  Drum</li> <li><input checked="" type="radio"/>  Paper</li> <li><input type="radio"/>  Ready</li> </ul>	<b>Cover is Open</b>	The front cover is not completely closed.	Open and then firmly close the front cover of the machine.
		The fuser cover is not completely closed or paper was jammed in the back of the machine when you turned on the power.	<ul style="list-style-type: none"> <li>• Close the fuser cover located inside the back cover of the machine.</li> <li>• Make sure paper is not jammed inside the back cover of the machine, and then close the fuser cover.</li> </ul>
	<b>2-sided Disabled</b> (For automatic 2-sided printing models)	The back cover of the machine is not closed completely.	Close the back cover of the machine until it locks in the closed position.
		The 2-sided tray is not installed completely.	Install the 2-sided tray firmly in the machine.
	<b>Jam 2-sided</b> (For automatic 2-sided printing models)	The paper is jammed underneath the 2-sided tray or the fuser unit.	Clear the Jam in the 2-sided tray or the fuser unit.
	<b>Jam Inside</b>	The paper is jammed inside the machine.	Open the front cover, remove the drum and toner, and clear the paper jam.
	<b>Jam Rear</b>	The paper is jammed in the back of the machine.	Open the fuser cover and remove all jammed paper. Close the fuser cover.
	<b>Jam Tray</b>	The paper is jammed in the paper tray.	Pull the paper tray out completely, open the front cover and fuser cover to remove all jammed paper.
	<b>Out of Memory</b>	The machine's memory is full.	Reduce the print resolution.
	<b>Size Error DX</b> (For automatic 2-sided printing models)	The paper size specified in the printer driver is not available for automatic 2-sided printing.	Press <b>Go</b> . Choose a paper size which is supported by the duplex tray.  Paper size available for automatic 2-sided printing is A4.
The paper in the tray is not the correct size and is not available for automatic 2-sided printing.		Load the correct size of paper in the tray and set the tray for that paper size.  Paper size available for automatic 2-sided printing is A4.	
<b>Size Mismatch</b>	The paper in the tray is not the correct size.	Load the correct size of paper in the tray and set the size of paper to the tray.	

LED Indication	Status Monitor	Cause	Action
<ul style="list-style-type: none"> <li><input type="radio"/>  Toner</li> <li><input type="radio"/>  Drum</li> <li><input checked="" type="radio"/>  Paper</li> <li><input type="radio"/>  Ready</li> </ul>	<b>Manual Feed</b>	<b>Manual</b> was selected as the paper source in the printer driver, but there is no paper in the manual feed slot.	Place paper in the manual feed slot.
	<b>No Paper</b>	The machine is out of paper, or paper is not loaded correctly in the paper tray.	<ul style="list-style-type: none"> <li>• Refill paper in the paper tray. Make sure the paper guides are set to the correct size.</li> <li>• If paper is in the tray, remove it and load it again. Make sure the paper guides are set to the correct size.</li> </ul>
<ul style="list-style-type: none"> <li><input checked="" type="radio"/>  Toner</li> <li><input type="radio"/>  Drum</li> <li><input checked="" type="radio"/>  Paper</li> <li><input type="radio"/>  Ready</li> </ul>	<b>Toner Ended</b> (Continue mode)	It is time to replace the toner cartridge.	Replace the toner cartridge with a new one.
<ul style="list-style-type: none"> <li><input checked="" type="radio"/>  Toner</li> <li><input checked="" type="radio"/>  Drum</li> <li><input checked="" type="radio"/>  Paper</li> <li><input checked="" type="radio"/>  Ready</li> </ul>	<b>Self-Diagnostic</b>	<p>The temperature of the fuser unit does not rise to a specified temperature within the specified time.</p> <p>The fuser unit is too hot.</p>	Press and hold  to turn the machine off, wait a few seconds, and then turn it on again. Leave the machine idle for 15 minutes with the power on.
	<b>Print Unable</b>	The machine has a mechanical problem.	<ul style="list-style-type: none"> <li>• Press and hold  to turn the machine off, wait a few minutes, and then turn it on again.</li> <li>• If the problem continues, contact Brother customer service.</li> </ul>

## ✓ Related Information

- [Troubleshooting](#)
- [Replace Supplies](#)
- [Replace the Drum Unit](#)
- [Clean the Corona Wire](#)





## Error and Maintenance Messages

As with any sophisticated office product, errors may occur and supply items may have to be replaced. If this happens, your machine identifies the error or required routine maintenance and shows the appropriate message. The most common error and maintenance messages are shown in the table.

Follow the instructions in the **Action** column to solve the error and remove the message.

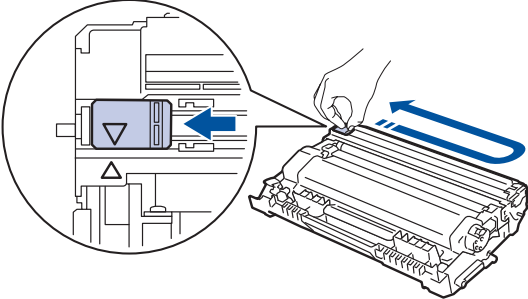
You can correct most errors and perform routine maintenance by yourself. If you need more tips: Visit [support.brother.com](http://support.brother.com), and click the **FAQs & Troubleshooting** page.

Error Message	Cause	Action
2-sided Disabled	The back cover of the machine is not closed completely.	Close the back cover of the machine until it locks in the closed position.
	The 2-sided tray is not installed completely.	Install the 2-sided tray firmly in the machine.
Cartridge Error	The toner cartridge is not installed correctly.	Remove the toner cartridge and drum unit assembly. Take out the toner cartridge, and put it back in the drum unit again. Reinstall the toner cartridge and drum unit assembly in the machine.  If the problem continues, contact Brother customer service or your local Brother dealer.
Cooling Down	The temperature of the inside of the machine is too hot. The machine pauses its current print job and goes into cooling down mode.	Wait until the machine has finished cooling down. Make sure all vents on the machine are clear of obstructions.  When the machine has cooled down, the machine will resume printing.  If the fan is not spinning, disconnect the machine from the power for several minutes, then reconnect it.
Cover is Open	The front cover is not completely closed.	Open and then firmly close the front cover of the machine.
Cover is Open	The fuser cover is not completely closed.	Close the fuser cover located inside the back cover of the machine.
Drum !	The corona wire on the drum unit must be cleaned.	Clean the corona wire on the drum unit.    <i>See Related Information: Clean the Corona Wire.</i>  If the problem continues, replace the drum unit with a new one.
	The drum unit or the toner cartridge and drum unit assembly is not installed correctly.	Remove the drum unit, remove the toner cartridge from the drum unit, and put the toner cartridge back into the drum unit. Reinstall the drum unit in the machine.
Drum End Soon	The drum unit is near the end of its life.	Order a new drum unit before the LCD displays <code>Replace Drum</code> .

Error Message	Cause	Action
Jam 2-sided	The paper is jammed in the 2-sided tray or inside the back cover.	Remove the 2-sided tray and open the back cover to pull out all jammed paper.
Jam Inside	The paper is jammed inside the machine.	Open the front cover, remove the toner cartridge and drum unit assembly, and pull out all jammed paper. Close the front cover.
Jam Rear	The paper is jammed in the back of the machine.	Open the fuser cover and remove all jammed paper. Close the fuser cover.
Jam Tray 1	The paper is jammed in the indicated paper tray.	Pull out the paper tray indicated on the LCD and remove all jammed paper.
Manual Feed	<b>Manual</b> was selected as the paper source in the printer driver, but there is no paper in the manual feed slot.	Place paper in the manual feed slot.
Media Mismatch	The media type specified in the printer driver differs from the paper type specified in the machine's menu.	Load the correct type of paper in the tray indicated on the LCD, and then select the correct media type in the Paper Type setting on the machine.
No Drum Unit	The drum unit is not installed correctly.	Reinstall the toner cartridge and drum unit assembly.
No Paper	The machine is out of paper, or paper is not loaded correctly in the paper tray.	<ul style="list-style-type: none"> <li>• Refill paper in the paper tray. Make sure the paper guides are set to the correct size.</li> <li>• If paper is in the tray, remove it and load it again. Make sure the paper guides are set to the correct size.</li> <li>• Do not overfill the paper tray.</li> </ul>
No Paper T1	The machine failed to feed paper from the indicated paper tray.	<p>Do one of the following:</p> <ul style="list-style-type: none"> <li>• Refill paper in the paper tray indicated on the LCD. Make sure the paper guides are set to the correct size.</li> <li>• If paper is in the tray, remove it and load it again. Make sure the paper guides are set to the correct size.</li> <li>• Do not overfill the paper tray.</li> </ul>
No Toner	The toner cartridge or the toner cartridge and drum unit assembly is not installed correctly.	Remove the toner cartridge and drum unit assembly. Remove the toner cartridge from the drum unit, and reinstall the toner cartridge back in the drum unit. Reinstall the toner cartridge and drum unit assembly back in the machine. If the problem continues, replace the toner cartridge with a new one.
Out of Memory	The machine's memory is full.	Press and hold <b>Go</b> for about two seconds and reduce the print resolution.
Print Data Full	The machine's memory is full.	Press and hold <b>Go</b> for about two seconds and delete the previously stored print data.
Print Unable ##	The machine has a mechanical problem.	<ul style="list-style-type: none"> <li>• Press and hold  to turn the machine off, wait a few minutes, and then turn it on again.</li> <li>• If the problem continues, contact Brother customer service.</li> </ul>

Error Message	Cause	Action
Replace Drum	It is time to replace the drum unit.	Replace the drum unit with a new one. See <i>Related Information: Replace the Drum Unit</i> .
	The drum unit counter was not reset when a new drum was installed.	Reset the drum unit counter. See the instructions included with the new drum unit.
Replace Toner	The toner cartridge is at the end of its life. The machine stops all print operations.	Replace the toner cartridge with a new one.
Self-Diagnostic	The temperature of the fuser unit does not rise to a specified temperature within the specified time.	Press and hold  to turn the machine off, wait a few seconds, and then turn it on again. Leave the machine idle for 15 minutes with the power on.
	The fuser unit is too hot.	
Size Error	The paper size defined in the printer driver is not supported by the defined tray.	Choose a paper size supported by the defined tray.
Size Error DX	The paper size specified in the machine's paper size setting is not available for automatic 2-sided printing.	Press and hold <b>Go</b> for about two seconds (if required). Load the correct size of paper in the tray and set the tray for that paper size.
	The paper in the tray is not the correct size and is not available for automatic 2-sided printing.	Choose a paper size supported by 2-sided printing. Paper size available for automatic 2-sided printing is A4.
Size Mismatch	The paper in the tray is not the correct size.	Load the correct size of paper in the tray indicated on the LCD and set the size of paper for the tray. Press <b>Go</b> .
Toner Ended	It is time to replace the toner cartridge.	Replace the toner cartridge with a new one.
Toner Low	If the LCD displays this message, you can still print. The toner cartridge is near the end of its life.	Order a new toner cartridge now so you have it ready when the LCD displays <i>Replace Toner</i> .



## Related Information

- [Troubleshooting](#)
- [Replace Supplies](#)
- [Replace the Drum Unit](#)
- [Clean the Corona Wire](#)

## Paper Jams

Always remove the remaining paper from the paper tray and straighten the stack when you are adding new paper. This helps prevent multiple sheets of paper from feeding through the machine at one time and prevents paper jams.

- [Paper is Jammed in the Paper Tray](#)
- [Paper is Jammed in the Back of the Machine](#)
- [Paper is Jammed inside the Machine](#)
- [Paper is Jammed in the 2-sided Tray](#)

## Paper is Jammed in the Paper Tray

If the machine's control panel or the Status Monitor indicates that there is a jam in the paper tray, follow these steps:

1. Pull the paper tray completely out of the machine.

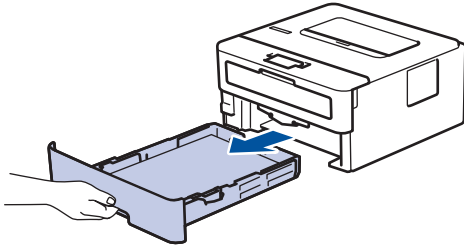

2. Slowly pull out the jammed paper.

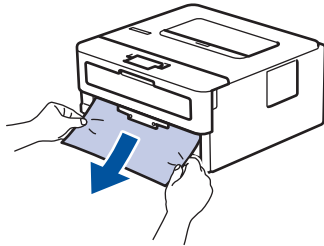

Pulling the jammed paper downward using both hands allows you to remove the paper more easily.

3. Fan the stack of paper to prevent further jams, and slide the paper guides to fit the paper size.

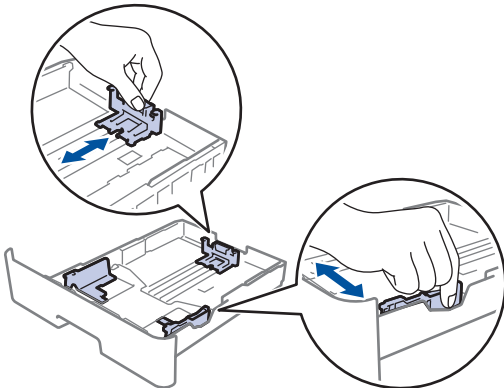

4. Make sure the paper is below the maximum paper mark (▼▼▼).

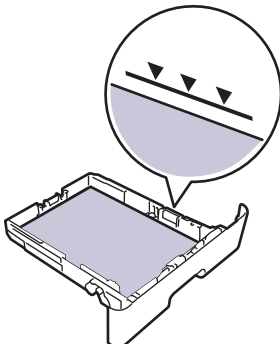

5. Put the paper tray firmly back in the machine.



### Related Information

- [Paper Jams](#)

## Paper is Jammed in the Back of the Machine

If the machine's control panel or the Status Monitor indicates that there is a jam in the back (Rear) of the machine, follow these steps:

1. Leave the machine turned on for 10 minutes for the internal fan to cool the extremely hot parts inside the machine.
2. Open the back cover.

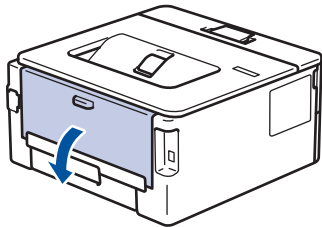

3. Pull the blue tabs at the left and right sides toward you to release the fuser cover.

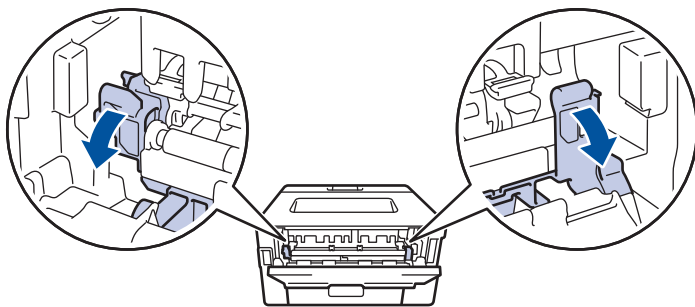

### WARNING

#### HOT SURFACE

The machine's internal parts will be extremely hot. Wait for the machine to cool down before touching them.

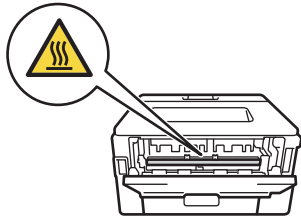

 If the green envelope levers inside the back cover are pulled down to the envelope position, lift these levers to the original position before pulling the green tabs down.

4. Use both hands to gently pull the jammed paper out of the fuser unit.

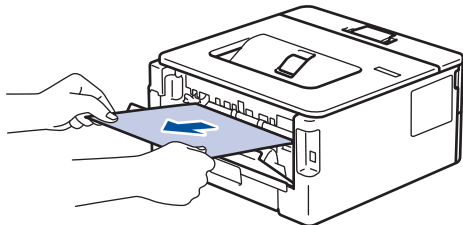

---

5. Close the fuser cover.

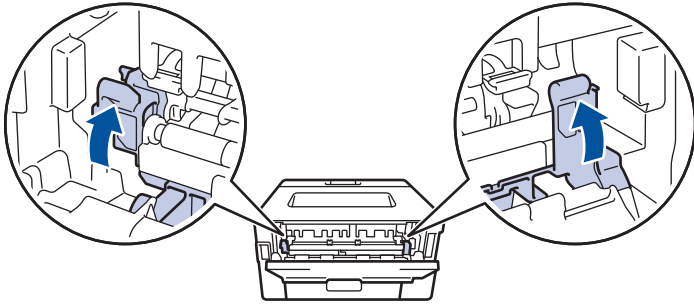

If you print on envelopes, pull down the green envelope levers to the envelope position again before closing the back cover.

---

6. Close the back cover until it locks in the closed position.



### Related Information

- [Paper Jams](#)
-

## Paper is Jammed inside the Machine

If the machine's control panel or the Status Monitor indicates that there is a jam inside the machine, follow these steps:

1. Leave the machine turned on for 10 minutes for the internal fan to cool the extremely hot parts inside the machine.
2. Open the front cover.

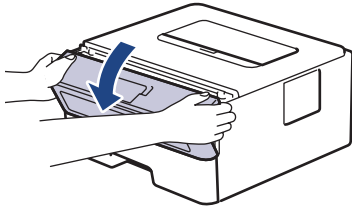

3. Remove the toner cartridge and drum unit assembly.

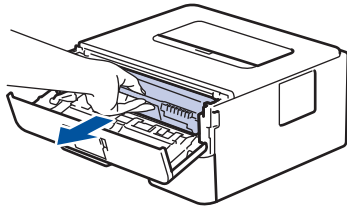

### WARNING

#### HOT SURFACE

The machine's internal parts will be extremely hot. Wait for the machine to cool down before touching them.

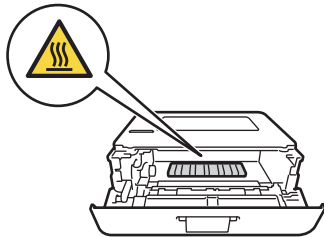

4. Pull out the jammed paper slowly.

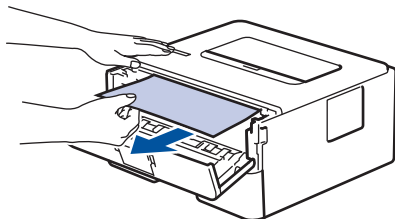

5. Install the toner cartridge and drum unit assembly into the machine.

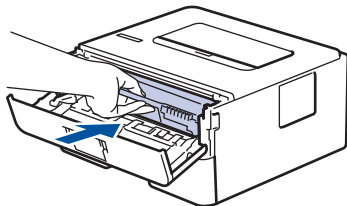

6. Close the front cover.

### Related Information

- [Paper Jams](#)



## Paper is Jammed in the 2-sided Tray

If the machine's control panel or the Status Monitor indicates that there is a jam in the 2-sided paper tray, follow these steps:

1. Leave the machine turned on for 10 minutes for the internal fan to cool the extremely hot parts inside the machine.
2. Pull the paper tray completely out of the machine.

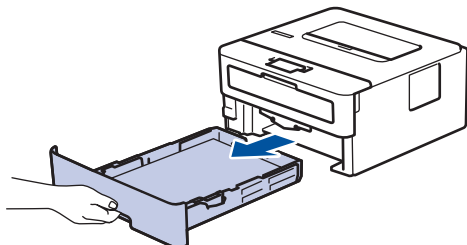

3. At the back of the machine, pull the 2-sided tray completely out of the machine.

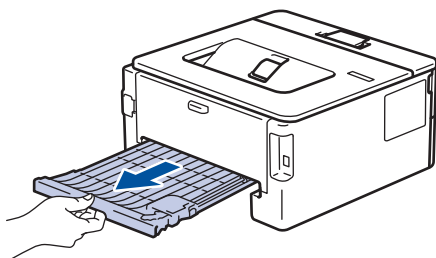

4. Pull the jammed paper out of the machine or out of the 2-sided tray.

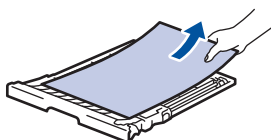
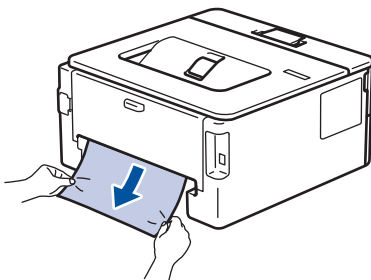

5. Remove paper that may have jammed under the machine due to static electricity.

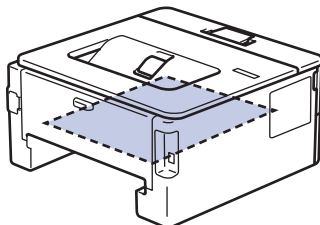

- 
6. If paper is not caught inside the 2-sided tray, open the back cover.

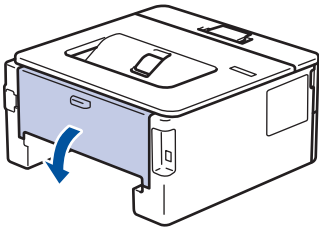

## **WARNING**

### HOT SURFACE

The machine's internal parts will be extremely hot. Wait for the machine to cool down before touching them.

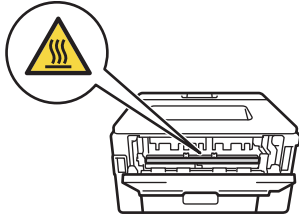

- 
7. Use both hands to gently pull the jammed paper out of the back of the machine.

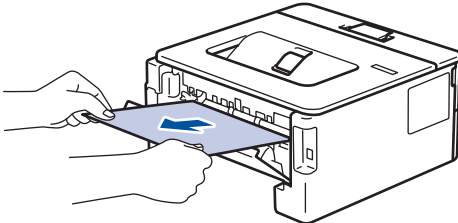







8. Close the back cover until it locks in the closed position.  
9. Put the 2-sided tray firmly back in the rear of the machine.  
10. Put the paper tray firmly back in the front of the machine.

## **Related Information**

- [Paper Jams](#)

## Printing Problems

Difficulties	Suggestions
No printout	<p>Check the machine is not in Power Off mode.</p> <p>If the machine is in Power Off mode, press  on the control panel, and then send the print data again.</p> <p>Check that the correct printer driver has been installed and selected.</p> <p>Check to see if the Status Monitor or the machine's control panel displays an error status.</p> <p>Check that the machine is online:</p> <ul style="list-style-type: none"> <li>• Windows® 7 and Windows Server® 2008 R2           <p>Click  (<b>Start</b>) &gt; <b>Devices and Printers</b>. Right-click <b>Brother XXX-XXXX</b> and click <b>See what's printing</b>. Click <b>Printer</b> in the menu bar. Make sure <b>Use Printer Offline</b> is not selected.</p> </li> <li>• Windows Server® 2008           <p>Click  (<b>Start</b>) &gt; <b>Control Panel</b> &gt; <b>Hardware and Sound</b> &gt; <b>Printers</b>. Right-click <b>Brother XXX-XXXX</b>. Make sure <b>Use Printer Online</b> is not listed. If it is listed, click this option to set the driver Online.</p> </li> <li>• Windows® 8 and Windows Server® 2012           <p>Move your mouse to the lower right corner of your desktop. When the menu bar appears, click <b>Settings</b> &gt; <b>Control Panel</b> &gt; <b>Hardware and Sound</b> &gt; <b>View devices and printers</b>. Right-click the <b>Brother XXX-XXXX</b>. Click <b>See what's printing</b>. If printer driver options appear, select your printer driver. Click <b>Printer</b> in the menu bar and make sure that <b>Use Printer Offline</b> is not selected.</p> </li> <li>• Windows® 10 and Windows Server® 2016           <p>Click  &gt; <b>Windows System</b> &gt; <b>Control Panel</b>. In the <b>Hardware and Sound</b> group, click <b>View devices and printers</b>. Right-click the <b>Brother XXX-XXXX</b>. Click <b>See what's printing</b>. If printer driver options appear, select your printer driver. Click <b>Printer</b> in the menu bar and make sure that <b>Use Printer Offline</b> is not selected.</p> </li> <li>• Windows Server® 2012 R2           <p>Click <b>Control Panel</b> on the <b>Start</b> screen. In the <b>Hardware</b> group, click <b>View devices and printers</b>. Right-click the <b>Brother XXX-XXXX</b>. Click <b>See what's printing</b>. If printer driver options appear, select your printer driver. Click <b>Printer</b> in the menu bar and make sure <b>Use Printer Offline</b> is not selected.</p> </li> <li>• Mac           <p>Click the <b>System Preferences</b> menu, and then select the <b>Printers &amp; Scanners</b> option. When the machine is offline, delete it using the  button, and then add it using the  button.</p> </li> </ul>

Difficulties	Suggestions
The machine is not printing or has stopped printing.	Cancel the print job and clear it from the machine's memory. The printout may be incomplete. Send the print data again. <i>See Related Information:Cancel a Print Job.</i>
The headers or footers appear when the document displays on the screen but they do not show up when it is printed.	There is an unprintable area on the top and bottom of the page. Adjust the top and bottom margins in your document to allow for this.
The machine prints unexpectedly or it prints garbage.	Cancel the print job and clear it from the machine's memory. The printout may be incomplete. Send the print data again. <i>See Related Information:Cancel a Print Job.</i>
	Check the settings in your application to make sure they are set up to work with your machine.
	Confirm that the Brother printer driver is selected in your application's Print window.
The machine prints the first couple of pages correctly, then some pages have missing text.	Check the settings in your application to make sure they are set up to work with your machine.
	Your machine is not receiving all of the data sent from the computer. Make sure you connected the interface cable correctly.
The machine does not print on both sides of the paper even though the printer driver setting is 2-sided and the machine supports automatic 2-sided printing.	Check the paper size setting in the printer driver. You must select A4 paper that is 60 to 105 g/m <sup>2</sup> .
Print speed is too slow.	Try changing the printer driver setting. The highest resolution needs longer data processing, sending and printing time.
	If you have enabled the Quiet Mode, disable the Quiet Mode on the printer driver or the machine's menu setting.
The machine does not feed paper.	If there is paper in the paper tray, make sure it is straight. If the paper is curled, straighten it. Sometimes it is helpful to remove the paper, turn the stack over and place it back in the paper tray.
	Reduce the amount of paper in the paper tray, and then try again.
	(For models with Manual Feed Slot)Make sure <b>Manual</b> is not selected for <b>Paper Source</b> in the printer driver.
	Clean the paper pick-up rollers.
The machine does not feed paper from the Manual feed slot. (For models with Manual Feed Slot)	Use both hands to push one sheet of paper firmly into the manual feed slot until the top edge of the paper presses against the paper feed rollers. Continue pressing the paper against the rollers until the machine grabs the paper and pulls it in further.
	Put only one sheet of paper in the manual feed slot.
	Make sure <b>Manual</b> is selected as <b>Paper Source</b> in the printer driver.
The machine does not feed envelopes.	(For models with Manual Feed Slot)Load one envelope at a time in the manual feed slot. Your application must be set to print the envelope size you are using. This is usually done in the Page Setup or Document Setup menu of your application.



## Related Information

- [Troubleshooting](#)

- 
- Monitor the Status of the Machine from Your Computer (Windows®)
  - Monitor the Status of the Machine from Your Computer (Mac)
  - Cancel a Print Job
  - Clean the Paper Pick-up Rollers
-



## Improve the Print Quality





If you have a print quality problem, print a test page first. If the printout looks good, the problem is probably not the machine. Check the interface cable connections and try printing a different document. If the printout or test page printed from the machine has a quality problem, check the examples of poor print quality and follow the recommendations in the table.



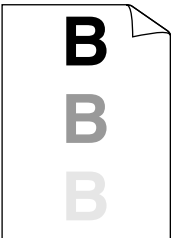

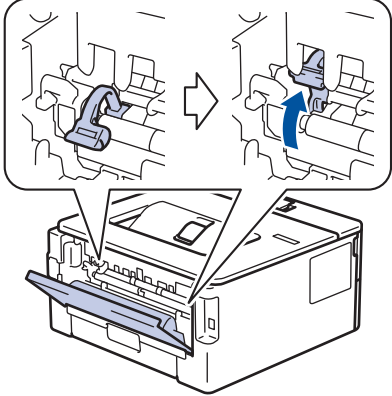
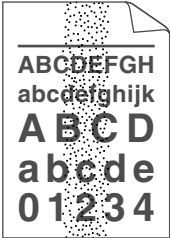
### IMPORTANT

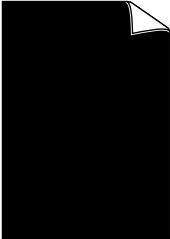
Using non-genuine supplies may affect the print quality, hardware performance, and machine reliability.



1. To get the best print quality, we suggest using recommended print media. Make sure you use paper that meets our specifications.
2. Check that the toner cartridge and drum unit are installed correctly.

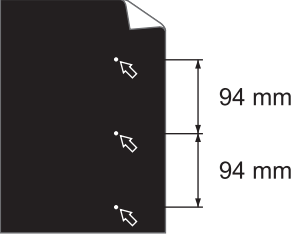
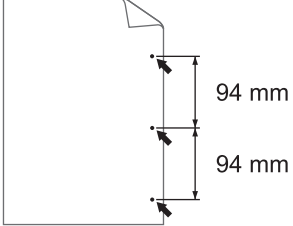

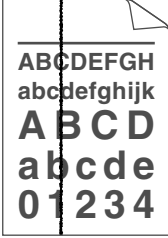
Examples of poor print quality	Recommendation
 <p>ABCDEF GH abcde fghijk A B C D a b c d e 0 1 2 3 4</p> <p>Faint</p>	<ul style="list-style-type: none"> <li>• If the machine indicates Replace Toner status, install a new toner cartridge.</li> <li>• Check the machine's environment. Conditions such as humidity, high temperatures, and so on, may cause this print fault.</li> <li>• If the whole page is too light, Toner Save may be turned on. Turn off Toner Save mode in the machine's menu settings or the printer driver.</li> <li>• Clean the drum unit.</li> <li>• Clean the corona wire on the drum unit.</li> <li>• Replace the toner cartridge with a new toner cartridge.</li> <li>• Replace the drum unit with a new drum unit.</li> </ul>
 <p>ABCDEF GH abcde fghijk A B C D a b c d e 0 1 2 3 4</p> <p>Grey background</p>	<ul style="list-style-type: none"> <li>• Check the machine's environment. Conditions such as high temperatures and high humidity can increase the amount of background shading.</li> <li>• Clean the drum unit.</li> <li>• Replace the toner cartridge with a new toner cartridge.</li> <li>• Replace the drum unit with a new drum unit.</li> </ul>
 <p>B B B</p> <p>Ghosting images</p>	<ul style="list-style-type: none"> <li>• Check the machine's environment. Conditions such as low humidity and low temperatures may cause this print quality problem.</li> <li>• Select the appropriate media type in the printer driver.</li> <li>• (For models with an LCD) Select the appropriate media type in the menu setting.</li> <li>• Make sure the two green levers inside the back cover are in the up position. Pull up the two green levers until they stop.</li> </ul>

Examples of poor print quality	Recommendation
	 <ul style="list-style-type: none"> <li>• Clean the drum unit.</li> <li>• Replace the drum unit with a new drum unit.</li> <li>• Replace the toner cartridge with a new toner cartridge.</li> <li>• The fuser unit may be contaminated. Contact Brother customer service.</li> </ul>
 <p>Toner specks</p>	<ul style="list-style-type: none"> <li>• Make sure the media type setting in the driver matches the type of paper you are using.</li> <li>• Clean the drum unit.</li> <li>• The toner cartridge may be damaged. Replace the toner cartridge with a new toner cartridge.</li> <li>• The drum unit may be damaged. Replace the drum unit with a new drum unit.</li> <li>• The fuser unit may be contaminated. Contact Brother customer service.</li> </ul>
 <p>Hollow print</p>	<ul style="list-style-type: none"> <li>• Select <b>Thick Paper</b> mode in the printer driver or use thinner paper than you are currently using.</li> <li>• (For models with an LCD) Select the appropriate media type in the menu setting.</li> <li>• Check the machine's environment. Conditions such as high humidity can cause hollow print.</li> <li>• The drum unit may be damaged. Replace the drum unit with a new drum unit.</li> </ul>
 <p>All black</p>	<ul style="list-style-type: none"> <li>• Clean the corona wire inside the drum unit.</li> <li>• The drum unit may be damaged. Replace the drum unit with a new drum unit.</li> </ul>
 <p>White lines across the page</p>	<ul style="list-style-type: none"> <li>• Select the appropriate media type in the printer driver.</li> <li>• (For models with an LCD) Select the appropriate media type in the menu setting.</li> <li>• The problem may disappear by itself. Print multiple blank pages to clear this problem, especially if the machine has not been used for a long time.</li> <li>• Clean the drum unit.</li> <li>• The drum unit may be damaged. Replace the drum unit with a new drum unit.</li> </ul>

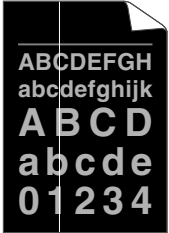
Examples of poor print quality	Recommendation
 <p data-bbox="347 405 601 432">Lines across the page</p>	<ul data-bbox="818 170 1356 280" style="list-style-type: none"> <li>• Clean the drum unit.</li> <li>• The drum unit may be damaged. Replace the drum unit with a new drum unit.</li> </ul>
 <p data-bbox="220 689 730 716">White lines, bands or ribbing across the page</p>	<ul data-bbox="818 454 1473 649" style="list-style-type: none"> <li>• Check the machine's environment. Conditions such as high humidity and high temperatures may cause this print quality problem.</li> <li>• Clean the drum unit.</li> <li>• If the problem is not solved after printing a few pages, replace the drum unit with a new drum unit.</li> </ul>
 <p data-bbox="196 976 754 1032">White Spots on black text and graphics at 94 mm intervals</p>  <p data-bbox="300 1279 651 1305">Black spots at 94 mm intervals</p>	<ul data-bbox="818 739 1473 974" style="list-style-type: none"> <li>• If the problem is not solved after printing a few pages, the drum unit may have foreign material, such as glue from a label, stuck on the drum. Clean the drum unit. <i>See Related Information: Clean the Drum Unit Using Drum Dot Print.</i></li> <li>• The drum unit may be damaged. Replace the drum unit with a new drum unit.</li> </ul>
 <p data-bbox="279 1568 673 1594">Black toner marks across the page</p>	<ul data-bbox="818 1332 1473 1854" style="list-style-type: none"> <li>• If you use label sheets for laser printers, the glue from the sheets may sometimes stick to the drum surface. Clean the drum unit. <i>See Related Information: Clean the Drum Unit Using Drum Dot Print.</i></li> <li>• If you used paper that has clips or staples, the drum unit may be damaged.</li> <li>• If the unpacked drum unit is in direct sunlight (or room light for long periods of time), the unit may be damaged.</li> <li>• Clean the drum unit.</li> <li>• The toner cartridge may be damaged. Replace the toner cartridge with a new toner cartridge.</li> <li>• The drum unit may be damaged. Replace the drum unit with a new drum unit.</li> </ul>
	<ul data-bbox="818 1877 1473 2112" style="list-style-type: none"> <li>• Clean the corona wire inside the drum unit by sliding the green tab. Make sure that the green tab on the drum unit is in the Home position.</li> <li>• The toner cartridge may be damaged. Replace the toner cartridge with a new toner cartridge.</li> <li>• The drum unit may be damaged.</li> </ul>

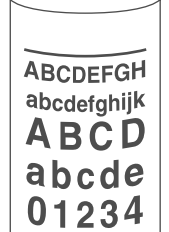
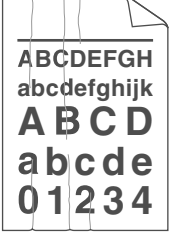
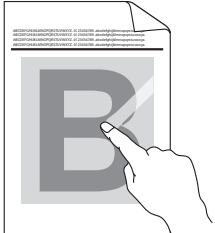

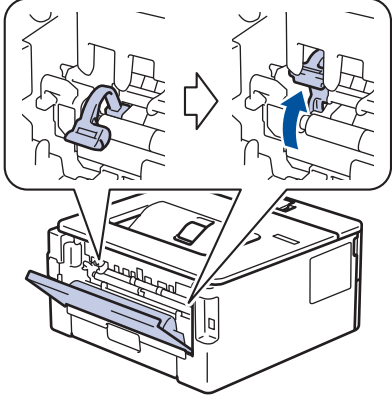
Examples of poor print quality	Recommendation
<p>Black lines down the page Printed pages have toner stains down the page</p>	<p>Replace the drum unit with a new drum unit.</p> <ul style="list-style-type: none"> <li>The fuser unit may be contaminated. Contact Brother customer service.</li> </ul>
 <p>White lines down the page</p>	<ul style="list-style-type: none"> <li>Make sure foreign material such as a torn piece of paper, sticky notes or dust is not inside the machine and around the toner cartridge and drum unit.</li> <li>The toner cartridge may be damaged. Replace the toner cartridge with a new toner cartridge.</li> <li>The drum unit may be damaged. Replace the drum unit with a new drum unit.</li> </ul>
 <p>Image skewed</p>	<ul style="list-style-type: none"> <li>Make sure the paper or other print media is loaded correctly in the paper tray and the guides are not too tight or too loose against the paper stack.</li> <li>Set the paper guides correctly.</li> <li>The paper tray may be too full.</li> <li>Check the paper type and quality.</li> <li>Check for loose objects such as torn paper inside the machine.</li> <li>If the problem only occurs during automatic 2-sided printing, check for torn paper in the 2-sided tray. Verify the 2-sided tray is inserted completely and the back cover is closed completely.</li> </ul>
 <p>Curled or wavy image</p>	<ul style="list-style-type: none"> <li>Check the paper type and quality. High temperatures and high humidity will cause paper to curl.</li> <li>If you do not use the machine often, the paper may have been in the paper tray too long. Turn over the stack of paper in the paper tray. Also, fan the paper stack, and then rotate the paper 180° in the paper tray.</li> <li>Open the back cover (face up output tray) to let the printed paper exit onto the face up output tray.</li> <li>Choose <b>Reduce Paper Curl</b> mode in the printer driver when you do not use our recommended print media.</li> </ul>
 <p>Wrinkles or creases</p>	<ul style="list-style-type: none"> <li>Make sure paper is loaded correctly.</li> <li>Check the paper type and quality.</li> <li>Turn over the stack of paper in the tray or rotate the paper 180° in the input tray.</li> </ul>
 <p>Poor fixing</p>	<ul style="list-style-type: none"> <li>Make sure the two green levers inside the back cover are in the up position. Pull up the two green levers until they stop.</li> </ul>

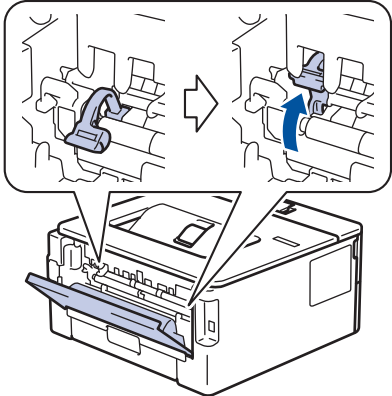
Examples of poor print quality	Recommendation
	 <ul style="list-style-type: none"> <li>• Make sure the media type setting in the printer driver matches the type of paper you are using.</li> <li>• Choose <b>Improve Toner Fixing</b> mode in the printer driver.</li> </ul> <p>If this selection does not provide enough improvement, change the printer driver setting in <b>Media Type</b> to a thick setting. If you are printing an envelope, choose <b>Env. Thick</b> in the media type setting.</p>
 <p>Envelope creases</p>	<ul style="list-style-type: none"> <li>• Make sure the two green levers inside the back cover are pulled down to the envelope position when you print envelopes. After you have finished printing, reset the levers back to their original position. Pull up the levers until they stop.</li> </ul>  <ul style="list-style-type: none"> <li>• Make sure envelopes are printed with the back cover (face up output tray) opened.</li> <li>• (For models with Manual Feed Slot) Make sure envelopes are fed only from the manual feed slot.</li> </ul>

### ✓ Related Information

- [Troubleshooting](#)
- [Test Print](#)
- [Clean the Drum Unit Using Drum Dot Print](#)
- [Reduce Toner Consumption](#)
- [Replace the Toner Cartridge](#)
- [Replace the Drum Unit](#)

## Network Problems

- [Error Messages](#)
- [Where Can I Find My Brother Machine's Network Settings?](#)
- [I Cannot Complete the Wireless Network Setup Configuration](#)
- [Use the Network Connection Repair Tool \(Windows®\)](#)
- [My Brother Machine Cannot Print over the Network](#)
- [I Want to Check that My Network Devices are Working Correctly](#)

## Error Messages

**Related Models:** HL-L2350DW/HL-L2357DW/HL-L2375DW

Your Brother machine will display an error message if an error occurs. The most common error messages are shown in the table.

Error Messages	Cause	Action
Connection Error	Other devices are trying to connect to the Wi-Fi Direct network at the same time.	Make sure there are no other devices trying to connect to the Wi-Fi Direct network, and then try to configure the Wi-Fi Direct settings again.
Connection Fail	The Brother machine and your mobile device cannot communicate during the Wi-Fi Direct network configuration.	<ul style="list-style-type: none"><li>• Move the mobile device closer to your Brother machine.</li><li>• Move your Brother machine and the mobile device to an obstruction-free area.</li><li>• If you are using the PIN Method of WPS, make sure you have entered the correct PIN.</li></ul>
No Device	When configuring the Wi-Fi Direct network, the Brother machine cannot find your mobile device.	<ul style="list-style-type: none"><li>• Make sure your machine and mobile device are in the Wi-Fi Direct mode.</li><li>• Move the mobile device closer to your Brother machine.</li><li>• Move your Brother machine and the mobile device to an obstruction-free area.</li><li>• If you are manually configuring the Wi-Fi Direct network, make sure you have entered the correct password.</li><li>• If your mobile device has a configuration page for how to obtain an IP address, make sure the IP address of your mobile device has been configured via DHCP.</li></ul>



### Related Information

- [Network Problems](#)

## Where Can I Find My Brother Machine's Network Settings?

- [Print the Network Configuration Report](#)
- [Change Machine Settings from Your Computer](#)

## I Cannot Complete the Wireless Network Setup Configuration

**Related Models:** HL-L2350DW/HL-L2357DW/HL-L2375DW

Turn your wireless router off and back on. Then try to configure the wireless settings again. If you are unable to resolve the problem, follow the instructions below:

Investigate the problem using the WLAN Report.

Cause	Action	Interface
Your security settings (SSID/ Network Key) are not correct.	<ul style="list-style-type: none"> <li>• Confirm the security settings using the Wireless Setup Helper utility. For more information and to download the utility, go to your model's <b>Downloads</b> page on the Brother Solutions Center at <a href="http://support.brother.com">support.brother.com</a>.</li> <li>• Select and confirm that you are using the correct security settings.                             <ul style="list-style-type: none"> <li>- See the instructions supplied with your wireless LAN access point/router for information on how to find the security settings.</li> <li>- The manufacturer's name or model number of the wireless LAN access point/router may be used as the default security settings.</li> <li>- Consult with the access point/router manufacturer, your Internet provider, or network administrator.</li> </ul> </li> </ul>	Wireless
Your Brother machine's MAC address is not allowed.	Confirm that the Brother machine's MAC Address is allowed in the filter. You can find the MAC Address on your Brother machine's control panel.	Wireless
Your wireless LAN access point/router is in stealth mode (not broadcasting the SSID).	<ul style="list-style-type: none"> <li>• Enter the correct SSID name or Network Key manually.</li> <li>• Check the SSID name or the Network Key in the instructions supplied with your wireless LAN access point/router and reconfigure the wireless network setup.</li> </ul>	Wireless
Your security settings (SSID/ password) are not correct.	<ul style="list-style-type: none"> <li>• Confirm the SSID and password.                             <ul style="list-style-type: none"> <li>- When you are configuring the network manually, the SSID and password are displayed on your Brother machine. If your mobile device supports the manual configuration, the SSID and password will be displayed on your mobile device's screen.</li> </ul> </li> </ul>	Wi-Fi Direct
You are using Android™ 4.0.	If your mobile device disconnects (approximately six minutes after using Wi-Fi Direct), try the one-push configuration using WPS (recommended) and set the Brother machine as a G/O.	Wi-Fi Direct
Your Brother machine is placed too far from your mobile device.	Move your Brother machine within about 3.3 feet (1 metre) of the mobile device when you configure the Wi-Fi Direct network settings.	Wi-Fi Direct
There are some obstructions (walls or furniture, for example) between your machine and the mobile device.	Move your Brother machine to an obstruction-free area.	Wi-Fi Direct
There is a wireless computer, Bluetooth®-supported device, microwave oven, or digital cordless phone near the Brother machine or the mobile device.	Move other devices away from the Brother machine or the mobile device.	Wi-Fi Direct

---

Cause	Action	Interface
If you have checked and tried all of the above, but still cannot complete the Wi-Fi Direct configuration, do the following:	<ul style="list-style-type: none"><li>• Turn your Brother machine off and back on. Then try to configure the Wi-Fi Direct settings again.</li><li>• If you are using your Brother machine as a client, confirm how many devices are allowed in the current Wi-Fi Direct network, and then check how many devices are connected.</li></ul>	Wi-Fi Direct

### For Windows®

If your wireless connection has been interrupted, and you have checked and tried all of the above, we recommend using the Network Connection Repair Tool.



### Related Information

- [Network Problems](#)
  - [Configure Your Machine for a Wireless Network When the SSID Is Not Broadcast](#)
  - [Use Wi-Fi Direct®](#)
-





## Use the Network Connection Repair Tool (Windows®)

**Related Models:** HL-L2350DW/HL-L2357DW/HL-L2370DN/HL-L2375DW

Use the Network Connection Repair Tool to fix the Brother machine's network settings. It will assign the correct IP address and Subnet Mask.

- Windows® 7/Windows® 8/Windows® 10  
You must log on with Administrator rights.
- Make sure the Brother machine is turned on and is connected to the same network as your computer.

1. Do one of the following:

Option	Description
Windows Server® 2008	Click  ( <b>Start</b> ) > <b>All Programs</b> > <b>Brother</b> > <b>Brother Utilities</b> . Click the drop-down list and select your model name (if not already selected). Click <b>Tools</b> in the left navigation bar, and then click <b>Network Connection Repair Tool</b> .
Windows® 7	Click  ( <b>Start</b> ) > <b>All Programs</b> > <b>Brother</b> > <b>Brother Utilities</b> . Click the drop-down list and select your model name (if not already selected). Click <b>Tools</b> in the left navigation bar, and then click <b>Network Connection Repair Tool</b> .
Windows® 8/ Windows® 10	Launch  ( <b>Brother Utilities</b> ), and then click the drop-down list and select your model name (if not already selected). Click <b>Tools</b> in the left navigation bar, and then click <b>Network Connection Repair Tool</b> .
Windows Server® 2012 / 2012 R2 / 2016	Launch  ( <b>Brother Utilities</b> ), and then click the drop-down list and select your model name (if not already selected). Click <b>Tools</b> in the left navigation bar, and then click <b>Network Connection Repair Tool</b> .



- If the **User Account Control** screen appears, click **Yes**.

2. Follow the on-screen instructions.
3. Check the diagnosis by printing the Network Configuration Report or the Printer Settings page.



The Network Connection Repair Tool will start automatically if you select the **Enable Connection Repair Tool** option in the Status Monitor. Right-click the Status Monitor screen, and then click **Other Settings** > **Enable Connection Repair Tool**. This is not recommended when your network administrator has set the IP address to Static, since it will automatically change the IP address.

If the correct IP address and the Subnet Mask are still not assigned even after using the Network Connection Repair Tool, ask your network administrator for this information.





### Related Information

- [Network Problems](#)
- [Print the Network Configuration Report](#)
- [My Brother Machine Cannot Print over the Network](#)
- [I Want to Check that My Network Devices are Working Correctly](#)



## My Brother Machine Cannot Print over the Network

**Related Models:** HL-L2350DW/HL-L2357DW/HL-L2370DN/HL-L2375DW

Cause	Action	Interface
Your security software blocks your machine's access to the network.	Some security software might block access without showing a security alert dialog box even after successful installation. To allow access, see the instructions for your security software or ask the software manufacturer.	Wired/Wireless
Your Brother machine was not assigned an available IP address.	<ul style="list-style-type: none"> <li>Confirm the IP address and the Subnet Mask. Verify that both the IP addresses and Subnet Masks of your computer and the Brother machine are correct and located on the same network. For more information about how to verify the IP address and the Subnet Mask, ask your network administrator.</li> <li>Windows® Confirm the IP address and the Subnet Mask using the Network Connection Repair Tool.</li> </ul>	Wired/Wireless
The failed print job is still in your computer's print queue.	<ul style="list-style-type: none"> <li>If the failed print job is still in your computer's print queue, delete it.</li> <li>Otherwise, double-click the printer icon in the following folder and cancel all documents:                             <ul style="list-style-type: none"> <li>Windows® 7 Click  (Start) &gt; <b>Devices and Printers &gt; Printers and Faxes.</b></li> <li>Windows® 8 Move your mouse to the lower right corner of your desktop. When the menu bar appears, click <b>Settings &gt; Control Panel.</b> In the <b>Hardware and Sound</b> group, click <b>View devices and printers &gt; Printers.</b></li> <li>Windows® 10 and Windows Server® 2016 Click  &gt; <b>Windows System &gt; Control Panel.</b> In the <b>Hardware and Sound</b> group, click <b>View devices and printers &gt; Printers.</b></li> <li>Windows Server® 2008 Click <b>Start &gt; Control Panel &gt; Printers.</b></li> <li>Windows Server® 2012 Move your mouse to the lower right corner of your desktop. When the menu bar appears, click <b>Settings &gt; Control Panel.</b> In the <b>Hardware</b> group, click <b>View devices and printers &gt; Printers.</b></li> <li>Windows Server® 2012 R2 Click <b>Control Panel</b> on the <b>Start</b> screen. In the <b>Hardware</b> group, click <b>View devices and printers.</b></li> <li>macOS v10.10.5, v10.11.x, v10.12.x Click <b>System Preferences &gt; Printers &amp; Scanners.</b></li> </ul> </li> </ul>	Wired/Wireless
Your Brother machine is not connected to the wireless network.	Print the WLAN Report to check the error code on the printed report.	Wireless

If you have checked and tried all of the above, but your Brother machine still cannot print, uninstall the printer driver and reinstall it.



---

## Related Information

---

- [Network Problems](#)
  - [Print the WLAN Report](#)
  - [Wireless LAN Report Error Codes](#)
  - [Use the Network Connection Repair Tool \(Windows®\)](#)
  - [I Want to Check that My Network Devices are Working Correctly](#)
-

## I Want to Check that My Network Devices are Working Correctly

**Related Models:** HL-L2350DW/HL-L2357DW/HL-L2370DN/HL-L2375DW

Check	Action	Interface
Check that your Brother machine, access point/router, or network hub is turned on.	<p><b>Check the following:</b></p> <ul style="list-style-type: none"> <li>The power cord is connected correctly and the Brother machine is turned on.</li> <li>The access point/router or hub is turned on and its link button is blinking.</li> <li>All protective packaging has been removed from the machine.</li> <li>The toner cartridge and drum unit are installed correctly.</li> <li>The front and back covers are fully closed.</li> <li>Paper is inserted correctly in the paper tray.</li> <li>(For wired networks) A network cable is securely connected to the Brother machine and to the router or hub.</li> </ul>	Wired/Wireless
Check the <b>Link Status</b> in the Network Configuration Report or the Printer Settings page.	Print the Network Configuration Report and check that <b>Ethernet Link Status</b> or <b>Wireless Link Status</b> is <b>Link OK</b> .	Wired/Wireless
Check that you can "ping" the Brother machine from your computer.	<p>Ping the Brother machine from your computer using the IP address or the node name in the Windows® command prompt or Mac Terminal application:</p> <p>ping &lt;ipaddress&gt; or &lt;nodename&gt;.</p> <ul style="list-style-type: none"> <li>Successful: Your Brother machine is working correctly and connected to the same network as your computer.</li> <li>Unsuccessful: Your Brother machine is not connected to the same network as your computer.</li> </ul> <p>(Windows®) Ask the network administrator and use the Network Connection Repair Tool to fix the IP address and the subnet mask.</p> <p>(Mac) Confirm that the IP address and the Subnet Mask are set correctly.</p>	Wired/Wireless
Check that your Brother machine is connected to the wireless network.	Print the WLAN Report to check the error code on the printed report.	Wireless

If you have checked and tried all of the above but you are still having problems, see the instructions supplied with your wireless LAN access point/router to find the SSID and the Network Key information and set them correctly.



### Related Information

- [Network Problems](#)
- [Print the Network Configuration Report](#)
- [Print the WLAN Report](#)
- [Wireless LAN Report Error Codes](#)
- [Use the Network Connection Repair Tool \(Windows®\)](#)
- [My Brother Machine Cannot Print over the Network](#)

## Google Cloud Print Problems

**Related Models:** HL-L2350DW/HL-L2357DW/HL-L2370DN/HL-L2375DW

Difficulty	Suggestions
My Brother machine is not displayed in the printer list.	Make sure your machine is turned on.
	Confirm that Google Cloud Print™ is enabled.
	Confirm that your machine is registered with Google Cloud Print™. If it is not registered, try to register again.
I cannot print.	Make sure your machine is turned on.
	Confirm your network settings. See <i>Related Information</i> .
	Certain files may not be printable, or may not appear exactly as they are displayed.
I cannot register my Brother machine with Google Cloud Print™.	Make sure your machine is connected to a network with Internet access.
	Verify that the date and time are set correctly on your machine.
I do not see a confirmation message on my Brother machine when I try to register with Google Cloud Print™, even after repeating the registration steps.	Make sure your Brother machine is idle while you are registering with Google Cloud Print™.



### Related Information

- [Troubleshooting](#)
- [Network Settings for Using Google Cloud Print](#)

## AirPrint Problems

Difficulty	Suggestions
My Brother machine is not displayed in the printer list.	Make sure your Brother machine is turned on.
	Confirm the network settings. See <i>Related Information</i> .
	Move the mobile device closer to the wireless access point/router, or to your Brother machine.
I cannot print.	Make sure your Brother machine is turned on.
	Confirm the network settings. See <i>Related Information</i> .
I am trying to print a multiple-page document from an iOS device, but ONLY the first page is printing.	Make sure you are running the latest OS version. Refer to the following Apple support article for more information about AirPrint: <a href="https://support.apple.com/kb/HT4356">support.apple.com/kb/HT4356</a> .



### Related Information

- [Troubleshooting](#)
- [AirPrint Overview](#)

## Other Problems

Difficulties	Suggestions
The machine will not turn on.	<p>Adverse conditions on the power connection (such as lightning or a power surge) may have triggered the machine's internal safety mechanisms. Unplug the power cord. Wait for ten minutes, then plug in the power cord and press  to turn on the machine.</p> <p>If the problem is not solved and you are using a power breaker, disconnect it to make sure it is not the problem. Plug the machine's power cord directly into a different known working wall electrical socket. If there is still no power, try a different power cable.</p>
The Brother software cannot be installed.	<p><b>(Windows®)</b></p> <p>If the Security Software warning appears on the computer screen during the installation, change the Security Software settings to permit the Brother product setup program or other program to run.</p> <p><b>(Mac)</b></p> <p>If you are using a firewall function of anti-spyware or antivirus security software, temporarily disable it and then install the Brother software.</p>



### Related Information

- [Troubleshooting](#)

## Machine Information

- [Check the Serial Number](#)
- [Check the Firmware Version](#)
- [Reset Functions Overview](#)
- [Reset Your Brother Machine](#)

## Check the Serial Number

**Related Models:** HL-L2350DW/HL-L2357DW/HL-L2370DN/HL-L2375DW

1. Press ▲ or ▼ to select the [Machine Info.] option, and then press **OK**.
2. Press ▲ or ▼ to select the [Serial No.] option, and then press **OK**.

The machine displays the serial number on the LCD.



### Related Information

- [Machine Information](#)



## Check the Firmware Version

**Related Models:** HL-L2350DW/HL-L2357DW/HL-L2370DN/HL-L2375DW

1. Press ▲ or ▼ to display the [Machine Info.] option, and then press **OK**.
2. Press ▲ or ▼ to display the [Firmware Version] option, and then press **OK**.

The machine displays the firmware version on the LCD.



### Related Information

- [Machine Information](#)

## Reset Functions Overview

**Related Models:** HL-L2350DW/HL-L2357DW/HL-L2370DN/HL-L2375DW

The following reset functions are available:



Unplug the interface cable before you choose Network Settings Reset function or Factory Reset function.



Subdivided reset functions are not available for some models.

### 1. Machine Reset

This function resets the following settings:

- Setting Lock
- Language Setting

### 2. Network Settings Reset (For Network Models)

Reset the print server back to its default factory settings (includes Password and IP Address information).

### 3. Factory Reset

Brother strongly recommends you perform this operation when you dispose of the machine.



## Related Information

- [Machine Information](#)

## Reset Your Brother Machine

**Related Models:** HL-L2350DW/HL-L2357DW/HL-L2370DN/HL-L2375DW

1. Press **▲** or **▼** to display the [Initial Setup] option, and then press **OK**.
2. Press **▲** or **▼** to display the [Reset] option, and then press **OK**.
3. Press **▲** or **▼** to choose the type of reset you want to perform, and then press **OK**.
4. Press **▼**.
5. Press **▼** for [Yes].

The machine will restart.



### Related Information

- [Machine Information](#)

## **Routine Maintenance**

- [Replace Supplies](#)
- [Clean the Machine](#)
- [Check the Remaining Part Life](#)
- [Pack and Ship Your Brother Machine](#)

## Replace Supplies

You must replace supplies when the machine indicates that the life of the supply is over.

Using non-Brother supplies may affect the print quality, hardware performance, and machine reliability. The toner cartridge and drum unit are two separate supplies. Make sure both are installed as an assembly. The model name of supplies may vary depending on the country.

### NOTE

- Be sure to seal up the used supplies tightly in a bag so that toner powder does not spill out of the cartridge.
- Visit [www.brother.com/original/index.html](http://www.brother.com/original/index.html) for instructions on how to return your used supplies to the Brother collection and recycling program. If you choose not to return your used supply, discard the used supply according to local regulations, keeping it separate from domestic waste. If you have questions, contact your local waste disposal office.
- We recommend placing used and new supplies on a piece of paper to prevent accidentally spilling or scattering the material inside.
- If you use paper that is not a direct equivalent for the recommended print media, the life of supplies and machine parts may be reduced.
- The projected life for each of the toner cartridges is based on ISO/IEC 19752. Frequency of replacement will vary depending on the print volume, percentage of coverage, types of media used, and powering on/off the machine.
- Frequency of replacing supplies except toner cartridges will vary depending on the print volume, types of media used, and powering on/off the machine.
- Handle the toner cartridge carefully. If toner scatters on your hands or clothes, immediately wipe or wash it off with cold water.

### IMPORTANT

- To avoid print quality problems, DO NOT touch the shaded parts shown in the illustrations.

#### Toner cartridge

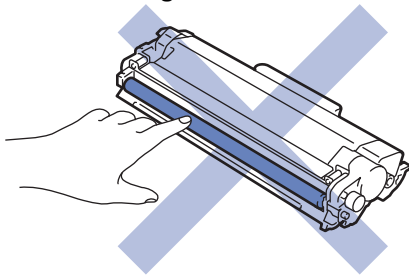

#### Drum unit

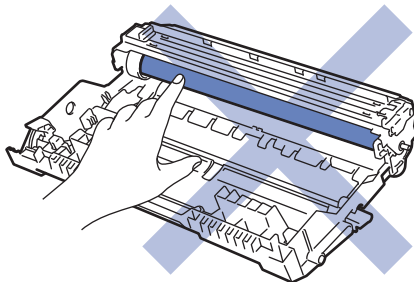

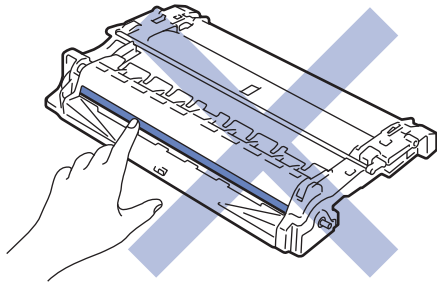

---

### Related Information

- [Routine Maintenance](#)
  - [Replace the Toner Cartridge](#)
  - [Replace the Drum Unit](#)
  - [Error and Maintenance Indications](#)
  - [Error and Maintenance Messages](#)
  - [Supplies](#)
-

## Replace the Toner Cartridge

1. Make sure the machine is turned on.
2. Open the front cover.

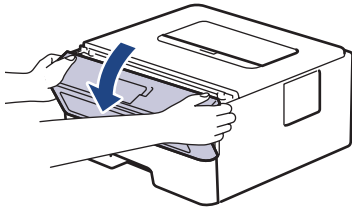

3. Remove the toner cartridge and drum unit assembly from the machine.

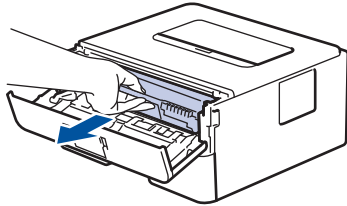

4. Push down the green lock lever and take the toner cartridge out of the drum unit.

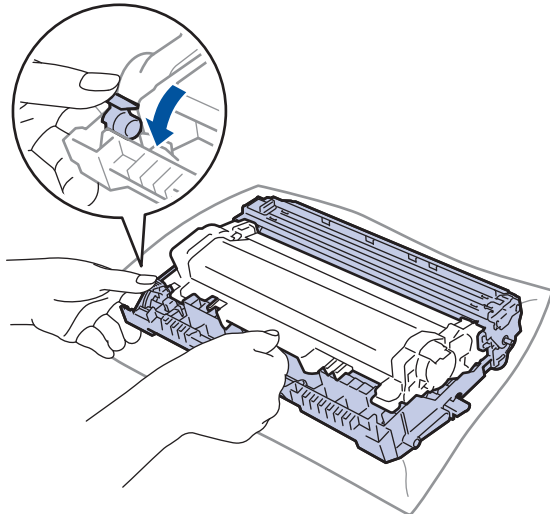

5. Unpack the new toner cartridge.
6. Remove the protective cover.

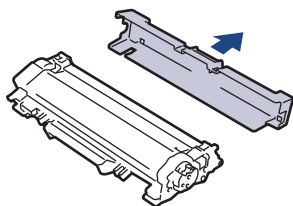

7. Push the new toner cartridge firmly into the drum unit until you hear it lock into place.

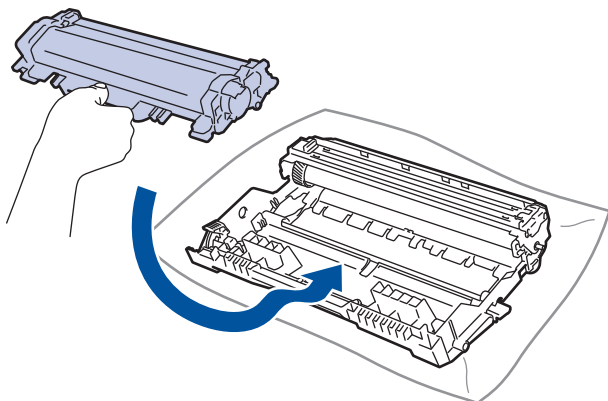



Make sure you put the toner cartridge in correctly or it may separate from the drum unit.

- Clean the corona wire inside the drum unit by gently sliding the green tab from left to right and right to left several times.

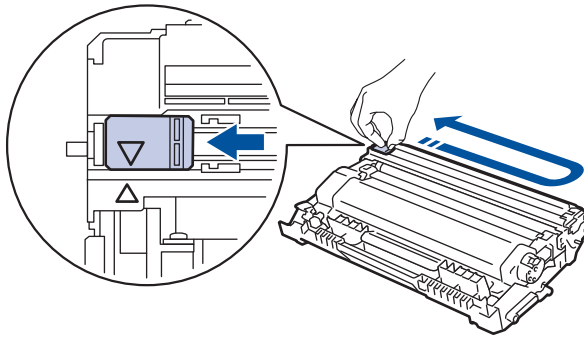

Be sure to return the tab to the Home position (▲). The arrow on the tab must be aligned with the arrow on the drum unit. If it is not, printed pages may have a vertical stripe.

- Install the toner cartridge and drum unit assembly back into the machine.

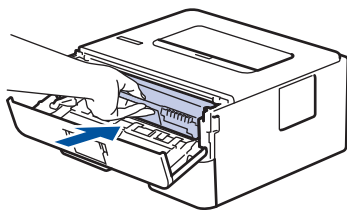

- Close the front cover of the machine.



- Do not turn off the machine or open the front cover until the machine returns to Ready Mode.
- The toner cartridge that comes with your Brother machine is a Inbox toner cartridge.
- It is a good idea to keep a new toner cartridge ready for use when you see the Toner Low warning.
- To ensure high quality printing, we recommend using only Brother Original toner cartridges. When you want to buy toner cartridges, contact Brother Dealer.
- DO NOT unpack the new toner cartridge until you are ready to install it.
- If a toner cartridge is left unpacked for a long time, the toner life will be shortened.
- Brother strongly recommends you DO NOT refill the toner cartridge provided with your machine. We also strongly recommend you continue to use only Brother Original replacement toner cartridges. Use or attempted use of third party toner and/or cartridges in the Brother machine may cause damage to the machine and/or may result in unsatisfactory print quality. Our limited warranty coverage does not apply to any problem that is caused by the use of third party toner and/or cartridges. To protect your investment and obtain premium performance from the Brother machine, we strongly recommend the use of Brother Original Supplies.



## Related Information

- [Replace Supplies](#)
- [Improve the Print Quality](#)



## Replace the Drum Unit

1. Make sure the machine is turned on.
2. Open the front cover.

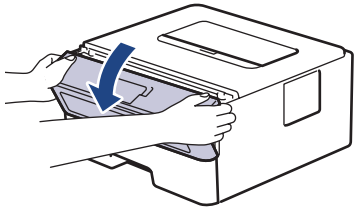

3. Remove the toner cartridge and drum unit assembly from the machine.

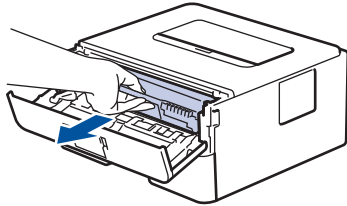

4. Push down the green lock lever and take the toner cartridge out of the drum unit.

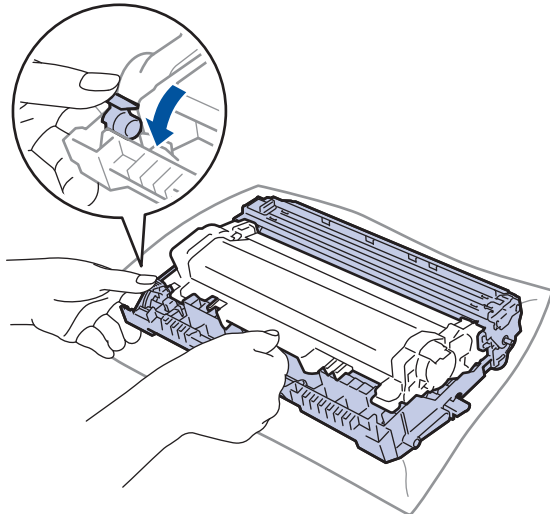

5. Unpack the new drum unit.
6. Push the toner cartridge firmly into the new drum unit until you hear it lock into place.

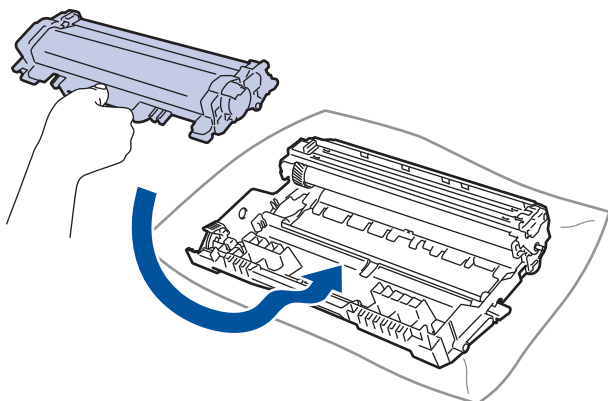

Make sure you put the toner cartridge in correctly or it may separate from the drum unit.

7. Install the toner cartridge and drum unit assembly back into the machine.

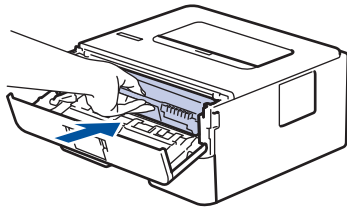

8. Close the front cover of the machine.

## NOTE

- Drum wear and tear occurs due to use and rotation of the drum and interaction with paper, toner and other materials in the paper path. In designing this product, Brother decided to use the number of rotations of the drum as a reasonable determinant of the drum life. When a drum reaches the factory-established rotation limit corresponding to the rated page yield, the product's LCD will advise you to replace the drum. The product will continue to function; however, print quality may not be optimal.
- If an unpacked drum unit is placed in direct sunlight (or room light for long periods of time), the unit may be damaged.
- There are many factors that determine the actual drum life, such as the temperature, humidity, type of paper, type of toner used and so on. Under ideal conditions, the average drum life is estimated at approximately 12,000 pages (based on 1 page per job [A4/Letter single-sided pages]). The number of pages may be affected due to a variety of factors including but not limited to media type and media size. Because we have no control over the many factors that determine the actual drum life, we cannot guarantee a minimum number of pages that will be printed by your drum.
- For best performance, use only Brother Original toner.
- The machine should be used only in a clean, dust-free environment with adequate ventilation.
- Printing with a non-Brother drum unit may reduce not only the print quality but also the quality and life of the machine itself. Warranty coverage does not apply to problems caused by the use of a non-Brother drum unit.



### Related Information

- [Replace Supplies](#)
- [Error and Maintenance Indications](#)
- [Error and Maintenance Messages](#)
- [Improve the Print Quality](#)

## Clean the Machine

Clean the outside and inside of the machine regularly with a dry, lint-free cloth.

When you replace the toner cartridge or the drum unit, make sure you clean the inside of the machine. If printed pages are stained with toner, clean the inside of the machine with a dry, lint-free cloth.

### WARNING

- DO NOT use flammable substances, any type of spray, or an organic solvent/liquid containing alcohol or ammonia to clean the inside or outside of the product. Doing so could cause a fire. Instead, use only a dry, lint-free cloth.



### IMPORTANT

- DO NOT use isopropyl alcohol to remove dirt from the control panel. It may crack the panel.
- To avoid print quality problems, DO NOT touch the shaded parts shown in the illustrations.

#### Toner cartridge

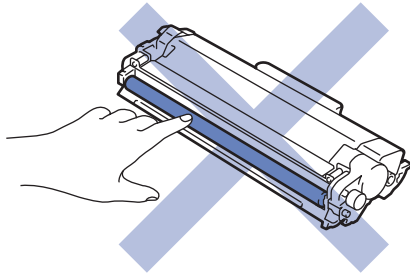

#### Drum unit

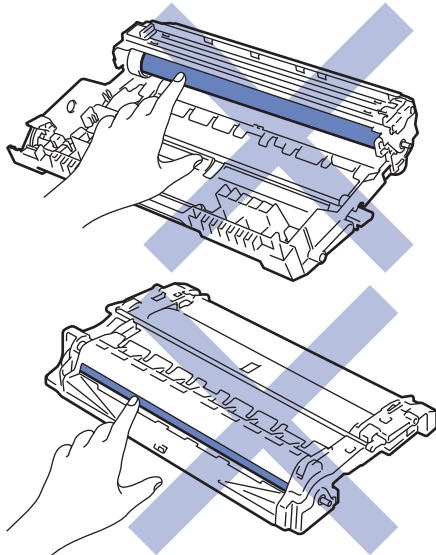

### Related Information

- [Routine Maintenance](#)
- [Clean the Corona Wire](#)
- [Clean the Drum Unit Using Drum Dot Print](#)

- 
- Clean the Paper Pick-up Rollers
-

## Clean the Corona Wire

If you have print quality problems or the control panel displays [Drum !] status, clean the corona wire.

1. Open the front cover.

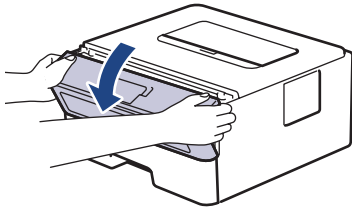

2. Remove the toner cartridge and drum unit assembly from the machine.

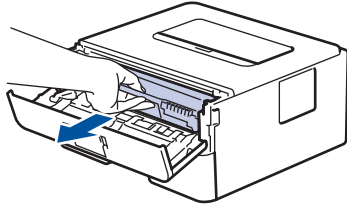

3. Clean the corona wire inside the drum unit by gently sliding the green tab from left to right and right to left several times.

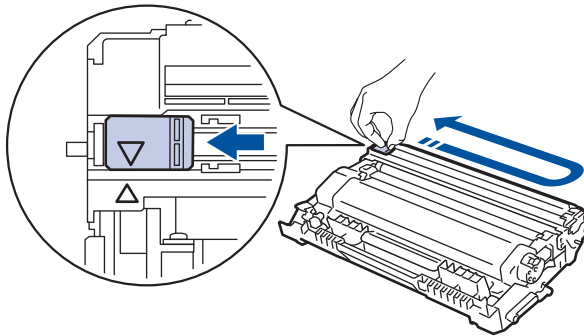

Be sure to return the tab to the Home position (▲). The arrow on the tab must be aligned with the arrow on the drum unit. If it is not, printed pages may have a vertical stripe.

4. Install the toner cartridge and drum unit assembly back into the machine.

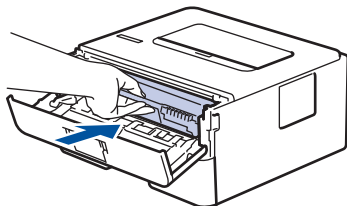

5. Close the front cover of the machine.



### Related Information

- [Clean the Machine](#)
- [Error and Maintenance Indications](#)
- [Error and Maintenance Messages](#)

## Clean the Drum Unit Using Drum Dot Print

If your printout has dots or other repeating marks at 94 mm intervals, the drum may have foreign material, such as glue from a label, stuck on the drum surface.

>> [HL-L2310D](#)

>> [HL-L2350DW/HL-L2357DW/HL-L2370DN/HL-L2375DW](#)

### HL-L2310D

1. Make sure the machine is in Ready mode.
2. Press **Go** eight times.  
The machine prints the Drum Dot Check Sheet.
3. Press and hold  to turn the machine off.
4. Open the front cover.

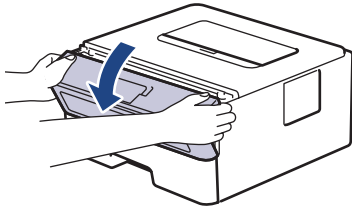

5. Remove the toner cartridge and drum unit assembly from the machine.

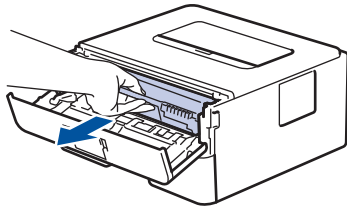

6. Push down the green lock lever and take the toner cartridge out of the drum unit.

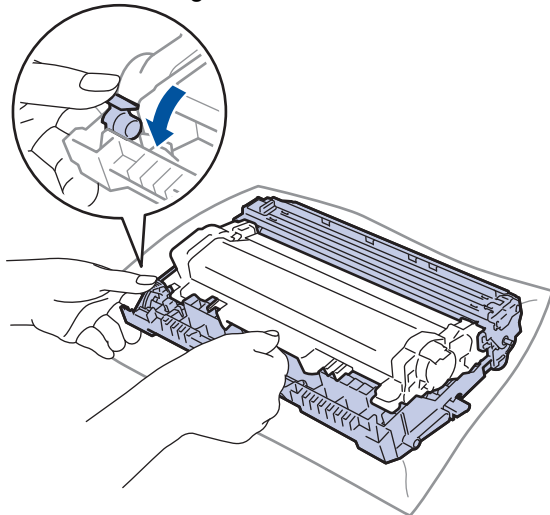

7. Turn the drum unit as shown in the illustration. Make sure that the drum unit gear is on the left side.

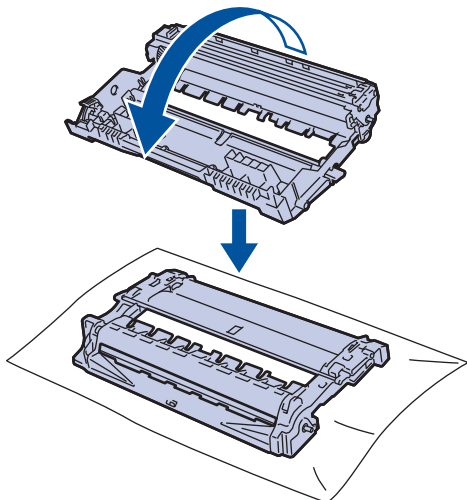

8. Use the numbered markers next to the drum roller to find the mark on the drum. For example, a dot in column 2 on the check sheet means that there is a mark in drum region “2”.

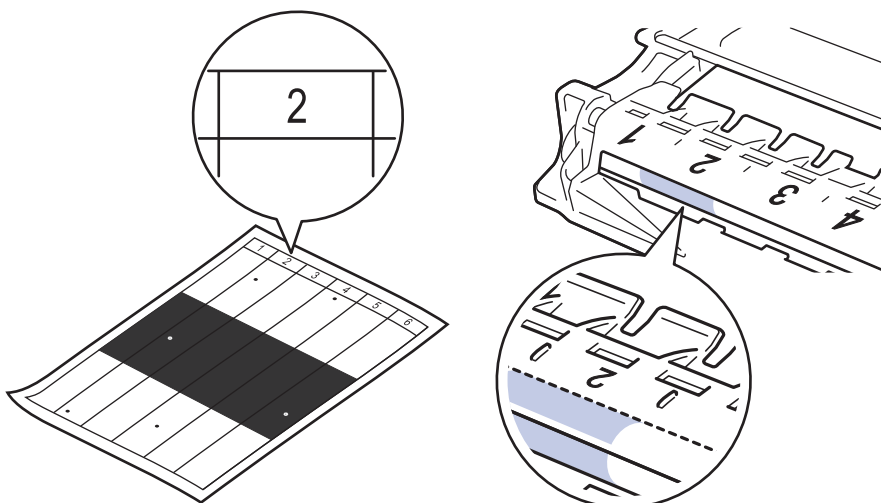

9. Turn the edge of the drum unit towards you while looking at the drum surface to find the mark.

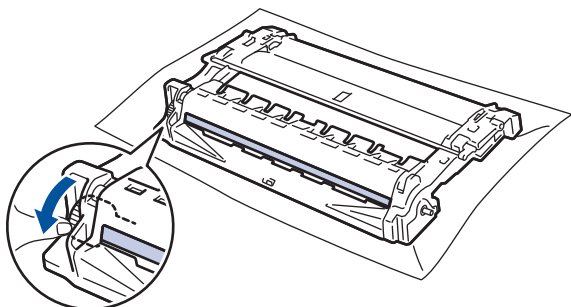

## IMPORTANT

- To avoid print quality problems, DO NOT touch the surface of the drum unit, only the wheel on the end.

10. Wipe the surface of the drum gently with a dry cotton swab until the mark or foreign material on the surface comes off.

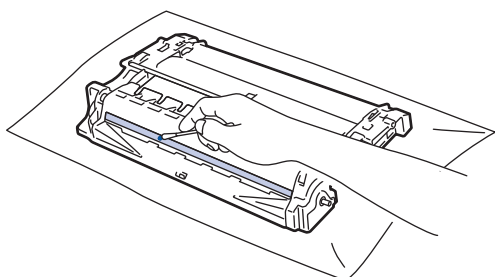

## NOTE

DO NOT clean the surface of the photosensitive drum with a sharp object or any liquids.

11. Push the toner cartridge firmly into the drum unit until you hear it lock into place.

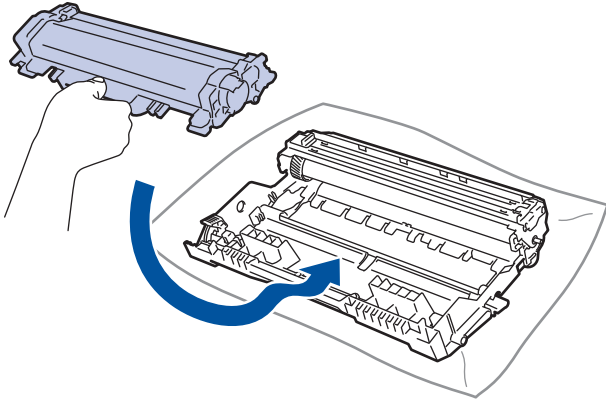

Make sure you put the toner cartridge in correctly or it may separate from the drum unit.

12. Install the toner cartridge and drum unit assembly back into the machine.

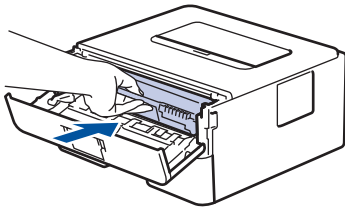

13. Close the front cover of the machine.

14. Press  to turn the machine on.

## HL-L2350DW/HL-L2357DW/HL-L2370DN/HL-L2375DW

1. Make sure the machine is in Ready mode.
2. Press **▲** or **▼** to display the [Print Reports] option, and then press **OK**.
3. Press **▲** or **▼** to select the [Drum Dot Print] option.
4. Press **Go**.  
The machine prints the Drum Dot Check Sheet.
5. Press and hold  to turn the machine off.
6. Open the front cover.

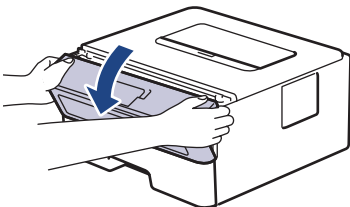

7. Remove the toner cartridge and drum unit assembly from the machine.

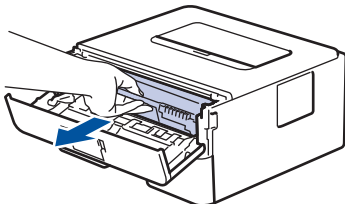

8. Push down the green lock lever and take the toner cartridge out of the drum unit.



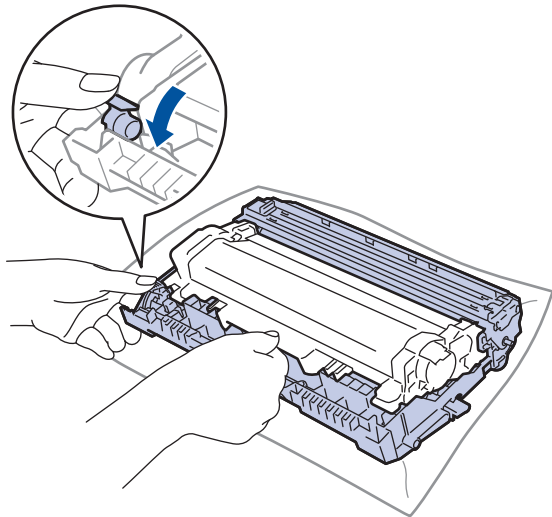

9. Turn the drum unit as shown in the illustration. Make sure that the drum unit gear is on the left side.

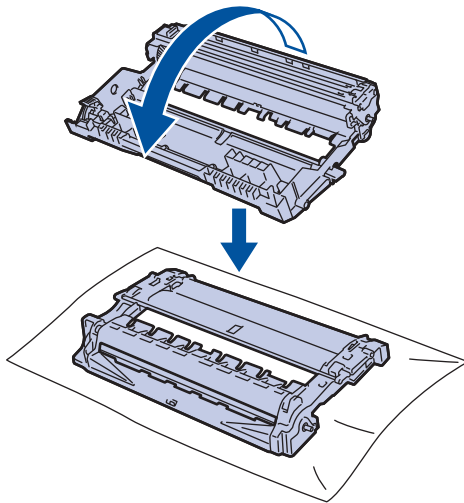

10. Use the numbered markers next to the drum roller to find the mark on the drum. For example, a dot in column 2 on the check sheet means that there is a mark in drum region "2".

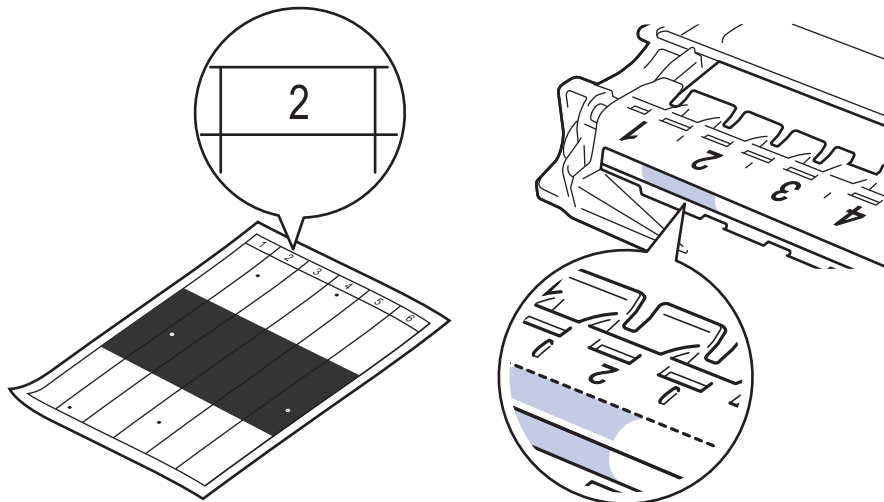

11. Turn the edge of the drum unit towards you while looking at the drum surface to find the mark.

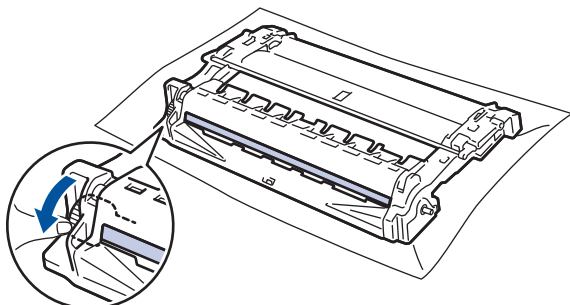

## IMPORTANT

- To avoid print quality problems, DO NOT touch the surface of the drum unit, only the wheel on the end.

12. Wipe the surface of the drum gently with a dry cotton swab until the mark or foreign material on the surface comes off.

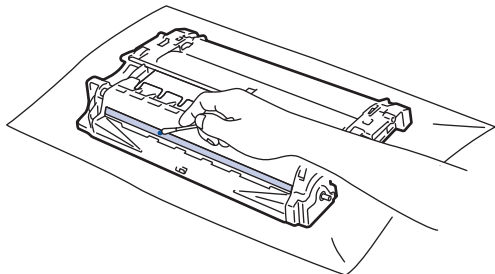

## NOTE

DO NOT clean the surface of the photosensitive drum with a sharp object or any liquids.

13. Push the toner cartridge firmly into the drum unit until you hear it lock into place.

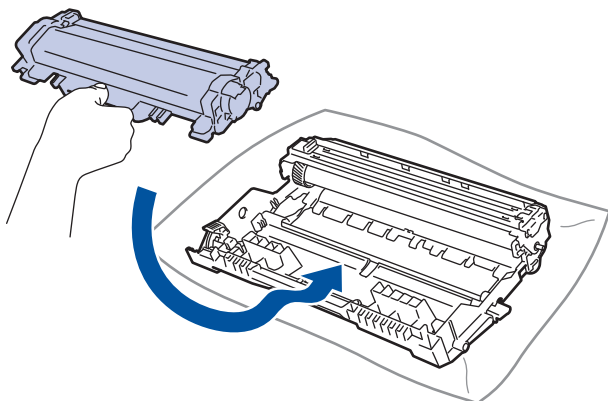

Make sure you put the toner cartridge in correctly or it may separate from the drum unit.

14. Install the toner cartridge and drum unit assembly back into the machine.

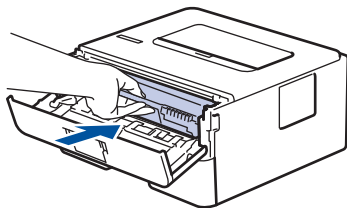

15. Close the front cover of the machine.

16. Press  to turn the machine on.



## Related Information

- [Clean the Machine](#)
- [Improve the Print Quality](#)

## Clean the Paper Pick-up Rollers

Cleaning the paper pick-up rollers periodically may prevent paper jams by ensuring that paper feeds properly.

If you have paper feed problems, clean the pick-up rollers as follows:

1. Press and hold  to turn the machine off.
2. Pull the paper tray completely out of the machine.

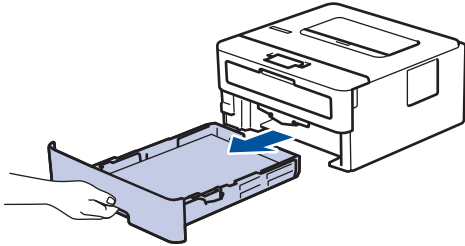

3. If paper is loaded or something is stuck inside in the paper tray, remove it.
4. Tightly wring out a lint-free cloth soaked in lukewarm water, and then wipe the separator pad on the paper tray to remove dust.

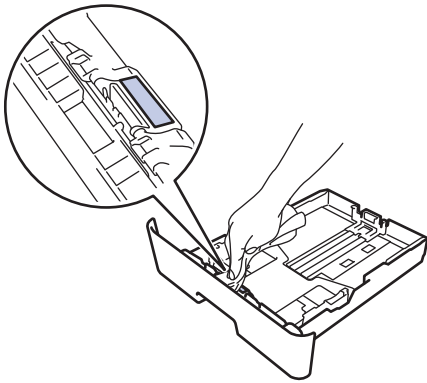

5. Wipe the two pick-up rollers inside the machine to remove dust.

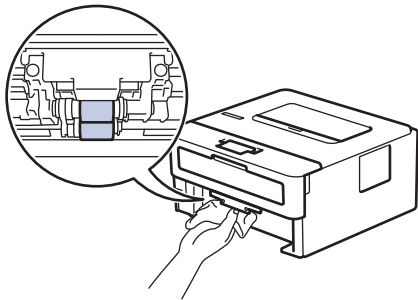

6. Reload the paper and put the paper tray firmly back in the machine.
7. Press  to turn the machine on.

### Related Information

- [Clean the Machine](#)
- [Printing Problems](#)

## Check the Remaining Part Life

**Related Models:** HL-L2350DW/HL-L2357DW/HL-L2370DN/HL-L2375DW

1. Press ▲ or ▼ to display the [Machine Info.] option, and then press **OK**.
2. Press ▲ or ▼ to select the [Parts Life] option, and then press **OK**.
3. Press ▲ or ▼ to select the machine part you want to check, and then press **OK**.  
The LCD displays the approximate remaining part life.



### Related Information

- [Routine Maintenance](#)
-

## Pack and Ship Your Brother Machine



- If for any reason you must ship your machine, carefully repack the machine in the original packaging to avoid any damage during transit. The machine should be adequately insured with the carrier.

1. Press and hold  to turn the machine off. Leave the machine off for at least 10 minutes to cool down.
2. Disconnect all the cables, and then unplug the power cord from the electrical socket.



Some models are equipped with a non-detachable AC power cord. If your cord is not detachable, fold it loosely and rest it on top of the machine so it packs easily.

3. Put the machine into the bag it originally came in.
4. Pack the machine, the printed materials, and the AC power cord (if applicable) in the original carton with the original packing material as shown. The illustrations may differ from the actual packing materials. The materials vary depending on your model.

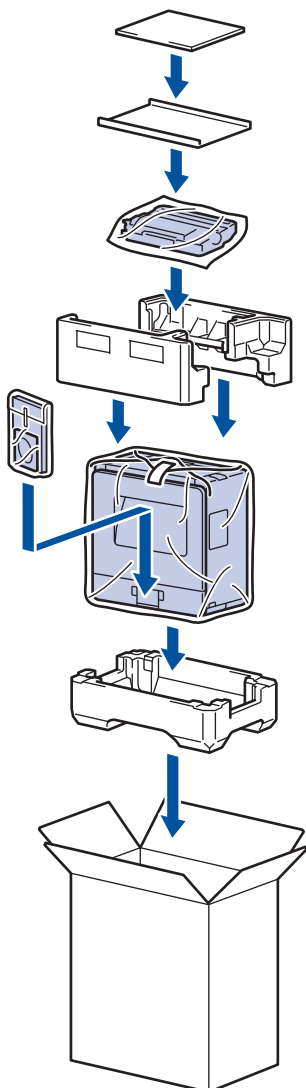

5. Close the carton and tape it shut.



### Related Information

- [Routine Maintenance](#)

## Machine Settings

Customise settings and features, create shortcuts, and work with options displayed on the machine's LCD to make your Brother machine a more efficient work tool.

- [Change Machine Settings from the Control Panel](#)
- [How to Install the Remote Printer Console Software \(Windows® only\)](#)
- [Change Machine Settings from Your Computer](#)

## Change Machine Settings from the Control Panel

- [General Settings](#)
- [Menu Table \(for LCD Models\)](#)

## General Settings

- [Set Sleep Mode Countdown](#)
- [About Deep Sleep Mode](#)
- [Set Auto Power Off Mode](#)
- [Reduce Toner Consumption](#)
- [Reduce Printing Noise](#)
- [Change the Language on the LCD](#)



## Set Sleep Mode Countdown

The Sleep Mode (or Power Save Mode) setting can reduce power consumption. Select how long the machine must be idle before it goes into Sleep Mode. The Sleep Mode timer is reset when the machine receives a print job.

When the machine is in Sleep Mode, it acts as if it is turned off. The machine will wake up and start printing when it receives a print job. Use these instructions to set a time delay (countdown) before the machine enters Sleep Mode.

1. Press ▲ or ▼ to select the [General Setup] option, and then press **OK**.
2. Press ▲ or ▼ to select the [Ecology] option, and then press **OK**.
3. Press ▲ or ▼ to select the [Sleep Time] option, and then press **OK**.
4. Press ▲ or ▼ to enter the length of time, in minutes, that the machine should remain idle before entering Sleep Mode.  
Press **Go**.



### Related Information

- [General Settings](#)

## About Deep Sleep Mode

If the machine is in Sleep mode and does not receive any jobs for certain length of time, the machine will automatically enter Deep Sleep mode. The length of time is based on your specific model and settings.

Deep Sleep mode uses less power than Sleep mode.

Applicable Models	Machine's Control Panel in Deep Sleep Mode	Conditions That Will Wake the Machine
HL-L2310D	 The <b>Ready</b> LED is dimmed.	<ul style="list-style-type: none"><li>• The machine receives a job.</li><li>• Someone presses a button on the control panel.</li></ul>
HL-L2350DW/HL-L2357DW/ HL-L2370DN/HL-L2375DW	The LCD displays <i>Deep Sleep</i> .	<ul style="list-style-type: none"><li>• The machine receives a job.</li><li>• Someone presses a button on the control panel.</li></ul>



### Related Information

- [General Settings](#)

## Set Auto Power Off Mode

If the machine is in Deep Sleep Mode for certain length of time, based on your model and settings, the machine will go into Power Off Mode automatically. The machine does not go into Power Off Mode when the machine is connected to a network.

- To start printing, press  on the control panel and then send a print job.

>> [HL-L2310D](#)

>> [HL-L2350DW/HL-L2357DW/HL-L2370DN/HL-L2375DW](#)

### HL-L2310D

1. Make sure that the front cover is closed and the power cord is plugged in.
2. Press  to turn on the machine and make sure only the **Ready** LED lights up.
3. Press **Go** four times to turn the function On or Off.  
All LEDs blink twice when Auto Power Off Mode is turned on.  
All LEDs blink once when Auto Power Off Mode is turned off.

### HL-L2350DW/HL-L2357DW/HL-L2370DN/HL-L2375DW



Select how long the machine must be in Deep Sleep Mode before it goes into Auto Power Off Mode.

1. Press **▲** or **▼** to display the [General Setup] option, and then press **OK**.
2. Press **▲** or **▼** to display the [Ecology] option, and then press **OK**.
3. Press **▲** or **▼** to select the [Auto Power Off] option, and then press **OK**.
4. Press **▲** or **▼** to select the option you want, and then press **Go**.



### Related Information

- [General Settings](#)

## Reduce Toner Consumption

Using the Toner Save feature may reduce toner consumption. When Toner Save is set to on, the print on your documents appears lighter.

We DO NOT recommend using the Toner Save feature for printing photo or greyscale images.

1. Press ▲ or ▼ to display the [General Setup] option, and then press **OK**.
2. Press ▲ or ▼ to display the [Ecology] option, and then press **OK**.
3. Press ▲ or ▼ to display the [Toner Save] option, and then press **OK**.
4. Press ▲ or ▼ to display [On], and then press **Go**.

### ✓ Related Information

- [General Settings](#)
- [Improve the Print Quality](#)



## Reduce Printing Noise

The Quiet Mode setting can reduce printing noise. When Quiet Mode is turned on, the print speed becomes slower. The factory setting is off.

>> [HL-L2310D](#)

>> [HL-L2350DW/HL-L2357DW/HL-L2370DN/HL-L2375DW](#)

### HL-L2310D

1. Press and hold  to turn the machine off.
2. Make sure that the front cover is closed and the power cord is plugged in.
3. Hold down **Go** as you press  to turn on the machine. Keep **Go** pressed down until the **Toner**, **Drum**, and **Paper** LEDs light up.
4. Press **Go** 11 times to turn the function On or Off.  
All LEDs blink twice when you turn on the Quiet Mode.  
All LEDs blink once when you turn off the Quiet Mode.

### HL-L2350DW/HL-L2357DW/HL-L2370DN/HL-L2375DW

1. Press **▲** or **▼** to display the [General Setup] option, and then press **OK**.
2. Press **▲** or **▼** to display the [Ecology] option, and then press **OK**.
3. Press **▲** or **▼** to select the [Quiet Mode] option, and then press **OK**.
4. Press **▲** or **▼** to display the [On] or [Off] option, and then press **Go**.



### Related Information

- [General Settings](#)

## Change the Language on the LCD

Change the LCD language if needed.

This feature is not available in some countries.

1. Press ▲ or ▼ to display the [Initial Setup] option, and then press **OK**.
2. Press ▲ or ▼ to display the [Local Language] option, and then press **OK**.
3. Press ▲ or ▼ to display your language, and then press **Go**.



### Related Information

- [General Settings](#)
-

## Menu Table (for LCD Models)

- [Settings Tables \(1 Line LCD models\)](#)

## Settings Tables (1 Line LCD models)

**Related Models:** HL-L2350DW/HL-L2357DW/HL-L2370DN/HL-L2375DW

Use these tables to understand the various menus and options that you will use to set your preferences on the machine.

### [General Setup]

Level 1	Level 2	Level 3	Description
Tray Setting	Paper Type	-	Set the type of paper in the paper tray.
	Paper Size	-	Set the size of paper.
	Check Size	-	Select whether to display a message telling you to check that the size of the paper in the machine and the machine's Paper Size setting match.
	Manual Feed	-	Select whether to print from the Manual Feed Slot.
Resolution	-	-	Choose a print resolution.
Density	-	-	Increase or decrease the print density.
Ecology	Eco Mode	-	Turn the following machine settings on at the same time. <ul style="list-style-type: none"> <li>2-sided Print: Long Edge(Available only for certain models)</li> <li>Sleep Time:0Min</li> </ul>
	Toner Save	-	Increase the page yield of the toner cartridge.
	Sleep Time	-	Set how much time will pass before the machine enters Power Saving mode.
	Quiet Mode	-	Decrease printing noise.
	Auto Power Off	-	Set the number of hours that the machine will remain in Deep Sleep mode before going into Power Off mode.
Panel Control	Button Repeat	-	Set the time for the LCD message to change when holding ▲ or ▼ at intervals.
	Message Scroll	-	Set the time in seconds that an LCD message will scroll across the LCD. From Level 1=0.2 sec to Level 10=2.0 sec.
	LCD Contrast	-	Adjust the contrast of the LCD.
	Auto Online	-	Set the machine to return to Ready mode after it has been idle for 30 seconds.
Setting Lock	-	-	Lock your machine's settings using the Setting Lock password.
Interface	Select	-	Select the interface to use. If you select <b>Auto</b> , the machine changes the interface to USB or Network depending on which interface is receiving data.
	Auto IF Time	-	Set the time-out period for the auto interface selection.
	Input Buffer	-	Increase or decrease the input buffer capacity.
Replace Toner	-	-	Sets the machine to continue printing after the LCD displays <b>Replace Toner</b> .

### [Printer]

**For Printer Emulation Supported models**



Level 1	Level 2	Description
Print Options	Font List	Print the font list and samples.
	Test Print	Print a test page.
2-sided (For automatic 2-sided printing models)	2-sided Print	Turn 2-sided printing off or on and select flip on long edge or short edge.
	Single Image	For a print job where the last page is a 1-sided image, select the 1-sided Feed option to reduce printing time.
Auto Continue	-	Select if you want the machine to clear paper size errors or media type errors automatically.
Paper Type	-	Set the type of paper.
Paper Size	-	Set the size of paper.
Copies	-	Set the number of printed pages.
Orientation	-	Set pages to print in either portrait or landscape orientation.
Print Position	X Offset	Move the print start position (at the top-left corner of pages) horizontally up to -500 (left) to +500 (right) dots in 300 dpi.
	Y Offset	Move the print start position (at the top-left corner of pages) vertically up to -500 (up) to +500 (down) dots in 300 dpi.
Auto FF	-	Allow the machine to print any remaining data automatically.
HP LaserJet	Font No.	Set the font number.
	Font Pitch	Set the font pitch. The Font Pitch menu appears when you choose I012 to I018, I031 to I037 or I097 to I109 in Font No. setting.
	Font Point	Set the font size. The Font Point menu appears when you choose I000 to I011, I019 to I030 or I038 to I096 in Font No. setting.
	Symbol Set	Select the symbol or character set.
	Table Print	Print the code table.
	Auto LF	ON: CR -> CR+LF, OFF: CR -> CR
	Auto CR	ON: LF -> LF+CR, FF -> FF+CR, or VT -> VT+CR OFF: LF -> LF, FF -> FF, or VT -> VT
	Auto WRAP	Choose whether a line feed and carriage return will happen when the machine reaches the right margin.
	Auto SKIP	Choose whether a line feed and carriage return will happen when the carriage position reaches the bottom margin.
	Left Margin	Set the left margin at column 0 to 70 columns at 1 cpi.
	Right Margin	Set the right margin at column 10 to 80 columns at 1 cpi.
	Top Margin	Set the top margin distance from the top edge of the paper.
	Bottom Margin	Set the bottom margin distance from the bottom edge of the paper.
	Lines	Set the number of lines on each page.
Tray Command	Select this setting if a tray mismatch appears when you use the HP drivers.	

#### All other models

Level 1	Level 2	Description
Test Print	-	Print a test page.
2-sided	2-sided Print	Turn 2-sided printing off or on and select flip on long edge or short edge.

Level 1	Level 2	Description
(For automatic 2-sided printing models)	<b>Single Image</b>	For a print job where the last page is a 1-sided image, select the 1-sided Feed option to reduce printing time.
<b>Auto Continue</b>	-	Select if you want the machine to clear paper size errors or media type errors automatically.
<b>Print Position</b>	<b>X Offset</b>	Move the print start position (at the top-left corner of pages) horizontally up to -500 (left) to +500 (right) dots in 300 dpi.
	<b>Y Offset</b>	Move the print start position (at the top-left corner of pages) vertically up to -500 (up) to +500 (down) dots in 300 dpi.

### [Network] (HL-L2350DW/HL-L2357DW)

Level 1	Level 2	Level 3	Level 4	Descriptions
<b>WLAN</b>	<b>TCP/IP</b>	<b>Boot Method</b>	-	Choose the IP method that best suits your needs.
		<b>IP Address</b>	-	Enter the IP address.
		<b>Subnet Mask</b>	-	Enter the Subnet mask.
		<b>Gateway</b>	-	Enter the Gateway address.
		<b>Node Name</b>	-	Enter the Node name.
		<b>WINS Config</b>	-	Select the WINS configuration mode.
		<b>WINS Server</b>	<b>Primary</b>	Specify the IP address of the primary WINS server.
			<b>Secondary</b>	Specify the IP address of the secondary WINS server.
		<b>DNS Server</b>	<b>Primary</b>	Specify the IP address of the primary DNS server.
			<b>Secondary</b>	Specify the IP address of the secondary DNS server.
		<b>APIPA</b>	-	Allocate the IP address from the link-local address range automatically <sup>1</sup> .
		<b>IPv6</b>	-	Enable or disable the IPv6 protocol.
		<b>Setup Wizard</b>	-	-
	<b>WLAN Assistant</b>	-	-	Configure your wireless network settings using the Brother installation disc.
	<b>WPS</b>	-	-	Configure your wireless network settings using the one-button push method.
	<b>WPS w/PIN Code</b>	-	-	Configure the wireless network settings using WPS with a PIN code.
	<b>WLAN Status</b>	<b>Status</b>	-	Display the wireless Ethernet link status.
		<b>Signal</b>	-	Display the signal condition.
		<b>Channel</b>	-	Display the channel in use when Status is Active.
		<b>Speed</b>	-	Display the connection speed when Status is Active.
		<b>SSID</b>	-	Display SSID.
		<b>Comm. Mode</b>	-	Display the current Communication mode.
	<b>MAC Address</b>	-	-	Display the MAC address of the machine.

Level 1	Level 2	Level 3	Level 4	Descriptions	
WLAN	WLAN Enable	-	-	Turn the wireless interface on or off.	
Wi-Fi Direct	Push Button	-	-	Configure your Wi-Fi Direct network settings using the one-button push method quickly.	
	PIN Code	-	-	Configure your Wi-Fi Direct network settings using WPS with a PIN code quickly.	
	Manual	-	-	Configure your Wi-Fi Direct network settings manually.	
	Group Owner	-	-	Set your machine as the Group Owner.	
	Device Info.	Device Name	-	-	View your machine's device name.
		SSID	-	-	Display the Group Owner's SSID.
		IP Address	-	-	Display your machine's IP Address.
	Status Info.	Status	-	-	Display the Wi-Fi Direct network status.
		Signal	-	-	Display the current Wi-Fi Direct network signal strength. When your machine acts as Group Owner, the LCD always displays <i>Strong</i> .
		Channel	-	-	Display the channel in use when the Status is <i>G/O Active</i> or <i>Client Active</i> .
Speed		-	-	Display the connection speed when the Status is <i>G/O Active</i> or <i>Client Active</i> .	
I/F Enable	-	-	Enable or disable the Wi-Fi Direct connection.		
Network Reset	-	-	-	Restore all network settings of your machine to the factory settings.	

- <sup>1</sup> On connection to the network, if the machine's 'Boot Method' is 'Auto' the machine will attempt to set the IP address and Subnet Mask from a boot server such as DHCP. If a boot server cannot be found, an APIPA IP address will be allocated, such as 169. 254. [001-254]. [000-255]. If the 'Boot Method' of the machine is set to 'Static' you must manually enter an IP address from the machine's control panel.

## [Network] (HL-L2370DN)

Level 1	Level 2	Level 3	Description	
TCP/IP	Boot Method	-	Choose the IP method that best suits your needs.	
	IP Address	-	Enter the IP address.	
	Subnet Mask	-	Enter the Subnet mask.	
	Gateway	-	Enter the Gateway address.	
	Node Name	-	Enter the Node name.	
	WINS Config	-	Select the WINS configuration mode.	
	WINS Server	Primary	-	Specify the IP address of the primary WINS server.
		Secondary	-	Specify the IP address of the secondary WINS server.
	DNS Server	Primary	-	Specify the IP address of the primary DNS server.
		Secondary	-	Specify the IP address of the secondary DNS server.
APIPA	-	Allocate the IP address from the link-local address range automatically <sup>1</sup> .		
IPv6	-	Enable or disable the IPv6 protocol.		
Ethernet	-	-	Choose the Ethernet link mode.	
Wired Status	-	-	Display the Ethernet link status.	
MAC Address	-	-	Display the MAC address of the machine.	

Level 1	Level 2	Level 3	Description
Network Reset	-	-	Restore all network settings of your machine to the factory settings.

- <sup>1</sup> On connection to the network, if the machine's 'Boot Method' is 'Auto' the machine will attempt to set the IP address and Subnet Mask from a boot server such as DHCP. If a boot server cannot be found, an APIPA IP address will be allocated, such as 169. 254. [001-254]. [000-255]. If the 'Boot Method' of the machine is set to 'Static' you must manually enter an IP address from the machine's control panel.

## [Network] (HL-L2375DW)

Level 1	Level 2	Level 3	Level 4	Descriptions
Wired LAN	TCP/IP	Boot Method	-	Choose the IP method that best suits your needs.
		IP Address	-	Enter the IP address.
		Subnet Mask	-	Enter the Subnet mask.
		Gateway	-	Enter the Gateway address.
		Node Name	-	Enter the Node name.
		WINS Config	-	Select the WINS configuration mode.
		WINS Server	Primary	Specify the IP address of the primary WINS server.
			Secondary	Specify the IP address of the secondary WINS server.
		DNS Server	Primary	Specify the IP address of the primary DNS server.
			Secondary	Specify the IP address of the secondary DNS server.
	APIPA	-	Allocate the IP address from the link-local address range automatically <sup>1</sup> .	
	IPv6	-	Enable or disable the IPv6 protocol.	
	Ethernet	-	-	Choose the Ethernet link mode.
	Wired Status	-	-	Display the Ethernet link status.
MAC Address	-	-	Display the MAC address of the machine.	
Set to Default	-	-	Restore wired network settings of your machine to the factory settings.	
Wired Enable	-	-	Turn the wired interface on or off.	
WLAN	TCP/IP	Boot Method	-	Choose the IP method that best suits your needs.
		IP Address	-	Enter the IP address.
		Subnet Mask	-	Enter the Subnet mask.
		Gateway	-	Enter the Gateway address.
		Node Name	-	Enter the Node name.
		WINS Config	-	Select the WINS configuration mode.
		WINS Server	Primary	Specify the IP address of the primary WINS server.
			Secondary	Specify the IP address of the secondary WINS server.
		DNS Server	Primary	Specify the IP address of the primary DNS server.
			Secondary	Specify the IP address of the secondary DNS server.

Level 1	Level 2	Level 3	Level 4	Descriptions
WLAN	TCP/IP	APIPA	-	Allocate the IP address from the link-local address range automatically <sup>1</sup> .
		IPv6	-	Enable or disable the IPv6 protocol.
	Setup Wizard	-	-	Configure the wireless network settings using the setup wizard.
	WLAN Assistant	-	-	Configure your wireless network settings using the Brother installation disc.
	WPS	-	-	Configure your wireless network settings using the one-button push method.
	WPS w/PIN Code	-	-	Configure the wireless network settings using WPS with a PIN code.
	WLAN Status	Status	-	Display the wireless Ethernet link status.
		Signal	-	Display the signal condition.
		Channel	-	Display the channel in use when Status is Active.
		Speed	-	Display the connection speed when Status is Active.
		SSID	-	Display SSID.
		Comm. Mode	-	Display the current Communication mode.
	MAC Address	-	-	Display the MAC address of the machine.
	Set to Default	-	-	Restore wireless network settings of your machine to the factory settings.
WLAN Enable	-	-	Turn the wireless interface on or off.	
Wi-Fi Direct	Push Button	-	-	Configure your Wi-Fi Direct network settings using the one-button push method quickly.
	PIN Code	-	-	Configure your Wi-Fi Direct network settings using WPS with a PIN code quickly.
	Manual	-	-	Configure your Wi-Fi Direct network settings manually.
	Group Owner	-	-	Set your machine as the Group Owner.
	Device Info.	Device Name	-	View your machine's device name.
		SSID	-	Display the Group Owner's SSID.
		IP Address	-	Display your machine's IP Address.
	Status Info.	Status	-	Display the Wi-Fi Direct network status.
		Signal	-	Display the current Wi-Fi Direct network signal strength. When your machine acts as Group Owner, the LCD always displays Strong.
		Channel	-	Display the channel in use when the Status is G/O Active or Client Active.
		Speed	-	Display the connection speed when the Status is G/O Active or Client Active.
I/F Enable	-	-	Enable or disable the Wi-Fi Direct connection.	
Network Reset	-	-	-	Restore all network settings of your machine to the factory settings.

<sup>1</sup> On connection to the network, if the machine's 'Boot Method' is 'Auto' the machine will attempt to set the IP address and Subnet Mask from a boot server such as DHCP. If a boot server cannot be found, an APIPA IP address will be allocated, such as 169. 254. [001-254]. [000-255]. If the 'Boot Method' of the machine is set to 'Static' you must manually enter an IP address from the machine's control panel.

## [Print Reports]

Level 1	Level 2	Description
Printer Settings	-	Print the Printer Settings page.
Network Config (For network models)	-	Print the Network Configuration Report.
Print File List (Available only for certain models)	-	Print a list of data saved in the memory.
Drum Dot Print	-	Print the Drum Dot Check Sheet.
WLAN Report (For wireless models)	-	Print the wireless LAN connectivity diagnosis result.

## [Machine Info.]

Level 1	Level 2	Description
Serial No.	-	Display the machine's serial number.
Firmware Version	-	Check your machine's firmware version.
Page Counter	-	Display the total printed pages.
Parts Life <sup>1</sup>	Toner Life	Display the remaining life of the toner cartridge.
	Drum Life	Display the remaining life of the drum unit.

<sup>1</sup> Life is approximate and may vary by type of use.

## [Initial Setup]

Level 1	Level 2	Description
Reset	Machine Reset	Restore all the machine settings that you have changed.
	Network Reset	Restore all network settings back to the factory settings.
	Factory Reset	Restores all the machine's settings to the factory defaults. Perform this operation when you dispose of your machine.
Local Language	-	Select the LCD language for your country.



### Related Information

- [Menu Table \(for LCD Models\)](#)

## How to Install the Remote Printer Console Software (Windows® only)

**Related Models:** HL-L2310D

Remote Printer Console is a software application that helps you change many of the printer settings on your Brother machine, regardless of the application you are printing from.

For example, you can change the settings for page margin, Sleep Mode, character set, and so on in Remote Printer Console. These settings are remembered in and used by your Brother machine as print defaults. However, any manual changes you make in the application or printer driver will override your Remote Printer Console settings.

### NOTE

Not available to countries subject to applicable export regulations.

1. Put the Brother Installation Disc into your CD-ROM drive.  
Close the opening screen when it appears.
2. Open Windows® Explorer and select the CD-ROM drive.
3. Double-click the **Tools** folder.
4. Double-click the **RPC** folder.
5. Refer to the **RPC\_User's\_Guide.pdf** for how to install and use the Remote Printer Console.



### Related Information

- [Machine Settings](#)

## Change Machine Settings from Your Computer

- [Change Machine Settings Using Web Based Management](#)
- [Where Can I Find My Brother Machine's Network Settings?](#)
- [Network Management Software and Utilities](#)



## Change Machine Settings Using Web Based Management

Web Based Management is a utility that uses a standard web browser to manage your machine using the Hyper Text Transfer Protocol (HTTP) or Hyper Text Transfer Protocol over Secure Socket Layer (HTTPS).

- [What is Web Based Management?](#)
- [Access Web Based Management](#)
- [Set a Login Password for Web Based Management](#)
- [Network Management Software and Utilities](#)

## What is Web Based Management?

**Related Models:** HL-L2350DW/HL-L2357DW/HL-L2370DN/HL-L2375DW

Web Based Management is a utility that uses a standard web browser to manage your machine using the Hyper Text Transfer Protocol (HTTP) or Hyper Text Transfer Protocol over Secure Socket Layer (HTTPS). Type your machine's IP address into your web browser to access and change your print server settings.



- We recommend Microsoft® Internet Explorer® 11/Edge for Windows® and Safari 9/10 for Mac. Make sure that JavaScript and Cookies are always enabled in whichever browser you use.
- You must use the TCP/IP protocol on your network and have a valid IP address programmed into the print server and your computer.

The screenshot displays the Brother web-based management interface. At the top, there is a header with the placeholder 'XXX-XXXX' and a yellow notification box that says 'Please configure the password >>'. The Brother logo and 'Brother Solutions Center' are in the top right. Below the header are tabs for 'General', 'Print', 'Administrator', and 'Network'. A left sidebar contains a menu with options like 'Status', 'Auto Refresh Interval', 'Maintenance Information', 'Lists/Reports', 'Find Device', 'Contact & Location', 'Sleep Time', 'Auto Power Off', 'Language', 'Panel', and 'Replace Toner'. The main content area is titled 'Status' and shows the following information:

- Device Status:** Ready (indicated by a green bar)
- Automatic Refresh:** Off (radio button selected)
- Toner Level:** BK (with a toner level indicator bar)
- Web Language:** Auto (dropdown menu)
- Device Location:** Contact: (with a person icon) and Location: (with a house icon)

- The actual screen may differ from the screen shown above.



### Related Information

- [Change Machine Settings Using Web Based Management](#)

## Access Web Based Management

**Related Models:** HL-L2350DW/HL-L2357DW/HL-L2370DN/HL-L2375DW

- We recommend using the HTTPS security protocol when configuring settings using Web Based Management.
- When you use HTTPS for Web Based Management configuration, your browser will display a warning dialog box.

1. Start your web browser.
2. Type "http://machine's IP address" in your browser's address bar (where "machine's IP address" is the machine's IP address).

For example:

http://192.168.1.2



- If you are using a Domain Name System or enable a NetBIOS name, you can type another name, such as "SharedPrinter" instead of the IP address.

- For example:

http://SharedPrinter

If you enable a NetBIOS name, you can also use the node name.

- For example:

http://brnxxxxxxxxxxxx

The NetBIOS name can be found in the Network Configuration Report.

- For Mac, access Web Based Management by clicking the machine's icon on the **Status Monitor** screen.

3. No password is required by default. Type a password if you have set one, and then click .

You can now change the print server settings.

If you change the protocol settings, you must restart the machine after clicking **Submit** to activate the configuration.



### Related Information

- [Change Machine Settings Using Web Based Management](#)
- [Print the Network Configuration Report](#)

## Set a Login Password for Web Based Management

**Related Models:** HL-L2350DW/HL-L2357DW/HL-L2370DN/HL-L2375DW

We recommend setting a login password to prevent unauthorised access to Web Based Management.

1. Start your web browser.
2. Type "http://machine's IP address" in your browser's address bar (where "machine's IP address" is the machine's IP address).

For example:

http://192.168.1.2



- If you are using a Domain Name System or enable a NetBIOS name, you can type another name, such as "SharedPrinter" instead of the IP address.

- For example:

http://SharedPrinter

If you enable a NetBIOS name, you can also use the node name.

- For example:

http://brnxxxxxxxxxxxx

The NetBIOS name can be found in the Network Configuration Report.

- For Mac, access Web Based Management by clicking the machine's icon on the **Status Monitor** screen.

3. No password is required by default. Type a password if you have set one, and then click .
4. Click **Administrator**.
5. Type the password you want to use in the **Enter New Password** field (8 to 32 characters).
6. Retype the password in the **Confirm New Password** field.
7. Click **Submit**.

In the future, every time you access Web Based Management, type the password in the **Login** field, and then click .

After configuring the settings, log off by clicking .



- If you have not previously set a login password, you can also set a password by clicking the **Please configure the password** button on the machine's web page.



### Related Information

- [Change Machine Settings Using Web Based Management](#)

## Appendix

- [Specifications](#)
- [How to Enter Text on Your Brother Machine](#)
- [Supplies](#)
- [Information Regarding Recycled Paper](#)
- [Brother Numbers](#)

## Specifications

### General Specifications

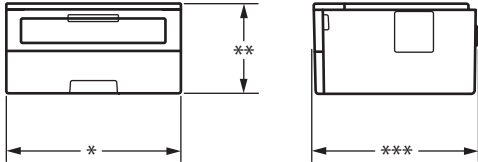
<b>Printer Type</b>		<ul style="list-style-type: none"> <li>Laser</li> </ul>
<b>Print Method</b>		<ul style="list-style-type: none"> <li>Electrophotographic Laser Printer</li> </ul>
<b>Memory Capacity</b>	<b>Standard</b>	<ul style="list-style-type: none"> <li>(HL-L2310D) 32 MB</li> <li>(HL-L2350DW/HL-L2357DW/HL-L2370DN/ HL-L2375DW) 64 MB</li> </ul>
<b>LCD (Liquid Crystal Display)</b>		<ul style="list-style-type: none"> <li>(HL-L2350DW/HL-L2357DW/HL-L2370DN/ HL-L2375DW) 16 characters x 1 line</li> </ul>
<b>Power Source</b>		<ul style="list-style-type: none"> <li>220 to 240 V AC 50/60 Hz</li> </ul>
<b>Power Consumption</b> (Average)	<b>Peak</b>	<ul style="list-style-type: none"> <li>Approximately 1104 W</li> </ul>
	<b>Printing</b> <sup>1</sup>	<ul style="list-style-type: none"> <li>(HL-L2310D/HL-L2350DW/HL-L2357DW) Approximately 460 W at 25 °C</li> <li>(HL-L2370DN/HL-L2375DW) Approximately 510 W at 25 °C</li> </ul>
	<b>Printing (Quiet Mode)</b> <sup>1</sup>	<ul style="list-style-type: none"> <li>Approximately 265 W at 25 °C</li> </ul>
	<b>Ready</b> <sup>1</sup>	<ul style="list-style-type: none"> <li>Approximately 48 W at 25 °C</li> </ul>
	<b>Sleep</b> <sup>1</sup>	<ul style="list-style-type: none"> <li>(HL-L2310D) Approximately 5.7 W</li> <li>(HL-L2350DW/HL-L2357DW/HL-L2370DN/ HL-L2375DW) Approximately 6 W</li> </ul>
	<b>Deep Sleep</b> <sup>1</sup>	<ul style="list-style-type: none"> <li>Approximately 0.6 W</li> </ul>
	<b>Power Off</b> <sup>2 3</sup>	<ul style="list-style-type: none"> <li>Approximately 0.03 W</li> </ul>
<b>Dimensions</b> (Typical outline view) 		Unit: mm <ul style="list-style-type: none"> <li>* : 356</li> <li>** : 183</li> <li>*** : 360</li> </ul>
<b>Weights (with supplies)</b>		<ul style="list-style-type: none"> <li>7.2 kg</li> </ul>

<sup>1</sup> Measured when the machine is connected to the USB interface.

<sup>2</sup> Measured according to IEC 62301 Edition 2.0.

<sup>3</sup> Power consumption varies slightly depending on the usage environment.

<b>Noise Level</b>	<b>Sound Pressure</b>	<b>Printing</b>	<ul style="list-style-type: none"> <li>(HL-L2310D/HL-L2350DW/HL-L2357DW) LpAm = 48 dB (A)</li> <li>(HL-L2370DN/HL-L2375DW) LpAm = 49 dB (A)</li> </ul>
		<b>Printing (Quiet Mode)</b>	<ul style="list-style-type: none"> <li>LpAm = 44 dB (A)</li> </ul>
		<b>Ready</b>	<ul style="list-style-type: none"> <li>LpAm = 30.0 dB (A)</li> </ul>
	<b>Sound Power</b>	<b>Printing<sup>4</sup></b>	<ul style="list-style-type: none"> <li>(HL-L2310D/HL-L2350DW/HL-L2357DW) LWAd = 6.56 B (A)</li> <li>(HL-L2370DN/HL-L2375DW) LWAd = 6.66 B (A)</li> </ul>
		<b>Printing (Quiet Mode)</b>	<ul style="list-style-type: none"> <li>LWAd = 6.14 B (A)</li> </ul>
		<b>Ready<sup>4</sup></b>	<ul style="list-style-type: none"> <li>LWAd = Inaudible</li> </ul>
<b>Temperature</b>	<b>Operating</b>	<ul style="list-style-type: none"> <li>10 to 32 °C</li> </ul>	
	<b>Storage</b>	<ul style="list-style-type: none"> <li>0 to 40 °C</li> </ul>	
<b>Humidity</b>	<b>Operating</b>	<ul style="list-style-type: none"> <li>20 to 80% (without condensation)</li> </ul>	
	<b>Storage</b>	<ul style="list-style-type: none"> <li>35 to 85% (without condensation)</li> </ul>	

## Print Media Specifications

<b>Paper Input</b>	<b>Paper Tray (Standard)</b>	<b>Paper Type</b>	<ul style="list-style-type: none"> <li>Plain Paper, Thin Paper, Recycled Paper, Thick Paper</li> </ul>
		<b>Paper Size</b>	<ul style="list-style-type: none"> <li>A4, Letter, A5, A5 (Long Edge), A6, Executive</li> </ul>
		<b>Paper Weight</b>	<ul style="list-style-type: none"> <li>60 to 163 g/m<sup>2</sup></li> </ul>
		<b>Maximum Paper Capacity</b>	<ul style="list-style-type: none"> <li>Up to 250 sheets of 80 g/m<sup>2</sup> Plain Paper</li> </ul>
	<b>Manual Feed Slot</b>	<b>Paper Type</b>	<ul style="list-style-type: none"> <li>Plain Paper, Thin Paper, Thick Paper, Thicker Paper, Recycled Paper, Bond, Label, Envelope, Env. Thin, Env.Thick</li> </ul>
		<b>Paper Size</b>	<ul style="list-style-type: none"> <li>Width: 76.2 to 215.9 mm</li> <li>Length: 127 to 355.6 mm</li> <li>Envelope: COM-10, DL, C5, Monarch</li> </ul>
		<b>Paper Weight</b>	<ul style="list-style-type: none"> <li>60 to 230 g/m<sup>2</sup></li> </ul>
		<b>Maximum Paper Capacity</b>	<ul style="list-style-type: none"> <li>One sheet at a time</li> </ul>
<b>Paper Output<sup>1</sup></b>	<b>Face Down Output Tray</b>	<ul style="list-style-type: none"> <li>Up to 150 Sheets of 80 g/m<sup>2</sup> Plain Paper (face down delivery to the face down output paper tray)<sup>2</sup></li> </ul>	
	<b>Face Up Output Tray</b>	<ul style="list-style-type: none"> <li>One sheet (face up delivery to the face up output tray)</li> </ul>	
<b>2-sided</b>	<b>Automatic 2-sided Printing</b>	<b>Paper Type</b>	<ul style="list-style-type: none"> <li>Plain Paper, Thin Paper, Recycled Paper</li> </ul>
		<b>Paper Size</b>	<ul style="list-style-type: none"> <li>A4</li> </ul>

<sup>4</sup> Measured in accordance with the method described in RAL-UZ205.

<b>2-sided</b>	<b>Automatic 2-sided Printing</b>	<b>Paper Weight</b>	• 60 to 105 g/m <sup>2</sup>
----------------	-----------------------------------	---------------------	------------------------------

- 1 For labels, we recommend removing the printed sheets from the output paper tray immediately after they exit the machine to avoid the possibility of smudging.
- 2 Calculated with 80 g/m<sup>2</sup> in a temperate, non humid environment.

## Printer Specifications

<b>Automatic 2-sided Print</b>	• Yes
<b>Emulation</b>	• (HL-L2370DN/HL-L2375DW) PCL6
<b>Resolution</b>	• 600 x 600 dpi, HQ1200 (2400 x 600 dpi) quality, 1200 x 1200 dpi
<b>Print Speed</b> <sup>5 6</sup>	<b>1-sided print</b> • (HL-L2310D/HL-L2350DW/HL-L2357DW) Up to 30 pages/minute (A4 size) Up to 32 pages/minute (Letter size) • (HL-L2370DN/HL-L2375DW) Up to 34 pages/minute (A4 size) Up to 36 pages/minute (Letter size)
	<b>2-sided Print</b> • (HL-L2310D/HL-L2350DW/HL-L2357DW) Up to 15 sides/minute (Up to 7.5 sheets/minute) (Letter or A4 size) • (HL-L2370DN/HL-L2375DW) Up to 16 sides/minute (Up to 8 sheets/minute) (A4 size) Up to 17 sides/minute (Up to 8.5 sheets/minute) (Letter size)
<b>First Print Time</b> <sup>7</sup>	• Less than 8.5 seconds at 23 °C / 230 V

## Interface Specifications

<b>USB</b> <sup>1 2</sup>	• Hi-Speed USB 2.0 Use a USB 2.0 interface cable that is no more than 2.0 metres long.
<b>LAN</b>	• (HL-L2370DN/HL-L2375DW) 10Base-T/100Base-TX <sup>3</sup>
<b>Wireless LAN</b>	• (HL-L2350DW/HL-L2357DW/HL-L2375DW) IEEE 802.11b/g/n (Infrastructure Mode) IEEE 802.11g/n (Wi-Fi Direct <sup>®</sup> )

- 1 Your machine has a USB 2.0 Hi-Speed interface. The machine can also be connected to a computer that has a USB 1.1 interface.
- 2 Third party USB ports are not supported.
- 3 Use a straight-through Category 5 (or greater) twisted-pair cable.

## Supported Protocols and Security Features

### Ethernet

10Base-T/100Base-TX

### Wireless LAN

IEEE 802.11b/g/n (Infrastructure Mode), IEEE 802.11g/n (Wi-Fi Direct)

- 5 The print speed may change depending on the type of document you print.
- 6 Print speed may be slower when the machine is connected by wireless LAN.
- 7 From Ready mode and standard tray



## Protocols (IPv4)

ARP, RARP, BOOTP, DHCP, APIPA(Auto IP), WINS/NetBIOS name resolution, DNS Resolver, mDNS, LLMNR responder, LPR/LPD, Custom Raw Port/Port9100, SMTP Client, IPP/IPPS, FTP Server, SNMPv1/v2c/v3, HTTP/HTTPS server, TFTP client and server, ICMP, Web Services (Print)

## Protocols (IPv6)

NDP, RA, DNS resolver, mDNS, LLMNR responder, LPR/LPD, Custom Raw Port/Port9100, IPP/IPPS, SMTP Client, FTP Server, SNMPv1/v2c/v3, HTTP/HTTPS server, TFTP client and server, ICMPv6, Web Services (Print)

## Network Security (Wired)

SMTP-AUTH, SNMP v3,SSL/TLS (SMTP, HTTP, IPP)

## Network Security (Wireless)

SMTP-AUTH, SNMP v3, SSL/TLS (SMTP, HTTP, IPP)

## Wireless Network Security

WEP 64/128 bit, WPA-PSK (TKIP/AES), WPA2-PSK (TKIP/AES)(Wi-Fi Direct supports WPA2-PSK (AES) only)

## Wireless Certification

Wi-Fi Certification Mark License (WPA™/WPA2™ - Personal), Wi-Fi Protected Setup (WPS) Identifier Mark License, Wi-Fi CERTIFIED™ Wi-Fi Direct

## Computer Requirements Specifications

Supported Operating Systems And Software Functions

Computer Platform & Operating System Version		PC Interface				Processor	Hard Disk Space to Install
		Parallel (IEEE1284)	USB <sup>1</sup>	10BASE-T/100BASE-TX (Ethernet)	Wireless <sup>2</sup> 802.11b/g/n		
Windows® Operating System	Windows® 7 SP1 / 8 / 8.1	N/A	Printing		32 bit (x86) or 64 bit (x64) processor	80 MB	
	Windows® 10 Home / 10 Pro / 10 Education / 10 Enterprise						
	Windows Server® 2008		Printing				
	Windows Server® 2008 R2				64 bit (x64) processor		
	Windows Server® 2012						
	Windows Server® 2012 R2						
	Windows Server® 2016						
Mac Operating System	macOS v10.10.5	Printing		Intel® Processor	80 MB		
	macOS v10.11.x						
	macOS v10.12.x						

<sup>1</sup> Third party USB ports are not supported.

<sup>2</sup> HL-L2350DW/HL-L2357DW/HL-L2375DW

---

For the latest driver updates, go to your model's **Downloads** page on the Brother Solutions Center at [support.brother.com](http://support.brother.com).

All trademarks, brand and product names are the property of their respective companies.



## Related Information

- [Appendix](#)

## How to Enter Text on Your Brother Machine

**Related Models:** HL-L2350DW/HL-L2357DW/HL-L2370DN/HL-L2375DW

When text is required, enter characters on the machine. The characters that are available may differ depending on the operation you perform.

- Hold down or repeatedly press ▲ or ▼ to select a character from this list:  
0123456789abcdefghijklmnopqrstuvwxyzABCDEFGHIJKLMNOPQRSTUVWXYZ(space)!"#\$%&'()\*+,-./:;<=>?  
@[^\_
- Press **OK** when the character or symbol you want is displayed, and then enter the next character.
- Press **Back** to delete characters entered incorrectly.



### Related Information

- [Appendix](#)
- [Configure Your Machine for a Wireless Network Using the Machine's Control Panel Setup Wizard](#)
- [Configure Your Machine for a Wireless Network When the SSID Is Not Broadcast](#)

## Supplies

When the time comes to replace supplies, such as the toner or drum, an error message will appear on your machine's control panel or in the Status Monitor. For more information about the supplies for your machine, visit [www.brother.com/original/index.html](http://www.brother.com/original/index.html) or contact your local Brother dealer.



- The Supply Model Name will vary depending on your country and region.

### Toner Cartridge

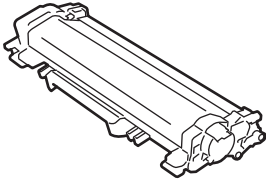

Standard Toner:		
Supply Model Name	Approximate Life (Page Yield)	Applicable Models
TN-2410	Approximately 1,200 pages <sup>1 2</sup>	HL-L2310D/HL-L2350DW/ HL-L2357DW/HL-L2370DN/ HL-L2375DW

<sup>1</sup> Approximate cartridge yield is declared in accordance with ISO/IEC 19752.

<sup>2</sup> A4/Letter single-sided pages

High Yield Toner:		
Supply Model Name	Approximate Life (Page Yield)	Applicable Models
TN-2420	Approximately 3,000 pages <sup>1 2</sup>	HL-L2310D/HL-L2350DW/ HL-L2357DW/HL-L2370DN/ HL-L2375DW

<sup>1</sup> Approximate cartridge yield is declared in accordance with ISO/IEC 19752.

<sup>2</sup> A4/Letter single-sided pages

The average inbox toner life is estimated at approximately 700 pages <sup>1</sup> or approximately 1,200 pages <sup>2</sup> based on 1 page per job [A4 or Letter size single-sided pages].

<sup>1</sup> HL-L2310D/HL-L2350DW/HL-L2370DN

<sup>2</sup> HL-L2357DW/HL-L2375DW

### Drum Unit

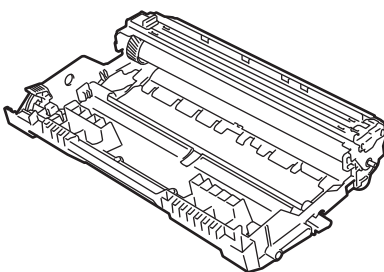

Supply Model Name	Approximate Life (Page Yield)	Applicable Models
DR-2400	Approximately 12,000 pages <sup>1</sup>	HL-L2310D/HL-L2350DW/HL-L2357DW/HL-L2370DN/ HL-L2375DW

<sup>1</sup> Approximately 12,000 pages based on 1 page per job [A4/Letter single-sided pages]. The number of pages may be affected due to a variety of factors including but not limited to media type and media size.



## Related Information

- [Appendix](#)
  - [Replace Supplies](#)
-

## Information Regarding Recycled Paper

- Recycled paper is of the same quality as paper made from original forest sources. Standards governing modern recycled paper ensure that it meets the highest quality requirements for different printing processes. The imaging equipment supplied by the VA signatories is suitable for using with recycled paper meeting the EN 12281:2002 standard.
- Purchasing recycled paper saves natural resources and promotes the circular economy. Paper is made using cellulose fibres from wood. Collecting and recycling paper extends the life of fibres over multiple life cycles, making the best use of the resources.
- The recycled paper production process is shorter. The fibres have already been processed, so less water and energy, and fewer chemicals are used.
- Paper recycling has the benefit of saving carbon by diverting paper products from alternative disposal routes such as landfill and incineration. Landfill waste emits methane gas, which has a powerful greenhouse effect.



### Related Information

- [Appendix](#)

## Brother Numbers

### IMPORTANT

For technical help, you must contact Brother customer service or your local Brother Dealer.

### FAQs (Frequently Asked Questions)

The Brother Solutions Center is our one-stop resource for all your machine needs. Download the latest software and utilities and read FAQs and Troubleshooting tips to learn how to get the most from your Brother product.

Check here for Brother driver updates, too.

[support.brother.com](http://support.brother.com)

### Customer Service

Visit [www.brother.com](http://www.brother.com) for contact information on your local Brother office.

### Service Centre locations

For service centres in Europe, contact your local Brother Office. Contact information for European offices can be found by going to [www.brother.com](http://www.brother.com), and selecting your region and country.

#### Internet Addresses

Brother Global Web Site: [www.brother.com](http://www.brother.com)

For Frequently Asked Questions (FAQs), Product Support and Technical Questions, and Driver Updates and Utilities:

[support.brother.com](http://support.brother.com)



### Related Information

- [Appendix](#)

# brother

Visit us on the World Wide Web  
[www.brother.com](http://www.brother.com)





## Free Manuals Download Website

<http://myh66.com>

<http://usermanuals.us>

<http://www.somanuals.com>

<http://www.4manuals.cc>

<http://www.manual-lib.com>

<http://www.404manual.com>

<http://www.luxmanual.com>

<http://aubethermostatmanual.com>

Golf course search by state

<http://golfingnear.com>

Email search by domain

<http://emailbydomain.com>

Auto manuals search

<http://auto.somanuals.com>

TV manuals search

<http://tv.somanuals.com>