



**BOSCH**



**Register** your  
new device on  
MyBosch now and  
get free benefits:  
**[bosch-home.com/  
welcome](https://bosch-home.com/welcome)**

# Free standing cooker

**HGL120B50Q, HGA120B20Q**

**[en]** Instruction manual

Free standing cooker



# Table of contents

 <b>Intended use</b> . . . . .	<b>4</b>	 <b>Cleaning</b> . . . . .	<b>19</b>
 <b>Important safety information</b> . . . . .	<b>5</b>	Cleaning agents . . . . .	19
 <b>Causes of damage</b> . . . . .	<b>7</b>	Keeping the appliance clean . . . . .	21
Hob . . . . .	7	 <b>Rails</b> . . . . .	<b>22</b>
Damage to the oven. . . . .	7	Detaching and refitting the rails . . . . .	22
 <b>Environmental protection</b> . . . . .	<b>8</b>	 <b>Appliance door</b> . . . . .	<b>23</b>
Saving energy . . . . .	8	Detaching and attaching the oven door . . . . .	23
Saving energy with the gas hob. . . . .	8	Additional door safety. . . . .	23
Environmentally-friendly disposal . . . . .	8	 <b>Trouble shooting</b> . . . . .	<b>24</b>
 <b>Installation and connection</b> . . . . .	<b>9</b>	Fault table. . . . .	24
Gas connection . . . . .	9	Replacing the bulb in the oven ceiling light . . . . .	24
Electrical connection . . . . .	9	Glass cover . . . . .	24
Horizontal alignment . . . . .	10	 <b>Customer service</b> . . . . .	<b>25</b>
Adjacent units . . . . .	10	E number and FD number . . . . .	25
Wall fixing. . . . .	10	 <b>Tested for you in our cooking studio</b> . . . . .	<b>25</b>
Setting up the appliance . . . . .	10	Cakes and pastries. . . . .	26
Measures to be noted during transport . . . . .	10	Baking tips . . . . .	26
 <b>Getting to know your appliance</b> . . . . .	<b>11</b>	Meat, poultry, fish, toast . . . . .	27
General information . . . . .	11	Tips for roasting and grilling. . . . .	27
Cooking area . . . . .	11	Yoghurt. . . . .	28
Control panel . . . . .	12	Acrylamide in foodstuffs . . . . .	28
The cooking compartment. . . . .	12		
 <b>Accessories</b> . . . . .	<b>13</b>		
Accessories included. . . . .	13		
Inserting accessories . . . . .	13		
Optional accessories . . . . .	13		
 <b>Before using for the first time</b> . . . . .	<b>14</b>		
Heating up the oven. . . . .	14		
Setting the oven's lower gas burner. . . . .	14		
Setting the gas grill on the oven . . . . .	15		
Cleaning the accessories. . . . .	15		
 <b>Cooking pans</b> . . . . .	<b>16</b>		
Precautions for use . . . . .	16		
 <b>Gas burners</b> . . . . .	<b>17</b>		
Advance cleaning of burner cup and cap . . . . .	17		
Igniting the gas burners . . . . .	17		
Warnings . . . . .	17		
Table - Cooking . . . . .	17		
 <b>Operating the appliance</b> . . . . .	<b>18</b>		
Setting the oven's lower gas burner. . . . .	18		
Setting the gas grill on the oven . . . . .	19		

---

Additional information on products, accessories, replacement parts and services can be found at [www.bosch-home.com](http://www.bosch-home.com) and in the online shop [www.bosch-eshop.com](http://www.bosch-eshop.com)

## Intended use

Read these instructions carefully. Only then will you be able to operate your appliance safely and correctly. Retain the instruction manual and installation instructions for future use or for subsequent owners.

The images shown in these instructions are for guidance only.

### **Appliance category:** Category 1

Check the appliance for damage after unpacking it. Do not connect the appliance if it has been damaged in transport.

Only allow a licensed professional to connect the appliance and to convert the appliance to a different type of gas. The appliance must be installed (electric and gas connections) in accordance with the instruction and installation manual. An incorrect connection or incorrect settings may lead to serious accidents and damage to the appliance. The appliance manufacturer accepts no liability for damage of this kind. The appliance's warranty becomes void.

This appliance is intended for private domestic use and the household environment only. The appliance must only be used for the preparation of food and beverages. The cooking process must be supervised. A short cooking process must be supervised without interruption. Only use the appliance in enclosed spaces.

**Caution:** This appliance is for cooking purposes only. It must not be used for other purposes, for example room heating.

This appliance is intended for use up to a maximum height of 2000 metres above sea level.

**CAUTION:** Observe the applicable regulations and only set up the appliance in well-ventilated rooms. Read the instructions before setting up and using the appliance.

**Caution:** The use of a gas cooking appliance results in the production of heat, moisture and products of combustion in the room in which it is installed. Ensure that the kitchen is well ventilated especially when the appliance is in use: keep natural ventilation holes open or install a mechanical ventilation device (mechanical extractor hood).

Prolonged intensive use of the appliance may call for additional ventilation, for example

opening of a window, or more effective ventilation, for example increasing the level of mechanical ventilation where present.

### **⚠ Warning – WHAT TO DO IF YOU SMELL GAS!**

Escaping gas may cause an explosion.

#### **If you smell gas or notice any faults in the gas installation:**

- Immediately shut off the gas supply or close the gas cylinder valve.
- Immediately extinguish all naked flames and cigarettes.
- Do not use any light or appliance switches and do not pull any plugs out of sockets. Do not use any telephones or mobile phones within the building.
- Open windows and ventilate the room.
- Call the after-sales service or the gas supplier.

This appliance is not designed for operation with an external timer or by remote control.

Do not use inappropriate child safety shields or hob guards. These can cause accidents.

This appliance may be used by children over the age of 8 years old and by persons with reduced physical, sensory or mental capabilities or by persons with a lack of experience or knowledge if they are supervised or are instructed by a person responsible for their safety how to use the appliance safely and have understood the associated hazards.

Children must not play with, on, or around the appliance. Children must not clean the appliance or carry out general maintenance unless they are at least 15 years old and are being supervised.

Keep children below the age of 8 years old at a safe distance from the appliance and power cable.

Always slide accessories into the cooking compartment the right way round.

→ "Accessories" on page 13

Mechanical abrasion on baking trays can cause some of the aluminium to be removed, and acidic, alkaline and salty foods can cause the aluminium to dissolve, for example due to fruit acid or baked goods dipped in a lye solution. Do not place food directly onto the baking tray. Line the baking tray with greaseproof paper. Do not use sharp metal objects. Do not use aggressive or abrasive cleaning agents.

## Important safety information

### Warning – Risk of fire!

- A draught is created when the appliance door is opened. Greaseproof paper may come into contact with the heating element and catch fire. Do not place greaseproof paper loosely over accessories during preheating. Always weight down the greaseproof paper with a dish or a baking tin. Only cover the surface required with greaseproof paper. Greaseproof paper must not protrude over the accessories.
- Combustible objects that are left in the cooking compartment may ignite. Never store combustible items in the cooking compartment. Never open the appliance door if there is smoke inside. Switch off the appliance and unplug the mains plug or switch off the fuse in the fuse box. Shut off the gas supply.
- Hot oil and fat can ignite very quickly. Never leave hot fat or oil unattended. Never use water to put out burning oil or fat. Switch off the hotplate. Extinguish flames carefully using a lid, fire blanket or something similar.
- The hotplates become very hot. Never place combustible items on the hob. Never place objects on the hob.
- The appliance becomes very hot, and flammable materials can easily catch fire. Do not store or use any flammable objects (e.g. aerosol cans, cleaning agents) under or in the vicinity of the oven. Do not store any flammable objects inside or on top of the oven.
- When gas hotplates are in operation without any cookware placed on them, they can build up a lot of heat. The appliance and the extractor hood above it may become damaged or be set on fire. Grease residue in the filter of the extractor hood may ignite. Only operate the gas burners with cookware on them.
- The rear of the appliance becomes very hot. This may cause damage to the power cables. Electricity and gas lines must not come into contact with the rear of the appliance.

- Never place flammable objects on the burners or store them in the cooking compartment. Never open the appliance door if there is smoke inside. Switch off the appliance. Pull out the mains plug or switch off the appliance at the circuit breaker in the fuse box. Shut off the gas supply.

### Warning – Risk of burns!

- The appliance becomes very hot. Never touch the interior surfaces of the cooking compartment or the heating elements. Always allow the appliance to cool down. Keep children at a safe distance.
- Accessories and ovenware become very hot. Always use oven gloves to remove accessories or ovenware from the cooking compartment.
- Alcoholic vapours may catch fire in the hot cooking compartment. Never prepare food containing large quantities of drinks with a high alcohol content. Only use small quantities of drinks with a high alcohol content. Open the appliance door with care.
- The hotplates and surrounding area (particularly the hob surround, if fitted) become very hot. Never touch the hot surfaces. Keep children at a safe distance.
- During operation, the surfaces of the appliance become hot. Do not touch the surfaces when they are hot. Keep children away from the appliance.
- Empty cookware becomes extremely hot when set on a gas hotplate that is in operation. Never heat up empty cookware.
- The appliance becomes hot during operation. Allow the appliance to cool down before cleaning.
- **Caution:** Accessible parts may be hot when the grill is in use. Young children should be kept away from the appliance.
- If the liquefied gas bottle is not upright, liquefied propane/butane can enter the appliance. Intense darting flames may therefore escape from the burners. Components may become damaged and start to leak over time so that gas escapes uncontrollably. Both can cause burns. Always use liquefied gas bottles in an upright position.

### Warning – Risk of scalding!

- The accessible parts become hot during operation. Never touch the hot parts. Keep children at a safe distance.

- When you open the appliance door, hot steam can escape. Steam may not be visible, depending on its temperature. When opening, do not stand too close to the appliance. Open the appliance door carefully. Keep children away.
- Water in a hot cooking compartment may create hot steam. Never pour water into the cooking compartment when the cooking compartment is hot.

**⚠ Warning – Risk of injury!**

- Scratched glass in the appliance door may develop into a crack. Do not use a glass scraper, sharp or abrasive cleaning aids or detergents.
- Incorrect repairs are dangerous. Repairs may only be carried out, and damaged power and gas lines replaced, by an after-sales engineer trained by us. If the appliance is faulty, unplug the mains plug or switch off the fuse in the fuse box. Shut off the gas supply. Contact the after-sales service.
- Faults or damage to the appliance are dangerous. Never switch on a faulty appliance. Unplug the appliance from the mains or switch off the circuit breaker in the fuse box. Shut off the gas supply. Contact the after-sales service.
- Unsuitable pan sizes, damaged or incorrectly positioned pans can cause serious injury. Observe the instructions which accompany the cookware.
- If the appliance is placed on a base and is not secured, it may slide off the base. The appliance must be fixed to the base.
- If you leave the appliance door open, people may bump into it, resulting in injury. The appliance door must be kept closed both while the appliance is in operation and when it has finished.

**⚠ Warning – Risk of tipping!**

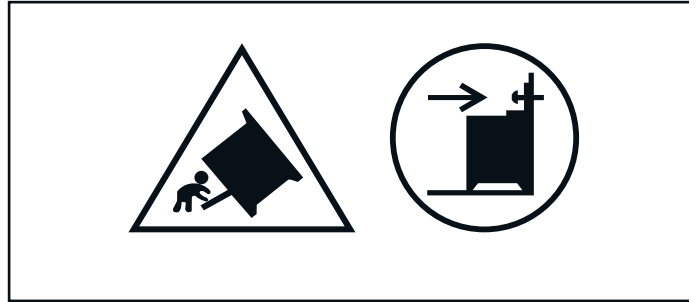

**Warning:** In order to prevent tipping of the appliance, this stabilizing means must be installed. Refer to the instructions for installation.

**⚠ Warning – Risk of electric shock!**

- Incorrect repairs are dangerous. Repairs may only be carried out by one of our trained after-sales engineers. If the appliance is faulty, unplug the mains plug or switch off the fuse in the fuse box. Contact the after-sales service.
- The cable insulation on electrical appliances may melt when touching hot parts of the appliance. Never bring electrical appliance cables into contact with hot parts of the appliance.
- Do not use any high-pressure cleaners or steam cleaners, which can result in an electric shock.
- When replacing the cooking compartment bulb, the bulb socket contacts are live. Before replacing the bulb, unplug the appliance from the mains or switch off the circuit breaker in the fuse box.
- A defective appliance may cause electric shock. Never switch on a defective appliance. Unplug the appliance from the mains or switch off the circuit breaker in the fuse box. Contact the after-sales service.

## Causes of damage

### Hob

#### Caution!

- Only use the burners when cookware has been placed on top. Do not heat up empty pots or pans. The saucepan base will be damaged.
- Only use pots and pans with an even base.
- Place the pot or pan centrally over the burner. This will optimise transfer of the heat from the burner flame to the pot or pan base. The handle does not become damaged, and greater energy savings are guaranteed.
- Observe the manufacturer's instructions when using special ovenware. Aluminium foil and plastic containers can melt and stick on hot burners.
- Ensure that the gas burners are clean and dry. The burner cup and burner cap must be positioned exactly.
- Clear up spills immediately. Use deep pots for dishes with a lot of liquid. This will prevent the food from boiling over.
- Cooking on gas burners releases extra heat and moisture. Adjacent units may become damaged over time. For long cooking times, switch on the cooker hood or ventilate the room.

### Damage to the oven

#### Caution!

- Accessories, foil, greaseproof paper or ovenware on the cooking compartment floor: do not place accessories on the cooking compartment floor. Do not cover the cooking compartment floor with any sort of foil or greaseproof paper. Do not place ovenware on the cooking compartment floor if a temperature of over 50 °C has been set. This will cause heat to accumulate. The baking and roasting times will no longer be correct and the enamel will be damaged.
- Aluminium foil: Aluminium foil in the cooking compartment must not come into contact with the door glass. This could cause permanent discolouration of the door glass.
- Water in a hot cooking compartment: do not pour water into the cooking compartment when it is hot. This will cause steam. The temperature change can cause damage to the enamel.
- Moisture in the cooking compartment: Over an extended period of time, moisture in the cooking compartment may lead to corrosion. Allow the cooking compartment to dry after use. Do not keep moist food in the closed cooking compartment for extended periods of time. Do not store food in the cooking compartment.
- Cooling with the appliance door open: Following operation at high temperatures, only allow the cooking compartment to cool down with the door closed. Do not trap anything in the appliance door. Even if the door is only left open a crack, the front of nearby furniture may become damaged over time. Only leave the cooking compartment to dry with the door open if a lot of moisture was produced whilst the oven was operating.

- Fruit juice: when baking particularly juicy fruit pies, do not pack the baking tray too generously. Fruit juice dripping from the baking tray leaves stains that cannot be removed. If possible, use the deeper universal pan.
- Extremely dirty seal: If the seal is very dirty, the appliance door will no longer close properly during operation. The fronts of adjacent units could be damaged. Always keep the seal clean. Never operate the appliance if the seal is damaged or missing. → *"Cleaning" on page 19*
- Appliance door as a seat, shelf or worktop: Do not sit on the appliance door, or place or hang anything on it. Do not place any cookware or accessories on the appliance door.
- Inserting accessories: depending on the appliance model, accessories can scratch the door panel when closing the appliance door. Always insert the accessories into the cooking compartment as far as they will go.
- Carrying the appliance: do not carry or hold the appliance by the door handle. The door handle cannot support the weight of the appliance and could break.

## Environmental protection

Your new appliance is particularly energy-efficient. Here you can find tips on how to save even more energy when using the appliance, and how to dispose of your appliance properly.

### Saving energy

- Only preheat the appliance if this is specified in the recipe or in the tables in the operating instructions.
- Leave frozen food to defrost before placing it in the cooking compartment.

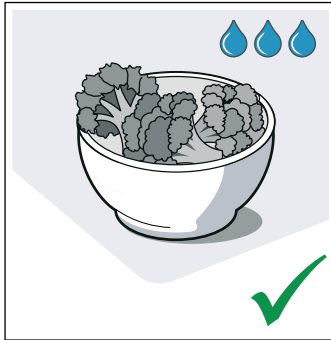
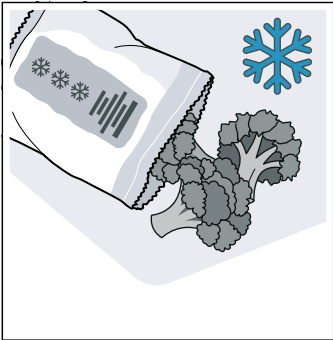

- Use baking tins that are dark-coloured, painted black or have an enamel coating. These absorb the heat particularly well.

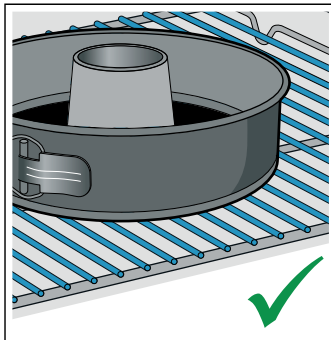
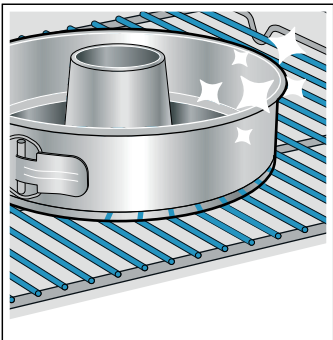

- Remove any unnecessary accessories from the cooking compartment.

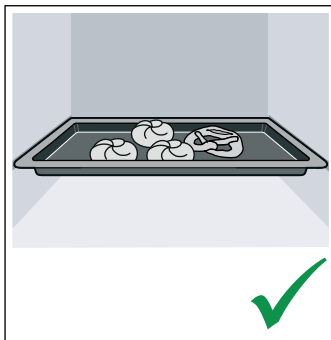
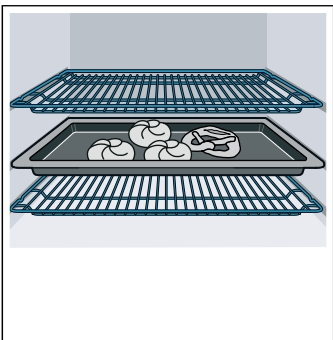

- Open the appliance door as infrequently as possible when the appliance is in use.

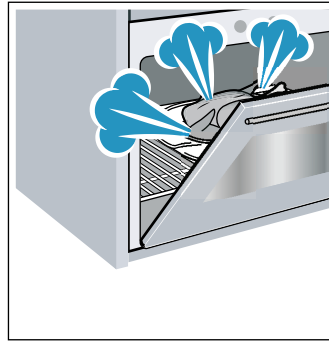

- It is best to bake several cakes one after the other. The cooking compartment stays warm. This reduces the baking time for the second cake. You can place two cake tins next to each other in the cooking compartment.

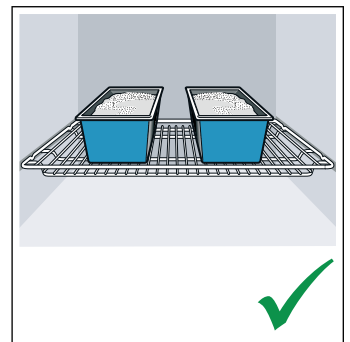
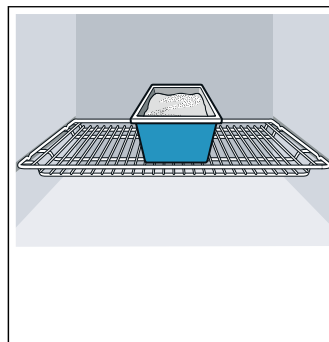

- For longer cooking times, you can switch the appliance off 10 minutes before the end of the cooking time and use the residual heat to finish cooking.

### Saving energy with the gas hob

- Always use a saucepan which is the correct size for your food. A larger, less full saucepan requires a lot of energy.
- Always place a suitable lid on the saucepan.
- The gas flame must always be in contact with the base of the saucepan.

### Environmentally-friendly disposal

Dispose of packaging in an environmentally-friendly manner.



This appliance is labelled in accordance with European Directive 2012/19/EU concerning used electrical and electronic appliances (waste electrical and electronic equipment - WEEE). The guideline determines the framework for the return and recycling of used appliances as applicable throughout the EU.



## Installation and connection

Do not install the appliance behind a decorative door or the door of a kitchen unit, as this may cause the appliance to overheat.

### Gas connection

Installation must only be performed by an approved expert or a licensed after-sales service engineer in accordance with the instructions specified under "Gas connection and conversion to a different gas type".

#### For the licensed expert or after-sales service

##### Caution!

- The setting conditions for this appliance are specified on the rating plate on the back of the appliance. The gas type set in the factory is marked with an asterisk (\*).
- Before setting up the appliance, check the grid access conditions (gas type and gas pressure) and ensure that the gas setting of the appliance meets these conditions. If the appliance settings have to be changed, follow the instructions in the section "Gas connection and conversion to a different gas type".
- This appliance is not connected to a waste gas main. It must be connected and commissioned in accordance with the installation conditions. Do not connect the appliance to a waste gas main. All ventilation regulations must be observed.
- The gas connection must be made via a fixed, i.e. not mobile connection (gas line) or via a safety hose.
- If using the safety hose, ensure that the hose is not trapped or crushed. The hose must not come into contact with hot surfaces.
- \* The gas line (gas pipe or gas safety hose) can be connected to the right- or left-hand side of the appliance. The connection must have an easily accessible shut-off device.  
\* Optional. Available for some appliances.

#### Target appliance operating pressure

Your appliance's target operating pressure is specified on the rating plate on the back of the appliance.

All the data on your appliance's rating plate relates to these pressure values. The manufacturer shall not be held liable for results, performance or any risk caused by operating the appliance at pressure values other than those specified.

##### **Warning – Safety information!**

If the gas pressure in your distributing pipes is higher (20%) than the values specified on the appliance's rating plate, it is important that you operate the appliance with a suitable gas regulator for your safety. If you do not know what the gas pressure in your distributing pipes is, contact your local gas company. The gas regulator must be connected, maintained and adjusted by specialists from your local gas company.

### Faults in the gas installation/smell of gas

If you notice a smell of gas or faults in the gas installation, you must

- immediately shut off the gas supply and/or close the gas cylinder valve
- immediately extinguish all naked flames and cigarettes
- open windows and ventilate the room
- call the after-sales service or the gas supplier

### Moving the appliance by the gas line or door handle

Do not move the appliance while holding the gas line; the gas pipe could be damaged. There is a risk of a gas leak! Do not move the appliance while holding it by the door handle. The door hinges and door handle could be damaged.

### Electrical connection

The appliance is designed to operate at 220-240 V. A 16 A fuse is required for connection.

Have the appliance installed by your after-sales service.

Any damage arising from the appliance being connected incorrectly will invalidate the warranty.

##### Caution!

- If the electricity supply drops below 180 V, the electrical ignition system does not work.
- If the supply cord is damaged, it must be replaced by the manufacturer, its service agent or similarly qualified persons in order to avoid a hazard.

##### **Warning – Danger of death!**

There is a risk of electric shock if you touch live components.

- Always make sure your hands are dry when you touch or hold the mains plug.
- Only pull out the mains cable by taking hold of the plug and removing the plug; never pull it out by the mains cable itself, as this could damage it.
- Never unplug the mains plug when the appliance is in operation.

Please note the following information and ensure that:

##### Notes

- The mains plug fits the socket.
- The cable cross section is adequate.
- The earthing system is properly installed.
- The mains cable is only replaced by a qualified electrician (if this is necessary). Spare mains cables can be ordered from our after-sales service.
- No power strips/multi-way connectors or extension cables are used.
- If using a residual current device, only use one that bears the mark .  
The presence of this mark is the only way to be sure that it fulfils all the applicable regulations.
- The mains plug can be accessed at all times.
- The mains cable is not kinked, crushed, modified or severed.
- The mains cable does not come into contact with heat sources.

## For the after-sales service

### Caution!

- The appliance must be connected in accordance with the data on the rating plate.
- Only connect the appliance to an electrical connection that meets the applicable provisions. The socket must be easily accessible so that you can disconnect the appliance from the electricity supply if necessary.
- Please ensure the availability of a multi-pin disconnecting system.
- Never use extension cables or multiple plugs.
- For safety reasons, this appliance must only be connected to an earthed connection. If the safety earth terminal does not comply with regulations, safety against electrical hazards is not guaranteed.
- You must use a H 05 W-F type cable or equivalent for the appliance connection.

## Horizontal alignment

Always place the appliance directly on the kitchen floor.

The appliance is equipped with height-adjustable feet. You can raise the appliance approximately 15 mm by adjusting the feet.

You can adjust the feet, using a spanner, to ensure that the appliance is horizontal.

## Adjacent units

Any adjacent units must not be made of flammable materials. The fronts of any adjacent units must be heat-resistant up to at least 90 °C.

## Wall fixing

To prevent the cooker from tipping over, you must fix it to the wall using the enclosed bracket. Please observe the installation instructions for fixing the oven to the wall.

## Setting up the appliance

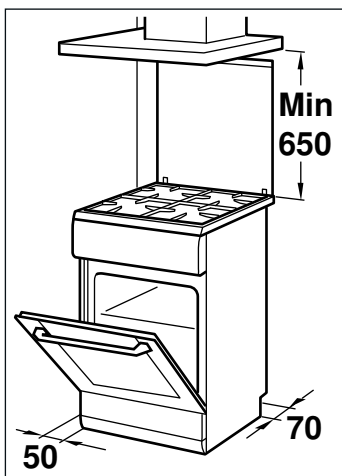

- The appliance must be set up directly on the kitchen floor and in line with the specified dimensions. The appliance must not be set up on any other object.

- The distance between the top edge of the oven and the bottom edge of the extractor hood must meet the requirements of the extractor hood manufacturer.
- Ensure that the appliance is not moved again after set up. The distance from the high output burner or wok burner to the fronts of the adjacent units or the wall must be at least 50 mm.

### **Warning – Risk of gas leak!**

The appliance must not be moved once it has been installed.

If you do move the appliance once it has been installed, check that the connection is leak-tight.

## Measures to be noted during transport

Secure all mobile parts in and on the appliance using an adhesive tape that can be removed without leaving any traces. Push all accessories (e.g. baking tray) into the corresponding slots with cardboard at the edges, in order to avoid damaging the appliance. Place cardboard or similar between the front and rear side to prevent knocks against the inside of the glass door. Secure the door and, if available, the top cover to the appliance sides using adhesive tape.

Keep the original appliance packaging. Only transport the appliance in the original packaging. Observe the transport arrows on the packaging.

### If the original packaging is no longer available

pack the appliance in protective packaging to guarantee sufficient protection against any transport damage.

Transport the appliance in an upright position. Do not hold the appliance by the door handle or the connections on the rear, as these could be damaged. Do not place any heavy objects on the appliance.

## Getting to know your appliance

In this section, we will explain the indicators and controls. You will also find out about the various functions of your appliance.

### General information

The design depends on the respective appliance model.

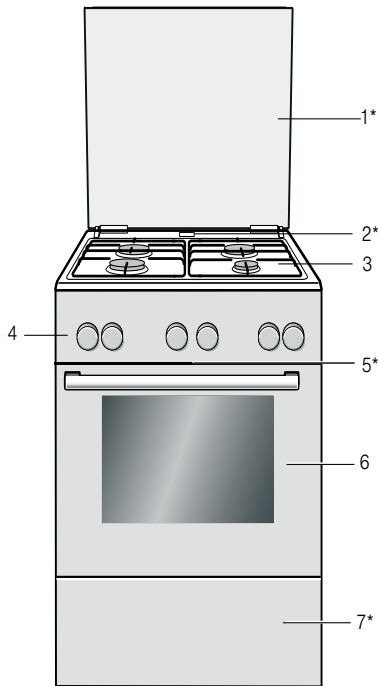

#### Explanations

1*	Hob cover**
2*	Steam outlet <b>Caution!</b> When the oven is in operation, hot steam escapes here.
3	Hob**
4	Control panel**
5*	Cooling fan
6	Oven door**
7*	Plinth drawer**

\* Optional (available for some appliances)

\*\* Depending on the appliance model, details may vary.

**Note:** Depending on the appliance model, individual details and colours may differ.

### Cooking area

Here is an overview of the control panel. The design depends on the respective appliance model.

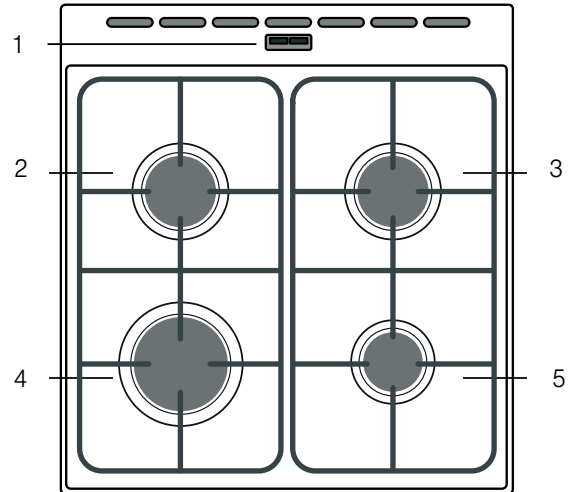

#### Explanations

1	Steam outlet <b>Caution!</b> During oven operation, hot steam escapes at this point
2	Standard burner
3	Standard burner
4	High output burner
5	Economy burner

## Control panel

Here you can see an overview of the control panel. The design depends on the respective appliance model.

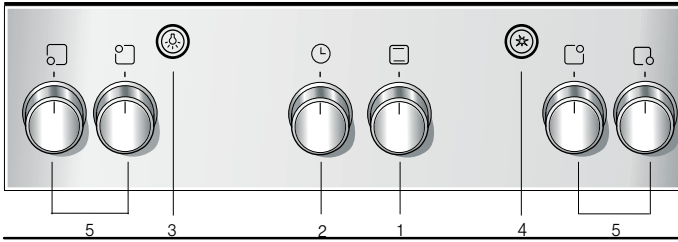

Explanatory notes	
1	Selector for the oven gas burners (function selector)
2	Timer
3	Lamp button
4	Ignition button
5	Hotplate controls

### Function selector

Turn the function selector anti-clockwise to set the oven temperature or clockwise to select the grill.

Positions	Function	
•	Zero position	Oven not hot.
170-270	Temperature range	Temperature range in °C for baking cakes in baking tins, pizza on the baking sheet, biscuits etc.
	Grill setting	Grill burner setting for grilling at maximum temperature.

Heat setting for the lower burner: 3 kW

Heat setting of the gas grill: 2,1 kW

### Timer

Using the timer, you can set a time of up to 60 minutes. The timer runs independently of the oven. It can be used like a kitchen timer.

Setting	Function	
•	Zero position	Setting off
	End of the set cooking time	Signal when the set time has elapsed
- 60	Minute display	Time display, in minutes.

### Setting procedure

Set the timer for the desired cooking time.

### The time has elapsed

When the time has elapsed, a signal sounds. The switch turns to the OFF position • automatically.

### Light button

This button switches on the oven light.

To switch it off, press the multi-function button again.

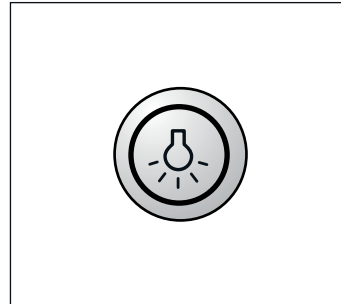

### Ignition button

This button activates the electronic ignition system.

When you press the button, all igniters ignite at the same time.

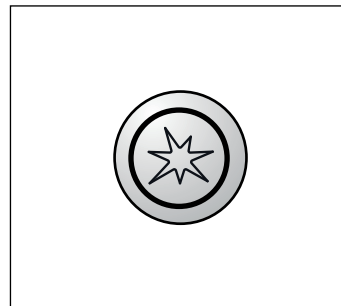

### Burner knob

You can adjust the heat setting of the hotplates using the four burner knobs.

The Positions	Function/gas oven	
	Zero position	The hotplate is switched off.
	Settings area	Large flame = highest setting Economy flame = lowest setting

There is a limit stop at the end of the settings range. Please do not turn the knob beyond this point.

## The cooking compartment

The oven light is located in the cooking compartment.

### Steam outlet

The hot air from the cooking compartment escapes at the rear of the hob. Caution: do not cover the ventilation slots. Otherwise the oven will overheat.

## Accessories

Your appliance is accompanied by a range of accessories. Here, you can find an overview of the accessories included and information on how to use them correctly.

### Accessories included

Your appliance is equipped with the following accessories:

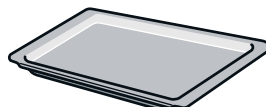
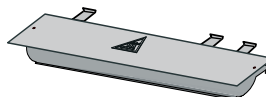
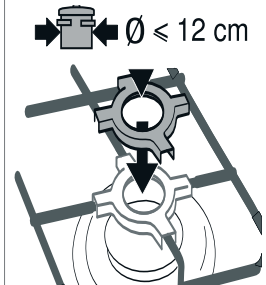
	<p><b>Wire rack</b> For ovenware, cake tins and ovenproof dishes. For roasts, grilled items and frozen meals.</p>
	<p><b>Aluminium baking tray</b> For cakes and biscuits. Slide the baking tray into the oven with the sloping edge facing the oven door. <b>Note:</b> Do not place food directly onto the aluminium baking tray. Line the aluminium baking tray with greaseproof paper.</p>
	<p><b>Protective plate</b> For use during grilling. You must use the protective plate when grilling to protect the control panel and selector against high temperatures. <b>Note:</b> The protective plate is kept in the bottom drawer or on the rear of the appliance.</p>
 <p>→ ← <math>\varnothing \leq 12 \text{ cm}</math></p>	<p><b>Coffee pot trivet for the economy burner</b> Please use the supplied coffee pot trivet for the economy burner when making Turkish coffee using pans that have a base less than 12 cm in diameter or coffee pots. Place the coffee pot trivet on the economy burner's pan support. Do not use the coffee pot trivet with pans with a base that is more than 12 cm in diameter. The coffee pot trivet is suitable for the economy burner only.</p>

Only use original accessories. They are specially adapted for your appliance.

You can buy accessories from the after-sales service, from specialist retailers or online.

**Note:** The accessories may deform when they become hot. This does not affect their function. Once they have cooled down again, they regain their original shape.

### Inserting accessories

The cooking compartment has five shelf positions. The shelf positions are counted from the bottom up.

In some appliances, the highest shelf position is marked on the cooking compartment by the grill symbol.

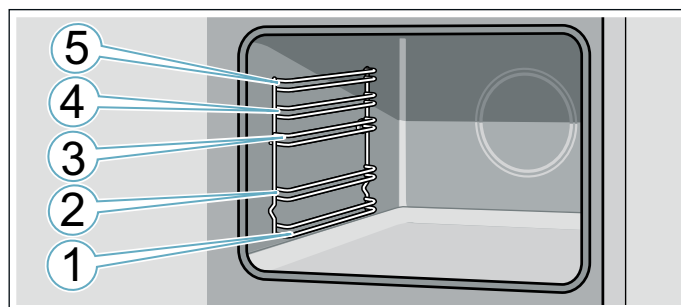

Always insert accessories between the two guide rods for the shelf position.

Accessories can be pulled out approximately halfway without tipping.

When sliding accessories into the cooking compartment, ensure that the kink in the side rail is at the back. Only then will they lock in place.

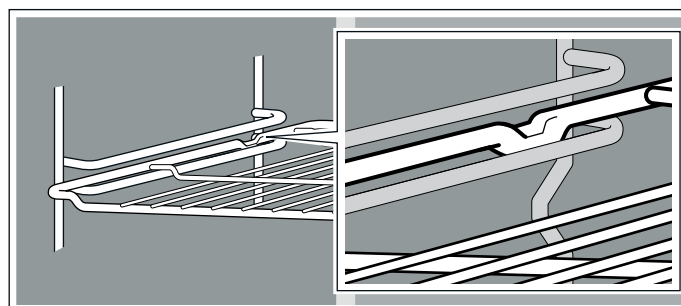

### Notes

- Hold the baking tray securely at the sides with both hands and slide it into the shelf supports, keeping it parallel. Do not move the baking tray from side to side as you slide it in, otherwise it will not go in easily and the enamelled surfaces may be damaged.
- Make sure that you always insert the accessories into the cooking compartment the right way round.
- Always insert the accessories fully into the cooking compartment so that they do not touch the appliance door.
- Take any accessories that you will not be using out of the cooking compartment.

### Optional accessories

You can buy optional accessories from our after-sales service, from specialist retailers or online. You will find a comprehensive range of products for your appliance in our brochures and online.

Their availability and whether it is possible to order them online varies from country to country. See your sales brochures for more details.

**Note:** Not all optional accessories are suitable for every appliance. When purchasing, always quote the exact product number (E no.) of your appliance.

→ "Customer service" on page 25

### Optional accessories

#### Wire rack

For cookware, cake tins and ovenproof dishes, and for roasts and grilled food.

#### Baking tray

For tray bakes and small baked items.

#### Universal pan

For moist cakes, baked items, frozen food and large roasts. It can be used to catch dripping fat when you are grilling directly on the wire rack.

#### Wire insert

For meat, poultry and fish. For inserting into the universal pan to catch dripping fat and meat juices.

#### Professional pan

For preparing large quantities of food. Also ideal for moussaka, for example.

#### Lid for the professional pan

The lid turns the professional pan into a professional roasting dish.

#### Pizza tray

For pizzas and large round cakes.

#### Grill tray

Use for grilling in place of the wire rack or as a splatter guard. Use in the universal pan only.

#### Baking stone

For home-made bread, bread rolls and pizzas that you wish to have a crispy base. The baking stone must be preheated to the recommended temperature.

#### Glass roasting dish

For stews and bakes.

#### Glass pan

For bakes, vegetable dishes and baked items.

#### Pull-out system, one level

Fitting pull-out rails at position 2 will allow you to pull accessories out further without them tipping.

#### Pull-out system, two levels

Fitting pull-out rails at positions 2 and 3 will allow you to pull accessories out further without them tipping.

#### Pull-out system, three levels

Fitting pull-out rails at positions 1, 2 and 3 will allow you to pull accessories out further without them tipping.

## Before using for the first time

Before you can use your new appliance, you must make some settings. You must also clean the cooking compartment and accessories.

### Heating up the oven

To remove the new cooker smell, heat up the oven when it is empty and closed. Ensure that no packaging material has been left in the cooking compartment.

Keep the kitchen ventilated the whole time the oven is on.

### Setting the oven's lower gas burner

1. Open the top cover, if available. Keep the top cover open for as long as the appliance is in operation.
2. Turn on the main gas supply to the appliance. Insert the plug into the socket. Open the oven door.
3. Press the function selector and turn it anti-clockwise to 270 °C.
4. Keep the function selector pressed in and press the ignition button  at the same time.

Use the igniter to ignite the gas that escapes from the lower oven gas burner.

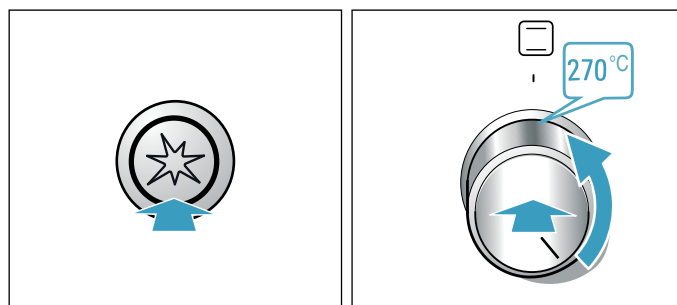

Keep the function selector pushed in for 10 seconds so that the safety pilot starts up.

5. Check through the opening in the oven's bottom panel that the flame is burning. If the flame goes out again, repeat the process from step 3.
6. Close the oven door carefully.
7. Switch off the function selector after 30 minutes.



Do not press the selector for longer than 15 seconds. If the burner does not ignite within 15 seconds, wait at least one minute before repeating the procedure.

In the event of the burner flames being accidentally extinguished, turn off the burner control and do not attempt to re-ignite the burner for at least one minute.

## Setting the gas grill on the oven

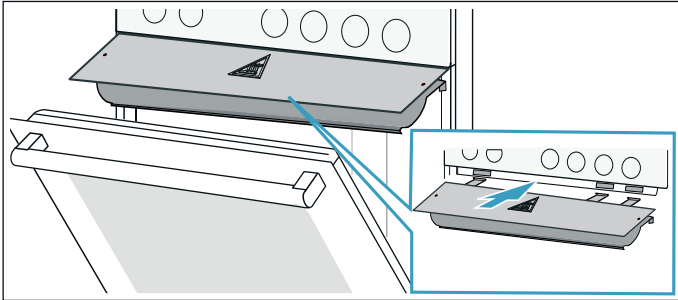
1. Open the top cover, if available. Keep the top cover open for as long as the appliance is in operation.
2. Turn on the main gas supply to the appliance. Insert the plug into the socket. Open the oven door.
3. Insert the three lugs on the protecting plate into the three notches below the control panel. Insert the protecting plate with the symbol in such a way that the lugs lie completely in the notches.



4. Close the oven door so that it is as close as possible to the protecting place.
5. Push in the function selector and turn it clockwise to the grill setting .
6. Keep the function selector pressed in and press the ignition button  at the same time.

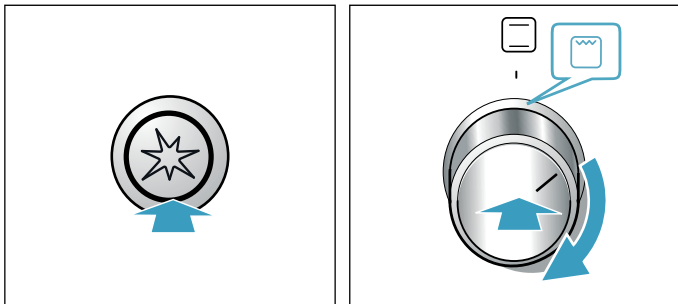

Keep the function selector pushed in for 10 seconds so that the safety pilot starts up.

7. Check whether the flame continues to light up. If the flame goes out again, repeat the process from step 5.
8. Switch off the function selector after 30 minutes. Once the oven has cooled down, remove the protecting plate.

### Caution!

The gas grill only works when the protecting plate is inserted. Make sure that the protecting plate is correctly inserted.

Do not press the selector for longer than 15 seconds. If the burner does not ignite within 15 seconds, wait at least one minute before repeating the procedure.

In the event of the burner flames being accidentally extinguished, turn off the burner control and do not attempt to re-ignite the burner for at least one minute.

## Cleaning the accessories

Before you use the accessories for the first time, clean them thoroughly with hot soapy water and a soft dish cloth.

## Cooking pans

Burner	Power [kW]	Minimum cookware diameter	Maximum cookware diameter
Electric hotplate*			
Electric hotplate*	1 kW	14.5 cm	14.5 cm
Wok burner*	3.5 kW	24 cm	28 cm
High-output burner*	3 kW	24 cm	28 cm
Standard-output burner	1.7 kW	18 cm	24 cm
Economy burner	1 kW	12 cm	18 cm

\* Optional  
Available for some appliances. Depending on the appliance model.

### Precautions for use

The following advice is intended to help you save energy and prevent pan damage:

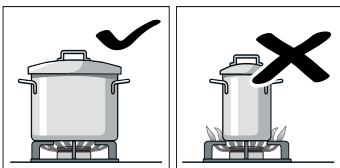

Use pans which are the right size for each burner. Do not use small pans on large burners. The flame must not touch the sides of the pan.

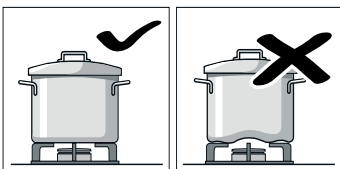

Do not use damaged pans, which do not sit evenly on the hob. Pans may tip over. Only use pans with a thick, flat base.

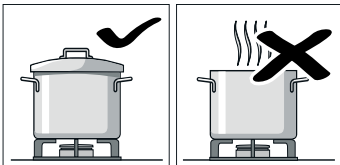

Do not cook without using a lid and make sure the lid is properly fitted. This wastes energy.

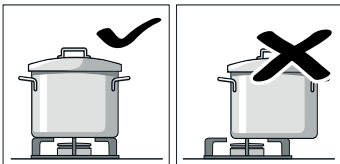

Always place the ovenware centrally over the burner. Otherwise, there is a risk that it may tip over.

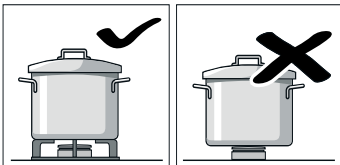

Place the pans on the pan supports, never directly on the burner. Make sure that the pan supports and burner caps are correctly positioned before using the appliance. Pans should be placed on the hob carefully. Do not strike the hob and do not place excessive weight on it.

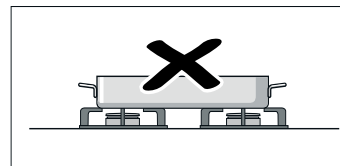
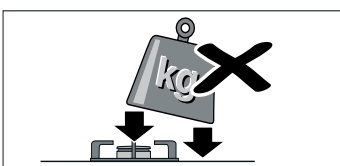

Never use two burners or heat sources to heat one single pan. Do not use grill pans, earthenware casserole dishes, etc. for a long period of time on maximum power.



## Gas burners

This chapter explains how to set a hotplate. The table shows heat settings and cooking times for various meals.

### Advance cleaning of burner cup and cap

Clean the burner cap (1) and cup (2) with water and washing-up liquid. Dry the individual parts carefully.

Place the burner cup and cap back on the burner shell (5). Ensure that the igniter (3) and flame safety pin (4) are not damaged.

The nozzle (6) must be dry and clean. Always position the burner cap exactly over the burner cup.

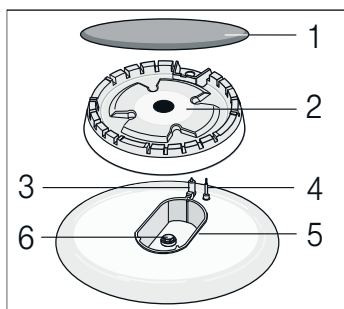



### Igniting the gas burners

Always position the burner lid precisely on the burner cup. The openings in the burner cup must remain unobstructed at all times. All parts must be dry.

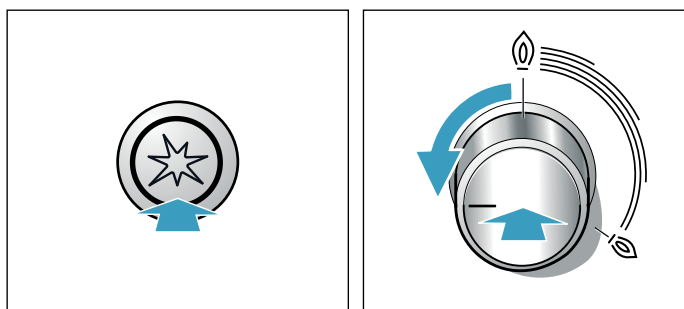
1. Open the top cooker cover. The top cover must remain open for as long as the hob is in operation.
2. Turn the hotplate control for the required hotplate anti-clockwise to the symbol with the large flame .
3. With the hotplate control pressed in, press the ignition button. Gas begins to flow out and the gas burner ignites.



4. Press and hold the burner knob for 1-3 seconds. This activates the safety pilot. If the gas flame goes out, the gas supply is automatically shut off by the flame failure device.
5. Set the desired flame size. Between the • Off position and the  position, the flame is not stable. Therefore, always choose a position between the  large flame and  small flame.
6. Check whether the flame is lit. If it is not, repeat the process from step 2.
7. To end the cooking process, turn the hotplate control clockwise to the • Off position.

The hotplate control should not be actuated for longer than 15 seconds. If the burner does not ignite within 15 seconds, wait at least 1 minute before repeating the procedure.

### The gas burner does not ignite

If there is a power cut or if the ignition plugs are damp, you can light the gas burners with a gas lighter or a match.

### Warnings

It is normal to hear a soft whistling noise while the burner is operating.

When first used, it is normal for the burner to give off odours. This does not pose any risk and does not indicate a malfunction. They will disappear in time.

An orange-coloured flame is normal. This is caused by the presence of dust in the atmosphere, spilt liquids, etc.

In the event of the burner flames being accidentally extinguished, turn off the burner control and do not attempt to re-ignite the burner for at least one minute.

A few seconds after the burner is switched off, a sound (thud) will be produced. This is not a fault - this means that the safety device is no longer operating.

Keep the burner as clean as possible. If the ignition sparkers are dirty they will not light properly. Clean them periodically using a small non-wire brush. Bear in mind that the ignition sparkers must not suffer any serious impacts.

### Table - Cooking

Select the right saucepan size for each burner. The diameter of the saucepan or pan base should be the same as that of the burner.

Cooking times may vary depending on the type of food, its weight and quality. Because of possible variations, it is best to judge the optimal cooking time yourself.

Use as little water as possible when cooking, so that the food retains its vitamins and minerals. Select short cooking times so that the vegetables remain firm and full of nutrients.

Example	Food	Hotplate	Cooking mode
<b>Melting</b>	Chocolate, butter, margarine	Economy burner	Small flame
<b>Warming</b>	Stock, tinned vegetables	Standard-output burner	Small flame
<b>Heating and keeping warm</b>	Soups	Economy burner	Small flame
<b>Steaming*</b>	Fish	Standard-output burner	Between large and small flame
<b>Braising*</b>	Potatoes and miscellaneous vegetables, meat	Standard-output burner	Between large and small flame
<b>Boiling*</b>	Rice, vegetables, meat dishes (with sauces)	Standard-output burner	Large flame
<b>Frying</b>	Pancakes, potatoes, schnitzel, fish fingers	High-output burner** Wok burner**	Between large and small flame

\* If you are using a saucepan with a lid, turn the flame down as soon as the food starts to boil.  
 \*\* Optional. Available for some appliances. Depending on the appliance model. (For frying on the wok burner, we recommend that you use a wok.)

## Operating the appliance

You have already learnt about the controls and how they work. Now we will explain how to set your appliance. You will learn about what happens when you switch the appliance on and off, and how to select the operating mode.

### Setting the oven's lower gas burner

When the lower gas burner is lit, you can start to bake on a baking tray when the oven door is closed.

Preheat the empty oven for 15 minutes and start baking.

Example in diagram: Baking at 170 °C.

1. Open the top cover, if available. Keep the top cover open for as long as the appliance is in operation.
2. Turn on the main gas supply to the appliance. Insert the plug into the socket. Open the oven door.
3. Push in the function selector and turn it anti-clockwise to 170 °C.
4. Keep the function selector pressed in and press the ignition button  at the same time.

Use the igniter to ignite the gas that escapes from the lower oven gas burner.

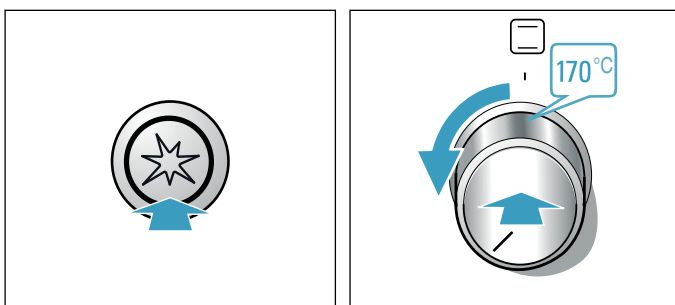

Keep the function selector pushed in for 10 seconds so that the safety pilot starts up.

5. Check through the opening in the oven's bottom panel that the flame is burning. If the flame goes out again, repeat the process from step 3.
6. Close the oven door carefully.
7. Once the food is cooked, switch off the function selector.

You can use the relevant selector to change the heating function and temperature at any time.



Do not press the selector for longer than 15 seconds. If the burner does not ignite within 15 seconds, wait at least one minute before repeating the procedure.

In the event of the burner flames being accidentally extinguished, turn off the burner control and do not attempt to re-ignite the burner for at least one minute.

## Setting the gas grill on the oven

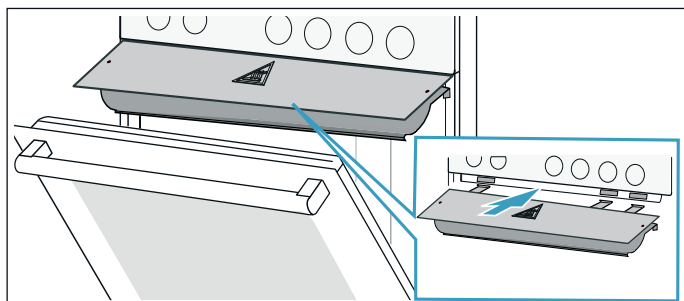
1. Open the top cover, if available. Keep the top cover open for as long as the appliance is in operation.
2. Turn on the main gas supply to the appliance. Insert the plug into the socket. Open the oven door.
3. Insert the three lugs on the protecting plate into the three notches below the control panel. Insert the protecting plate with the symbol in such a way that the lugs lie completely in the notches.



4. Close the oven door so that it is as close as possible to the protecting place.
5. Push in the function selector and turn it clockwise to the grill setting .
6. Keep the function selector pressed in and press the ignition button  at the same time.

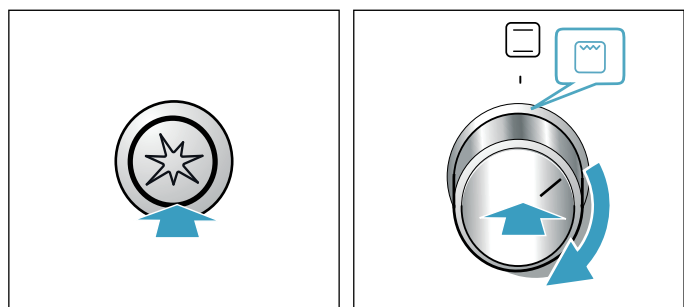

Keep the function selector pushed in for 10 seconds so that the safety pilot starts up.

7. Check whether the flame continues to light up. If the flame goes out again, repeat the process from step 5.
8. Once the food is cooked, switch off the function selector. Once the oven has cooled down, remove the protecting plate.

### Caution!

The gas grill only works when the protecting plate is inserted. Make sure that the protecting plate is correctly inserted.

Do not press the selector for longer than 15 seconds. If the burner does not ignite within 15 seconds, wait at least one minute before repeating the procedure.

In the event of the burner flames being accidentally extinguished, turn off the burner control and do not attempt to re-ignite the burner for at least one minute.

## Cleaning

With good care and cleaning, your appliance will retain its appearance and remain fully functioning for a long time to come. We will explain here how you should correctly care for and clean your appliance.

### Cleaning agents

Damage to the various different surfaces caused by using the wrong cleaning agent can be avoided by observing the following instructions.

#### When cleaning the hob do not use

- undiluted washing-up liquid or dishwasher detergent,
- scouring pads,
- abrasive cleaning agents such as oven cleaner or stain remover,
- high-pressure cleaners or steam jets.
- Do not clean individual parts in the dishwasher.

#### When cleaning the oven do not use

- sharp or abrasive cleaning agents,
- cleaning agent with a high alcohol content,
- scouring pads,
- high-pressure cleaners or steam jets.
- Do not clean individual parts in the dishwasher.

Wash new sponges thoroughly before first use.

### Warning – Risk of burns!

The appliance becomes very hot. Never touch the interior surfaces of the cooking compartment or the heating elements. Always allow the appliance to cool down. Keep children at a safe distance.

Zone	Cleaning agent
Stainless steel surfaces* (depending on appliance model)	Hot soapy water: Clean with a dish cloth and dry with a soft cloth. On stainless steel surfaces, always wipe parallel to the natural grain. Otherwise, you may scratch the surface. Remove patches and splashes of limescale, grease, starch and albumin (e.g. egg white) immediately. Corrosion can form under such patches and splashes. Special care products suitable for hot stainless steel surfaces are available from our after-sales service and from specialist retailers. Apply a thin layer of care product with a soft cloth.
Enamel, painted, plastic and screen-printed surfaces* (depending on appliance model)	Hot soapy water: Clean with a dish cloth and dry with a soft cloth. Do not use glass cleaner or glass scrapers for cleaning.
Control panel	Hot soapy water: Clean with a dish cloth and dry with a soft cloth. Do not use glass cleaner or glass scrapers for cleaning.

\* Optional (available for some appliances, depending on the appliance model)

Zone	Cleaning agent
Upper glass cover* (depending on appliance model)	Glass cleaner: Clean with a soft cloth. You can remove the upper glass cover for cleaning. To find out how to do this, please refer to the section <i>Upper glass cover</i> .
Rotary knobs Do not remove.	Hot soapy water: Clean with a dish cloth and dry with a soft cloth.
Hob surround	Hot soapy water: Do not clean with a glass scraper, lemon juice or vinegar.
Gas hob and pan supports* (depending on appliance model)	Hot soapy water. Use very little water. Water must not be allowed to enter the appliance through the base of the burners. Clean off boiled-over liquids and spilt food immediately. You can remove the pan supports. Cast iron pan supports*: Do not clean in the dishwasher.
Gas burners* (depending on appliance model)	Remove the burner head and cap and clean with hot soapy water. Do not clean in the dishwasher. The gas outlet openings must remain unobstructed at all times. Ignition plugs: Small, soft brush. The gas burners only work properly when the ignition plugs are dry. Dry all parts thoroughly. Ensure that they are refitted correctly. The burner caps are coated in black enamel. The colour may change over time. This does not impair their performance.
Electric hotplate* (depending on appliance model)	Abrasive materials or sponges: Briefly heat up the hotplate afterwards, so that it dries. Hotplates can rust over time if they remain wet. Apply care product to finish. Clean off boiled-over liquids and spilt food immediately.
Hotplate ring* (depending on appliance model)	Remove yellow to blue iridescent discoloration from the hotplate ring with a steel care product. Do not use any abrasive materials that may scratch surfaces.
Ceramic hob* (depending on appliance model)	Care: Protective/care products for ceramics Cleaning: Cleaning agents suitable for ceramics. Follow the cleaning instructions on the packaging. <b>⚠</b> Glass scraper for stubborn dirt: Remove the protective cover and clean using the blade only. Caution: The blade is very sharp. Risk of injury. Cover the blade again after cleaning. Replace damaged blades immediately.

\* Optional (available for some appliances, depending on the appliance model)

Zone	Cleaning agent
Glass hob* (depending on appliance model)	Care: Protective/care products for glass Cleaning: Cleaning agents for glass. Follow the cleaning instructions on the packaging. <b>⚠</b> Glass scraper for stubborn dirt: Remove the protective cover and clean using the blade only. Caution: The blade is very sharp. Risk of injury. Cover the blade again after cleaning. Replace damaged blades immediately.
Glass panel	Glass cleaner: Clean with a soft cloth. Do not use the glass scraper. The door can be removed to facilitate cleaning. To find out how to do this, please refer to the section <i>Removing and refitting the oven door</i> .
Childproof lock* (depending on appliance model)	Hot soapy water: Clean with a dish cloth. If a childproof lock has been fitted to the oven door, it must be removed before cleaning. If it is very dirty, the childproof lock will not work properly.
Seal Do not remove.	Hot soapy water: Clean with a dish cloth. Do not scour.
Cooking zone	Hot soapy water or a vinegar solution: Clean with a dish cloth. For stubborn dirt, use a stainless steel scouring pad or oven cleaner. Only use when the cooking compartment is cold. <b>⚠</b> Please use the self-cleaning function to clean self-cleaning surfaces. To find out how to do this, please refer to the section <i>Self-cleaning</i> . Caution! Never use oven cleaner on self-cleaning surfaces.
Glass cover for the oven light	Hot soapy water: Clean with a dish cloth.
Shelf	Hot soapy water: Clean with a dish cloth or a brush. You can remove the shelves for cleaning. To find out how to do this, please refer to the section <i>Removing and refitting shelves</i> . Telescoping extension rails* (depending on appliance model) Hot soapy water: Clean with a dish cloth or a brush. Do not remove the lubricant from the extension rails. It is best to clean them when they are pushed in. Do not soak, clean in the dishwasher, or clean in the oven as part of the self-cleaning programme. This may damage the shelves and they may no longer work properly as a result.

\* Optional (available for some appliances, depending on the appliance model)

Zone	Cleaning agent
Accessories	Hot soapy water: Soak and then clean with a dish cloth or a brush. Enamelled accessories are dishwasher-suitable.
	Aluminium baking tray*: (depending on appliance model) Dry with a soft cloth. Do not clean in the dishwasher. Never use oven cleaner. To prevent scratches, never touch the metal surfaces with a knife or a similar sharp object. Harsh cleaning products, scratchy sponges and rough cleaning cloths are not suitable. Otherwise, you may scratch the surface.
	Rotary spit* (depending on appliance model) Hot soapy water: Clean with a dish cloth or a brush. Do not clean in the dishwasher.
	Meat thermometer* (depending on appliance model) Hot soapy water: Clean with a dish cloth or a brush. Do not clean in the dishwasher.
Plinth drawer* (depending on appliance model)	Hot soapy water: Clean with a dish cloth.
* Optional (available for some appliances, depending on the appliance model)	

### Notes

- Slight differences in colour on the front of the appliance are caused by the use of different materials, such as glass, plastic and metal.
- Shadows on the door panels, which look like streaks, are caused by reflections made by the interior lighting.
- Enamel is baked on at very high temperatures. This can cause some slight colour variation. This is normal and does not affect operation.  
The edges of thin trays cannot be completely enamelled. As a result, these edges can be rough. This does not impair the anti-corrosion protection.

## Keeping the appliance clean

Always keep the appliance clean and remove dirt immediately so that stubborn deposits of dirt do not build up.

### **Warning – Risk of fire!**

Loose food remnants, fat and meat juices may catch fire. Before using the appliance, remove the worst of the food remnants from the cooking compartment, heating elements and accessories.

### Tips

- Clean the cooking compartment after each use. This will ensure that dirt cannot be baked on.
- Always remove flecks of limescale, grease, starch and albumin (e.g. egg white) immediately.
- Use the universal pan for baking very moist cakes.
- Use suitable ovenware for roasting, e.g. a roasting dish.

## Rails

With good care and cleaning, your appliance will retain its appearance and remain fully functional for a long time to come. This will tell you how to remove the shelves and clean them.

### Detaching and refitting the rails

The rails can be removed for cleaning. The oven must have cooled down.

#### Unhooking the rails

1. Hold the shelf frames from underneath and pull slightly forward. Pull the extension pins at the bottom of the rails out of the mounting holes (Fig. A).
2. Then fold the rails upwards and carefully remove them (Fig. B).

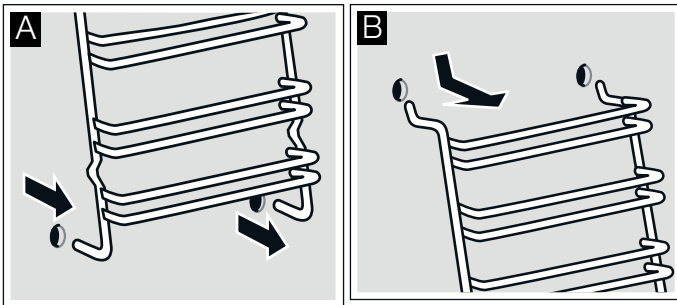

Clean the rails with washing-up liquid and a sponge. For stubborn deposits of dirt, use a brush.

#### Installing the frames

1. Insert the two hooks carefully into the upper holes. (Figure A-B)

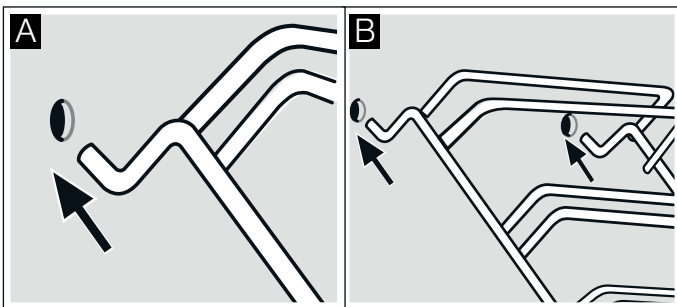

#### Warning

##### Incorrect assembly!

Never move the frame before the two hooks are fully anchored in the upper holes. The enamel could be damaged and may break (figure C).

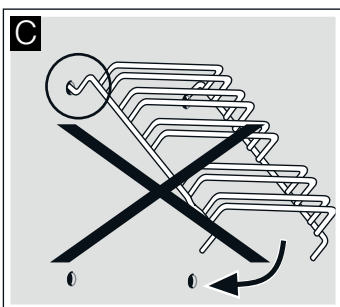

2. the two hooks must be inserted fully into the upper holes. Now move the frame slowly and carefully downwards and insert in the lower holes (figure D).
3. Insert both frames into the side walls of the oven (figure E).

If the rails are fitted correctly, the distance between the two upper shelf positions is greater.

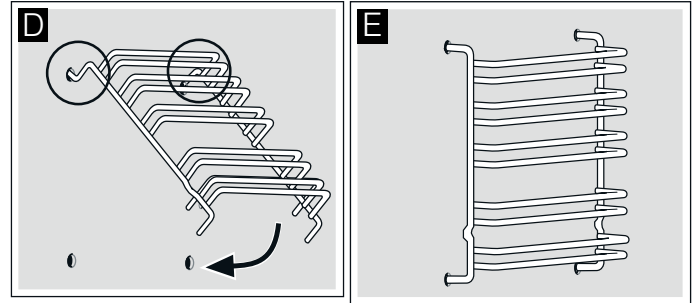

## Appliance door

With good care and cleaning, your appliance will retain its appearance and remain fully functional for a long time to come. This will tell you how to remove the appliance door and clean it.

### Detaching and attaching the oven door

For cleaning purposes and to remove the door panels, you can detach the oven door.

The oven door hinges each have a locking lever. When the locking levers are closed (figure A), the oven door is secured in place. It cannot be detached. When the locking levers are open in order to detach the oven door (figure B), the hinges are locked. They cannot snap shut.

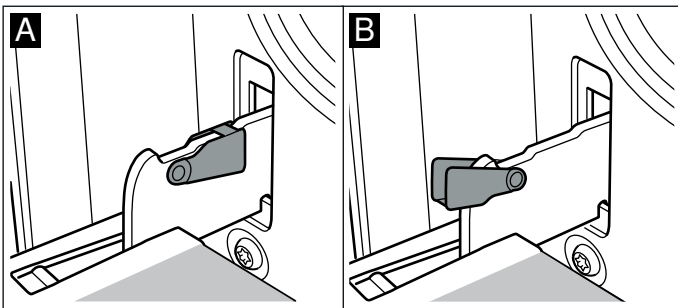

#### **⚠ Warning – Risk of injury!**

Whenever the hinges are not locked, they snap shut with great force. Ensure that the locking levers are always fully closed or, when detaching the oven door, fully open.

#### Detaching the door

1. Open the oven door fully.
2. Fold up the two locking levers on the left and right (figure A).
3. Close the oven door as far as the limit stop. With both hands, grip the door on the left and right-hand sides. Close the door a little further and pull it out (figure B).

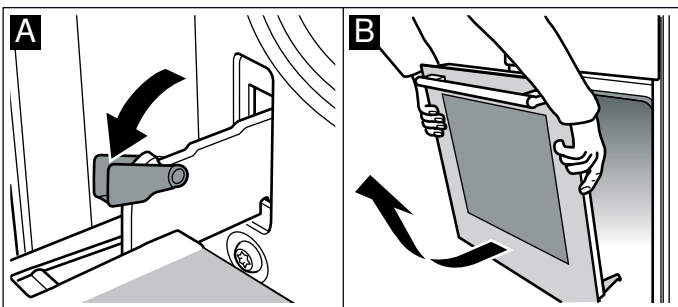

#### Attaching the door

Reattach the oven door in the reverse sequence to removal.

1. When attaching the oven door, ensure that both hinges are inserted straight into the opening (figure A).
2. The notch on the hinge must engage on both sides (figure B).

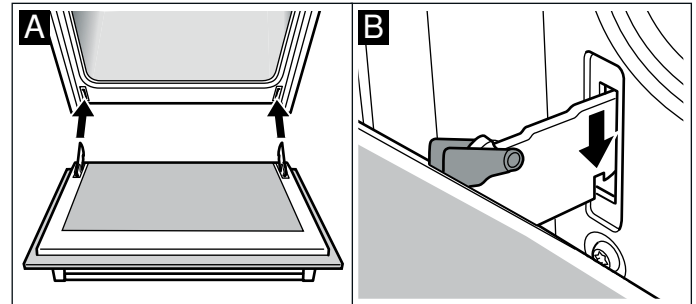

3. Fold back both locking levers (figure C). Close the oven door.

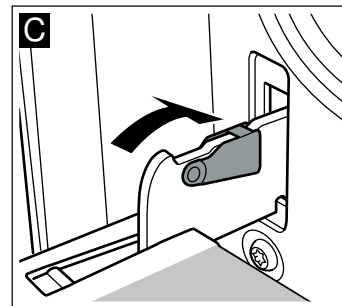

#### **⚠ Warning – Risk of injury!**

Risk of injury. If the oven door falls out accidentally or a hinge snaps shut, do not reach into the hinge. Call the after-sales service.

#### Additional door safety

When preparing meals with long cooking times, the oven door can reach very high temperatures.

Supervise small children and keep them away from the oven when the oven is in operation.

Additional safety devices have been fitted to prevent contact with the oven door. Always attach these safety devices when children could come near the oven.

You can purchase this optional accessory (11023590) from the after-sales service.

## Trouble shooting

If a fault occurs, there is often a simple explanation. Before calling the after-sales service, please refer to the fault table and attempt to correct the fault yourself.

### Fault table

If a dish does not turn out as well as you had hoped, refer to the chapter: *Tested for you in our cooking studio*. It contains useful tips and information on cooking, baking and roasting.

#### **Warning – Risk of electric shock!**

Incorrect repairs are dangerous. Repairs may only be carried out by one of our trained after-sales engineers.

Fault	Possible cause	Troubleshooting/information
The oven does not work.	Faulty circuit breaker	Look in the fuse box and check that the circuit breaker is in working order.
	Power cut.	Check whether the kitchen light or other kitchen appliances are working.
Oven not hot.	Dust on the contacts.	Turn the control knobs clockwise and anti-clockwise a few times.
The burner does not ignite.	Power cut or damp ignition plugs.	Light the gas burner with a gas lighter or a match.
The gas grill does not work.	The protecting plate is incorrectly inserted.	Make sure that the protecting plate is correctly inserted. Remove the protecting plate and reinsert it.

### Replacing the bulb in the oven ceiling light

If the bulb in the oven light fails, it must be replaced. Heat-resistant, 25 watt spare bulbs can be obtained from our after-sales service or a specialist retailer. Only use these bulbs.

#### **Warning – Risk of electric shock!**

Switch off the circuit breaker in the fuse box.

1. Place a tea towel in the cold oven to prevent damage.
2. Unscrew the glass cover by turning it anti-clockwise.

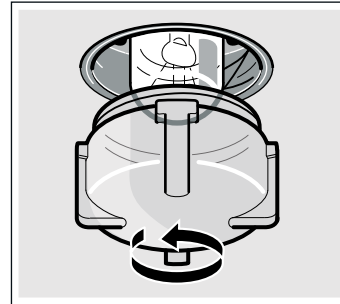

3. Replace the bulb with one of the same type.
4. Screw the glass cover back in.
5. Remove the tea towel and switch on the circuit breaker.

### Glass cover

You must replace a damaged glass cover. Suitable glass covers may be obtained from the after-sales service. Please specify the E number and FD number of your appliance.



## Customer service

Our after-sales service is there for you if your appliance needs to be repaired. We will always find an appropriate solution, also in order to avoid after-sales personnel having to make unnecessary visits.

### E number and FD number

When calling us, please give the product number (E no.) and the production number (FD no.) so that we can provide you with the correct advice. The rating plate containing these numbers is found on the side of the oven door. To save time, you can make a note of the number of your appliance and the telephone number of the after-sales service in the space below, should it be required.

<b>E no.</b>		<b>FD no.</b>	
<b>After-sales service</b> 			

Please note that there will be a fee for a visit by a service technician in the event of a malfunction, even during the warranty period.

Please find the contact data of all countries in the enclosed customer service list.

### To book an engineer visit and product advice

**GB** 0344 892 8979  
Calls charged at local or mobile rate.

**IE** 01450 2655  
0.03 € per minute at peak. Off peak 0.0088 € per minute.

Rely on the professionalism of the manufacturer. You can therefore be sure that the repair is carried out by trained service technicians who carry original spare parts for your appliances.

## Tested for you in our cooking studio

Here, you can find a selection of dishes and the ideal settings for them. We will show you which type of heating and temperature are best suited to your dish. You will get information on suitable cooking accessories and the height at which they should be placed in the oven. You will also get tips about cookware and preparation methods.

### Notes

- The values in the table always apply to dishes placed into the cooking compartment when it is cold and empty.  
Only preheat the appliance if the table specifies that you should do so. Line the accessories with greaseproof paper before preheating the appliance.
- The times specified in the tables are intended as a guide only. These values depend on the quality and composition of the food.
- Use the accessories provided. You can purchase other accessories from after-sales service or specialist retailers.  
Remove any unnecessary accessories and ovenware from the cooking compartment.  
Do not place food directly onto the aluminium baking tray. Line the aluminium baking tray with greaseproof paper.
- Always use oven gloves when taking hot accessories or ovenware out of the cooking compartment.
- Your oven can be used to bake on one level.

### Caution!

The appliance was manufactured in accordance with the reference gases specified in the standards. If a gas is used which does not comply with the specified gas mixture and pressure, cooking performance and heat output may not produce the desired result.

Gas designation	Gas mixture (%)
G20	CH <sub>4</sub> =100
G25	CH <sub>4</sub> =86, N <sub>2</sub> =14
G30	n-C <sub>4</sub> H <sub>10</sub> =50, i-C <sub>4</sub> H <sub>10</sub> =50

**Note:** A lot of steam can build up in the cooking compartment when cooking food. Your appliance is very energy-efficient and radiates very little heat to its surroundings during operation. Due to the high difference in temperature between the appliance interior and the external parts of the appliance, condensation may build up on the door, control panel or adjacent kitchen cabinet panels. This is a normal physical phenomenon. Condensation can be reduced by preheating the oven or opening the door carefully.

## Cakes and pastries

### Cake tins

When you are baking in the cake tin, insert the wire rack at the level indicated and place the cake tin on the wire rack.

Dark-coloured cake tins are the most suitable.

If you use light-coloured baking tins or glass, the baking time increases and the cake is not browned evenly.

Only use heat-resistant glass dishes. Do not place a hot glass dish on a cold or wet surface. The glass could break.

If you want to use silicone moulds, follow the guidelines in the manufacturer's instruction manual. Silicone

moulds turn out slightly smaller than normal cake tins. For this reason, the quantities may be slightly different to those indicated in your recipe.

### Baking tables for the lower burner in the gas oven

In the tables, you will find the optimum types of heating for a selection of cakes and gateaux. The temperature and cooking times depend on the quantity and consistency of the dough.

The values in the table apply to dishes placed into the cooking compartment when it is cold and empty.

The heat is distributed in the oven as soon as the gas escaping from the lower gas burner is ignited. For this reason, the underside of food is usually more browned than the top.

Cake in a mould	Accessories	Level	Temperature in °C (lower gas burner on the oven)	Cooking time in minutes
Cakes	Round springform cake tin with tube sheet, deep	2	180	60-80
Cakes	Round springform cake tin with tube sheet, wide	3	180	60-80
Sponge cake	Springform cake tin (dia. 26 cm)	2	180	50-60
Apple pie	Springform cake tin, light (dia. 20 cm)	2	230	60-80
Semolina cake	Glass ovenproof dish, rectangular	3	180	60-80

Several small baked items on the baking sheet	Accessories	Level	Temperature in °C (lower gas burner on the oven)	Cooking time in minutes
Small cakes	Baking sheet	4	170	70-90
Biscuits	Baking sheet	3	180	40-60
Sesame seed rings	Baking sheet	4	190	60-80
Puff pastry strudel	Baking sheet	4	180	50-70
Yufka dough strudel	Baking sheet	3	190	60-80
Yeast-risen pastry	Baking sheet	4	170	70-90
Pizza	Baking sheet	3	190	50-70

Dish	Accessories and ovenware	Level	Temperature in °C	Cooking time in minutes
Pasta bake	Glass ovenproof dish, rectangular*	2	190	60-80
Potato gratin made using raw ingredients, Max. 4 cm deep	Glass ovenproof dish, rectangular*	2	180	60-80
Vegetable goulash	Earthenware pot	2	220	80-100

\* Only use heat-resistant glass dishes. Do not place a hot glass dish on a cold or wet surface. The glass could break.

### Baking tips

You wish to bake according to your own recipe.	Use similar items in the baking tables as a guide.
How to tell whether sponge cake is baked through:	Approx. 10 minutes before the end of the baking time stated in the recipe, insert a cocktail stick into the cake at its deepest point. If the cocktail stick comes out clean, the cake is ready.
The cake collapses.	Next time, add less liquid. Observe the specified mixing times in the recipe.
The cake has risen in the middle but is lower around the edge.	Do not grease the edge of the springform cake tin. After baking, loosen the cake carefully with a knife.

The cake is too dry.	Make tiny holes in the finished cake using a cocktail stick. Then drizzle fruit juice or an alcoholic drink over it. Next time, reduce the baking time.
The bottom of a fruit cake is too light.	Place the cake one level lower the next time.
The fruit juice overflows.	Next time, use the deeper universal pan (if available).
The pieces of dough are sticking together when the yeast rolls are baked.	There must be a distance of about 2 cm between the bread rolls. This gives enough space for the bread rolls to expand and bake evenly on all sides.
Condensation forms when you bake moist cakes.	Steam can form during baking, which escapes via the door. The steam may settle and form water droplets on the control panel or on the fronts of adjacent units. This is a natural process.

## Meat, poultry, fish, toast









### Table - cooking - gas grill

The values in the table apply to dishes placed in a cold oven.

Turn the pieces of meat after  $\frac{2}{3}$  of the cooking time.

Always place items in the centre of the wire rack.

If you are grilling directly on the wire rack, you should insert the baking tray at level 1. The fish juices are collected in the pan and the oven is kept cleaner.

Dish	Weight	Accessories and oven-ware	Level	Type of heating	Cooking time in minutes
<b>Meat</b>					
Steaks, (2 pieces, 3 cm thick)	0.5 kg	Wire rack	4		30-40
Hamburgers (6 slices)	0.3 kg	Wire rack	4		10-20
Sausages (5 pieces)	0.2 kg	Wire rack	4		10-20
<b>Poultry</b>					
Chicken drumsticks (4 pieces)	1.5 kg	Wire rack	4		40-50
<b>Fish</b>					
Fish, whole (2 pieces)	1.0 kg	Wire rack	4		35-45
Fish fillets (4 pieces)	0.5 kg	Wire rack	4		35-45
<b>Toast</b>					
Toasts, browned (4 slices)	-	Wire rack	4		2-4
Toasts with filling, browned from above (4 slices)	-	Wire rack	4		3-5

## Tips for roasting and grilling

The table does not contain information for the weight of the joint.	Select the next lowest weight from the instructions and extend the time.
How to tell when the roast is ready.	Use a meat thermometer (available from specialist shops) or carry out a "spoon test". Press down on the roast with a spoon. If it feels firm, it is ready. If the spoon can be pressed in, it needs to be cooked for a little longer.
The roast is too dark and the crackling is partly burnt.	Check the shelf height and temperature.
The roast looks good but the juices are burnt.	Next time, use a smaller roasting dish or add more liquid.
The roast looks good but the juices are too clear and watery.	Next time, use a larger roasting dish and use less liquid.
Steam rises from the roast when basted.	This is normal and due to the laws of physics. The majority of the steam escapes through the steam outlet. It may settle and form condensation on the cooler switch panel or on the fronts of adjacent units.

## Yoghurt

You can use your appliance to make yoghurt.

Remove the accessories and shelf supports from the cooking compartment. The cooking compartment must be empty.

1. Heat 1 litre of 3.5% fat milk to 90 °C on the hob and then leave it to cool down to 40 °C.  
Only heat UHT milk to 40 °C.
2. Stir in 30 g (approx. 1 tbsp) of (chilled) yoghurt.

3. Pour the mixture into cups or small jars with lids and cover.
4. Place the cups or jars on the cooking compartment floor.
5. Press the multi-function button/lamp button .
6. Close the oven door and wait for 4-5 hours until the yoghurt is ready.
7. Once the yoghurt is ready, leave it to cool in the refrigerator.

Meal	Accessories/cookware	Shelf position	Setting	Temperature in °C	Preparation time
Yoghurt	Cup/jar	Cooking compartment floor		-	4-5h

## Acrylamide in foodstuffs

Acrylamide is mainly produced in grain and potato products heated at high temperatures, such as potato

crisps, chips, toast, rolls, bread, baked goods made from shortcrust pastry (biscuits, gingerbread, cookies).

Recommendations for baking, roasting and grilling with low acrylamide values	
<b>General</b>	<ul style="list-style-type: none"> <li>■ Keep cooking times to a minimum.</li> <li>■ Cook the food until it is golden brown. "Browned, not charred".</li> <li>■ The larger and thicker the food, the less acrylamide it contains.</li> </ul>
Oven chips	Where possible, spread out a single layer of oven chips evenly on the baking tray. To prevent the chips from trying out quickly, cook at least 400 g on the baking tray.









## Thank you for buying a Bosch Home Appliance!

Register your new device on MyBosch now and profit directly from:

- **Expert tips & tricks for your appliance**
- **Warranty extension options**
- **Discounts for accessories & spare-parts**
- **Digital manual and all appliance data at hand**
- **Easy access to Bosch Home Appliances Service**

Free and easy registration – also on mobile phones:

**[www.bosch-home.com/welcome](http://www.bosch-home.com/welcome)**



## Looking for help? You 'll find it here.

Expert advice for your Bosch home appliances, need help with problems or a repair from Bosch experts.

Find out everything about the many ways Bosch can support you:

**[www.bosch-home.com/service](http://www.bosch-home.com/service)**

**Contact data of all countries are listed in the attached service directory.**

**Robert Bosch Hausgeräte GmbH**

Carl-Wery-Straße 34

81739 München

Germany

**[www.bosch-home.com](http://www.bosch-home.com)**



9001445107

000205(C)



## Free Manuals Download Website

<http://myh66.com>

<http://usermanuals.us>

<http://www.somanuals.com>

<http://www.4manuals.cc>

<http://www.manual-lib.com>

<http://www.404manual.com>

<http://www.luxmanual.com>

<http://aubethermostatmanual.com>

Golf course search by state

<http://golfingnear.com>

Email search by domain

<http://emailbydomain.com>

Auto manuals search

<http://auto.somanuals.com>

TV manuals search

<http://tv.somanuals.com>