



Analog fire panels

FPA-1000 Family



BOSCH

en Installation and Operation Guide

Table of contents

1	Notices	6
1.1	General information	6
1.1.1	Trademarks	6
1.2	Symbols and Notes Used	6
1.3	FCC Compliance Notice	7
1.4	NFPA Standard 72	8
2	System information	9
2.1	Introduction	9
2.2	Features	11
2.3	System Overview Mainboard Components	13
2.4	Plug-in Modules	14
2.5	Power Supply	15
2.6	Components Connected to the Option Bus	16
2.7	Signaling Line Circuit Devices	17
2.8	Notification Appliance Circuit Devices	21
2.9	Communicator	21
2.10	Components and Accessories	21
2.11	Related Documents	22
3	Planning Information	23
3.1	Power Supply Calculations	23
3.2	Network Wiring/Connection Considerations	23
3.2.1	Ground Fault Detection	23
3.3	Configuration and Programming Basics	24
3.3.1	Points	24
3.3.2	Advanced Point Features and Processing	26
3.3.3	Events	29
3.3.4	Zones	31
3.3.5	Special Alarm Features	34
3.3.6	Sequential Reset	36
3.3.7	Multi-combined/multi-separated Alarm Modes	36
3.3.8	External Signaling	36
3.4	Address Assignment	36
3.4.1	Option Bus Address Assignment	37
3.4.2	SLC Address Assignment	38
3.4.3	Mainboard Address Assignment	39
3.5	Reporting Requirements	40
3.6	UL 864 Standard-specific Requirements	43
3.7	NFPA Standard-specific Requirements	45
3.8	Fire Safety Considerations	46
4	Installing	48
4.1	Installation Precautions	48
4.2	Installation Considerations for UL Listed Systems	48
4.3	FPA-1000 Fire Panel Components	49
4.4	General wiring requirements	49
4.5	Installing the Enclosure	52
4.6	Installing the Mainboard	55
4.7	Installing Optional Plug-in Modules	57
4.7.1	Mounting plug-in modules	58

4.7.2	CITY TIE module	59
4.7.3	SLC module	61
4.7.4	Network Connections	64
4.8	Control Panel Terminal Connections	66
4.9	Option Bus	67
4.10	NACS	67
4.10.1	NAC wiring	68
4.10.2	NAC specifications	68
4.10.3	Synchronicity	69
4.11	Mainboard Relays	69
4.12	Phone Line Connections (DACT)	70
4.13	Ethernet Connection	71
4.14	Power Supply Wiring	71
4.14.1	AC Power Connection	71
4.14.2	Battery Connection	73
4.14.3	Auxiliary Power Connection	76
4.14.4	External Power Supply	77
5	Monitoring, Operating, and Programming	78
5.1	Authority Level and PIN Codes	78
5.2	Panel access	79
5.3	Keypads	80
5.4	Keypad Operations	84
5.5	System Normal Displays	86
5.6	Off-normal Displays	88
5.7	Menu Navigation and Structure	90
5.7.1	Menu Structure	92
5.8	Browser Navigation and Structure	98
5.8.1	Off-site and on-site access	98
5.8.2	Working with web pages	99
5.9	Overview of the web user Interface	100
6	Diagnostics and Troubleshooting	103
6.1	Phone monitor troubleshooting	103
6.2	Diagnostics Data and System Information	103
6.3	FPE-1000-SLC LED Operation	104
6.4	Power and Battery Test	105
7	Maintaining	106
7.1	Battery Maintenance	106
7.2	Fuse Replacement	106
7.3	Network Communication Reset	107
7.4	System Reset	107
8	Specifications	108
8.1	Environmental	108
8.2	Electrical	108
8.3	Mechanical	111
8.4	Panel Address Data	113
9	Appendices	114
9.1	Abbreviations on the Control Panel Display	114
9.2	Default Programming	116
9.3	Compatible SLC Devices for Retrofit Projects	126

9.4	Reporting Codes	128
9.5	FPA-1000-UL Operating Instructions Sheet	135
9.6	FPA-1000-V2 Operating Instructions Sheet	137

1 Notices

1.1 General information

**Notice!**

Within this document, FPA-1000 refers to both the FPA-1000-UL and FPA-1000-V2. Reference to a complete identifier (FPA-100-UL or FPA-1000-V2) indicates the text applies to only that product/system.

Before using the device, read these instructions. If you do not read and understand these explanations, you will not be able to operate the device properly. For proper installation, also read and understand NFPA 72, The National Fire Alarm Code before installation.

The operating instructions do not eliminate the need for training by authorized personnel. The operating instructions area required part of the system. The instructions must be available on site and given to the new owner if the system is ever sold.

Install, test and maintain the device according to these instructions, NFPA codes, local codes, and the authority having jurisdiction (AHJ). Failure to follow these instructions can result in failure of the device to operate properly. Bosch Security Systems, Inc. is not responsible for improperly installed, tested or maintained devices.

The Installation and Operation Guide does not contain special information about local requirements and safety issues. Information on such issues is provided only to the extent that it is needed for operation of the device. Ensure that you are familiar with all safety-related processes and regulations in your area. This also includes:

- How to act in the event of an alarm
- Initial steps to take if a fire breaks out

**Notice!**

Bosch Security Systems, Inc. has tested and approved the FPA-1000 FACP's and their associated Networking cards including the system software. The system must be operated only with the software included in the product delivery or with authorized software upgrades (downloadable from the official Bosch homepage – www.boschsecurity.com). Bosch cannot be held responsible if devices are operated with any modified software or software from other sources.

1.1.1 Trademarks

All hardware/software product names used in this document are likely to be registered trademarks and must be treated accordingly.

1.2 Symbols and Notes Used

The various chapters contain only whatever safety information and notes are required for installation and operation of the system.

The following symbols are used:

**Notice!**

Contains useful information to help you operate the FPA-1000 FACP's and to avoid damages or possible dangerous situations.

**Caution!**

A hazard or unsafe practice could result in minor injury.

**Warning!**

A hazard or unsafe practice could result in severe injury or death. Follow the instructions without fail – for your own safety as well as that of the people around you.

**Danger!**

A hazard or unsafe practice will result in severe injury or death. Follow the instructions without fail – for your own safety as well as that of the people around you.

For example:

Hazardous Voltage.

Danger of contact with live parts and wires.

Disconnect and lock out power before connecting equipment or servicing!

1.3

FCC Compliance Notice

This equipment was tested and found to comply with the limits for a Class B digital device, pursuant to Part 15 of the FCC Rules. These limits are designed to provide reasonable protection against harmful interference in a residential installation. This equipment generates, uses, and can radiate radio frequency energy, and if not installed and used in accordance with the instructions, might cause harmful interference to radio communications. There is no guarantee that interference will not occur in a particular installation. If this equipment does cause harmful interference to radio or television reception, that can be determined by turning the equipment off and on, the user is encouraged to try to correct the interference by one or more of the following measures:

- Re-orient or relocate the receiving antenna.
- Increase the separation between the equipment and the receiver.
- Connect the equipment into an outlet on a circuit different from that to which the receiver is connected.
- Consult the dealer or an experienced radio or TV technician for help.

FCC Phone Connection to Users

This control panel complies with Part 68 of the FCC rules.

On the inside of the enclosure is a label that contains, among other information, the ringer equivalence number (REN) for this equipment. You must, upon request, provide this information to your local telephone company.

The REN is useful to determine the quantity of devices that can be connected to your telephone line and still have all of those devices ring when your telephone number is called. In most, but not all areas, the sum of the RENs of all devices connected to one line should not exceed five. To ascertain the number of devices that you can connect to your line, contact your local telephone company to determine the maximum REN for your local calling area. This equipment can not be used on coin service provided by the telephone company. Do not connect this control panel to party lines. If this equipment causes harm to the telephone network, the telephone company might discontinue your service temporarily. If possible, they will notify you in advance. But if advance notice isn't practical, you will be notified as soon as possible.

You will be informed of your right to file a complaint with the FCC. The telephone company might make changes in its facilities, equipment, operations, or procedures that could affect the proper functioning of your equipment. If they do, you will be notified in advance to give you an opportunity to maintain uninterrupted telephone service.

If you experience trouble with this equipment, contact the manufacturer for information on obtaining service or repairs.

The telephone company might ask that you disconnect this equipment from the network until the problem is corrected or until you are sure that the equipment is not malfunctioning. The manufacturer, not the user, must make the repairs to this equipment.

To guard against accidental disconnection, there is ample room to mount the telco jack inside of the control panel cabinet.

The operation of this control communicator might also be affected if events such as accidents or acts of God cause an interruption in telephone service.

1.4 NFPA Standard 72

NFPA 72 (the National Fire Alarm and Signaling Code for the United States) is one of the standards referenced in this manual. The current edition (2016) of this standard is available at a nominal cost from: The National Fire Protection Association, Batterymarch Park, Quincy, MA 02269.

Older editions of the standard identified circuit types by Class and Style. The newer editions use Class only. The following table identifies the relationship between the older and newer designations.

New Designations	Old Designations			
	IDC	NAC	SLC	Supplementary
Class B	Class B, Style B Class B, Style C	Class B, Style Y	Class B, Style 4	
Class A	Class A, Style D Class A, Style E	Class A, Style Z	Class A, Style 6	
Class X			Class A, Style 7	
Class E				Non-supervised

Tab. 1.1: NFPA 72 circuit designations

2 System information

2.1 Introduction

The FPA-1000 Analog Addressable Fire Panels are advanced analog addressable control panels for small to medium facilities in residential, commercial or public building applications. They are listed by UL for central station, local, auxiliary, and remote station systems.

The fire panels combine complete built-in Fire Alarm Control Panel (FACP) equipment such as Notification Appliance Circuits (NACs), Signaling Line Circuits (SLCs), relays, power supply, Digital Alarm Communicator Transmitter (DACT) and Ethernet connection with the expandability through the Option Bus or plug-in boards. Each FPA-1000 has two integrated NACs that can be expanded with addressable Remote Notification Appliance Circuit Power Supplies. These circuits can be programmed with specific activation patterns.

The standard control panel has one FPE-1000-SLC for up to 254 addressable detectors and modules, or up to 127 analog sounder bases in combination with a suitable detector. The control panel is easily expandable with a second FPE-1000-SLC doubling the address points. The panel has a compact and solid metal housing with a removable front door with keyed lock and a removable dead front door to access electronics. It features surface and semi-flush mounting options.

On the front of the panel, six light-emitting diodes (LEDs) show fire alarm, gas alarm, power, supervisory, silence and trouble conditions. The built-in keypad can be used for total system control and programming. In addition, a large 4-line by 20-character alphanumeric display shows programmed device point information. Four keys enable acknowledge, reset, silence, and drill functions.

The FPA-1000 fire panels enable various programming approaches:

- Front panel programming
- On-site programming, using a laptop with the possibility of pre-programming at the office
- Off-site programming, with remote access via Ethernet (browser-based) or phone line (PSTN)

For front panel programming, the system provides an Auto Learn function, allowing the installer to configure the system quickly and easily in default mode.

Using a local laptop or remote access through a communicator, the programming is carried out by means of browser-based user interface. Therefore, no software installation is required.

The panel can receive diagnostics from a Web browser running on a networked PC.

The FPA-1000 Analog Addressable Fire Panels comply with the relevant standards.

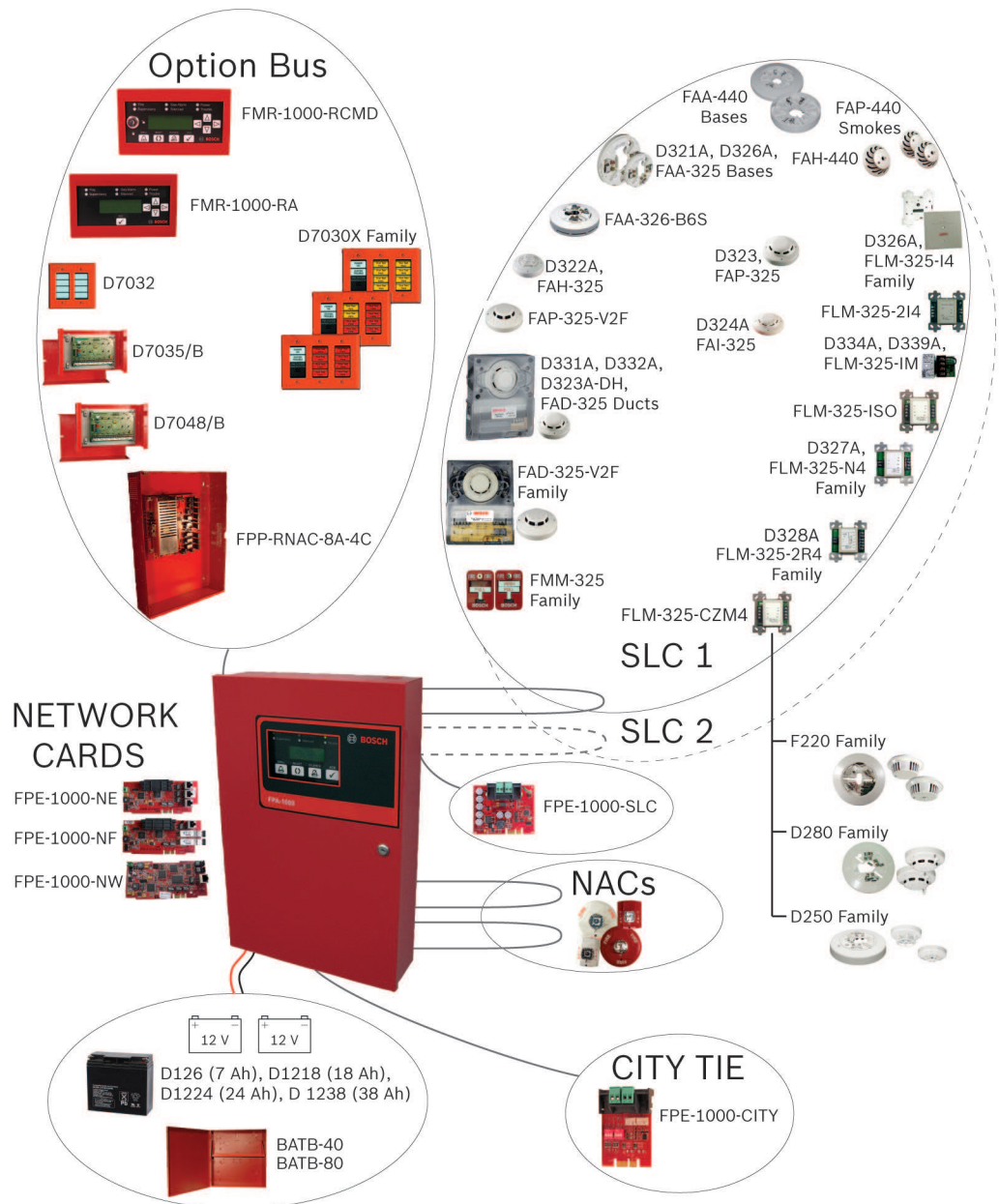

Figure 2.1: FPA-1000-V2 System architecture

Optional Networking Cards allow multiple panels to be interconnected into a networked system.

Options

The FMR-1000-RCMD Four-wire LCD annunciator has system control capability. It shows the equivalent LEDs and LCD display and includes a piezo, scrolling buttons, and operation keys for acknowledge (ACK), drill, reset and silence. The scrolling functions and the acknowledge key are accessible without restriction. The keys for reset, silence or drill can be enabled and disabled by the device key lock.

The FMR-1000-RA is an LCD annunciator without control. It shows the equivalent LEDs and LCD display. It includes a piezo sounder, scrolling buttons and acknowledge key. The scrolling functions and the acknowledge key are accessible without restriction.

The City Tie Plug-in Module FPE-1000-CITY provides the system with two supervised City Tie Local Energy circuits or Reverse Polarity circuits. The FPE-1000-CITY plugs into the FPA-1000 mainboard.

2.2

Features

System Configuration

- Basic configuration includes one analog Signaling Line Circuit (SLC), configurable as two Class B, one Class A, or one Class X circuit
- Second SLC easily expandable with FPE-1000-SLC Signaling Line Circuit
- Up to 254 detectors and modules, or up to 127 analog sounder bases in combination with a suitable detector, for a total of 254 addressable device capacity per SLC
- SLC circuits use standard wire; no shielded or twisted pair required. Twisted pair wire, CAT 5 cable, or fiber optic cable used on network connections
- Programmable sensitivity levels per device, and automatic day and night sensitivity modes
- Automatic calibration and drift compensation routine
- 120 V/240 V AC power, total 5.5 A transformer output
- Two integrated NAC circuits rated at 2.5 A each, allowing up to 4 A total current (shared between AUX power, Option Bus, and NAC)
- Up to four addressable FPP-RNAC-8A-4C Remote notification appliance circuit power supplies, providing Aux power and up to 16 synchronized remote NAC circuits
- Mainboard NAC patterns include Steady, Pulsing, Temporal Code 3, and Temporal Code 4, Wheelock, System Sensor, and Gentex
- Built-in synchronization for appliances from Wheelock, System Sensor, and Gentex
- Three programmable Form C relays on the mainboard (fire, trouble, supervisory, gas alarm or activation by zone)
- Option Bus for optional boards and expansions including LCD/LED annunciators, Octal Driver Module, Octal Relay Module, and Remote Notification Appliance Circuit Power Supply
- Optional City Tie Plug-in Module FPE-1000-CITY with two circuits, each programmable to Local Energy or Reverse Polarity
- Optional plug-in Networking Cards (three models) for connecting fire panels into a networked system
- Built-in Ethernet interface for Conettix IP reporting and/or programming and diagnostics
- Built-in dual phone line PSTN DACT communicator
- Contact ID, SIA 300 and Modem IIIA² reporting formats
- UL Listed, FM/CSFM/MEA approved

Ease of Use and Functionality

- Large 4-line by 20-character LCD display
- Six LED status indicators on each panel keypad or remote LCD annunciators, including gas alarm LED

- Menu-driven user interface on panel
- Easy programming from panel keypad
- Browser-based user interface for programming and diagnostics running on a Microsoft Windows or Unix/Linux based network operating system, no software installation is required
- Programmable authority levels, secured with a user-definable four-digit PIN
- 225 software zones for flexible input-output mapping on a non-networked panel
- 128 local zones per panel and 97 grouped zones for flexible input-output mapping on a network
- Programming option for sandwich alarm allows time-triggered phased evacuation (evacuation floor by floor)
- Auto Learn feature for easy start-up programming
- Local piezo sounder
- Fire drill test function
- Walk test function
- Alarm verification feature
- Bypass or unbyypass point, output or zone individually
- 2999 events history buffer
- Event and history printing via network printer
- Three language versions (English, Spanish, and Portuguese), software configurable, LED and keypad labeling easy exchangeable
- Programming option for IP reporting communication with the Advanced Encryption Standard (AES)

Hardware Features

- Removable front door with keyed lock
- Removable dead front door to access electronics
- Mounting kit available for semi-flush installation with trim ring
- Metal oxide varistors (MOVs) and spark gaps for protection from lightning surges and static discharges

2.3 System Overview Mainboard Components

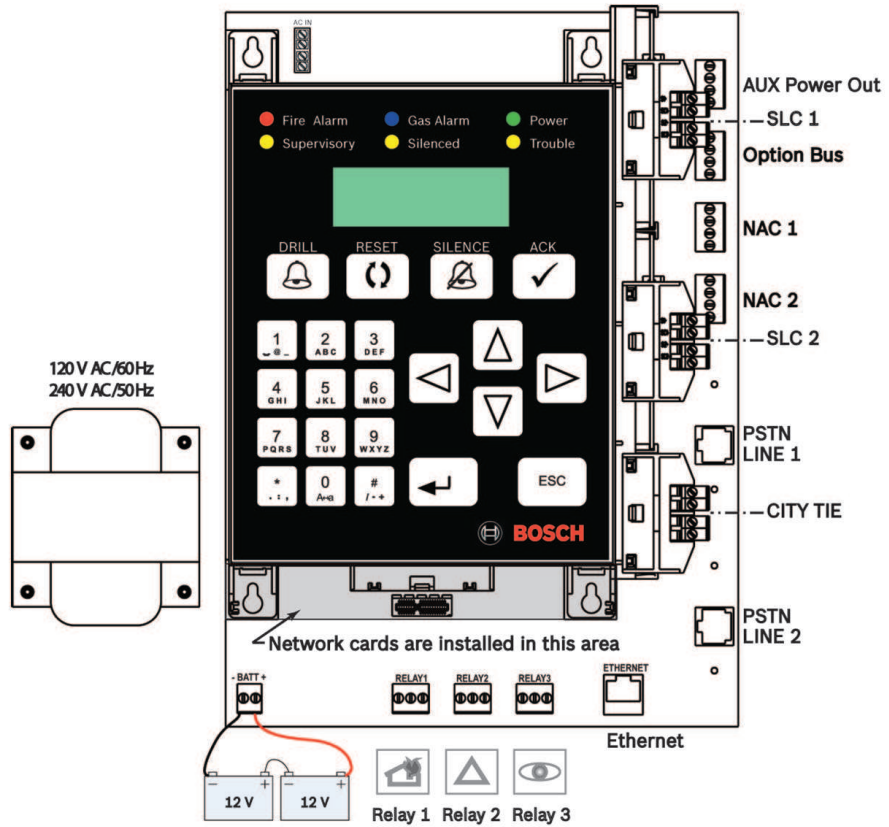

Figure 2.2: FPA-1000-V2 Mainboard

Designation	Description
Keypad	With LEDs, LCD display, and keys.
Transformer	Works with 120 V AC, 60 Hz or 240 V AC, 50 Hz.
SLC 1 / SLC 2	Signaling Line Circuit (SLC), standard configuration with one SLC, second SLC with FPE-1000-SLC Plug-in Module, Nominal 39 V DC (30 to 40 V DC), 260 mA maximum (per SLC), power-limited, supervised.
Option bus	Provides serial data interface, with 500 mA at 12 V DC, power-limited, supervised.
AUX FWR- / FWR+ RST- / RST+	Two auxiliary power supply terminals, with 500 mA at 24 V DC each, power-limited, non-supervised, FWR = Full Wave Rectified, non-switched RST = Resettable, switched and filtered.
NAC 1 / NAC 2	Terminal strips for two NACs, 2.5 A each. Wiring options Class A or Class B. For Mainboard NAC wiring example, see <i>NAC wiring</i> , page 68 (NAC 1 = Class A, NAC 2 = Class B)
CITY TIE	Slot for City Tie Plug-in Module FPE-1000-CITY

Designation	Description
Networking Card	Slot for one of three models of Networking Card
RELAY 1 RELAY 2 RELAY 3	Mainboard relays, default assignment is for alarm, trouble and supervisory; individually programmable for alarm, trouble, supervisory, gas alarm, activation by zone and system events, rated at 5 A, 30 V DC/10 A, 120 V AC.
LINE 1 / LINE 2	Phone line connections through central station receiver (2 x RJ45).
ETHERNET	Ethernet connection (RJ45).
BATT	Terminal strip for battery connection, 2 x 12 V, 18 Ah maximum within enclosure or 40 Ah maximum external.

Tab. 2.2: Mainboard (MB) components



Notice!

Network cards can only be used with an FPA-1000-V2 board, never with an FPA-1000-UL board.

The boards, expanders and devices, listed in the following sections, are available from Bosch Security Systems, Inc. to be used with the FPA-1000 fire panels. For a complete description of and installation instructions for each product, refer to the appropriate section of this manual and the documents supplied with the device.

2.4 Plug-in Modules

The following plug-in modules are available for the FPA-1000 fire panels:

Type Number	Description
FPE-1000-NE	Ethernet Networking Card
FPE-1000-NF	Fiber Optic Networking Card
FPE-1000-NW	Wired Networking Card
FPE-1000-SLC	Signaling Line Circuit (second circuit or replacement)
FPE-1000-CITY	City Tie Plug-in Module

Tab. 2.3: Plug-in modules

When a networked system of fire panels is desired, the Networking Cards provide the means to interconnect the panels.

A second SLC can easily be added by plugging in the FPE-1000-SLC to the mainboard.

The City Tie Plug-in Module FPE-1000-CITY provides two circuits which can be programmed as Local Energy or Reverse Polarity mode.

Designation	Description
M34-56	Local energy Trip, Surface Mount, Cottage Shell
M34-72	Local energy Trip, Sheet Metal Housing (less inner case test block, tap key & bell), Plain Door

Designation	Description
M34-75	Local energy Trip, Surface Mount, Cottage Shell (less inner case test block, tap key & bell)
M34-92	Local energy Trip, Flush Mount, Gasketed cast frame for interior and exterior use
M34-110	Same as M34-56 with plain door painted blue
M34-111	Same as M34-56 with plain door painted red
M34-112	Same as M34-56 with plain door painted yellow
M34-113	Same as M34-92 with plain door painted blue
M34-114	Same as M34-92 with plain door painted red
M34-115	Same as M34-75 with plain door painted blue
M34-116	Same as M34-75 with plain door painted red

Tab. 2.4: Compatible Gamewell devices for the City Tie module in Local Energy mode

2.5

Power Supply

A transformer working with 120 V AC or 240 V AC is supplied standard with the control panel. Two backup batteries with 7 Ah or 18 Ah each fit inside the fire panel cabinet. A separate battery box can provide higher capacity.

Each FPA-1000 provides two auxiliary power supplies: one 0.5 A at 24 V FWR; one 0.5 A at 24 V DC RST (resettable). This auxiliary power can run expansion boards or other low current auxiliary devices.

For a list of Bosch batteries and battery boxes, see the following table. For selecting the necessary battery capacity, use the Microsoft Excel based *FPA-1000_Battery_Calculator.xls*. The spreadsheet can be downloaded at www.boschsecurity.com.

Type Number	Description
D126	Battery 12 V, 7 Ah
D1218	Battery 12 V, 18 Ah
D1224	Battery 12 V, 24 Ah
D1238	Battery 12 V, 38 Ah
BATB-40	Battery Box - provides a single level (two-battery capacity) of battery storage with an optional shelf that increases the battery capacity to four batteries.
BATB-80	Battery Box - Includes a mounted shelf that holds up to four batteries.

Tab. 2.5: Bosch batteries and battery boxes

For installations requiring battery capacity higher than 40 Ah, a regulated and UL 1481 Listed external power supply can be used. The external power supplies connect through the panel's battery terminals. Batteries and battery charger are not supervised. For supervision of AC and battery fault use an input module (for example FLM-325-2I4) on the SLC.

2.6 Components Connected to the Option Bus

Remote Command Center and Annunciators

Each FPA-1000 panel supports up to:

- a total of eight FMR-1000-RCMD and/or FMR-1000-RA LCD annunciators
- eight D7030X Family annunciators with eight LED zones each
- eight D7030X Family/D7032 combinations

For wiring requirements, see *Option Bus*, page 67. For address restrictions, see *Option Bus Address Assignment*, page 37.

Type Number	Description
FMR-1000-RCMD	LCD annunciator with control - remote operational terminal of the FPA-1000 panel, providing buttons for silence, reset, acknowledge, drill, scrolling keys, key switch with 1358 key, built-in piezo sounder
FMR-1000-RA	LCD annunciator without control - remote LCD annunciator, providing key for acknowledge and scrolling keys, built-in piezo sounder
D7030X	Annunciator, 8 alarm LED - identifies the location of a fire alarm for up to eight zones allowed per system
D7030X-S2	Annunciator, 8 LED (2 supervisory) - with two zones reserved for supervisory functions and with power and trouble LEDs plus eight-zone LEDs that can be individually labeled
D7030X-S8	Annunciator, 8 LED (8 supervisory) - with eight zones reserved for supervisory functions and with power and trouble LEDs plus eight-zone LEDs that can be individually labeled
D7032	Annunciator expander, 8 LED - attaches to a D7030X, D7030X-S2 or D7030X-S8 and identifies the location of a fire alarm for eight additional zones, showing 16 LED zones in the D7030X/D7032 combination

Tab. 2.6: Controla and Annunciators for the Option bus

Modules

Each FPA-1000 supports up to two Octal Relay Modules or Octal Driver Modules.

The outputs are fully programmable and can be activated by system events. These outputs have the same programming options as the local relays. Each output operates independently of the other seven to provide complete flexibility. Communication with the D7035/B or D7048/B is supervised.

Type Number	Description
D7048/B	Octal Driver Module
D7035/B	Octal Relay Module

Tab. 2.7: Option bus modules

NAC Power Supply

The FPP-RNAC-8A-4C Power supply (RNAC 8A 24V) adds four additional NACs (NFPA 72, Class A or Class B) to the fire panel or serves as a power supply for fire protective signaling systems. This regulated power supply provides up to 8 A of power that is used to recharge

batteries and operate continuous and intermittent alarm loads. This 8 A of power can be distributed through the four NAC Power Supply circuits that are part of the FPP-RNAC-8A-4C. The FPP-RNAC-8A-4C is UL Listed for use in commercial fire alarm applications.

Type Number	Description
FPP-RNAC-8A-4C	Power supply, RNAC 8A 24V

Tab. 2.8: NAC power supply for the Option bus

2.7 Signaling Line Circuit Devices

The FPA-1000 fire panels communicate with each of the addressable devices located on the SLCs using fast and reliable protocol that allows the use of standard non-twisted, non-shielded wiring for the SLCs.

Each FPA-1000 supports two Class B, one Class A, or one Class X circuit per SLC.

For a list of all compatible devices for the FPA-1000 SLCs, see the following table.

Type Number	Description
FAP-440-T FAP-440-TC FAP-440-DT FAP-440-DTC [SMOKE-M]	Analog Multi-sensor Detector Photo/Heat Analog Multi-criteria Detector Photo/Heat/CO Incorporates a thermal element and a high performance photoelectric smoke chamber. The -TC model includes a carbon monoxide (CO) sensor as an indicator of fire. Provides two user-selectable modes for making the fire decision: multi-combined and multi-separated mode. Allows programming LED behavior during polling of the internal device LED and a remote connected indicator. D models incorporate dual photoelectric emitters (infrared and blue) to enhance catch performance. Can use addresses 1 to 254.
FAP-325-V2F [SMOKE-P]	Analog Photoelectric Smoke Detector Flat Head Detects optically dense smoke typical of fires involving materials such as soft furnishings, plastic, foam or other similar materials which tend to smolder and produce large visible smoke particles. Allows programming LED behavior during polling of the internal device LED and a remote connected indicator. Can use addresses 1 to 254.
FAP-325 FAP-440 FAP-440-D [SMOKE-P]	Analog Photoelectric Smoke Detector Analog Photoelectric Detector Detects optically dense smoke typical of fires involving materials such as soft furnishings, plastic, foam or other similar materials which tend to smolder and produce large visible smoke particles. The D model incorporates dual photoelectric emitters (infrared and blue) to enhance catch performance.
FAH-325 FAH-440 [HEAT]	Analog Heat Detector Analog Heat Detector Detects heat in environments where smoke detectors are unsuitable because of the presence of steam or cooking fumes, such as in a kitchen.

Type Number	Description
FAI-325 [SMOKE-I]	Analog Ionization Smoke Detector For use in areas where early warning of trouble from superheated or flaming combustibles is expected; also constructed to be used effectively where outside Radio Frequency Interference (RFI) and other electrical interference is expected.
FAA-325-B4 FAA-440-B4 FAA-440-B4-ISO	Analog Detector Base Analog Standard Base (4-inch) Analog Isolator Base (4-inch) Compatible with all analog addressable detectors that use the advanced analog communication protocol, except the FAD-325-DH or FAD-325-V2F-DH. 4-in (10 cm) diameter. ISO base contains built-in circuit isolator.
FAA-325-B6 FAA-440-B6 FAA-440-B6-ISO	Analog Detector Base Analog Standard Base (6-inch) Analog Isolator Base (6-inch) Compatible with all analog addressable detectors that use the advanced analog communication protocol, except the FAD-325-DH or FAD-325-V2F-DH. 6-in (15 cm) diameter. ISO base contains built-in circuit isolator.
FAD-325 FAD-325-DH FAD-325-R FAD-325-V2F FAD-325-V2F-DH FAD-325-V2F-R [SMOKE-D]	Analog Duct Smoke Sensor Replacement Analog Duct Smoke Detector Provides early detection of smoke and products of combustion present in air moving through HVAC ducts in Commercial, Industrial and Residential applications. The FAD-325-V2F-DH is a replacement for the sensor in any of the four duct housing units. The FAD-325-DH is no longer available for purchase, but can be used as a replacement for the sensor in either of the following units: FAD-325 Analog Duct Smoke Detector (with Housing) FAD-325-R Analog Duct Smoke Detector with Relay (with Housing)
FMM-325A FMM-325A-D [CONT-MOD]	Single-action Analog Manual Station Double-action Analog Manual Station Contact monitor module mounted in a corrosion-resistant rugged die-cast housing for single-gang mounting. Loop powered. The FMM-325A/FMM-325A-D devices are connected via an FLM-325-IM Contact Module. For programming, refer to the Contact Monitor information.

Type Number	Description
<p>FLM-325-I [CONT-MOD]</p>	<p>Contact Monitors Designed to use with pull stations, water-flow switches, and other applications requiring the monitoring of dry-contact alarm-initiating devices. Can be programmed in NO EOL, NC EOL, NC no EOL. Independently from the type, the panel lists only an FLM-325-I. Two types available for input switches to be connected as Class B: FLM-325-I4 Contact Monitor 4-inch FLM-325-IM Contact Monitor, Mini Two types available for input switches to be connected as Class A: FLM-325-I4-AI Contact Monitor 4-inch Class A w/Isolator FLM-325-I4-A Contact Monitor 4-inch Class A The types FLM-325-IM, FLM-325-I4-AI, and FLM-325-I4-A can use addresses 1 to 254.</p>
<p>FLM-325-2I4 [CONT-MOD]</p>	<p>Dual Input Monitor Provides two independent contact monitoring circuits while utilizing only one address on the SLC. Can be programmed to monitor normally open or normally closed contact fire alarm and supervisory devices (NO EOL, NC EOL, NC no EOL) Supervises with Style B (Class B), loop powered.</p>
<p>FLM-325-CZM4 [CONVZ-MOD]</p>	<p>Conventional Zone Module Monitors dry contacts (NO) devices such as two-wire conventional detectors or pull stations. Transmits the status of one zone of devices back to the panel (25 maximum per zone; number depends on type of connected devices). Class A or Class B wiring is configured with a jumper on the module Auxiliary (AUX) powered. For compatible devices, refer to the manual supplied with the product. The number of Conventional Zone Modules (FLM-325-CZM4) for each SLC module is limited to 32.</p>

Type Number	Description
FLM-325-2R4 [RELAY-MOD]	<p>Dual Relay Modules</p> <p>Allows independent control of two Form C contacts for a variety of normally open (NO) and normally closed (NC) contact applications such as fan operation, elevator recall, door closure, and auxiliary notification. Loop powered.</p> <p>Five types available:</p> <p>FLM-325-2R4 Dual Relay Module, rated for 1.0 A at 30 V DC or 0.5 A at 125 V AC</p> <p>FLM-325-2R4-2A Dual Relay Module 2A, rated for 2.0 A at 30 V DC or 1.0 A at 125 V AC</p> <p>FLM-325-2R4-2AI Dual Relay Module 2A w/Isolator rated for 2.0 A at 30 V DC or 1.0 A at 125 V AC</p> <p>FLM-325-2R4-8A Dual Relay Module 8A, rated for 8.0 A at 30 V DC or 8.0 A at 250 V AC)</p> <p>FLM-325-2R4-8AIDual Relay Module 8A w/Isolator, rated for 8.0 A at 30 V DC or 8.0 A at 250 V AC)</p> <p>The types FLM-325-2R4-2A, FLM-325-2R4-2AI, FLM-325-2R4-8A and FLM-325-2R4-8AI can use addresses 1 to 254.</p>
D328A [RELAY-MOD]	<p>Analog Relay Module</p> <p>Allows the control of one Form C contact (rated for 1.0 A at 30 V DC or 0.5 A at 125 V DC) for a variety of normally open (NO) and normally closed (NC) contact applications such as elevator recall systems or HVAC shutdown. Loop powered.</p>
FLM-325-N4 [NAC-MOD]	<p>Supervised Output Module</p> <p>Provides a supervised pole reversal output used for acoustic and optical signaling devices or to trigger an RNAC power supply.. Requires a 24 V DC auxiliary input voltage. The output relay is rated to supply 2 A at 30 V DC. Provides Steady, Pulsing and Temporal Code 3 output pattern</p> <p>Class B type:</p> <p>FLM-325-N4 Supervised Output Module</p> <p>Two types available for Class A:</p> <p>FLM-325-NA4 Supervised Output Module Class A</p> <p>FLM-325-NAI4 Supervised Output Module Class A w/Isolator</p> <p>The types FLM-325-NA4 and FLM-325-NAI4 can use addresses 1 to 254.</p>
FLM-325-ISO	<p>Short Circuit Isolator</p> <p>Isolates a shorted section on a specific polling circuit from the rest of the system to minimize the loss of devices.</p>

Tab. 2.9: Compatible SLC devices

When programming the SLC devices, first select the device group type and then specify the type number. See the type designations in brackets in the table above.

2.8 Notification Appliance Circuit Devices

Two Class A or Class B Notification Appliance Circuits (NACs) provide up to 4 A of 24 V power (maximum 2.5 A on each circuit) to operate horns, strobes, bells, and other notification appliances. Each NAC can be programmed to provide Temporal Code 4, Temporal Code 3, and Steady, Pulsing, and synchronized output for Wheelock, System Sensor, and Gentex notification appliances.

For a list of compatible notification appliances, see the FPA-1000 NAC *Compatibility List* available as a PDF at www.boschsecurity.com.

For UL approved notification patterns, see *UL 864 Standard-specific Requirements, page 43*.

2.9 Communicator

Each FPA-1000 has a dual phone line PSTN/DACT circuit and an Ethernet connection featuring Conettix IP reporting. The panel communicates in Contact ID, SIA, and Modem IIIa².

The panel provides miscellaneous reporting functions such as dialing control and transmission supervision, priorities of report groups, routing to destinations, manual and auto test reports, and Anti-Replay feature.

For the primary and secondary account, the following features are programmable:

- Two different phone numbers or IP addresses, or one phone number and one IP address
- Different dialing types for PSTN (pulse only, tone and pulse, or tone only)
- Individual PSTN line supervision (audible and visible trouble signal in the case of a transmission path failure)
- Selectable options for Report Steering Groups
- Programmable supervision time for each Conettix IP reporting account
- Test call frequency individually programmable for each account (4-, 6-, 24-hour, 7- and 28-day intervals)

With modem function, it is possible to program the control panel remotely (upload a new parameter file to the panel from a remote station).

Compatible Device for the PSTN/DACT Circuit and Ethernet Connection

Designation	Description
D6600	Communications Receiver/Gateway
D6100i	Communications Receiver/Gateway

Tab. 2.10: Compatible PSTN/DACT and Ethernet devices

2.10 Components and Accessories

For semi-flush mounting of the control panel cabinet, the FPM-1000-SFMK Semi-flush Mounting Kit with trim ring is available.

The D5070 Analog point programmer provides easy programming of Signaling Line Circuit device addresses.

Alternatively to the complete FPA-1000 Fire panel, you can order separate components. The FPA-1000-LC includes the mainboard with keypad. The FPM-1000-ENC includes the enclosure with the dead front door.

Type Number	Description
FPM-1000-SMK	Semi-flush Mounting Kit Includes trim ring and mounting accessories.

Type Number	Description
D5070	Analog Device Programmer Hand held device that programs address settings on EEPROM-programmable analog devices. With base for detector head programming and two-module program adapter for module programming (for 4-in or single-gang back box). Shows the current analog value of a connected detector.
FPA-1000-LC	Fire panel(2 SLC & networking) without enclosure
FPM-1000-ENC	Enclosure with dead-front door

Tab. 2.11: Optional accessories for the FPA-1000 Fire panels

2.11

Related Documents

To obtain a complete understanding of specific features of the fire control panel and related peripherals, see the following documentation:

- *NAC Compatibility List*
- *Operating Instruction Sheet, FPA-1000*
- *Wiring Diagram*
- *Release Notes*
- *Installation Guide FPE-1000-SLC Signaling Line Circuit*
- *Installation Guide FPE-1000-CITY City Tie Plug-in Module*
- *Installation Guide FPM-1000-SFMK Semi-flush Mounting Kit*
- *Installation and Operation Guide FMR-1000-RCMD Remote Command Center*
- *Installation and Operation Guide FMR-1000-RA Remote Annunciator*
- *Installation Guide FPM-1000-ENC Enclosure With Dead Front Door*

If your system is networked, also see the following:

- *Network Cards Installation Guide*

To download panel-related documents (in PDF format) and software, go to the Bosch webpage (www.boschsecurity.com).

You might also find the current version of some documents supplied with the devices.

3 Planning Information



Warning!

Any panel in a network can control all other panels in the network (e.g. silencing an alarm, resetting the system, etc.). Access to panels should be restricted to properly trained personnel.

If the panel is to be used in a networked system, be careful to plan properly before installing any panels. Check:

- whether the networked panels will be installed near each other or distributed over a wider area
- whether or not any of the networked panels will be in different buildings
- the types and numbers of Networking Cards needed
- interconnection requirements, including the maximum allowable cable lengths which depend on the intended interconnection method (Ethernet, fiber optic cable, or wire)

For each panel, be careful to plan properly before installing any devices. Check:

- the compatibility and number of devices to be connected
- the battery capacity needed
- the wiring requirements, including the maximum allowed cable length
- the installation requirements according to this Installation and Operation Guide, NFPA 72, Local Codes and the Authority Having Jurisdiction (AHJ)

3.1 Power Supply Calculations

To select the proper battery size for your system, calculate the required total current draw of your system using the Microsoft Excel based *FPA-1000_Battery_Calculator.xls*. The spreadsheet can be downloaded at www.boschsecurity.us.

3.2 Network Wiring/Connection Considerations



Notice!

The FPA-1000's network (created by using our network cards) is a peer-to-peer network that is considered to be a signaling line circuit (SLC). As such, it cannot be interconnected to any other network. Such interconnection can result in the failure of the network panels to properly communicate with each other.

3.2.1 Ground Fault Detection

Each networking card has a specific terminal or terminals that are Ground Fault Detection enabled. As indicated by the checked boxes in the following table, Port 1 on all three networking cards is ground fault enabled. The wired card (FPE-1000-NW) also has Port 3 enabled.

Port	-NE		-NF		-NW	
1	<input checked="" type="checkbox"/>	Ethernet IN	<input checked="" type="checkbox"/>	Ethernet	<input checked="" type="checkbox"/>	Wired IN
2	<input type="checkbox"/>	Ethernet OUT	<input type="checkbox"/>	Fiber IN	<input type="checkbox"/>	Wired OUT
3	<input type="checkbox"/>	Ethernet	<input type="checkbox"/>	Fiber OUT	<input checked="" type="checkbox"/>	Ethernet

Tab. 3.12: Network port identification

For Ground Fault Detection to work properly, one and only one end of a communication connection (cable) joining two networking cards must be Ground Fault Detection enabled. To facilitate this, the wired card (FPE-1000-NW) and the fiber optics card (FPE-1000-NF) each

have a jumper located near the back of the Ethernet IN port (Port 3 on the wired card and Port 1 on the fiber optic card). This jumper allows Ground Fault Detection to be disabled for this port. Recommended communication connection practice is to come out of one card and in on the next. In cases where you are switching from a wired or fiber optic card to a different type of card, you must use the Ethernet port which should be OUT (not IN which is the default). Move the jumper on this card so that Ground Fault Detection is disabled at this end of the connection (making it an Ethernet OUT). Remove the jumper from both pins and replace it on only one pin so that it does not get misplaced in case Ground Fault Detection needs to be re-enabled later.

3.3 Configuration and Programming Basics

3.3.1 Points

A point is defined as a device such as an automatic detector, a call point, or input line. Each point in the system is individually identified by the control unit and can be programmed with specific functions or responses. A point can have only one state at a time. Possible states are:

- Normal
- Active
- Bypassed
- Trouble
- Walk test mode

The point is activated in either of the following cases:

- The analog value of an analog detector crosses its threshold level
- An input monitor is activated

The point is dirty if the clean air value reaches a defined upper limit (depending on detector type). This takes place automatically during the calibration processes. After the panel is initialized successfully, the test interval for the calibrated detector sensitivity testing is 4 hours. The dirty condition is handled as a trouble status. If the clean air value is out of range, a calibration trouble status is indicated. The detector is still working, but the sensitivity set point can be different from the configured value. This means the risk of a false alarm increases.

The point is in trouble status in any of the following cases:

- Double address fault is detected on an address
- Wrong type code error is detected
- Missing device is detected on an address
- Other types of fault conditions are detected

If a point is in bypassed status, other status changes are ignored until it is unbypassed. If a point is placed in walk test mode, activation and deactivation of this point are handled differently. Any other condition changes are ignored until the point is no longer in walk test mode.

The point is considered to be normal if it is not in any of the above states.

Point Types

Each of the points in the system can be programmed with its own characteristics. Point types simplify the programming of points by allowing you to define a common set of characteristics for similar points, and then assigning those characteristics to selected points as a point type. Each point is assigned to use the characteristics of one point type, and then is individually programmed for additional characteristics.

A point type defines the condition that is indicated by activation of a point. Each point is programmed with a type. Not all point types are possible on a certain point, especially on an SLC point where a detector exists. The panel lists only the acceptable point types for that SLC device. For details on device type mapping and possible point types for each SLC device type, see the following table.

SLC point type	SLC device group type		
	SMOKE-x, HEAT	CONVZ-MOD	CONT-MOD
Fire Automatic	D	D	P
Fire Alarm Manual		P	D
Waterflow		P	P
Waterflow Delay		P	P
Gas Alarm		P	P
Supervisory	P	P	P
Generic		P	P
Trouble		P	P
AC Failure		P	P
Battery Failure		P	P
Reset		P	P
Silence		P	P
Drill		P	P
Acknowledge		P	P
General Fire Alarm			P
D = default point type, P = possible point type, Blank = not available			
SMOKE-x includes SMOKE-M (FAP-440-T, FAP-440-TC, FAP-440-DT, FAP-440-DTC), SMOKE-P (FAP-325, FAP-325-V2F, FAP-440, FAP-440-D), SMOKE-I (FAI-325), and SMOKE-D (FAD-325, FAD-325-R, FAD-325-DH, FAD-325-V2F, FAD-325-V2F-R, FAD-325-V2F-DH)			
HEAT = FAH-325, FAH-440			
CONVZ-MOD = FLM-325-CZM4			
CONT-MOD = FLM-325-2I4, FLM-325-I4, FLM-325-I4-A, FLM-325-I4-AI, FLM-325-IM			
FMM-325A and FMM-325A-D Manual stations connected via FLM-325-IM Contact monitor are assigned to Fire Alarm Manual by default and are programmable a Supervisory.			

Tab. 3.13: Mapping point types to SLC device types

Generic point type can be used for output control with input activation. Activation of an input programmed as Generic point type generates an entry "Generic" in history but no off-normal event.

The point type General Alarm can be used for a key switch connected to a Contact Monitor Module or Input Module (type CONT-MOD) to activate a fire alarm without delay. A General Alarm overrides any Sandwich alarm delays (see *Special Alarm Features, page 34*).

3.3.2 Advanced Point Features and Processing

The panel provides flexible handling on a point so that more optional features are accomplished. These features are applicable to specific types. The control panel lists only possible point features for that point type when programming on menu and Web pages. For mapping of point type to available point features, see the following table.

Point type	Point feature					
	Latching	AV	PAS/ Pre-signal	PAS (D)/ AV (N)	Waterflow delay	AC fail delay
Fire Automatic	X	P ¹⁾	P	P ¹⁾		
Fire Alarm Manual	X					
Waterflow	X					
Waterflow delay	X				X	
Gas Alarm	X					
Supervisory	G					
Generic						
AC Failure						X
General Fire Alarm	X					
AV = Alarm Verification PAS = Positive Alarm Sequence D = Day, N = Night ¹⁾ Not for FAH-325			X = Fixed point feature P = Programmable point feature G = Dependent on global setting Blank = not available			

Tab. 3.14: Mapping point types to point features

The following principles apply:

- For Supervisory point type, programming of latching or non-latching is panel-wide.
- The point types Generic, Trouble, AC failure, Battery Failure, Reset, Silence, Drill, and Acknowledge are non-latching (see *Points, page 24*).
- For the Fire Automatic point type, only one of three programmable features can be selected - AV, or PAS/Pre-signal or PAS (Day)/AV (Night). AV and PAS (Day)/AV (Night) do not apply for the FAH-325 Analog Heat Detector.

Delay options can be selected individually for each SLC Fire Automatic input.

To program an SLC device:

- By keypad, use shortcut 6-1 for PROGRAMMING-SLC DEVICES (see *Shortcuts, page 91* and/or *Menu Structure, page 92*)
- By browser, program SLCs on the SLC 1 and/or SLC 2 screens

The following table shows the prioritization of both delay settings:

Programming SLC Fire Automatic Input	Day Mode (Site Data)		
	No delay	PAS	Pre-signal
No delay	No delay	No delay	No delay

Programming SLC Fire Automatic Input	Day Mode (Site Data)		
	No delay	PAS	Pre-signal
AV	AV	AV	AV
PAS/Pre-signal	No delay	PAS	Pre-signal
PAS (D)/AV (N)	AV	PAS	Pre-signal

AV = Alarm Verification PAS = Positive Alarm Sequence D = Day, N = Night

Tab. 3.15: Prioritization of Day Mode and SLC Input Delay options

Alarm Verification

If an input point is configured and goes into an active state, the panel does not immediately indicate the alarm and activate associated outputs, but resets the input point and waits for a verification period (programmable) to see if the point is still active.

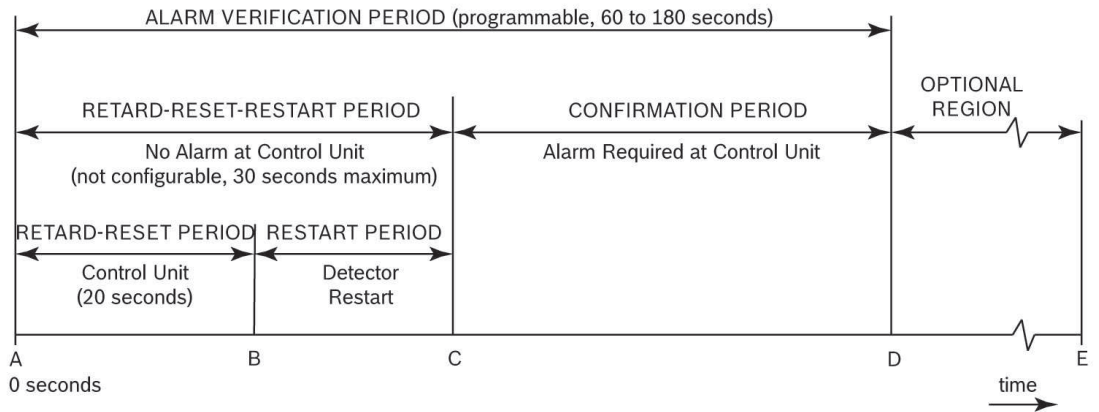

Figure 3.1: Alarm Verification timing diagram

A	Smoke detector goes into alarm.
A-B	RETARD-RESET PERIOD: Control unit senses detector in alarm and retards (delays) alarm signal. Fixed, 20 seconds.
B-C	POWER UP PERIOD: Power to the detector is reapplied and time is allowed for detector to become operational for alarm (detector restart). Time depends on the device type (detector maximum 3 seconds, Conventional Zone Module maximum 10 seconds).
A-C	RETARD-RESET-RESTART PERIOD: No alarm obtained from control unit. Not configurable, 30 seconds maximum.
C-D	CONFIRMATION PERIOD: Detector is operational for alarm at point C. If detector is still in alarm at point C, control unit will alarm. If detector is not in alarm, system returns to standby. If the detector re-alarms at any time during the confirmation period the control unit will alarm. Time depends on detector restart and overall alarm verification period.
A-D	ALARM VERIFICATION PERIOD: Consists of the retard-reset-restart and confirmation periods. Programmable 60 to 180 seconds.
D-E	OPTIONAL REGION: Either an alarm can occur at control unit or restart of the alarm verification cycle can occur.

- Alarm verification is applicable only to analog smoke or 2-wire smoke detectors of the Fire Automatic type. The alarm verification option is not applicable to Fire Alarm Manual and Waterflow point types.
- The alarm verification option is arranged on a per point basis.
- After the alarm verification period starts, any alarm from anywhere in the system that occurs during the alarm confirmation cycle immediately results in an alarm indication.
- The alarm verification timer is system wide; thus, only one timer applies for the whole system.
- The alarm verification timer is user programmable, ranging from 60 to 180 seconds. The default is 60 seconds. See *UL 864 Standard-specific Requirements*, page 43.
- A reset command is sent to reset the input point on SLCs for alarm verification.
- The global alarm verification zone is activated if the panel is in the verification period.
- The Alarm Verification feature is valid in a networked system.



Notice!

CSFM installations require the alarm verification Retard-Reset-Restart (A-C) time to be a maximum of 30 seconds. This time is not programmable and is always less than 30 seconds, by design. The programmable alarm verification time in this panel is the complete Retard-Reset-Restart-Confirmation (A-D) cycle.

Waterflow Delay

- The Waterflow delay is applicable only to point type “Waterflow with delay”.
- The Waterflow delay enable option is arranged on a per point basis.
- Each point configured with Waterflow delay has its own timer.
- The Waterflow delay timer is user programmable, ranging from 10 to 90 seconds. The default is 90 seconds.
- The input point must remain constantly in an active state for the complete time delay. Any interruption resets the timer.

Latching

If a point is “Latching”, after activation it can return to the normal state only by a reset operation.

- The latching enable option is arranged on a per point basis
- Latching is programmable only for points of the supervisory type
- For other types of points, the latching option is fixed:
 - “Latching” for Fire, Waterflow, Gas Alarm, and General Alarm point type
 - “Non-latching” for Generic, Trouble, AC Failure, Battery Failure, Reset, Silence, Drill, and Acknowledge point type

Pre-signal

If an input point is configured as “Pre-signal enabled” and it becomes active, the activation of outputs (for example NACs) associated with that input point is delayed. Other responses, including message display update, LED indication, piezo mode change, central station reporting, and history log, are immediately generated.

- Pre-signal is applicable to points of the Fire type only.
- Pre-signal is arranged on a per point basis.
- If a second alarm occurs during the Pre-signal delay time, the second alarm is immediately processed and all outputs associated with both alarmed input points are activated.
- Any outputs assigned to a Pre-signal zone are activated immediately on initial alarm.
- The Pre-signal timer is system wide; thus, only one timer applies for the whole system.

- The Pre-signal timer is user programmable, ranging from 60 to 180 seconds. The default is 180 seconds.
- The Pre-signal delay feature can be enabled or disabled for each input device individually.
- The global Pre-signal zone is activated if the panel has a Pre-signal input active and is in the "waiting for reset" period.
- The Pre-signal feature, if enabled, is valid only under Day Mode. The panel can be in either PAS mode or Pre-signal mode, not both.
- The Pre-signal feature is valid in a networked system.



Notice!

In case the Pre-signal option is configured, install a pull station next to the FPA-1000 in order to activate the alarm manually.

Positive Alarm Sequence (PAS)

The PAS feature is applicable only to automatic fire detection devices that are the Fire type (analog and 2-wire smoke or heat detectors).

- PAS is arranged on a per point basis.
- All system evacuation signals associated with the activated initiating device and any off-premises signaling activate immediately and automatically when:
 - The alarm signal from an automatic fire detection device is not acknowledged within 15 seconds of annunciation at the system’s operator interface.
 - The system is not manually reset within the programmed PAS investigation time of the acknowledgment described in (a).
 - When a second automatic fire detector selected for positive alarm sequence actuates before the system is reset as described in (b); or when any other fire initiating device reporting to the system or control unit actuates.
- The PAS timer is system wide; thus only one timer applies for the whole system.
- The PAS timer is user programmable, ranging from 60 to 180 seconds. The default is 180 seconds.
- The PAS feature can be enabled or disabled for each input device individually.
- In addition, the panel provides a global option to enable or disable PAS.
- The panel can be in either PAS mode or Pre-signal mode, not both.
- The PAS feature, if enabled, is valid only under Day Mode.
- The PAS feature is valid in a networked system.



Notice!

For Positive Alarm Sequence details, refer to NFPA 72 and UL 864.

3.3.3

Events

All point and system events are classified by event groups.

Point events are generated as point status changes.

Each type of point event belongs to a group that is based on when the panel displays and reports the event in a prioritized style. For a list of point events and the event groups to which they belong, see the following table.

Point Event	Event Group
Point bypassed	Point trouble
Point unbypassed	Point trouble restore

Point Event	Event Group
Point event upon activation	Handled depending on the point type programmed (see Point Activation Events table below)
Point event upon deactivation	
Point trouble	Point trouble
Point trouble restore	Point trouble restore
Point walk test activation	Test
Point walk test deactivation	Test

Tab. 3.16: Mapping point events to trouble event groups

The event generated upon point activation or deactivation is determined by the point type. For a list of possible point events derived from point activation and the group to which the event belongs, see the following table.

Point Type	Event or Operation		Event Group	
	by Point Activation	by Point Deactivation	by Activation	by Deactivation
Fire Auto	Fire alarm	Fire alarm restore	Alarm	
Fire Alarm Manual	Fire alarm	Fire alarm restore	Alarm	
Waterflow	Waterflow alarm	Waterflow alarm restore	Alarm	
Supervisory Non-latching	Fire supervisory	Fire supervisory restore	Supervisory	Supervisory restore
Supervisory Latching	Fire supervisory	Fire supervisory restore	Supervisory	
Generic	Generic alarm	Generic alarm restore		
Trouble	Point trouble	Point trouble restore	Point trouble	Point trouble restore
AC Failure	Point AC failure	Point AC restore	Point trouble	Point trouble restore
Battery Failure	Point battery failure	Point battery restore	Point trouble	Point trouble restore
Reset	Reset operation			
Silence	Silence operation			
Drill	Drill operation			

Point Type	Event or Operation		Event Group	
	by Point Activation	by Point Deactivation	by Activation	by Deactivation
Acknowledge	Acknowledge operation			
General Fire Alarm	Fire alarm		Alarm	

Tab. 3.17: Point activation events

The events are classified as groups so that they are prioritized on the display and report by groups.

When a component, a part, a functional block, or any system elements supervised by the software is determined to be faulted or back to normal from a fault condition, an appropriate “System trouble” or “Restore event” is generated.

3.3.4 Zones



Notice!

Before programming inputs and outputs, program the zones first. Mapping inputs and outputs to a zone is then easier.

Zone mapping

The control panel supports a flexible system to map input points to outputs. The system defaults so that all NAC outputs are activated by a fire alarm. By programming output zones, you can create almost any output activation scheme, such as "floor above and floor below" activation or conditional elevator recall.

- Input points: Smoke detectors, pull stations, and so on
- Zone: A group of input points (zones 1 to 225 are configurable, 226 to 234 are activated automatically)
- Outputs: Notification Appliance Circuits (NACs) such as bells, strobes, and relays

Zone mapping on a networked system:

- For each panel on the network there are 128 local zones (pp-001 to pp-128, where pp = the panel ID). Local zones are used to assign inputs and outputs specific to a device at that zone address and to that panel.
- Each network also has 97 grouped zones (129 to 225). Grouped zone addresses allow inputs and outputs to be assigned to multiple panels within a network so that the inputs and outputs of each panel in the grouped zone can be connected to any of the panels in the network.
- Each network also has 9 global zones (226 to 234). Global zones have preset inputs based on device types, but their outputs can be defined and apply to the entire network.
- For local zones and group zones, up to 5 zones per input and 5 zones per output can be mapped. More specifically, an input can be mapped to local zones on any panel within the network or to group zones. The outputs from a local zone (1-128) can be mapped only to the panel that zone is connected to, but the output from group zones (129-225) can be mapped to any panel within the network.

Mapping principles:

- Inputs activate zones, and zones activate outputs.
- Input points can be assigned to up to five local or group zones. Therefore, each input can activate up to five zones; however, any number of inputs can be mapped to the same zone.
- Up to five local, group, and/or global zones can be assigned to each output (except the FAA-325-B6S Analog Sounder Base which can be assigned to only one zone).
- Zones 1 to 225 are available for the installer to program.
- Zones 226 to 234 are global zones and are hard-coded to pre-assigned conditions. They are automatically activated by inputs if a special condition occurs or the panel is in a processing sequence (See the following two figures). It is not possible to assign an input point to any global zone.
- An output can be assigned to a global zone so that it will be activated upon the corresponding special condition. For example, any input that is configured as a "Fire Auto" type activates Zone 226 when it is alarmed. Any output driven by Zone 226 activates when any "Fire Auto" type point is alarmed.

For how inputs control zones and zones control outputs in a network, see the following figure.

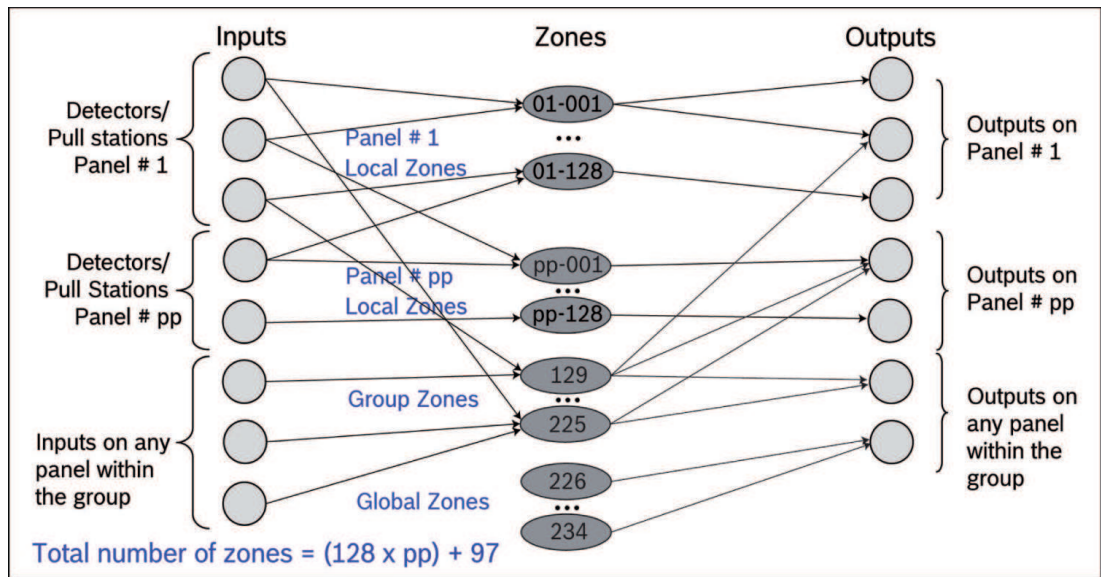

Figure 3.2: Network input-output mapping

For how inputs control zones and zones control outputs in a stand-alone panel, see the following figure.

Input point 1 is assigned to zone 1, mapped to NAC Point 1.

Input point 2 is assigned to zone 2, mapped to NACs 1 and 2.

Input point 3 is assigned to zone 2, mapped to NACs 1 and 2.

Input point 4 is assigned to zone 2, mapped to NACs 1 and 2.

Input point 5 is assigned to zone 3, mapped to NACs 2, MBR 1 and RR 1.

Global alarm zone 226 drives MBR 2
 MBR = Mainboard Relay (Local Relay)
 RR = Remote Relay (SLC or Option Bus)

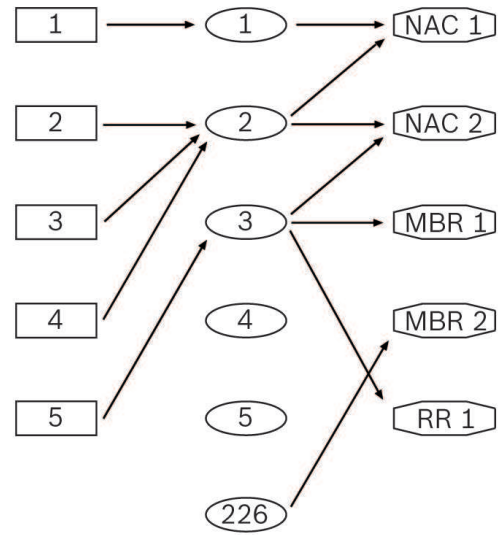

Figure 3.3: Stand-alone panel zone mapping

For a list of all global zones on the panel (each has a unique number), see the following table.

Global Zone Number	Condition Activating Zone
226	Global fire alarm
227	Global trouble
228	Global supervisory
229	Alarm verification (verification period)
230	Pre-signal (waiting for reset)
231	Positive Alarm Sequence (waiting for ACK or reset)
232	Panel is resetting
233	Global gas alarm
234	Global waterflow

Tab. 3.18: Pre-assigned zones

In some cases if a relay output is assigned to a certain global zone, other assigned zones are ignored:

- Mainboard relay 1: If assigned to the global alarm zone, other assigned zones are ignored. The relay reacts only to the global alarm zone.
- Mainboard relay 2: If assigned to the global trouble zone, other assigned zones are ignored. The relay reacts only to the global trouble zone.
- Mainboard relay 3: If assigned to the global supervisory zone, other assigned zones are ignored. The relay reacts only to the global supervisory zone.

Outputs

is active if any zone to which the output is assigned is activated. An output which is assigned to multiple zones can be considered as inactive only when all associated zones are inactive.

NAC pattern assignment

Every zone is assigned to one NAC pattern. When the zone NAC pattern is set to default, the device NAC pattern is used. In case of a device activation by address, the device NAC pattern is used. When a device is activated by a zone activation command, the NAC activates with the assigned zone pattern (Steady, Pulsing, or Temporal Code 3, for global gas alarm also Temporal Code 4). See the following table.

Zone NAC Pattern Assignment	Activation	Used NAC Pattern
Default	By zone	Device NAC pattern
Any but default	By zone	Zone NAC pattern
Default or any other	By address	Device NAC pattern

Tab. 3.19: NAC pattern assignment

Counting zones

All local or group zones have the “Counting Zones” option. If this option is enabled, a local or group zone becomes a counting zone.

Otherwise, it is a non-counting zone which is activated as soon as an input point assigned to this zone is activated. If multiple points (can be from different panels if networked) are assigned to a single zone, only when all the points are inactive is the zone considered as inactive; thus, associated outputs can be deactivated.

A counting zone is considered active only when two or more input points assigned to that zone are active. It is not allowed to assign an input point programmed with any delayed point features (including PAS, Pre-signal, alarm verification, and PAS@day or alarmverification@night) to a counting zone.



Notice!

When implementing the counting zone feature, a minimum of two detectors is required in each protective space. Also all points on the ceiling shall have a detector within a distance equal to 0.7 times the listed spacing (0.7S).

Bypassing zones

If a user bypasses a zone, all inputs and outputs assigned to this zone are bypassed. Bypassed elements are processed as trouble conditions. Events from bypassed elements are ignored until restored or unbypassed.

Zone status display

If a zone is activated, the corresponding zone LED on the remote LED annunciator is turned on. If the zone is deactivated, the corresponding LED is turned off.

3.3.5

Special Alarm Features

Alternatively to the delay features alarm verification (AV), pre-signal and Positive Alarm Sequence (PAS), the panel offers the special delay features dual-zone alarm and sandwich alarm.

The user has to select globally whether the panel enables AV/Pre-signal/PAS or Sandwich/ Dual-zone features. To program global Delay options:

- By keypad, use shortcut 6-6-4-5 for PROGRAMMING-TIMERS AND SYSTEM-ADVANCED FEATURES-GLOBAL DELAY MODE (see *Shortcuts, page 91* and/or *Menu Structure, page 92*)
- By browser, change the Timer Settings on the Site Data screen

Dual-zone alarm

The dual-zone alarm option allows for programming dual-zone dependency.

If a detector, which is programmed as Fire Auto point type and allocated to a dual-zone, is activated, a history entry Unverified trouble is created. The zone is not activated upon the first detector's activation unless a second detector belonging to the dual-zone goes to alarm. After the second detector confirms the alarm, the fire alarm system performs all activations such as triggering the notification appliances, triggering the dialer, reporting, LED indication and so on.

- One panel can have up to 18 dual-zone pairs.
- In a networked system, two zones from two panels in the network can be paired.
- One zone can be allocated to four dual-zone pairs.
- The first alarm can be programmed as First alarm latching as a global option.
- If the first alarm is configured as Not latching, the time period between the activation of the dual-zone and the reset of the first alarm can be set by a global timer (default is 60 s).
- If more than one detector is activated within one zone, the second and any further activation receives a time stamp but does not influence the first alarm activation.
- A zone that belongs to a dual-zone cannot have other delay features, such as PAS, pre-signal and alarm verification.
- One zone can belong either to a counting zone or a dual-zone, but not both at the same time.
- It is possible to have sandwich and dual-zone features simultaneously enabled on one zone.
- Any alarm activated from a manual call point or a key switch is handled as an immediate alarm, disregarding any dual-zone dependency.

Sandwich Alarm

The sandwich alarm feature allows for the time-triggered phased evacuation, floor by floor, in case of a fire alarm inside a building.

All NAC zones can be grouped by floor. This is achieved by assigning NACs to local or group zones, then assigning zones to floors. These floors are logically mapped to floors in a building, where adjacent floors are mapped to neighboring floor numbers.

The user can program rules that define which zones are activated after a Fire or Waterflow alarm occurred in a certain zone.

The sandwich alarm cannot be programmed as a global function. A "General" alarm from a key switch immediately activates all NACs and a set of associated control relays.

On one panel, sandwich alarm and delay features (i.e. PAS, Pre-signal or Alarm Verification) cannot be enabled simultaneously.

On one zone, sandwich alarm and counting zone features cannot be enabled simultaneously.

The sandwich alarm programming allows for three evacuation phases with a delay time of 1 to 10 minutes per phase. The maximum delay time of all three phases is 30 minutes in total.

For example, the sandwich alarm procedure can be programmed as follows:

1. Evacuate the floor where the alarm occurs. All local indication is activated to initiate this.
2. After the programmed delay time expires, the neighboring floors are activated to evacuate the floors above and below, and any silenced outputs are reactivated.
3. After another programmed delay time expires, all floors are activated to evacuate the whole building, and any silenced outputs are reactivated.

If during phase 1) or 2) another alarm occurs, the same procedure starts for the affected floors. The second alarm has no impact on the running alarm procedure. For example, if phase 3) for the first alarm is reached, the complete building is evacuated.

A drill command during the sandwich procedure directly evacuates the whole building.

During a sandwich alarm procedure, the acknowledgement and the silence operation work as usual.

Reset operation stops all running sandwich timers and turns off all activated or silenced outputs.

In a networked system, floors are valid network wide. Thus, local zones on different panels or group zones can be assigned to any floor.

3.3.6 Sequential Reset

To prevent high inrush to the electrical system, the sequential reset option can be programmed for each relay individually if needed.

If a sequential reset is enabled, pressing the reset button causes the relays to reset with a time delay between each relay deactivation. The relay deactivation starts from Mainboard, then Option Bus, and then SLC. Within a circuit, the relay deactivation is performed one by one, from lowest number to highest.

The delay time for the sequential reset is programmed globally, ranging from 4 to 10 seconds.

The individual relay activation or deactivation under test mode is performed immediately, regardless of the sequential reset setting for the relay.

3.3.7 Multi-combined/multi-separated Alarm Modes

Some Bosch Security Systems, Inc. detectors incorporate a thermal element and a high performance photoelectric smoke chamber. Additionally, some of these detectors also incorporate a carbon monoxide (CO) sensor. In detectors with CO sensors, the photoelectric sensitivity is modified by input from the CO sensor. These detectors have two alarm modes for making the fire decision: multi-combined mode or multi-separated mode.

In the multi-combined mode, the alarm is activated by either the smoke or heat sensor or by both. The detector essentially works as a photoelectric smoke detector, modified according to the temperature and the CO level, if a carbon monoxide sensor is included. The photoelectric sensitivity is modified by linking the smoke sensor and the heat sensor using an algorithm.

In the multi-separated mode, the fire alarm indication occurs only when the heat sensor is activated. Activation of the smoke sensor only creates a Supervisory or Generic event in the history file, and the sounder base holding the detector is activated (local alarm indication). You can select this mode only when a sounder base is attached and it is programmed as Activated by host. When the smoke activation is restored, the sounder base is deactivated while another history entry is created.

If the point type Supervisory is selected, the smoke point type is Generic by default and cannot be modified.

Diagnostic information is listed for the smoke sensor (SMOKE-M-S) and the heat sensor (SMOKE-M-H) individually.

3.3.8 External Signaling

Relays programmed with external signaling (Ext. signaling) will be deactivated upon silencing and, once deactivated, only reactivated by an additional signal from an activated zone.

3.4 Address Assignment

All circuits connected to the FPA-1000 are assigned to a fixed circuit address. The circuit address is used on the display, in reports and history files.

Circuit Address [C or CC]	Fixed Circuit Address Assignment
0	Web page

Circuit Address [C or CC]	Fixed Circuit Address Assignment
1	SLC 1
2	SLC 2
3	Mainboard (MB)
4	Option Bus (OB)

Tab. 3.20: Fixed circuit address assignment

3.4.1

Option Bus Address Assignment

Each Option Bus device must be set to a unique address ranging 1 to 23. Observe the address restrictions listed in the following table.

Address	Fixed Address Assignment
1 to 8	LED Annunciators (for model types, see <i>Modules, page 16</i>)
9 to 10	D7035/B Octal Relay Module or D7048/B Octal Driver Module
11 to 14	FPP-RNAC-8A-4C Remote Notification Appliance Circuit Power Supply
16 to 23	FMR-1000-RCMD or FMR-1000-RA LCD annunciator

Tab. 3.21: Option bus address restrictions

Zone LED Mapping

The panel supports up to eight pairs of D7030X Family/D7032 annunciators allowing a total of 128 (8 x 16) zone LED indications.

All D7030X/D7032 LEDs are mapped to either (not both) local (1-128) or group (129-225) zones. For an explanation of how to map the LEDs to zones, see the following table.

Option Bus Address	Local Zones		Group Zones	
	D7030X	D7032	D7030X	D7032
1	1 - 8	9 - 16	129 - 136	137 - 144
2	17 - 24	25 - 32	145 - 152	153 - 160
3	33 - 40	41 - 48	161 - 168	169 - 176
4	49 - 56	57 - 64	177 - 184	185 - 192
5	65 - 72	73 - 80	193 - 200	201 - 208
6	81 - 88	89 - 96	209 - 216	217 - 224
7	97 - 104	105 - 112	225	
8	113 - 120	121 - 128		

Tab. 3.22: Zone LED mapping

Every Option Bus address is mapped to 16 zones, regardless of whether a D7030X exists or whether a D7032 is attached to the D7030X on that address.

If a D7030X-S2 is used instead of D7030X, the first two yellow LEDs (Supervisory) are mapped to the first two zones that are associated with the address. If a D7030X-S8 is used instead of D7030X, the first eight yellow LEDs (Supervisory) are automatically mapped to the first eight

zones associated with the address. If either the D7030X-S2 or the D7030X-S8 is used instead of a D7030X on an address, the user is responsible to program the first two or eight zones for that address to Supervisory zones.

The Power and Trouble LEDs on a D7030X copy the status of the corresponding LEDs on the panel keypad.

See also

- *Modules, page 16*

3.4.2

SLC Address Assignment

The standard control panel supports one Signaling Line Circuit (SLC) for up to 254 detectors and modules, or up to 127 analog sounder bases in combination with a suitable detector, for a total of 254 addressable device capacity per SLC.

For a list of permitted address ranges for SLCs, see the following table.

Device Category	Device Group Type	Type Number	Address Range
Detector	SMOKE-M	FAP-440-T	1-254
		FAP-440-TC	1-254
		FAP-440-DT	1-254
		FAP-440-DTC	1-254
	SMOKE-P	FAP-325	1-127
		FAP-325-V2F	1-254
		FAP-440	1-254
		FAP-440-D	1-254
	HEAT	FAH-325	1-127
		FAH-440	1-254
	SMOKE-I	FAI-325	1-127
	SMOKE-D	FAD-325-DH	1-127
		FAD-325-V2F-DH	1-254
	Contact Monitor Module	CONT-MOD	FLM-325-2I4
FLM-325-IM			1-254
FLM-325-I4			1-127
FLM-325-I4-A			1-254
FLM-325-I4-AI			1-254
Relay Module	RELAY-MOD	D328A	1-127
		FLM-325-2R4-2A	1-254
		FLM-325-2R4-2AI	1-254
		FLM-325-2R4-8A	1-254
		FLM-325-2R4-8AI	1-254

Device Category	Device Group Type	Type Number	Address Range
Supervised Output Module	NAC-MOD	FLM-325-N4	1-127
		FLM-325-NA4	1-254
		FLM-325-NAI4	1-254
Conventional Module	CONVZ-MOD	FLM-325-CZM4	1-127

Tab. 3.23: SLC address assignment

You can use addresses 1 to 127 for any combination of detectors and modules. Some SLC devices can use addresses 1 to 254.

Detectors connected to a sounder base can use only addresses 1 to 127.

Addresses 128 to 254 are reserved for analog sounder bases. The sounder bases are addressed automatically by the panel, depending on the detector's address (detector address +127).

The number of Conventional Zone Modules (FLM-325-CZM4) per SLC module is limited to 32. Each device on the SLC must have a unique address. A double address trouble is reported, but can be resolved only automatically by the panel.

For instructions on programming the address into each analog addressable device, see Addressing SLC devices in *SLC module*, page 61.

3.4.3

Mainboard Address Assignment

The mainboard addresses are used for the event reporting (see *Reporting Codes*, page 128).

Address	Device Description	Comment
1	Relay 1	Bypass
2	Relay 2	Bypass
3	Relay 3	Bypass
4	NAC1 Control	Open/Short/Overcurrent
7	NAC2 Control	Open/Short/Overcurrent
20	Battery Charger	Failure
21	Battery	Failure
26	IP reporting path 1	Disconnect
27	IP reporting path 2	Disconnect
28	Communication to primary account	Failure
29	Communication to secondary account	Failure
32	City Tie 1	Open/Short/Activated/Activated Fail
33	City Tie 2	Open/Short/Activated/Activated Fail
34	City Tie Board	Missing
35	Mainboard	Total NAC Overcurrent
36	Network Interface Card (NIC)	Missing

Address	Device Description	Comment
37	PORT 1	NIC Port 1 Disconnect
38	PORT 2	NIC Port 2 Disconnect
39	PORT 3	NIC Port 3 Disconnect
46	Wiring	Open loop of topology
47	New Panel	New panel (according to panel list)
48	Panel Reused ID	Panel ID used more than once
49	Group Configuration	Group configuration conflict
50	Global Configuration	Global configuration conflict
51	Control	Control command conflict
52	Panel Missing	Missing panel (according to panel list)
53	OutOfSync	indicates events on a panel or panels are not fully synchronized with events on another panel or panels

Tab. 3.24: Mainboard address assignment

3.5

Reporting Requirements



Notice!

For UL Listed Fire Installations, shared on premises communications equipment must be UL Listed for Information Technology Equipment.

The communicator can report to two phone numbers, two IP addresses, or one phone line and one IP address with full, single, double, and back-up reporting.



Caution!

When programming two accounts with different IP addresses, each account must be programmed to a different port to prevent IP path and/or COMM fault trouble.

Possible DACT communication formats are:

- SIA-DCS 300 no text
- Modem IIIa² no text
- Contact ID
- SIA-DCS 300 with text
- Modem IIIa² with text



Notice!

The communicator must be enabled and configured before it operates. The communicator and phone line monitors are disabled in the default factory configuration.

Phone Line and Phone Number/IP Selection

To ensure the delivery of critical reports, the fire panel has two phone lines and two phone numbers or IP addresses that can be used for reporting. Reports can be directed to one or both of two phone numbers or IP addresses using the Report Steering feature in the control panel programming.

To program reporting selections:

- By keypad, use shortcut 6-7 for PROGRAMMING-DACT (see *Shortcuts, page 91* and/or *Menu Structure, page 92*)
- By browser, use the Reporting screen

Note that Account Number 1 is used with Phone Number/IP 1, and Account Number 2 is used with Phone Number/IP 2. Except for test reports, the control panel automatically selects the phone line or IP address to use. If the phone line monitor shows that a line is bad, when a report is sent, it automatically picks up the other line. If the report is not successful after the defined number of attempts on Line 1, the control panel automatically switches and uses Phone Line 2. The one exception is when test reports (manual or automatic) are sent. Auto test reports are sent every 4 hours to 28 days. Each time a test report is sent, the control panel alternates phone lines. If the user sends two manual test reports, both phone lines can be tested. With the default auto test interval of 24 hours, the automatic test uses a different line each time.



Notice!

Report received every other time

If the central station receives the automatic test report only every other time, this indicates that one phone line at the protected premises is inoperative. Correct this condition immediately, because other critical reports can be delayed when the communicator is trying to send the test signal through the inoperative phone line.

Because the control panel automatically selects which line to use, both phone lines must use the same dialing sequences for sending reports. For example, a line that requires a "9" to be dialed for an outside line cannot be paired with a line that does not require a "9". PBX lines and ground start phone lines do not comply with NFPA requirements for digital communication.

While the communicator is idle, the FACP monitors the primary and alternate telephone lines by testing the line for trouble. The FACP sniffs each line every 12 seconds. When a trouble still exists after three samples (36 seconds), the FACP sends a trouble report and activates the yellow trouble LED and the trouble relay.

Although two independent phone lines are required for UL 864 Central Station service, the FACP can be configured with one phone line if the communicator is used only for supplemental reporting on a local, remote station or auxiliary system.



Warning!

Communicator reports can be delayed if the dialer outputs are not connected together on an installation where the control panel has only one phone line.

Phone Line Attempt Matrix

The maximum number for panel reporting attempts is programmable (range 5 to 10 for each line). When the programmed number of attempts is reached, the panel indicates a communication failure for the destination.

If both destinations (accounts) are programmed to PSTN, the attempts occur according to the table below.

Attempt Number	Phone Line 1	Phone Line 2	Primary Account	Secondary Account
1	X		X	
2	X			X
3		X	X	
4		X		X
5	X		X	
6	X			X
7		X	X	
8		X		X
9	X		X	
10	X			X
11		X	X	
12		X		X
13	X		X	
14	X			X
15		X	X	
16		X		X
17	X		X	
18	X			X
19		X	X	
20		X		X

Tab. 3.25: Phone line attempt matrix

Supervision time (in seconds) = (ACK wait [s] x retries) + Polling rate [s]

Configured Supervision Time	Acknowledge wait time	Heartbeat interval ¹	Communication tries
90 sec	5 sec	30 sec	5
180 sec	15 sec	60 sec	5
200 sec	15 sec	80 sec	5
5 min	15 sec	180 sec	5

¹ The heartbeat interval includes a built-in minimum 30 second buffer.

Tab. 3.26: Supervision time settings

See also

- *Shortcuts*, page 91
- *, page 97*

3.6 UL 864 Standard-specific Requirements



Notice!

The system must be tested after installation and after any re-programming, including programming performed by downloading.

Initial remote programming must be manually accepted at the panel.



Notice!

To all Users, Installers, Authorities Having Jurisdiction, and Other Involved Parties

This product incorporates field-programmable software. In order for the product to comply with the requirements in the Standard for Control Units and Accessories for Fire Alarm Systems, UL 864, certain programming features or options must be limited to specific values or not used at all as indicated below.

For a list of the required program entries and required accessories for UL Listed Commercial Fire Alarm installations (Central Station [DACT] and Local), see the following table.

Program Feature or Option	Permitted in UL 864	Possible Settings	Settings Permitted in UL 864
Remote Programming	Yes	REMOTE PROG 1-CONFIRM AT PANEL 2-ENABLE 3-DISABLE	1-CONFIRM AT PANEL 3-DISABLE
Mainboard Relay	Yes	MB RELAY 1/2/3 NORMAL 1-ENERGIZED 2-NOT ENERGIZED	If programmed as Trouble: 1-ENERGIZED If programmed as Fire Alarm, Supervisory, Gas Alarm, or By Zones: 2-NOT ENERGIZED
FLM-325-I4/-IS/-IW Input type	Yes	L1 A007.0 INPUT TYPE 1-NORMAL OPEN EOL 2-NORMAL CLOSE EOL 3-NORMAL CLOSE NO EOL	1-NORMAL OPEN EOL
FLM-325-2I4 Input 1 and 2 Input type	Yes	L1 A010.1 INPUT TYPE/ L1 A010.2 INPUT TYPE 1-NORMAL OPEN EOL 2-NORMAL CLOSE EOL 3-NORMAL CLOSE NO EOL	1-NORMAL OPEN EOL
Alarm verification	Yes	60-180 s	90-120 s
AC Fail Delay Time	Yes	0 to 6 hours	1 to 3 hours

Program Feature or Option	Permitted in UL 864	Possible Settings	Settings Permitted in UL 864
Primary/Secondary Account Auto Test Frequency	Yes	PRIMARY TEST FREQ/ SECOND TEST FREQ 1-Disabled 2-4 HOURS 3-6 HOURS 4-24 HOURS 5-7 DAYS 6-28 DAYS	2-4 HOURS 3-6 HOURS 4-24 HOURS (depends on version of standard)
Maximum Communication Attempts	Yes	MAX ATTEMPTS 3 to 10 attempts (each line)	5 to 10 attempts total for both lines
Anti-replay option	No	ANTI-REPLAY 1-ENABLE 2-DISABLE	2-DISABLE
Encryption option for IP reporting	No	ENCRYPTION ENABLE 1-ENABLE 2-DISABLE	2-DISABLE
Line 1/Line 2 Enable	Yes	1-ENABLED 2-DISABLED	1-ENABLED
Line 1 Ring Count	Yes	0 to 10	0

Tab. 3.27: Programming requirements according to UL864

Required Accessories

At least one UL Listed smoke detector with a base. At least one horn strobe or bell listed in the NAC Compatibility List, providing 85 dB for UL864 and NFPA 72 requirements, is required for this application, and must be installed inside the protected area. Four-wire detectors must be used with UL Listed power supervision devices. All devices must be used with the End of Line (EOL) resistor provided.

Configuration Requirements

If alarm verification is enabled, do not mix pull stations and conventional heat detectors on the same Conventional Zone Module (FLM-325-CZM4).



Notice!

For mixed applications (pull stations and conventional heat detectors connected to the same FLM-325-CZM4 Conventional zone module) use point type “Fire Auto” and “No delay”.

Alarm Verification Requirement



Warning!

This unit includes an alarm verification feature that will result in a delay of the system alarm signal from a smoke detector. The total delay (control unit plus detector) shall not exceed 60 seconds. No other detector type shall be connected to the circuits unless approved by the Authority Having Jurisdiction.

Use the delay (power-up/start-up) time marked on the label of the smoke detector or on the installed smoke detector(s).

Circuit (Zone)	Delay Time [Seconds]	Detector Module	Detector Delay [Seconds]

Tab. 3.28: Detector delay list

- Remote Programming
 - Remote programming must be manually accepted at the panel onsite
 - Program non-supervisory and supervisory reports for those points used
 - Program trouble reports
 - Set the automatic test report frequency to occur at least every 6 hours
- Timer Programming
 - Program Auto Silence Time for not less than five minutes, or to "0" to disable auto-silence operation
- Point Programming
 - For fire points: open = trouble, latching
- Alarm Output Programming
 - Program the notification appliance circuits (NAC) to activate from the appropriate zone
- Communications Programming (if Used for Central Station Service)
 - Select a communication format that is compatible with the central station, then enable both phone lines

3.7 NFPA Standard-specific Requirements

The FPA-1000 Analog Addressable Fire Panels are designed for use in commercial, industrial and institutional applications and meet the requirements for service under the National Fire Protection Association (NFPA 72) standards outlined in this section.

The minimum system components required for compliance with the appropriate NFPA 72 standard are listed below.

FPA-1000 Analog Addressable Fire Panel	Contains the mainboard, enclosure (back box with dead front door and door), main power supply transformer and power supply.
Batteries	To calculate required battery capacity, download and use the Microsoft Excel based FPA-1000_Battery_Calculator.xls spreadsheet from www.boschsecurity.com .
Initiating Devices	Connected to one of the control panel's Initiating Device Circuits.
Notification Appliances	Connected to the control panel's Notification Appliance Circuits through a control module.

The following additional equipment is needed for compliance with the NFPA 72 standards listed below.

NFPA 72 Central Station Service (Protected Premises Unit) or Remote Station Service

The On-board Digital Alarm Communicator Transmitter (DACT) for connection to a compatible listed Central Station Digital Alarm Communicator Receiver (DACR) or Protected Premises Receiving Unit. This unit must be installed as outlined in *Phone Line Connections (DACT)*, page 70.

NFPA 72 Auxiliary Fire Alarm System

The FPE-1000-CITY City Tie Plug-in Module for connection to a compatible listed Local Energy Municipal Box. This unit must be installed as illustrated in --- MISSING LINK ---.

NFPA 72 Proprietary Fire Alarm System

FPA-1000 alarm, trouble and supervisory relays connected to transmitter(s).

NFPA 72 - 6.9.10.4.1. Survivability from Attack by Fire

One or more of the following means might be considered acceptable to provide a level of survivability consistent with the intent of this requirement:

- Installing a fire alarm system in a fully sprinkler-equipped building in accordance with NFPA 13, Standard for the Installation of Sprinkler Systems
- Routing Notification Appliance Circuits (NACs) separately
- Using short-circuit fault-tolerant Signaling Line Circuits (SLCs) for controlling evacuation signals

3.8

Fire Safety Considerations

No fire detection device or system is 100% incapable of failure.

This fire alarm system can provide early warning of a developing fire. Such a system, however, does not ensure protection against property damage or loss of life resulting from a fire. Any fire alarm system can fail to warn for any number of reasons (such as smoke not reaching a detector that is behind a closed door).



Notice!

The fire alarm system must be tested regularly (when installed, when modified, and at least annually thereafter) to ensure continued performance.

When considering detectors for residential applications, refer to NFPA Standard 72, National Fire Alarm Code.

Having and practicing an escape plan

A fire warning can be wasted unless the personnel plan in advance for a rapid and safe exit from the building.

- Draw a floor plan of the entire building showing two exits from each sleeping area and two from the building. Since stairwells and hallways can be blocked during a fire, provide exits from sleeping area windows. Make copies of the plan and practice it with all personnel.
- Arrange a meeting place outside and away from the building. Once out of the building, all occupants should immediately go to the pre-selected location to be accounted for.
- Provide a barricade between personnel and fire, smoke, and toxic gases (such as closing all sleeping area doors before retiring).
- Instruct children on opening their bedroom windows and exiting safely from the building. If exiting is not possible, then teach them to stay at the open window and shout for help until it arrives.

- If a fire alarm occurs after retiring, then wake the children by shouting to them from behind your closed door. Tell them to keep their bedroom doors closed.
- If the top of your bedroom door is uncomfortably hot, then do not open it. There is most likely fire, intolerable heat, or smoke on the other side. Shout to all family members to keep their bedroom doors closed and to exit the building by alternate routes.
- If the top of the door is not uncomfortably hot, then brace the bottom of the door with your foot and the top with one hand, then open the door about one inch. Be prepared to slam the door shut if there is any pressure against the door or if any hot air rushes in.
- If there is no evidence of excessive heat or pressure, then leave the room and close the door behind you. Shout appropriate instructions to all family members and immediately leave the building by the planned routes.
- If heavy smoke is present, then drop to your hands and knees and crawl to remain below the smoke level.

4 Installing

4.1 Installation Precautions

To avoid incorrect installation and operation, strictly observe the following precautions:



Caution!

Incorrect system operation

Follow all instructions in this manual. Do not deviate.

Comply with all codes and standards set forth by the Authority Having Jurisdiction (AHJ).

Do not assume any installation details not shown in this manual.

Do not alter any mechanical or electrical features of the equipment supplied.



Notice!

Within this document, FPA-1000 refers to both the FPA-1000-UL and FPA-1000-V2. Reference to a complete identifier (FPA-100-UL or FPA-1000-V2) indicates the text applies to only that product/system.

Extent/limitations of synchronization

There are two mainboard NACs on each panel that are synchronized with one another.

Separate panels are not synchronized with each other.

You can add up to four addressable FPP-RNAC-8A-4C NAC power supplies. These remote power supplies provide Aux power and up to 16 synchronized remote NAC circuits. They are not synchronized with the mainboard NACs, but they are synchronized with each other.

Some signaling line devices function as NACs (for example, sounder bases or strobes). The SLC devices that are on the same SLC are synchronized with each other, but they are not synchronized devices on the other SLC nor with the mainboard or RNAC NACs.

4.2 Installation Considerations for UL Listed Systems

Install the control panel according to NFPA 72 for Commercial Fire installations.

Failure to install and program this equipment according to the following requirements voids the listing mark of Underwriters Laboratories, Inc. (UL).

- The standby battery capacity is:
 - Up to 18 Ah at 24 VDC with batteries within enclosure
 - Up to 40 Ah at 24 VDC with batteries in separate battery box
 - Above 40 Ah at 24 VDC with UL Listed external power supply
- The total nominal system current must not exceed:
 - 1.25 A in standby
 - or 4.0 A shared between NAC, Option Bus and AUX power when in alarm
 - or 5.0 A shared between NAC, Option Bus, AUX power, SLC and panel when in alarm
- The control panel must be mounted dry indoors and within a protected area.
- Grounding must be according to Article 250 of the National Electrical Code (NEC) (NFPA 70).
- Points must be connected to UL Listed, compatible devices.
- The ground wire provided with the enclosure must be connected between the door and the enclosure, using the supplied nuts.

When used in UL Listed installations, the control panel must conform to certain programming requirements. Refer to *UL 864 Standard-specific Requirements, page 43*.

4.3 FPA-1000 Fire Panel Components

Components	Fire Panels		
	FPA-1000-V2	FPA-1000-LT	FPA-1000-LC
One mainboard with keypad, display and processor board	X	X	X
One enclosure (lock and two keys)	X	X	
One transformer	X		
One FPE-1000-SLC Signaling Line Circuit Plug-in Module	X	X	
Tabs (one each in English, Spanish and Portuguese) for LED and key text	X	X	X
Wiring labels (in English, Spanish, Portuguese, and Thai)	X	X	
Release Note (in English)	X	X	
Installation and Operation Guide (English)	X	X	X
Operating Instruction Sheet (English)	X	X	
Program Record Sheet (English)	X	X	
General Public License Declaration (English)	X	X	X
Electronic Document Downloads Sheet (multi-language)	X	X	X

Tab. 4.29: Components included with FPA-1000 panels



Notice!

Attach the wiring label onto the inside of the front door.

The Operating Instruction Sheet must be framed and mounted in view adjacent to the fire panel

A second Signaling Line Circuit (SLC), the City Tie Plug-in Module FPE-1000-CITY, and a Networking Card (FPE-1000-NE, FPE-1000-NF, or FPE-1000-NW) can be ordered separately if required.

The FPA-1000-LC (intended as a replacement board) includes the mainboard (-V2 model) with keypad, display and processor board.

4.4 General wiring requirements



Notice!

Shared cable is not recommended for the Option Bus, addressable points bus, telephone, or NAC wiring.

Avoid shielded or twisted-pair wire except for network connections and special applications where a reduced length of wiring (roughly 50%) is acceptable for tolerating a harsh electrical environment.

**Notice!**

All wiring except the battery terminal and primary AC power is power-limited. Power-limited and non-power-limited circuit wiring must remain separated in the cabinet by at least 0.25 in. (64 mm). Primary AC and battery wires must be tied to prevent movement. Power-limited and non-power-limited circuit wiring must enter and exit from the cabinet through different knockouts or conduits.

The length of wire allowed between the control panel and the last device on a wiring run depends on the current drawn on that wiring run. Reducing the number of devices on a wiring run allows the individual runs to be longer.

If not specified, use wire gauge AWG 12 to 18 (ISO 4 mm² to 0.75 mm²).

Circuit Type [Terminals]	Circuit Function	Power Rating / Wire Type / Limitations
AUX [FWR-/FWR+] Full Wave Rectified, non-switched, FWR	Connects to control modules, annunciators and accessories	24 V FWR (17 to 31 V FWR), 500 mA Refer to the manufacturer's installation instructions of the connected device for proper wiring and other limitations AUX power is non-supervised. For proper supervision, use an end-of-line (EOL) power supervision device such as a D275
AUX [RST-/RST+] Resettable, switched and filtered	Connects to 4- wire smoke detectors	24 V DC (17 to 31 V DC), 500 mA Refer to the manufacturer's installation instructions of the connected device for proper wiring and other limitations AUX power is non-supervised. For proper supervision, use an end-of-line (EOL) power supervision device such as a D275
OPTION BUS [Y/G/B/R]	Connects to annunciators and modules	12 V DC, 500 mA Untwisted, unshielded pair, avoid twisted, shielded pair (for maximum wiring distance, see <i>Option Bus</i> , page 67)
NAC 1 [A1-/B1-/B1+/A1+] NAC 2 [A2-/B2-/B2+/A2+]	Connects to NAC devices	Nominal 24 VFWR (17 to 31 VRMS) non-synchronized: 2.5 A per NAC synchronized: 2.75 A NAC 1+NAC 2 in total limited to 4.0 A (shared by NAC, OB and AUX) In alarm, the distance limitation is set by the maximum line drop (use the FPA-1000_Battery_Calculator.xls at www.boschsecurity.com) Refer to the manufacturer's specifications for voltage range

Circuit Type [Terminals]	Circuit Function	Power Rating / Wire Type / Limitations
SLC1 SLC2 (optional) [S1+/SC1-/S2+/SC2-]	Connects to analog addressable SLC devices (as specified in <i>Signaling Line Circuit Devices</i> , page 17)	Nominal 39 V DC (30 to 40 V DC), 260 mA per FPE-1000-SLC Plain wire, avoid twisted, shielded pair, maximum line resistance 50 Ω (for maximum wiring distance, see SLC wiring distances in <i>SLC module</i> , page 61)
City Tie (optional) [ALM-/ALM+] [SUP-/SUP+]	Connects to a Master Box (Local Energy) or Central Station (Reverse Polarity)	Reverse polarity or Local Energy: See <i>CITY TIE module</i> , page 59 Twisted, shielded pair or untwisted unshielded pair, maximum line resistance 65 Ω
RELAY 1/2/3 [NO/C/NC]	Connects to external devices activated or inactivated in defined condition	30 V DC, 5 A / 120 V AC, 10 A
LINE 1/LINE 2	Connects to PSTN (2 lines), RJ45	Telephone cord such as the D162 Dual-modular phone cord
ETHERNET	Connects to Ethernet, RJ45	To connect a computer directly to the panel, use cross-over or straight CAT 5 cable. The FPA-1000-V2 panel supports "auto crossover detection."
BATT [-/+]	Connects to backup batteries	2 x 12 V DC in series 12 AWG 2 x up to 18 Ah maximum (within enclosure) or 2 x up to 40 Ah maximum (external to enclosure)
Network Cards	Allows connection for panel network	Twisted pair (shielded or unshielded), maximum length 2952 ft. (900 m) or CAT 5 cable or better, maximum length 3280 ft. (1000 m) or Multi-mode fiber optic cable with LC connector 62.5 μm /125 μm fiber size and 1300 nm (1270 nm to 1380 nm) wavelength, maximum length 6560 ft. (2000 m) or <10 dB loss

Tab. 4.30: Overview of wiring requirements

4.5 Installing the Enclosure

**Notice!**

Ensure that the environmental conditions of the mounting location comply with the technical specifications listed in *Environmental*, page 108.

Mount to a minimum of 3/8 in. plasterboard (Drywall) with stud spacing less than 24 in. on center. Wall anchors must be used that support at least 110 lb. (50 kg).

Ensure that there is sufficient room to open the cabinet door and dead front door fully, and to easily install, wire and maintain the panel.

The cabinet can be either semi-flush or surface mounted.

Depending on the configuration and the battery selection, the FPA-1000 can weigh more than 55 lbs. (25 kg). When attaching the enclosure to a surface, use mounting hardware (not supplied) capable of supporting this weight, and reinforce the wall as necessary.

Observe position of knockouts for wire entrances - two knockouts on top, one knockout on right side.

**Notice!**

To meet Class A wiring requirements for SLC circuits or network wiring, the outgoing loop and return loop cannot use the same knockout and must remain at least 1/4 in. (6.35 mm) from non-power-limited wiring.

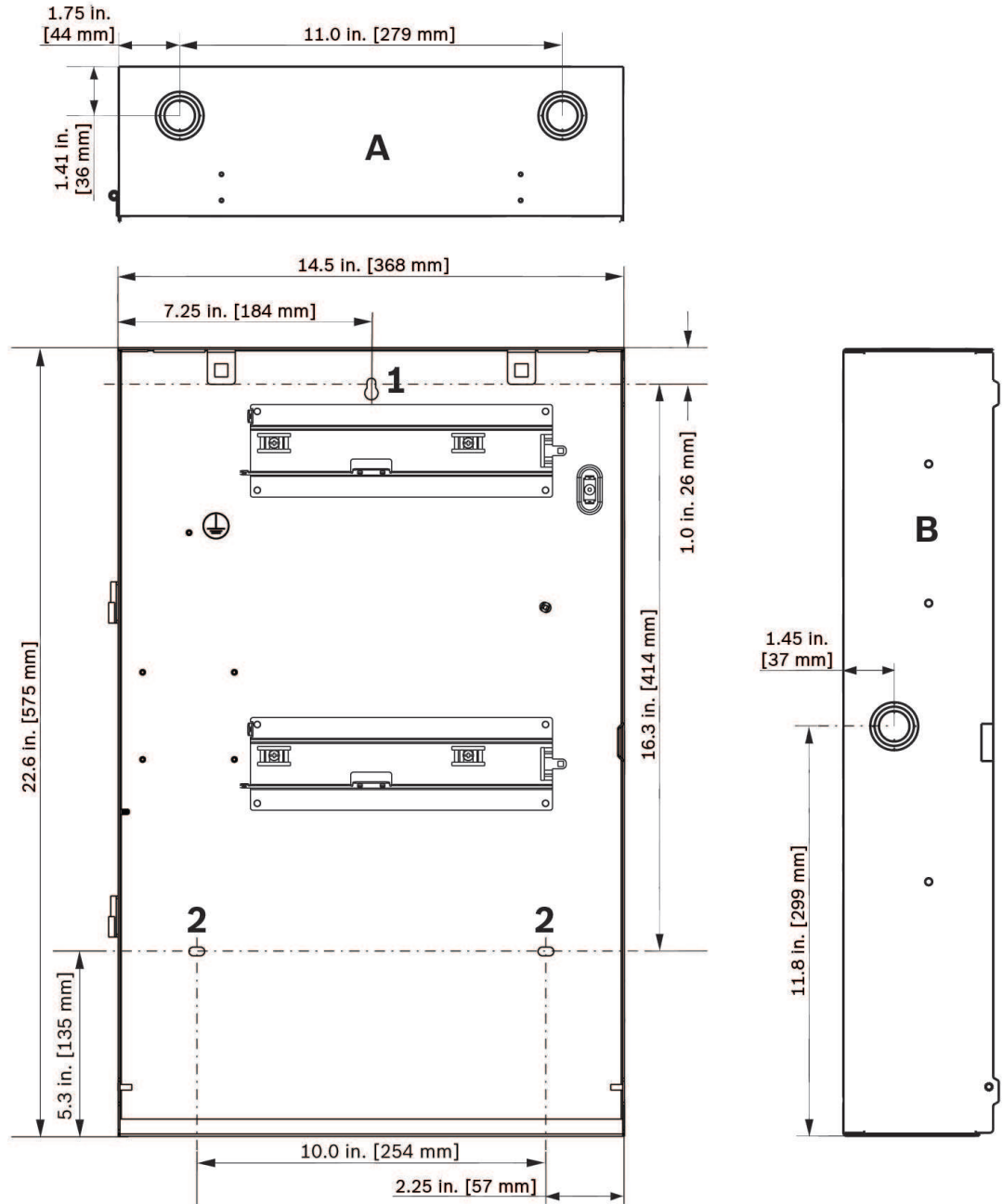

Figure 4.1: Enclosure diagram with dimensions (in inch and mm)

A	Top view, with 2 knockouts	B	Right side view, with 1 knockout
1	Hole, mounting	2	Holes, securing

Surface mounting

The enclosure mounts using one hole mounting located at the top of the back box (refer to Item 1 in the figure above), and two securing holes located in the lower section (refer to Item 2 in the figure above).

1. Using the enclosure as a template, mark the top mounting hole on the mounting surface (refer to Item 1 in the figure above).
2. Start the mounting screw (not supplied) for this hole.

3. Slide the enclosure onto the screw so that the screw moves up into the thinner section of the hole.
4. Tighten the screw.
5. Tighten the two bottom screws.
6. Knock out the desired wire entrances on the enclosure (refer to Items A and B in the figure above).

Semi-flush Mounting with Trim Ring

The FPM-1000-SFMK Semi-flush Mounting Kit includes a trim ring and mounting hardware.

For semi-flush mounting between studs, use the three holes on each side of the enclosure for the screws (refer to Item 1 in the figure below).

Use four screws to fasten the trim ring (refer to Item 2 in the figure below).



Notice!

In a semi-flush mounting of the enclosure, if the screws are over-tightened or the enclosure is set too deep, the trim ring might not fit properly. The sides of the enclosure might need shims to tighten the gap.

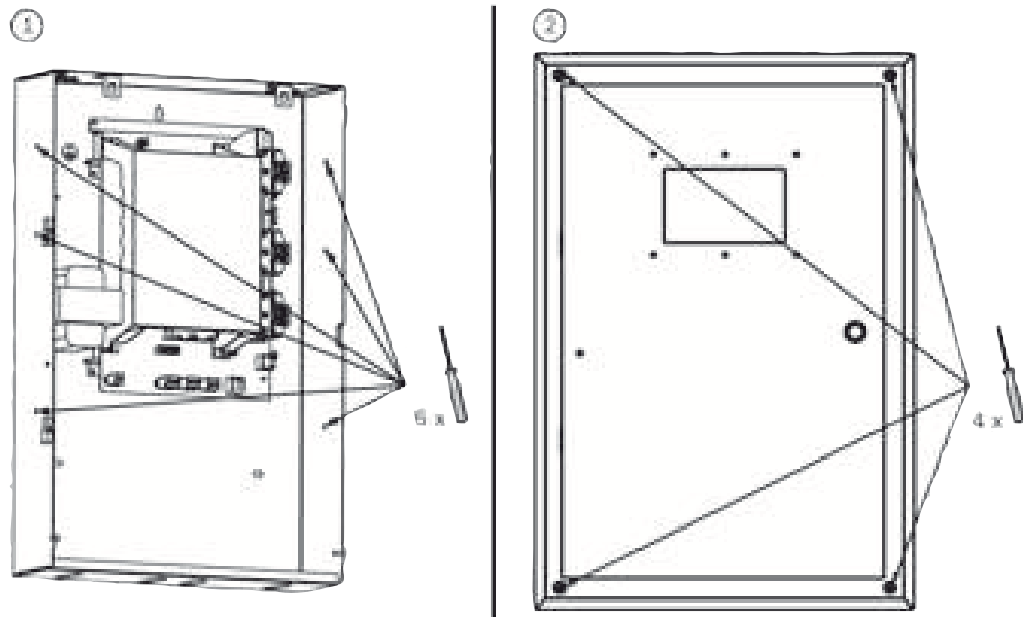

Figure 4.2: Semi-flush mounting with the FPM-1000-SFMK Semi-flush mounting trim ring

Hinging and Unhinging the Door

The control panel comes from the factory with the door attached. For easy wiring, you can unhinge the door (see figure below).

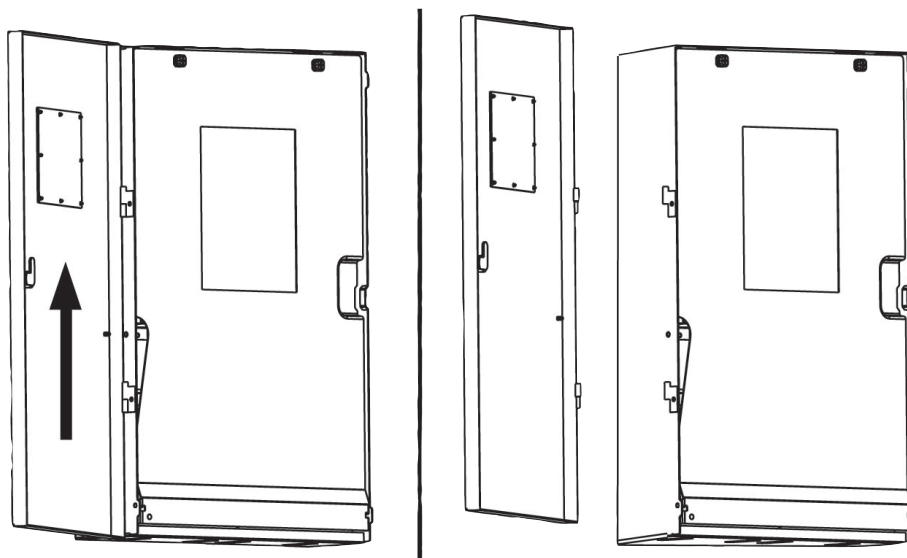

Figure 4.3: Unhinging the door

Dead Front Door

The dead front door covers the electronics and batteries. It can be opened and removed easily. The dead front door is attached at the bottom and secured at the top by fasteners (refer to the following figure). The fasteners close by pushing the fastener head inward with finger pressure (refer to Item A in the figure below) and open with a quarter-turn of the fastener head (refer to Item B in the figure below).

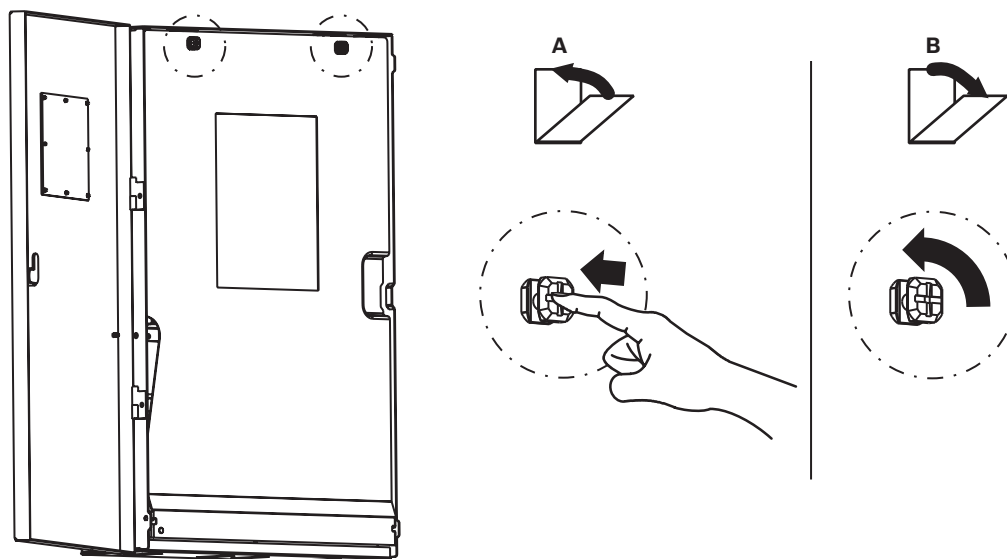

Figure 4.4: Dead Front Door

4.6 Installing the Mainboard



Caution!

Static-sensitive components - ground yourself before handling
 The mainboard and some modules contain static-sensitive components. Use a wrist strap connected to ground or touch ground to discharge static electricity from your body and continue to touch ground while unpacking or handling the mainboard and modules. Run a ground wire to the enclosure before installing the mainboard or modules into the enclosure.

For the location of the enclosure grounding pin, refer to Earth ground connection.

Inserting the Language Tab

For different language versions of LED and key text, use the tabs provided with the control panel.

1. Insert the tab carefully in the slot at the top of the keypad.
2. Slide the tab carefully down until it is completely flush with the keypad.
3. For tab removal, carefully pull upwards at the strap.

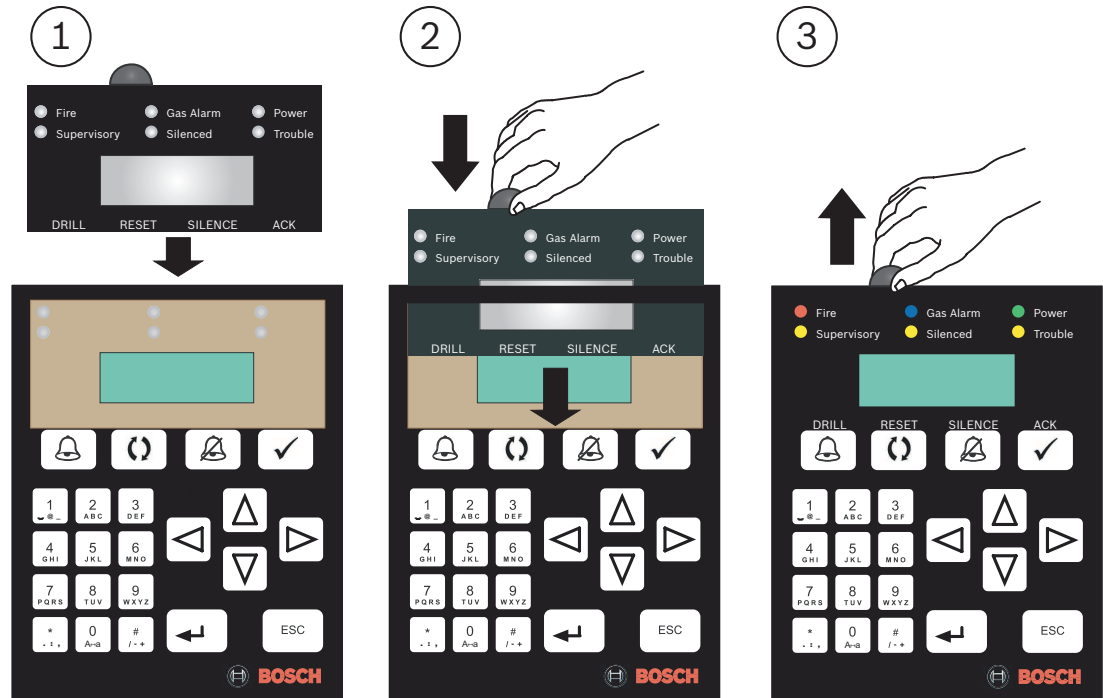

Figure 4.5: Inserting the language tab

Mounting the Mainboard

1. Take the mainboard support out of the accessory bag and place it onto the lower rail as shown in Item 1 in the following figure.
2. Unpack the mainboard including the keypad. Slide the four holes of the mainboard over the support posts (refer to Item 2 in the following figure).
3. Secure the mainboard by tightening the five screws (refer to Item 3 in the following figure).

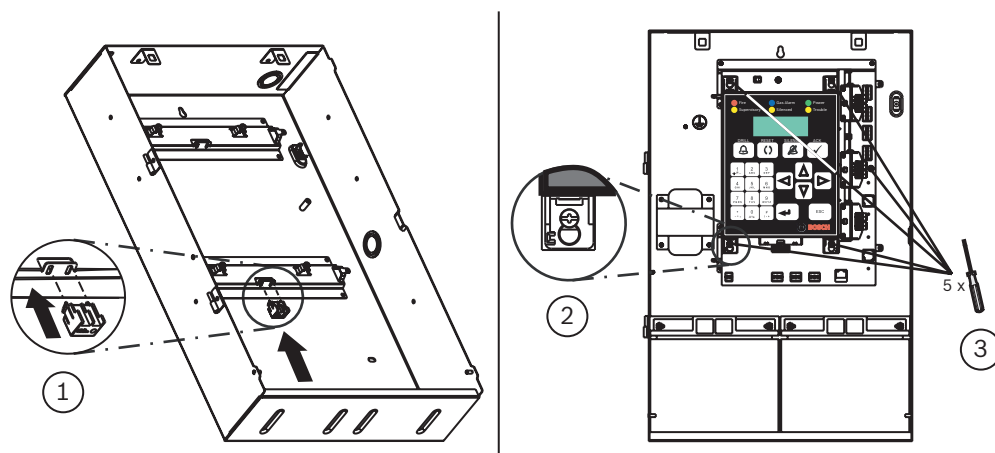

Figure 4.6: Mounting the Mainboard

Ground Wire Connections

When the mainboard is installed, connect the supplied ground wire between the door and the enclosure using the supplied nuts (refer to Item 1 in the following figure). A second ground wire is provided for connecting the ground to the dead front door (refer to Item 2 in the following figure). Both grounds connect to the stud in the enclosure to the left of the mainboard. Refer to the following figure.

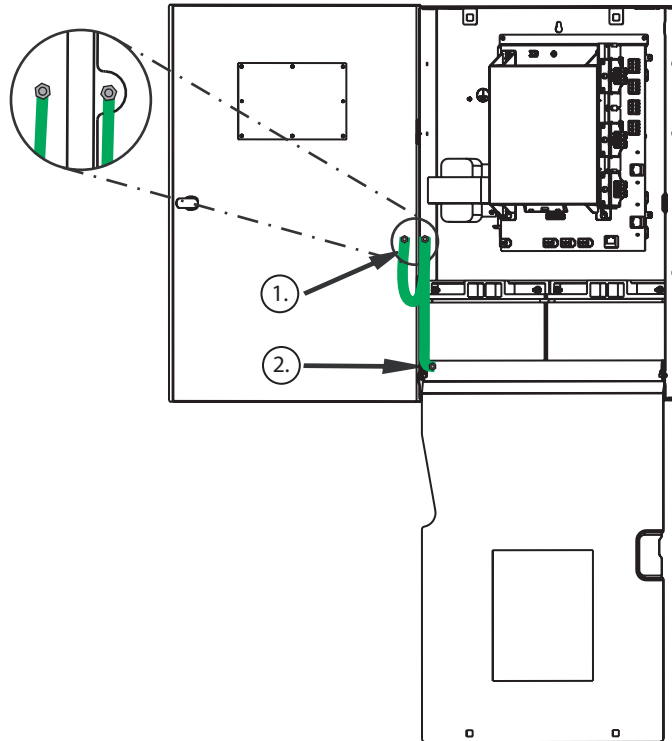

Figure 4.7: Ground Wire Connections

4.7

Installing Optional Plug-in Modules

The mainboard allows for the installation of plug-in modules. The plug-in modules connect directly to the mainboard. They are enabled by programming and supervised by the control panel. See *Mounting plug-in modules*, page 58.

- The first FPE-1000-SLC Signaling Line Circuit is mandatory equipment at the top position on the mainboard
- A second FPE-1000-SLC plug-in module can be installed as an option in the position below the first SLC board
- The position below that for the second SLC module can be equipped with an optional FPE-1000-CITY Plug-in city tie module
- An optional Networking Card can be installed along the bottom of the mainboard

To remove a plug-in module, press the snap-fit hook carefully from left to right and pull the board toward the panel front.

4.7.1 Mounting plug-in modules

Mounting Plug-in Modules



Caution!

Electrostatic discharge - ground yourself using a wrist strap or take other suitable actions. The FPA-1000 mainboard and the plug-in modules have static-sensitive components that could become damaged. Run the ground wire to the enclosure before handling the mainboard or plug-in modules. Touch ground before unpacking and handling the mainboard or plug-in modules. This discharges any static electricity in your body. Continue touching the enclosure while installing the mainboard or plug-in modules.

All three types of plug-in modules are mounted in essentially the same manner. The procedure for mounting an SLC card is given as an example. Note that the City Tie Module and Networking Cards do not have ground wires.

1. Bring the plug-in module into position with the horizontal terminal lettering facing the front side of the control panel. Slide the plug-in module carefully into position (see callout 1 in the following figure)
2. Ensure that the connections seat into the slot properly (see callout 2 in the following figure).
3. Press down softly until the snap-fit hook locks into place (see callout 3 in the following figure).
4. Connect the earth ground wire to the ground stud on the right side of the mainboard (see callout 4 in the following figure).

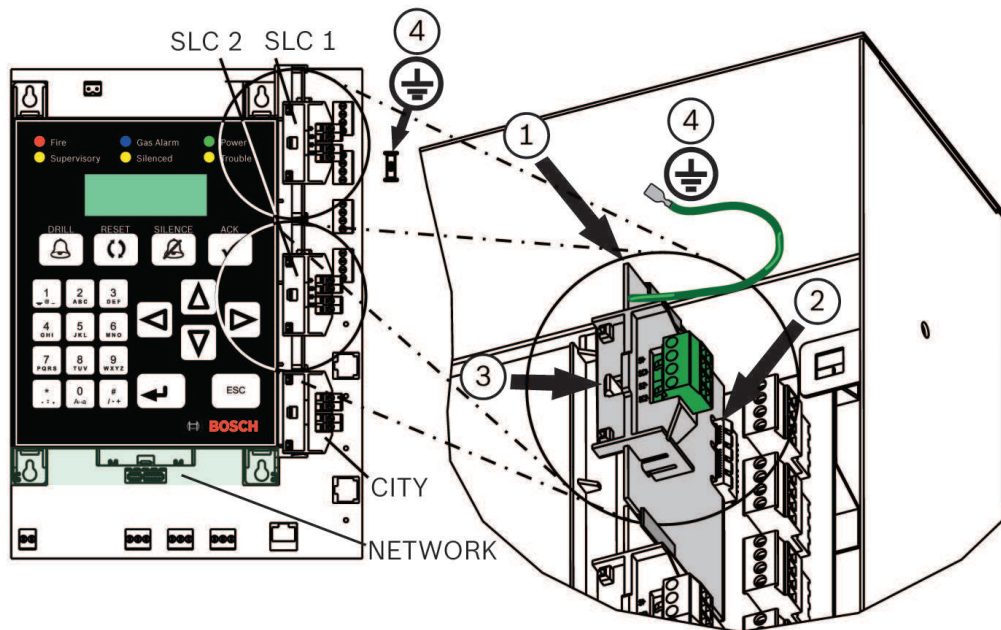

Figure 4.8: Installing plug-in modules - SLC example

SLC1	One SLC module in top position	SLC2	One SLC module in middle position
CITY	One City Tie module in bottom position	NETWORK	One Network Card along bottom of mainboard

1	Plug-in module (SLC in example)	2	Connections (seat into terminal)
3	Snap-fit hook	4	Earth ground wire (SLC only)

4.7.2 CITY TIE module

DIP switch settings



Notice!

Before installing the FPE-1000-CITY module, set the DIP switches on the module to obtain the desired operation mode (Local Energy or Reverse Polarity Mode).

For the location and setting of DIP switches, see the following figure and table.

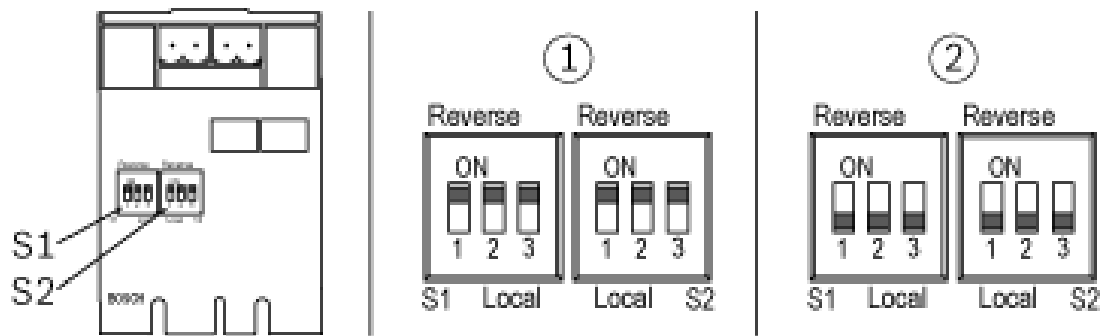

Figure 4.9: FPE-1000-CITY DIP switch setting

S1	Switch 1 Fire Alarm	S2	Switch 2 Supervisory
1	DIP switch setting for Reverse Polarity mode	2	DIP switch setting for Local Energy mode

FPE-1000-CITY	S1 = Fire Alarm			S2 = Supervisory		
DIP switches	1	2	3	1	2	3
Reverse Polarity mode	ON	ON	ON	ON	ON	ON
Local Energy mode	OFF	OFF	OFF	OFF	OFF	OFF



Notice!

You can use different operation modes for the circuits. The DIP switch settings 1 to 3 for each switch (S1 and S2) must be set to the same position.

Connection information

Each circuit can be configured as either Local Energy or Reverse Polarity. Each circuit is individually bypassable and unbypassable. The following panel conditions, activated by the corresponding global zones, can be programmed to activate the City Tie circuit:

- Fire Alarm
- Trouble
- Supervisory
- Gas Alarm

The panel supervises the presence of the City Tie board every 30 seconds. If the City Tie board appears to be missing for three consecutive detections, the panel creates a City Tie board missing trouble.

Observe the maximum circuit resistance of 65 Ω.



Notice!

Use the appropriate DIP switch settings on the module to obtain the desired operation mode.

Reverse Polarity mode

The FPE-1000-CITY City Tie Plug-in Module connects the FPA-1000 fire panel to either a single set or a pair of dual leased telephone company (telco) lines in NFPA 72 Remote Station applications. The City Tie module relays system alarm status information from the control panel to a monitoring station (see the following figure).

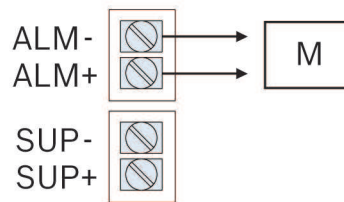

Figure 4.10: City Tie wiring in reverse polarity mode

M	Monitoring station
---	--------------------

In normal conditions, the FPE-1000-CITY sends a steady current to a monitoring station. In an alarm condition, it reverses the polarity of the output current. The module signals a trouble condition by interrupting the output voltage and current.

The default setting is fire alarm for circuit 1 and supervisory for circuit 2.



Notice!

The City Tie module in reverse polarity mode is intended for connection to a polarity reversal circuit of a remote station receiving unit having compatible ratings.

Nominal voltage	24 VDC nominal (26.4 VDC maximum), power-limited, supervised
Output current	33 mA maximum
Supervisory/standby current	5 mA maximum
Circuit resistance	65 Ω maximum
Wire gauge	12 AWG to 18 AWG (ISO 4 mm ² to 0.75 mm ²)
Operating temperature	+32°F to +120°F (0°C to +49°C)
Storage temperature	-4°F to +140°F (-20°C to +60°C)
Relative humidity	≤93%, non-condensing

Tab. 4.31: Specifications reverse polarity mode

Local Energy mode

The City Tie Plug-in Module connects local energy signaling devices to the FPA-1000 for auxiliary service operation. The devices are connected in series.

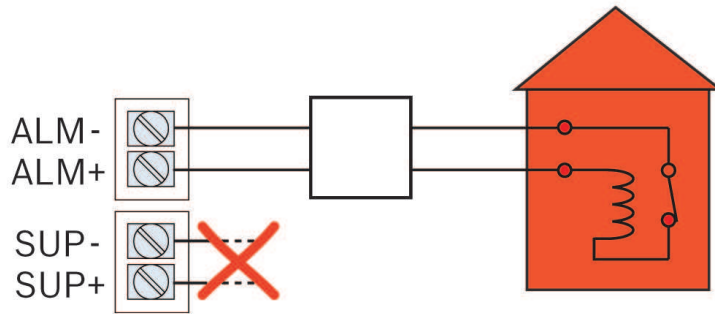

Figure 4.11: City Tie wiring in local energy mode

Type of connection	In series
Alarm, trip coil	24 VDC (momentary into 14.5 Ω coil)
Alarm current	250 mA DC (momentary, ≤1 ms)
Supervisory/standby current	<50 mA DC
Trip coil resistance	14.5 Ω
Nominal coil voltage	3.65 VDC, power-limited, supervised
Circuit resistance	65 Ω maximum
Wire gauge	12 AWG to 18 AWG (ISO 4 mm ² to 0.75 mm ²)
Operating temperature	+32 °F to +120 °F (0 °C to +49 °C)
Storage temperature	-4 °F to +140 °F (-20°C to +60°C)
Relative humidity	≤93%, non-condensing

Tab. 4.32: Specifications local energy mode



Notice!

The shunt connection is recognized only as a supplementary signaling unit as part of a local control unit and is not recognized as an auxiliary control unit connection per NFPA 72.

For listing of compatible Gamewell devices, see *Plug-in Modules*, page 14.

4.7.3

SLC module

The Signaling Line Circuit is power-limited and supervised.

Signaling line circuits can be wired as Class X, Class A, or Class B circuits. When using Class X wiring, either Analog isolator bases (FAA-440-B4-ISO or FAA-440-B6-ISO) must be used for each analog addressable device on the SLC or the FLM-325-ISO Short circuit isolator for FPA-1000 must be installed before and after each analog addressable device on the SLC. The wiring from the control panel to the first FLM-325 ISO-and from the last FLM-325-ISO back to the control panel must be in conduit. For more information on circuit capabilities and structure, see signaling line circuits in *NFPA 72*.

For UL 864 programming requirements, see *UL 864 Standard-specific Requirements*, page 43.

Consider requirements according to *NFPA 72 - 6.9.10.4.1. Survivability from Attack by Fire*, page 46.

SLC specifications

Voltage	Nominal 39 VDC (30 to 40 VDC), power-limited, supervised
Current (alarm)	1 A maximum shared between panel and the SLCs Panel ≤ 250 mA SLCs = 60 mA/card + 220 mA/loop maximum
Circuit resistance	< 50 Ω
Circuit capacitance	< 1 μF
Circuit inductance	< 1 mH
Configuration	1 Class X or Class A, or 1 or 2 Class B

Tab. 4.33: SLC specifications

SLC wiring distances

For the SLC wiring, the following maximum permissible values apply:

- Wiring resistance on the SLC must be less than 50 Ω.
- Circuit capacitance must be less than 1 μF.
- Circuit inductance must be less than 1 mH.
- The total wire length of all branches connected to one FPE-1000-SLC module (terminals S1+/SC1- and S2+/SC2-) must not exceed 30,000 feet (9140 m) for Class B. See the following figure.

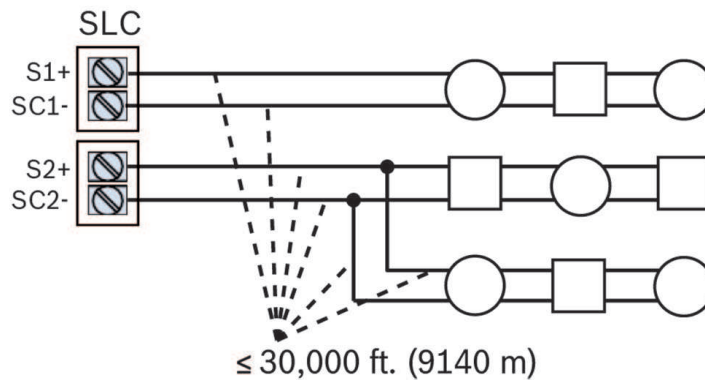

Figure 4.12: Total length for SLC Class B wiring

- The maximum distance an analog addressable detector or module is allowed to be located from the control panel (for Class X, Class A, or Class B SLC) is limited depending on the wire gauge. See the following table.

Wire gauge	Maximum wiring distance
12 AWG (ISO 4 mm ²)	10000 ft. (3050 m)
14 AWG (ISO 2.5 mm ²)	10000 ft. (3050 m)
16 AWG (ISO 1.5 mm ²)	6200 ft. (1890 m)
18 AWG (ISO 0.75 mm ²)	3900 ft. (approx. 1189 m)

Tab. 4.34: Maximum wiring distances for SLCs

Addressing SLC devices

Before installation, all of the addressable devices installed on each of the SLCs must be programmed with a unique address. The analog sounder bases derive their address automatically from the detector attached to them. The Analog Sounder Base address has the detector address plus 127.

Example: The detector address is 36. $36 + 127 = 163$. The Analog Sounder Base has an address of 163.

This address is what the FPA-1000 control panel uses to identify each addressable device and control its functionality. All listed addressable devices come from the factory preset to address 127. This preset address can only be reprogrammed using the D5070 Analog Device Programmer.

Devices must not be powered when using the D5070 Analog Device Programmer to set addresses. The FLM-325-IM Contact Module should not be connected to the SLC when using the D5070 Analog Device Programmer to set addresses.

Follow these instructions to set or reprogram the address.

1. Identify each analog addressable device that will be installed on an SLC
2. Label each device with a unique address, ranging from 1 to 127 or 1 to 254 (see *SLC Address Assignment*, page 38).
3. Using the D5070 Analog Device Programmer as shown in the following figure, program the appropriate address into each analog addressable device.

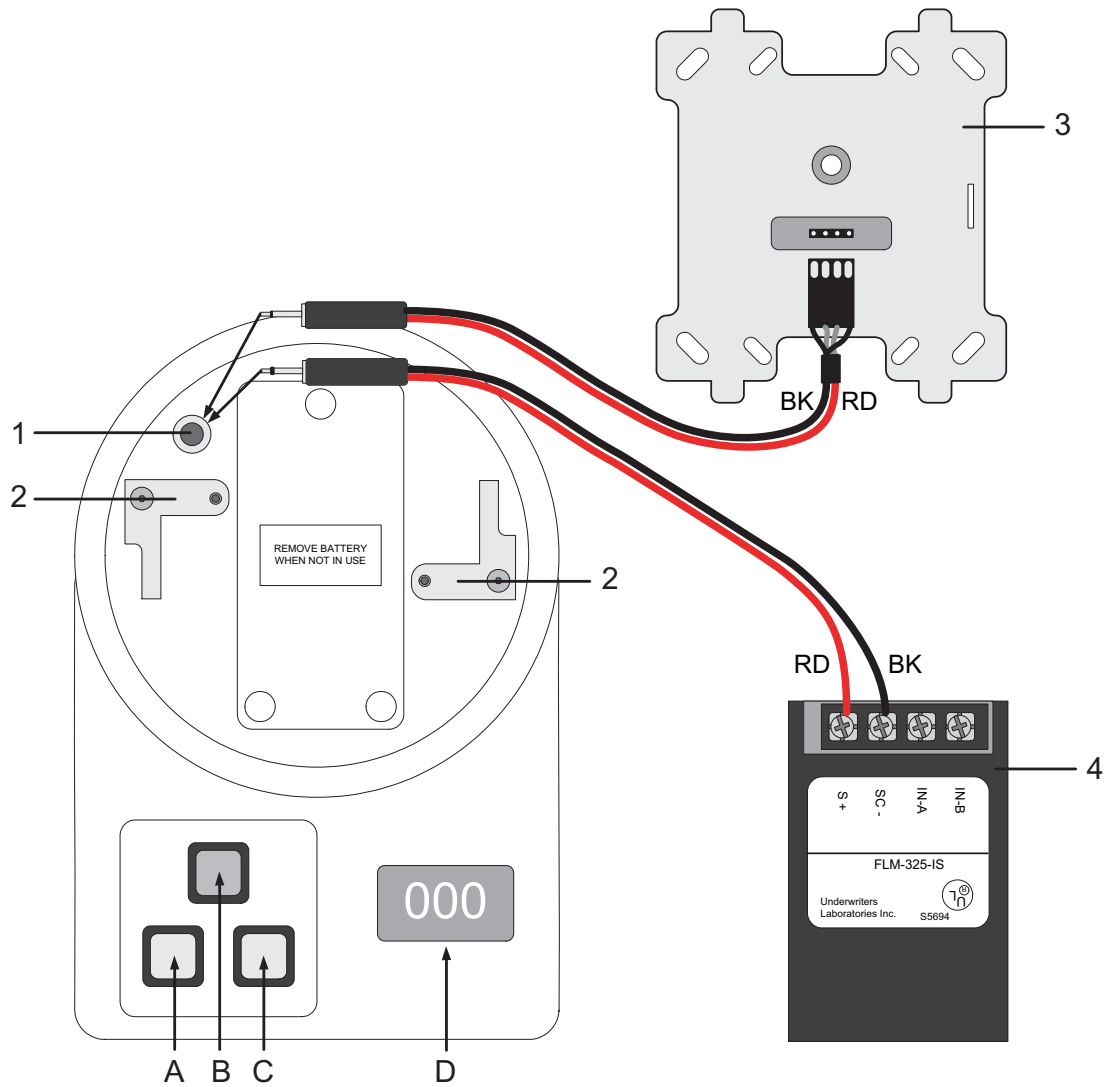

Figure 4.13: Addressing devices with the D5070 programmer

1	Remote programming jack	2	Programming base for detector heads
3	Addressable module 4-in. back box type with module adapter, plug non-polarized	4	Addressable module single-gang back box type with module adapter
A	Power on / display current address / increase address by 10	B	Store displayed address into detector
C	Power off / increase address by 1	D	Display of device's address (or the detector's analog value)
RD	Red	BK	Black

4.7.4

Network Connections

Network card types

There are three types of network cards available for interconnecting FPA-1000-V2 panels into a network. For specifications on these cards, see the following table.

Card Type Number	Description	Connector Type	Maximum Distance
FPE-1000-NE	3 Ethernet ports	CAT 5 minimum	328 ft. (100 m)
FPE-1000-NF	1 Ethernet port, 2 fiber optic ports	LC connector, 62.5 μm/125 μm fiber size 1270 nm to 1380 nm wavelength multi-mode fiber optic	10 dB loss or 6560 ft. (2000 m)
FPE-1000-NW	1 Ethernet port, 2 wired ports	Twisted pair wire (shielded or unshielded)	2952 ft. (900 m) maximum; actual length depends on wire quality
		CAT 5 cable (shielded or unshielded)	3280 ft. (1000 m) maximum

Network circuit styles

Network connections can be made as Class X or Class B circuits. The network circuit is supervised.

Class X configuration is recommended because this allows the panels in a network to communicate with each other, ensuring circuit operation in the event of a single break in the wiring.



Notice!

The network cards have built-in isolators automatically making the Class A loop connecting the networked panels into a Class X circuit.

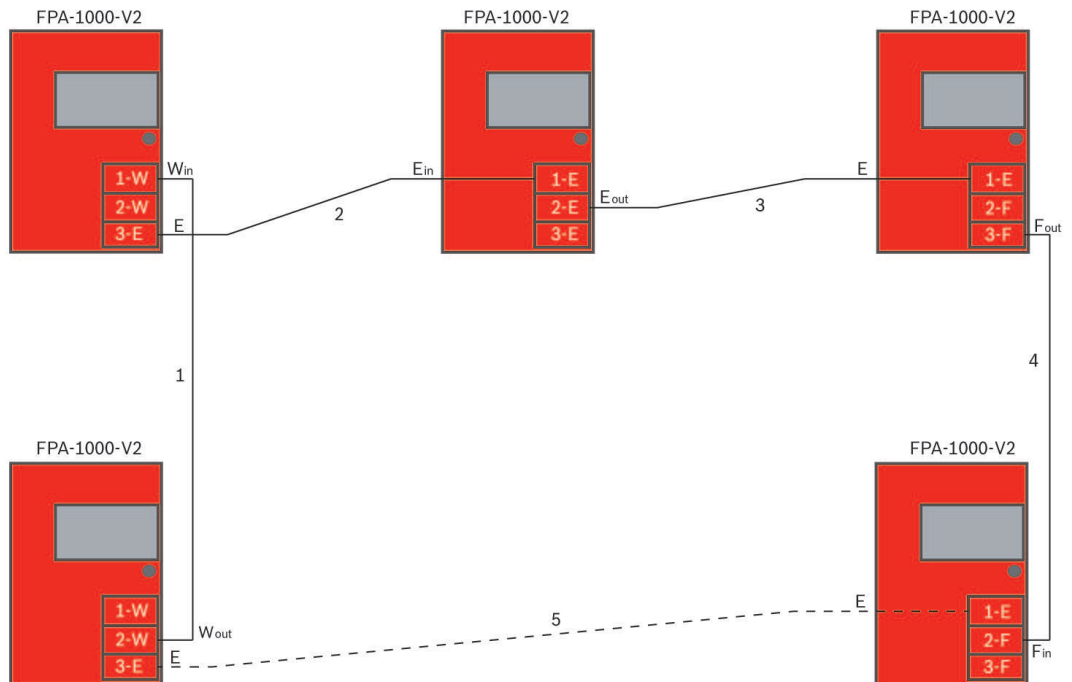

Figure 4.14: FPA-1000-V2 network connections example

1	FPE-1000-NW wired card (Port 2 Wire out) to FPE-1000-NW wired card (Port 1 Wire in) connection	2	FPE-1000-NW wired card (Port 3 Ethernet) to FPE-1000-NE Ethernet card (Port 1 Ethernet in) connection
3	FPE-1000-NE Ethernet card (Port 2 Ethernet out) to FPE-1000-NF Fiber Optic card (Port 1 Ethernet) connection	4	FPE-1000-NF Fiber Optic card (Port 3 Fiber out) to FPE-1000-NF Fiber Optic card (Port 2 Fiber in) connection
5	FPE-1000-NF Fiber Optic card (Port 1 Ethernet) to FPE-1000-NW Wired card (Port 3 Ethernet) connection		
Note: If any one connection (for example, connection 5) between two panels is removed, the existing Class X circuit becomes a Class B circuit.			

Additional notes regarding Class X:

1. No T-taps allowed on Class X network wiring.
2. The return side of the loop must be routed separately from the outgoing loop.
3. The return side must not share the same conduit or cable as the outgoing side of the loop.
4. Refer to NFPA 72 for additional requirements of Class X circuits.

Network ground-fault detection



Warning!

Ground fault!

The network cards have built-in ground fault detection. The ground fault detection is located at Port 1 on all three cards. It is also on Port 3 on the FPE-1000-NW card. For proper detection, ground fault detection must be connected at only one end of each connection.

For more detailed information, see *Ground Fault Detection*, page 23.

4.8

Control Panel Terminal Connections



Danger!

Explosion and burn hazard. Do not short terminals.

Incorrect connections can result in damage to the unit and personal injury.

Before servicing this equipment, remove all power including AC, battery and phone lines.

For maximum circuit wiring distance, see module sections for the specific circuit type.

Wiring Road Map

For locations of areas of non-power-limited (A, red) and power-limited (B, green) wiring, see the following figure.

The enclosure provides three knockouts: two at the top for power-limited and non-power-limited connections, and one on the right side for non-power-limited connections.

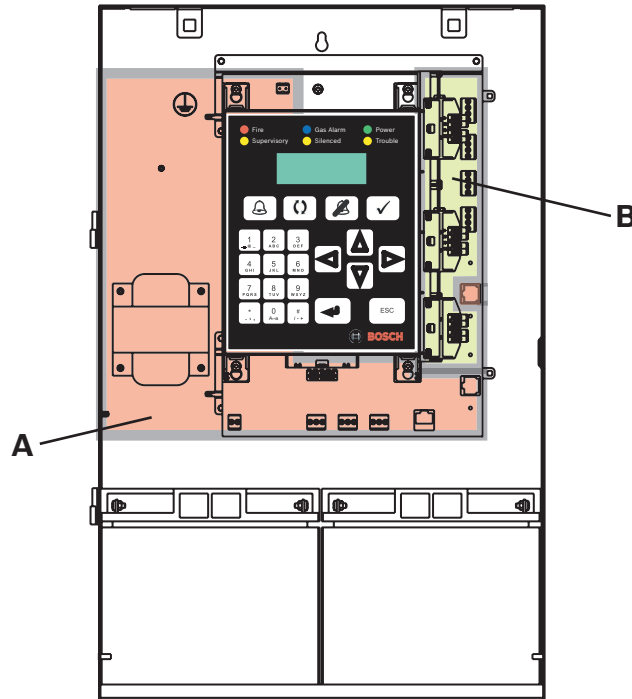

Figure 4.15: Wiring Road Map

4.9 Option Bus

Use four-conductor, 18 AWG (ISO 0.75 mm²) or larger wire to connect Option Bus devices to the FACP. For additional information, see .

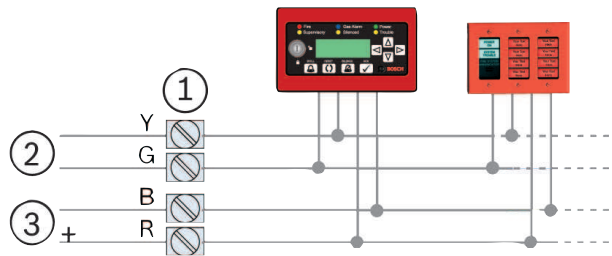

Figure 4.16: Option bus wiring

1	Option bus terminals	2	DATA (yellow and green wires)
3	POWER (black wire = Common, red wire = +12 V)		

Protocol	Bosch option bus protocol
Voltage	12 VDC nominal, power-limited, supervised
Current	500 mA maximum
Configuration	One Class B
Circuit wiring distance	4000 ft. (1219 m) maximum, depending on cable gauge and connected devices

Tab. 4.35: Option bus specifications

4.10 NACS

The control panel provides two Class A or two Class B notification appliance circuits (NACs).

For compatible notification appliances, see the *FPA-1000 NAC Compatibility List* (P/N F.01U.075.636).

Consider requirements according to NFPA Standard-specific requirements, in particular, see *NFPA 72 - 6.9.10.4.1. Survivability from Attack by Fire, page 46.*

4.10.1

NAC wiring

For the configuration and wiring of Class A and Class B NACs on the mainboard, see the following figure.

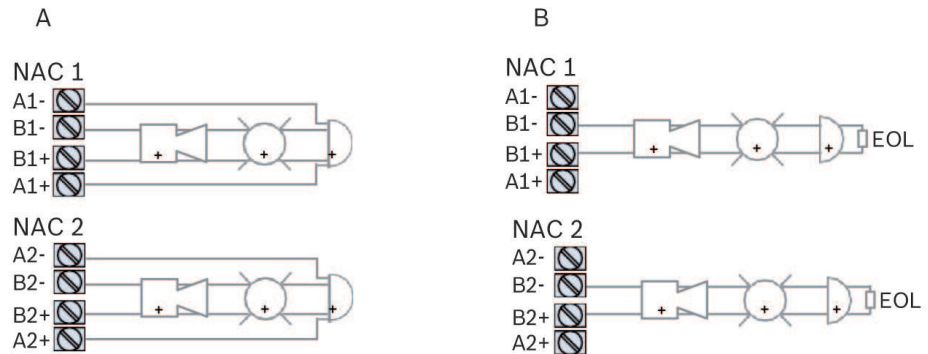

Figure 4.17: NAC wiring - Class A and Class B

A	Class A wiring	B	Class B wiring ¹
1 For Class B termination, use Bosch EOL 2.2 kΩ (F.01U.034.504)			

4.10.2

NAC specifications

Mainboard	2 circuits (NAC 1 and NAC 2)
NAC power from panel	Nominal 24 VFWR (17 to 31 VRMS), regulated, power-limited, supervised
Line impedance	1.45 Ω maximum
Maximum load	Non-synchronized - NAC 1 - 2.5 A and NAC 2 = 2.5 A Synchronized - NAC 1 + NAC 2 in total = 2.75 A Maximum current limited by overall 4.0 A shared among AUX power, Option bus, and NAC
Configuration	Two Class A or two Class B
Selectable patterns	Steady Pulsing Temporal Code 3 Temporal Code 4 Wheelock System Sensor Gentex
Options	Up to 4 FPP-RNAC-8A-4C, providing 16 NAC lines

Tab. 4.36: NAC specifications

See UL 864 Standard-specific requirements

For programmable options that meet UL requirements, see UL 864 Standard-specific requirements.

4.10.3 Synchronicity

For information on notification appliance synchronicity, see and the table below.



Notice!

To be UL 864 compliant, use only the notification devices listed in the *FPA-1000 NAC Compatibility List*.

For the number of NAC devices allowed when using synchronized products from the indicated manufacturers, see the following table:

Manufacturer	Maximum devices per NAC
Wheelock	27
System Sensor	25
Gentex	23

These are the maximum number of devices. A high-current setting reduces this quantity.

4.11 Mainboard Relays

The three Form C relays are programmable The default selection for the relays is:

- Relay 1 to indicate global alarm (zone 129)
- Relay 2 to indicate global system trouble (zone 130)
- Relay 3 to indicate global system supervisory (zone 131)

By programming them to up to five of the zone numbers described for point and zone mapping, the zones can be programmed to activate the relays on a variety of conditions. In addition, programming as gas alarm is selectable.

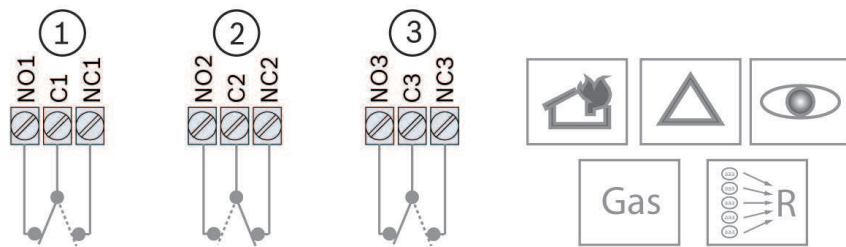

Figure 4.18: Mainboard relays

All relay outputs in the system have an “Energized on normal” option. This option provides fail-safe features so that a relay transition from energized to de-energized can be supervised. If the “Energized in normal” option is enabled, the relay is turned on for deactivation operation. Upon activation operation, the relay is turned off. If this option is programmed as “Not energized”, the relay is turned on for activation and turned off for deactivation.

The default programming for Relay 2 is trouble and energized in normal.

Mainboard relays	Three Form C relays, individually programmable as alarm, trouble, supervisory, gas alarm or activation by zone. Rated at 5 A, 30 VDC/10 A, 120 VAC, not power-limited, resistive loads only.
Optional devices	D7035/B Octal relay modules, 8 Form C outputs, two units maximum with 8 relays each

4.12 Phone Line Connections (DACT)

Phone lines are power-limited and can be programmed to be supervised (see).

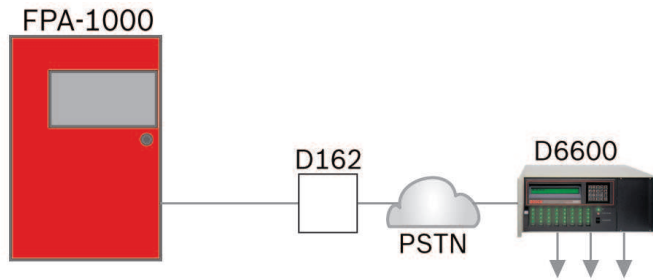

Figure 4.19: PSTN connection

Telephone Cord Installation

Use a telephone cord (for example D162 Modular Telephone Cord) to connect the primary phone line to the Line 1 RJ45 jack at the bottom of the FPA-1000 mainboard. Use another telephone cord to connect the secondary phone line to the Line 2 RJ45 jack.



Notice!

For all applications, connect separate primary and secondary phone lines to the FPA-1000.

To prevent jamming of alarm and other reports, wire and locate the RJ31X jack so that normal telephone use is temporarily interrupted while the FPA-1000 transmits data (see the following figure). After installation, verify that the FPA-1000 seizes the phone line.

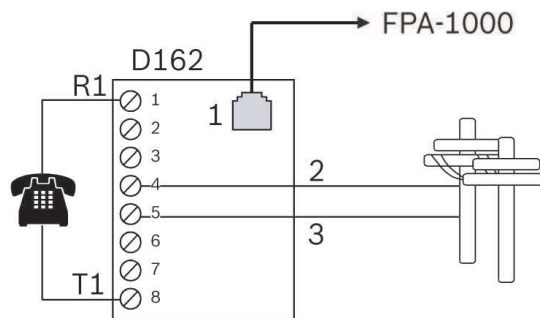

Figure 4.20: D162 phoneline wiring

1	D162 (or equivalent) telephone cord connection to the FPA-1000 panel	2, 3	Telco lines - 2 = ring, 3 = tip
T1	House telephone tip	R1	House telephone ring

Do not connect registered equipment to party lines or coin-operated telephones. If the local telephone company requests notification before you connect the FPA-1000 to the telephone network, provide the following information:

- Which line you are connecting to the Digital Alarm Communicator Transmitter (DACT)
- Make, model, and serial number of the device
- FCC registration number (US:ESVAL00BFPA1000)

If the telephone company changes its communications facilities, equipment, operations, or procedures that can affect the performance of the FPA-1000, the telephone company is obligated to notify the user in writing.

4.13 Ethernet Connection

Ethernet connection is power-limited. Monitoring the Ethernet is programmable. For a general system connection of the fire panel to a host PC, see the following figure.

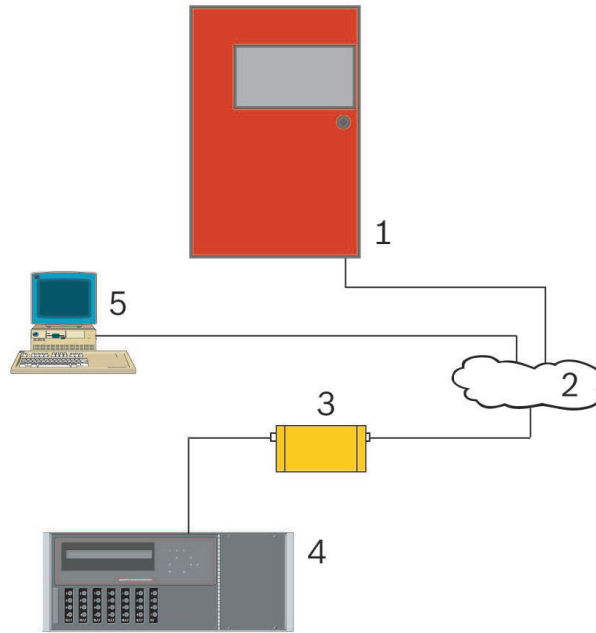

Figure 4.21: Ethernet connection

1	Fire panel	2	Ethernet/Internet
3	ITS-D6686-UL Receiver Ethernet adapter	4	D6600 Central station receiver, 32-line
5	Host PC running a web browser	1-2-3	Ethernet network to the ITS-D6686-UL connection
3-4	ITS-D6686-UL to D6600 COM4 port connection	2-5	Ethernet network to host PC Ethernet network interface card (NIC) connection

4.14 Power Supply Wiring

The FPA-1000 allows for charging up to 40 Ah of batteries with the provided transformer working with 120 V AC or 240 V AC.

For installations requiring battery capacity higher than 40 Ah, a regulated and UL 1481 Listed external power supply can be used. The external power supplies connect through the panel's battery terminals and are supervised for AC and battery fault by an Input Module (for example FLM-325-2I4) on the SLC.

4.14.1 AC Power Connection



Notice!

NFPA 72 requires that the AC connection is made from a mechanically protected dedicated branch circuit. The circuit must be marked in red and identified as a “FIRE ALARM CIRCUIT”. The location of the circuit and its disconnecting means must be permanently noted at the fire alarm control panel. The circuit breaker must be rated at 20 A maximum.

Main power supply (primary)	
Supervision	Supervised for the presence of AC power
Voltage	120 V AC, 60 Hz, 1.1 A maximum (black/white wires) 240 V AC, 50 Hz, 0.6 A maximum (yellow/white wires)

1. Connect the primary side of the transformer (see the following figure):
Black and white wires to unswitched 120 V, 60 Hz, or
Yellow and white wires to unswitched 240 V, 50 Hz circuit.
2. Use wire nuts for connections. Place a wire nut over the unused black or yellow wire.

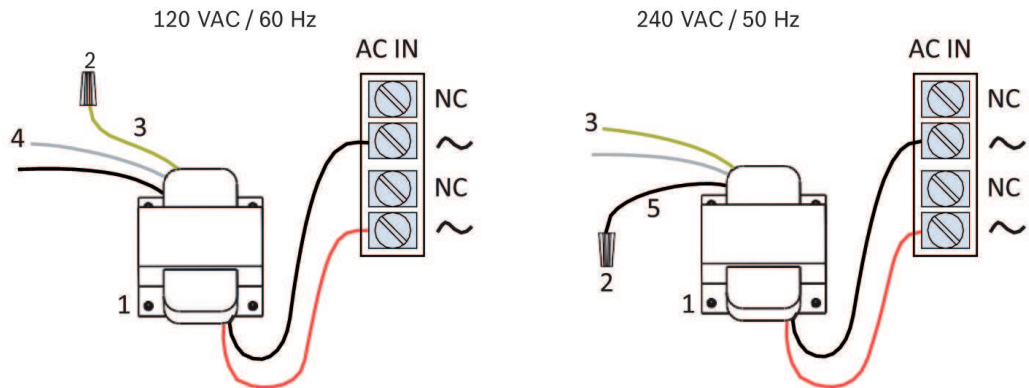

Figure 4.22: Connecting AC power

1	Transformer	2	Wire nut
3	Yellow wire - 240 VAC line voltage	4	White wire – 120/240 VAC neutral voltage
5	Black wire – 120 VAC line voltage		

3. Connect the earth ground to the threaded ground stud on the left side of the enclosure (see the following figure):

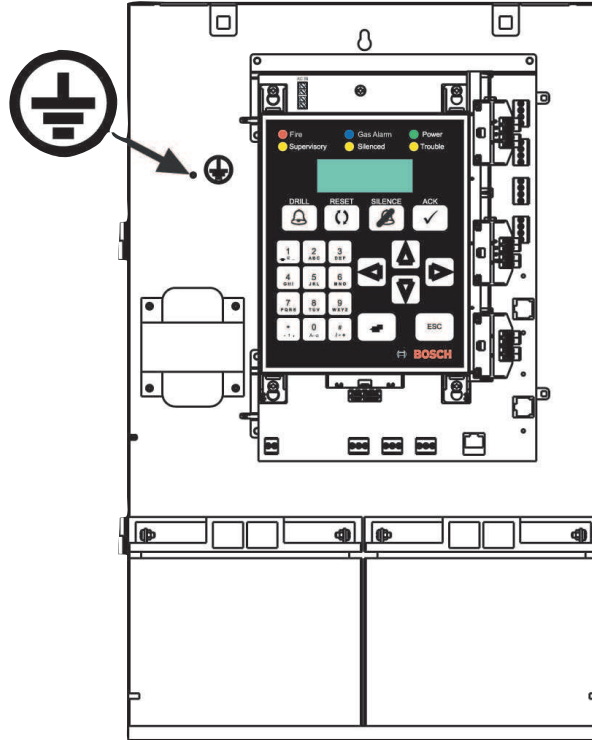

Figure 4.23: Earth-ground connection

4.14.2

Battery Connection



Danger!

Explosion and burn hazard

To minimize the risk of a battery explosion and possible burns to your person, do not short the battery terminals.



Caution!

The batteries contain sulfuric acid. The acid may cause damage of the skin and eyes and destroy fabrics. If contact is made, flush affected area with water for 15 minutes, remove contaminated clothing, and seek medical attention.

This product requires two 12 V batteries in series for a combined voltage of 24 V. The rechargeable battery circuit is supervised for the presence of battery power.

To select the proper battery size for your system, use the Microsoft Excel based spreadsheet (FPA-1000 Battery Calculator.xls). The spreadsheet is can be downloaded at www.boschsecurity.us.

Select batteries that meet or exceed the total capacity calculated.

Example 1:

If your system requires a battery capacity of 12 Ah/24 V, you need two batteries of 14 Ah/12 V.

Example 2:

If your system requires a battery capacity of 30 Ah/24 V, you need two batteries of 38 Ah/12 V. Two batteries larger than 18 Ah will not fit in the FPA-1000 enclosure. You will need to put the batteries into a remote enclosure.

**Notice!**

A calculated required battery capacity over 40 Ah is not allowed. Either reduce the existing load or add an external regulated fire-protective signaling power supply.

For information on external power supply use, see External power supply.

**Notice!**

Use only batteries from same manufacturer and with the same capacity. **Do not mix batteries!**

For recommended battery manufacturers, see the following table:

Manufacturer	Batteries
POWER SONIC	PS-1270, PS-12170, PS-12180
YUASA	NP7-12, NPG18-12

**Notice!**

Do not connect the interconnect cable until the system is completely installed.

Observe the wiring polarity and connect the battery cables to the BATT terminals on the mainboard. Use only batteries of the same capacity rating (Ah). Connect batteries in serial. See the following figure:

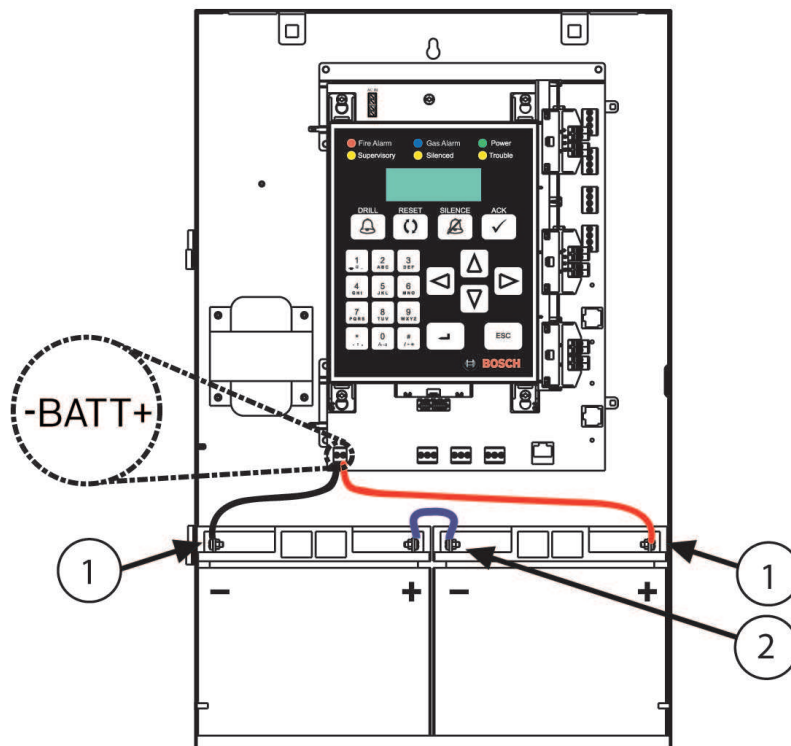

Figure 4.24: Connecting backup batteries

1	Positive (+) battery terminal connection to panel	2	Interconnect cable connecting the batteries in series
3	Negative (-) battery terminal connection to panel		

Using a remote enclosure

Mount a BATB-40 or BATB-80 Battery Boxes on the left side of the FPA-1000. For information on mounting the Battery box, see the *BATB-40/BATB-80 Installation Instructions*. Connect the wires running from the batteries to the FPA-1000 battery terminals (see the following figure):

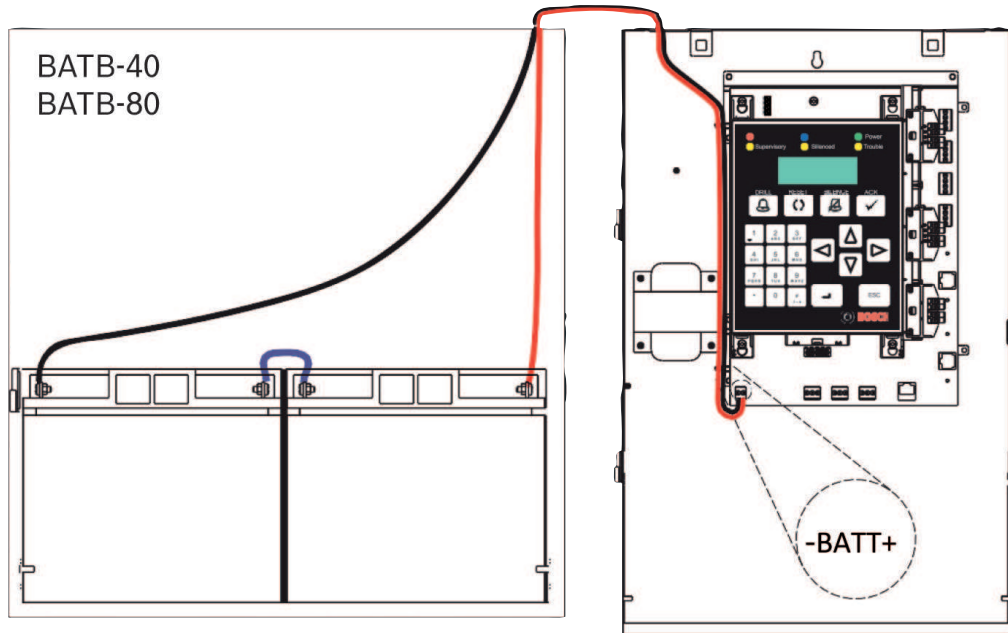

Figure 4.25: Connecting backup batteries from a remote enclosure

Power supply (secondary) with battery backup	
Battery capacity in cabinet	7.0 Ah minimum, 40 Ah maximum
Battery capacity in remote battery box	7 Ah or 18 Ah 24 Ah or 38 Ah
Battery charge current	2.0 A maximum
Battery maintenance	Perform a battery load test (Pass/Fail) at least twice per year. Replace batteries that fail the test. Battery voltage should be ≥ 26 V.
Current consumption	

Power supply (secondary) with battery backup	
In alarm 1.0 A maximum shared between panel and SLC(s) 4.0 A maximum shared among NAC, Option Bus, and AUX power	5 A maximum Panel ≤ 250 mA SLCs = 60 mA/card + 220 mA/loop maximum NACs Unsynchronized NAC 1 and NAC 2 = 2.5 A maximum each Synchronized NAC 1 + NAC 2 in total = 2.75 A maximum Option Bus = 0.5 A maximum AUX/FWR = 0.5 A maximum AUX/RST = 0.5 A maximum
Fuses	Blade type, 15 A
Supervision	Supervised for the presence of battery power or low voltage
Voltage	24 VDC

Tab. 4.37: Battery circuit specifications

4.14.3

Auxiliary Power Connection

On the mainboard, 24 VDC auxiliary power is available to run expansion boards or other low current auxiliary devices. Any devices powered from the auxiliary power terminals should be considered when determining standby battery size. The devices connected must have a wider operating voltage range than 17 V to 31 V. Observe that one output is DC and the other is FWR. The AUX power outputs are power-limited.



Notice!

Auxiliary power is not supervised. Therefore, be sure to use a supervision module when connecting four-wire smokes or other devices without built-in supervision.

AUX FWR (full wave rectified)	500 mA at 24 VFWR (17 VRMS to 31 VRMS) non-switched, power-limited, unfiltered, non-supervised, special application
AUX RST (resettable)	500 mA at 24 VDC (17 VDC to 31 VDC) switched, power-limited, filtered, non-supervised, special application
Battery backup	Yes

Compatibility and number of devices to be connected

AUX connection	Device	Quantity
FWR	FAA-325-B6S Analog sensor base w/ sounder, 6in	25
RST	FAD-325-R Analog duct smoke head, 2-wire 24V or FAD-325-V2F-R Kit, analog duct housing w/relays & head	9

4.14.4 External Power Supply



Caution!

Before connecting the external power supply, disconnect the transformer from the AC terminals.

For installations requiring battery capacity higher than 40 Ah, use a regulated and UL 1481 Listed external power supply. The external power supply connects through the panel's battery terminals. Batteries and battery charger are not supervised. For supervision of AC and battery fault use an Input Module (for example FLM-325-214) on the SLC (see the following figure).

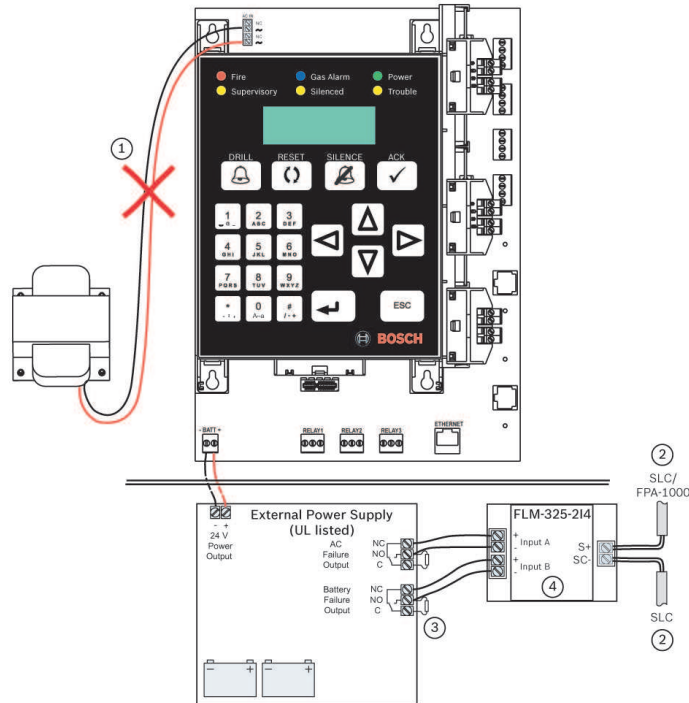

Figure 4.26: Connecting external power supply & Dual input monitoring module

1. Disconnect the transformer from the AC terminals (see item 1 in the figure above)
2. Connect S+/SC- terminals of the Dual Input Monitor (FLM-325-214) to the SLC:
Connect either side to the next device on the SLC or
One side to the FPE-1000-SLC Plug- In Module of the FPA-1000 and the other side to the next device on the SLC (see item 2 in the figure above)
3. Install one UL Listed EOL device (Hochiki P/N 0400-01000, 22 kΩ) each between the NO and C terminals of the AC failure output and battery failure output of the External Power Supply (see item 3 in the figure above)
4. Observe the FLM-325-214 programming rules (see item 4 in the figure above):
Input A - AC failure N/C
Input B - Battery failure, N/C
5. Enable the External Power Supply:
By keypad, use shortcut 6-6-2-4 for PROGRAMMING -TIMERS AND SYSTEM- SYSTEM- EXTERNAL POWER (see *Shortcuts*, page 91 and/or *Menu Structure*, page 92)
By browser, select the local panel settings on the Site Data screen

5 Monitoring, Operating, and Programming



Caution!

The panel controller can be operated only by trained personnel.

Message displays on the panel controller must be processed only by trained personnel.

The system walk test and detector configuration must be performed only by trained, authorized personnel.

When used in UL Listed installations, the control panel must conform to certain programming requirements. Refer to *UL 864 Standard-specific Requirements, page 43* on *UL 864 Standard-specific Requirements, page 43*.

5.1 Authority Level and PIN Codes

The panel offers different authority levels:

The front door key is required to enter the keypad for navigating menu functions and executing Level 1 (control) operations.

A Personal Identification Number (PIN) is needed for further operation. The PIN is a four-digit code. Valid digits are numbers from 0 to 9.

The default PIN codes for the different authority levels are listed in the following table.

	Access	Default PIN	Description
Level 1	Key (no PIN)	-	Basic operation level
Level 1RSD ¹	PIN	1111	Reset, silence
Level 2	PIN	2222	Maintenance level
Level 3	PIN	3333	Programming level
Web operator level	PIN	0000	Login from web browser (for viewing only)

¹ For special applications, PIN assignment for reset, silence, and drill is required (control)

Tab. 5.38: Overview of authority levels and default PINs



Caution!

To prevent unauthorized access to the panel and its various authority levels, please change the login credentials for the panel. Make a secure record of the new credentials.

The operations allowed for each authority level set by default can be changed by an authorized Level 3 user. For special applications, PIN assignment for reset, silence or drill operation (control) is optional.

In addition, you can access the FPA-1000 Web with the Web operator PIN.

Change these default codes to codes of your personal preference. Do not program PINs with common sequences such as 1111, 1234, or 2468 because they are easily violated. Do not share your PIN with another person.

At the panel, you need the front door key to access the Acknowledge [ACK] key. At a remote annunciator (FMR-1000-RA or FMR-1000-RCMD), the scrolling functions and the Acknowledge [ACK] key are accessible without restriction. On the FMR-1000-RCMD, the keys for reset, silence or drill can be enabled and disabled by the device key.

The operations assigned to the authority levels in default mode, and assignment that can be changed by programming are described in the following table.

Authority levels	Operations						
	reset, silence,drill	history	walk test	test	change date/time	bypass/unbypass	programming
Level 1	D ¹	D	P	P	D	P	-
Level 2	+	+/-	D	D	P	D	-
Level 3	+	+	+	+	+	+	+
P = Operation can be enabled or disabled in this authority level by programming							
D = Operation is enabled by default and can be disabled in this authority level							
- = Operation is not allowed in this authority level							
+ = Operation is always allowed in this authority level							
¹ PIN assignment is optional for reset/silence/drill (Level 1RSD)							

Tab. 5.39: Authority level and assigned operations (default and programmable)

To reprogram an authority level assignment:

- By keypad, use shortcut 6-5-1 for PROGRAMMING -USER ACCESS-USER PIN CODES (see *Shortcuts, page 91* and/or *Menu Structure, page 92*)
- By browser, change the appropriate PIN codes on the Site Data screen

5.2 Panel access

Any FPA-1000 panel can be used as a stand-alone fire panel. Multiple FPA-1000-V2 panels can be interconnected using Networking Cards installed in each panel to create a peer-to-peer networked system. Panels within the networked system can be programmed into a networked group. Within such a networked system, certain programmable device settings can be defined as:

Panel-wide parameters - only apply to the specific panel to which the device is connected (i.e., local zones 1-128).

Network-wide parameters - apply to all panels in the network system (i.e., Group zones 129-225 and Global zones 226-234). All monitoring activities will report on every panel and all operating and programming activities can be performed from any panel.



Notice!

In a networked system, some panel-wide remote programming options are not available when programming one networked panel from another networked panel. These options are only programmable on the panel being used for programming.

The FPA-1000 fire panels enable various approaches for monitoring, operating and programming. The status of a panel can be monitored through the panel’s keypad display, built-in status LEDs and piezo sounders.

- On-site at the front panel to program a stand-alone panel or all panels in peer-to-peer network, but not all parameters can be programmed
- On-site through a Web server using a laptop (connected to the panel with CAT5 cable)
- Remote through a Web page and an Ethernet connection

For on-site monitoring, operation and programming using the built in LCD keypad, see:

- *Keypads, page 80*
- *Keypad Operations, page 84*
- *System Normal Displays, page 86*

- *Off-normal Displays, page 88*
- *Menu Navigation and Structure, page 90*

For connections using a PC (connected to the FPA-1000 panel either locally or remotely), see *Browser Navigation and Structure, page 98*.

Controlling Remote Login

The panel provides a programming function to treat remote login three ways:

- Remote login with required confirmation at the panel for programming operations
- Remote login without confirmation at the panel (refer to UL 864 Standard-specific Requirements, FilterByAttributes Variables on FilterByAttributes Variables)
- Remote login disabled

Any remote connections through the dialer must first be confirmed at the panel.

Simultaneous Access

The system allows any number of users at a time for the viewing function and for controlling operations of the panel. For uploading or programming which requires the Level 3 PIN code, the simultaneous panel access is limited to one user at a time. The user at the control panel always has the highest priority.

Simultaneous Access shows the access priority and system response, if one user is operating the panel and a second user tries to access the panel.

First User	Second User	Access Priority and System Response
Local	Remote	Second (and any further) user is provided a message "Try again later". The local login cannot be terminated by a remote login.
Remote	Local	Local user can choose if he or she would like to terminate the first user or not. If the remote programming option is set to 1-CONFIRM AT PANEL, the system prompts for confirmation at panel side. Web access is granted as soon as the correct PIN is entered at the panel. If an invalid PIN is entered, an error message appears on the web page and the access is denied. Observe access level time-out! After 25 min without any action, Access Level 2 or 3 become invalid. In Level 3, the user is notified one minute before the session expires. In Level 2, the user is notified when trying to perform a Level 2 action the next time. Access Level 1 does not time out.
Remote	Remote	Second (and any further) user is provided a message Another request is in progress. Please try later. The first remote login cannot be terminated by the following remote login.

Table 5.40: Access Priority and System Response

After denial of access, a second user can view the current panel display.

5.3 Keypads

The Liquid-crystal Display (LCD) keypad is visible with the cabinet door closed. Tabs with different language versions are provided to change the text for the LEDs and keys.

The FMR-1000-RA LCD annunciator allows for remote viewing and monitoring, including the acknowledge function. Additionally, the FMR-1000-RCMD LCD annunciator features operation keys reset and silence.



Notice!

On networked systems, all panels on the network or all panels within a defined group can be programmed and operated from any panel within the group or network. All signals activated by a panel within a group or within a network will be reported on every panel within the group or network.

Display

The FPA-1000 panels use an 80-character (4 lines X 20 characters) wide-viewing-angle LCD display. The display includes a long-life LED backlight. If AC power is lost and the system is not in alarm, the LED backlight is turned off to conserve the batteries. There is a blue potentiometer (POT) located at the left along the bottom edge of the mainboard. To adjust the keypad display, turn this POT clockwise to lower display contrast or counter-clockwise to increase display contrast.

Keys

The keypad has 22 keys, including a 12-key alphanumeric pad similar to a telephone keypad with numbers 0 to 9, asterisk [*] and pound sign [#], Escape [ESC], enter [↵] and arrow keys (left, right, up, down). The alphanumeric keys are used to enter text information similar to the way telephone keys are used to process information over the telephone lines. Each key represents up to five letters, numerals or symbols.

In input character mode, use the key codes for the characters as follows:

Single press	First character on key
Double press	Second character on key
Triple press	Third character on key
4-times press	Fourth character on key 7 and 9, or number on other keys
5-times press	Number on key 7 and 9, or like single press on other keys

Exception for [0] key:

Single press on [0]	Toggles lower/upper case setting
Double or further press on [0]	Enters "0"

Special function in time mode:

Single press on [2]	Enters "a" for AM at 5th digit in time setting
Single press on [7]	Enters "p" for PM at 5th digit in time setting

Special function in phone number mode:

Key codes	0 to 9
Single press on [*]	Enters "," in phone numbers, causes a two-second delay in dialing

Single press on [#]	Enters “/” in phone numbers, causes a 125 ms delay in dialing
Special function in IP address mode:	
Key codes	0 to 9
Single press on [*]	Enters “.” in between byte fields
Special function in PIN check mode:	
Key codes	0 to 9, displays digits as “*”
Special function in Date/Time mode:	
Key codes	0 to 9; “/” and “:” are skipped automatically
Delete key [Λ]	Invalid.

After a pause (key not pressed) for 2 seconds, the cursor moves to the next position. The character at the actual position is overwritten.

Special functions for the arrow keys:

Up	Delete
Down	(reserved)
Left	Move input position to the left
Right	Move input position to the right

LED indicators

LCD display, 4 x 20 characters

Operation keys for drill, reset, silence and acknowledge







Alphanumeric keys

Arrow keys for left/right/up/down

Enter and Escape keys

LED Indicators

The front panel and remote LCD annunciators have LEDs following the global system status.

LED		System status
Fire  Red	On	Whenever the system registers a fire alarm and is not reset
	Off	If no alarm registered After resetting
Gas Alarm  Blue	On	When the system registers a gas alarm and is not reset
	Off	If no gas alarm registered After resetting
Power  Green	On	If AC power is applied to the panel
	Flashing	When AC power fails and the unit operates from battery power
	Off	When no power (AC or battery) is applied
Supervisory  Yellow	On	When the system registers a supervisory condition
	Off	When no supervisory condition is registered
Silenced  Yellow	On	When an alarm or trouble condition is silenced manually by the user If the system auto-silence timer expires
	Off	When no condition is silenced When a silenced condition is corrected
Trouble  Yellow	On	When the panel is initializing When the panel registers a trouble condition from a point, or the panel When inputs or outputs or other elements are bypassed
	Flashing	When the panel is not operating When walk test is in progress
	Off	When no trouble condition exists When the panel is resetting
		LED flash rate is 1 Hz (0.5 s on, 0.5 s off).

Tab. 5.41: LED indication

All LEDs on the panel keypad and on remote LCD/LED annunciators light steadily during the lamp test operation.

On the remote LED annunciators, the LEDs indicate the status of software zones individually.

Piezo Sounder

Every keypad or annunciator has a piezo sounder that provides audible indication of the system status. For piezo modes, see the following table.

Piezo Operation	System Status
Silent	The panel is in a normal state (no alarm, supervisory or trouble condition) The panel was silenced or acknowledged after an off-normal condition
Continuous beep	The panel is in fire alarm condition
Periodic beep (0.5 s on every 2 s)	The panel is in gas alarm condition
Periodic beep (0.5 s on every 4 s)	The panel is in supervisory condition
Periodic beep (0.5 s on every 10 s)	The panel is in trouble condition Indicates automatic logout within 1 minute if logged in at Level 1, 2 or 3
Short beep	With every key press
Triple beep	With invalid entries

Tab. 5.42: Piezo operation

5.4

Keypad Operations

View Status

With no alarms or troubles in the system, the display message is SYSTEM NORMAL along with the current date and time.

During initialization by start-up or re-configuration, the screen indicates SYSTEM INITIALYZING.

Upon reset, the panel shows the SYSTEM RESETTING screen until the system returns to the normal supervising condition.

If PAS or Pre-signal is turned on, the screen indicates SYSTEM NORMAL DAY.

Any off-normal conditions are shown in groups classified as fire alarm, gas alarm, supervisory and trouble.

Use the arrow keys to view events or conditions in the same group. Up [↑] and down [↓] keys move the user to the previous or next event. The left and right keys switch to other groups.

Acknowledge

During an alarm, pressing the Acknowledge [ACK] key turns off the piezo that is sounding on a keypad or annunciator. All the ongoing events or conditions are marked as Acknowledged. The 24-hour trouble reminder timer starts. For that, any trouble event not cleared within 24 hours is sent again and the piezo sounder begins to beep again.

If a fire input point configured as PAS Enabled (with global PAS enabled) is activated, pressing the Acknowledge [ACK] key within 15 seconds after a PAS activation starts the investigation timer. This allows the user to investigate the fire alarm or take other appropriate actions until the timer expires.

An acknowledgement operation can also be initiated by the activation of an input point configured as an acknowledge type.

To run a lamp test, press and hold the Acknowledge [ACK] key for at least 3 seconds. All LEDs on the keypad are turned on and the keypad's LCD display is filled with black boxes. When the [ACK] key is released, the keypad displays the software revision number, the panel ID, and the panel's IP address for 3 seconds. Then the LEDs and display return to normal working mode.

Silence

When the silence operation is initiated, the following actions occur:

- The silenced LED turns on. The panel goes into a silenced status.
- The piezo sounders on all keypads and annunciators turn off.
- All outputs configured as **Silenceable** are silenced.
- NACs play the silenced pulse for the programmed pattern, or they fully de-energize, as defined by the global option **Silence Config**. Strobes continue flashing.
- All the ongoing events are marked as **Acknowledged** when the [SILENCE] key is pressed.
- Silence operations are logged into the history.
- If programmed, the panel transmits a silence report to the central station.
- The trouble reminder timer starts.

The silence operation can initiate by activation of an input point that is configured as a silence type (see *Events*, page 29). The silence operation does not reset the alarm status and does not return the activated input to normal service. Any new alarm reactivates any silenced outputs. If the root cause for activating the sounders is not corrected within 24 hours, the sounders can reactivate.

To program silencing for individual outputs:

- By keypad, use shortcut 6-1-1 or 2-2-2 for PROGRAMMING -SLCS-SLC 1 or SLC 2-EDIT A DEVICE-SILENCEABLE (see *Shortcuts*, page 91 and/or *Menu Structure*, page 92)
- By browser, check or uncheck the Silenceable box for the specific circuit on either the Mainboard or Option Bus screen

Waterflow Silenceable

The panel provides a global option to control silencing of the panel when a waterflow-type alarm activates. If the Waterflow Silenceable option is activated, the silencing operation on the panel is allowed, regardless if there is any waterflow alarm. Otherwise, the silence operation is not performed. Respectively, any silencing operations including the use of the silence key and automatic silencing are ignored.

Automatic Silencing

The panel provides an automatic silencing feature as an optional configuration. The user can program an automatic silence time within the range from 5 to 60 minutes. If automatic silence is enabled, the first alarm in the system starts the automatic silence timer. When a time-out occurs, a silencing operation is executed. If a second alarm occurs within the automatic silence time, the auto-silence timer does not restart. After automatic silencing, any new alarm cancels the silence operation and starts the auto-silence timer again. Auto-silence is suppressed if the panel is programmed as Waterflow Not Silenceable and there is at least one waterflow alarm.

Alarm/Trouble Reminder

If any events are not cleared within 24 hours after the [SILENCE] or [ACK] key was pressed, the panel re-sounds the piezo sounder and events are transmitted to the central station again.

Reset

When a reset operation is initiated, the following actions occur:

- The piezo sounder and activated or silenced outputs turn off.
- All alarm, supervisory, and troubles caused by activation of SLC points are cleared. Then the panel tries to reset all points that are in off-normal status. Not all system trouble conditions are affected by a reset operation.
- The global resetting zone is activated for 5 seconds. This way users are able to assign some auxiliary outputs to indicate that the system is being reset and is not in normal operation condition.

- Auxiliary power AUX/RST is turned off for 5 seconds.
- Any input points remaining off-normal are indicated again after reset.
- Reset operations are logged into the history.
- If programmed, the panel transmits a reset report to the central station.

The Reset operation can also initiate by activation of an input point configured as a reset type.

Drill

To activate the drill operation, the [DRILL] key must be pressed twice to prevent accidental activation. Press the key once the system prompts for confirmation. Pressing the [DRILL] key again turns on all unbypassed NACs and drillable relay outputs.

Upon drill operation, the following actions occur:

- All unbypassed NACs turn on.
- At the beginning of a drill operation, a Drill Start Report is logged into the history and, if programmed, transmitted to the central station.
- Each NAC plays the pattern programmed for it.

Drill operation stops if the reset key is pressed, or is automatically cancelled if the operation was started for a programmed time. When the drill operation stops, the following actions occur:

- All activated NACs turn off.
- A Drill Stop Report is logged into the history and, if programmed, transmitted to the central station.
- A system reset is automatically performed by stopping the drill so that the panel and all field devices restore to their normal operation.

The Drill operation can also initiate by activation of an input point configured as a drill type.

After a user presses the drill key, the panel requests confirmation or, if necessary, entry of the PIN code.

5.5 System Normal Displays

With initialization of the system, the display shows:

Bosch Fire Systems FPA-1000 System Initializing [MM/DD/YY hh:mm]	
---	--

As soon as the configuration is loaded or reloaded, the system asks for date and time.

When no alarms or troubles exist in the system, the Power LED lights steadily, and no other LEDs are lit. The display shows:

Banner Line 1 Banner Line 2 SYSTEM NORMAL [MM/DD/YY hh:mm]	
---	--

If the panel is in Day Mode, the display shows:

Banner Line 1 Banner Line 2 SYSTEM NORMAL DAY [MM/DD/YY hh:mm]	
---	--

The user can program the banner lines. To program the banner lines while on-site:

- By keypad, use shortcut 6-6-2-9 for PROGRAMMING -TIMERS AND SYSTEM-SYSTEM-Banner LABEL (see *Shortcuts, page 91* and *Menu Structure, page 92*)
- By browser, change the Banner lines text on the Site Data screen

The bottom line in the display indicates the current date and time in the format MM/DD/YY and hh:mma (a = am or p = pm).

If the system is programmed to require a PIN, the screen shows Please Enter PIN:.

The control panel performs the following functions at regular intervals when the system operates normally:

- Polls all circuit devices and the four Notification Appliance Circuits (NACs), checking for valid replies, alarms, troubles, and so on
- Checks for power supply troubles and batteries
- Scans the keypad for system reset or Enter commands
- Performs automatic tests on detectors
- Tests the system memory

Display Placeholders

For placeholders used for normal, off-normal and menu display, see the following table.

D	Appears in the right upper corner if the system is in Day Mode
pp	Panel number
c or l	Circuit number
aaa	Address
s	Subaddress
MM/DD/YY	Month, day, year
hh:mma	Hour, minute, am or pm
yyy	Number of the event in the list
xxx	Total number of events in the list
[Device Type]	Any text shown in brackets = relevant system information; for example Device Type or Point Type
<i>Label</i>	Any label text shown in Italics can be programmed by the user

Tab. 5.43: Display placeholders

The displayed point types are listed in Display Placeholders. For further information of point types, see the following table.

FPA-1000 Point Type	Point Type Display
Fire Automatic	DETECTOR
Fire Alarm Manual	PULLSTAT
Waterflow	WATERFLOW
Waterflow with Delay	WATERFLOW
Gas Alarm	GAS ALARM
Supervisory	SUPERVSR
Generic	GENERIC

FPA-1000 Point Type	Point Type Display
Trouble	TROUBLE
AC Failure	AC FAULT
Battery Failure	BATT FAULT
Reset	RESET
Silence	SILENCE
Drill	DRILL
Acknowledge	ACK
General Fire Alarm	FIRE ALARM GENERAL

Tab. 5.44: Point type display

The abbreviations used in display texts are listed in *Abbreviations on the Control Panel Display*, page 114.

5.6 Off-normal Displays

If any off-normal condition exists, the panel shows the first highest-priority condition. Conditions are classified in groups that include fire alarm, gas alarm, supervisory and trouble. For each group, the number of off-normal conditions is shown. The panel stores up to 255 events for each group at a time. Any restored event is deleted from the list. If more than 255 events exist, the newest events are discarded. Left and right keys are used to switch between fire alarm, gas alarm, supervisory and trouble messages. The scroll down key is used to view individual messages. The [ESC] key returns the user to the upper level.

Fire Alarm Screen

Fire Alarms: Press v To View Press </> To View Troubles/Gas Alarms	10
---	----

The example above shows ten fire alarm messages. Press [Λ] or [v] to view individual alarm screens.

FIRE ALM [pp - l - aaa.s] [MMDDYY hh:mmayyy/xxx] [Device Type] <i>Point Label</i>	
--	--

PAS Acknowledge Screen

Fire Alarms: Press v To View To Investigate ACK Within 15 Seconds	1
--	---

The time is counted down until time-out. Without acknowledging, the system switches back to the general Fire Alarm screen. If [ACK] is pressed within the acknowledge time, the system shows the PAS Reset screen.

PAS Reset Screen

Fire Alarms: Press v To View Investigating RESET Within 180 Seconds	1
--	---

The example shows a programmed PAS investigation time of 180 seconds (= default). The time is counted down until time-out. Without reset, the system switches back to the general Fire Alarm screen. If [RESET] is pressed within delay time, the system shows the PAS Reset screen. If the point is not in alarm, it will then go to normal screen. If the point is still in alarm, it will display investigating again.

Gas Alarm Screen

Gas Alarms: Press v To View Press </> To View Fire Alarms/Supervsr	3
---	---

The example above shows three gas alarm messages. Press [Λ] or [v] to view individual gas alarm screens.

GAS ALM [pp - l - aaa.s] [MM/DD/YY hh:mmayyy/xxx] [Device Type] <i>Point Label</i>	
---	--

Supervisory Screen

Supervisories: Press v To View Press </> To View Gas Alarms/Troubles	5
---	---

The example above shows five supervisory messages. Press [Λ] or [v] to view individual supervisory screens.

SUPERVSR [pp - l - aaa.s] [MM/DD/YY hh:mmayyy/xxx] [Device Type] <i>Point Label</i>	
--	--

Trouble Screen

Troubles: Press v To View Press </> To View Supervsr/Fire Alarms	100
---	-----

The example above shows 100 trouble messages. Press [Λ] or [v] to view individual trouble screens.

TROUBLE [pp - l - aaa.s] [MM/DD/YY hh:mmayyy/xxx] [Device Type] [Trouble Type] Point Label	
---	--

When the walk test starts, the screen shows:

TROUBLE [pp - l - aaa.s] [MM/DD/YY hh:mmayyy/xxx] [User Level] Walk Test [Inputs to test]	100
--	-----

[Inputs to test] = selected range of operation

When walk test ends, the screen shows:

TRB RST [pp - l - aaa.s] [MM/DD/YY hh:mmayyy/xxx] [User Level] Walk Test [Inputs to test]	100
--	-----

If the walk test is stopped by a reset input point on the SLC, this device type is shown instead of the user level.

History Screen for Controls

Viewing controls, the screen shows:

hCONTROL [pp - l - aaa.s] [MM/DD/YY hh:mmayyy/xxx] [Device Type] [Control Cat.] Point Label	100
--	-----

[Control Cat.] = Control Category: Reset, Silence or Drill, Generic, Unverified
Generic controls, unverified activation event from input points programmed as Alarm Verification type and communicator test (either automatically by the panel or manually by the user) are listed in Controls category.

Screen for Remote Programming Dialer Trouble

TROUBLE [pp - l - aaa.s] [MM/DD/YY hh:mmayyy/xxx] Dialer Answering #####	100
---	-----

The bottom line shows the phone number if no longer than 20 digits, or number signs if longer than 20 digits, or “Unknown” if no caller ID is detected.

5.7 Menu Navigation and Structure

As soon as a user presses a valid key and starts an operation, a user timer starts and the panel monitors for further key press activities. If no key is pressed within 25 minutes, the panel automatically returns to the normal state (see *System Normal Displays, page 86*) or off-normal state (see *Off-normal Displays, page 88*).

When the Enter key [↵] is pressed, the main menu appears and the user can press any shortcut key (see) to perform the operations available, if allowed. If the selected operation requires access to a higher authority level, the user is asked to enter the PIN.

The [ESC] key returns to upper level from the menu. As soon as the initial screen (normal or off-normal state) appears, the screen prompts the user for the PIN again if it is needed for the selected operation.

When logged in at Level 3, an automatic logout is indicated one minute in advance. Pressing the Enter key [↵] terminates the automatic logout.

Any operation (except viewing and acknowledge) from local or remote access is logged with the access address (for example the IP address of the PC).

Some operations are logged into the history and, if programmed, reported to central stations. If an invalid PIN is entered, an error beep sounds and the operation is denied.

Every menu has its description, which can be abbreviated, on the first line of display. The submenus, options, or actions under this menu are listed on the second to the fourth line, each item on one line. If there are more than three items, items other than 1 to 3 can be viewed with the [v] key. Every [v] key press switches the screen to next three items, and so on. The [λ] key can be used to view the previous items with every key press to the previous three items.

Every item starts with a number, which represents the corresponding shortcut number key to select the item (refer to *Shortcuts, page 91* below). The shortcut key is also valid even when the item is not currently displayed.

If there are more than nine items under a menu, the items are organized as two pages. The [9] key is used to switch in between pages.

The [λ] key is not valid on the first three items, the [v] key is not valid on the last three items. For configuration items, the currently selected choice is indicated with an equal sign (=) while others have a space between the shortcut number and the description.

On a menu with on/off actions, for example output testing menus, the panel indicates the last action performed using an equal sign (=) instead of an arrow (->).

Shortcuts

Shortcuts can reduce repetition and provide speedy instructions for operating and programming the control panel.

The first level in the system is the main menu including six menu items. For example, HISTORY is menu item 1, PROGRAMMING is menu item 6. Therefore, the first number in the shortcut is "1" for HISTORY and "6" for PROGRAMMING.

The second level options are listed in the Level 2 column in the following Menu Structure tables. For example, there are three options for menu item HISTORY and nine options for menu item PROGRAMMING.

The second number in the shortcut enters the Level 2 option and allows access to Level 3. For example, use shortcut 6-9 for the Auto Learn option in the PROGRAMMING menu. Level 3 provides the third set of options that branch from Level 2 (refer to the Level 3 column in the following Menu Structure tables. The third number in the shortcut represents the option chosen in Level 3. For example, use shortcut 6-9-2 for the Auto Learn option for the SLC 1. The shortcut is simply a list of the keys you press to get to the required level option. A shortcut key is valid even when the item is not currently displayed. After you enter the shortcut, follow the procedure that appears on the screen of the specific function you are operating or programming.

Throughout this chapter, the text that indicates shortcut keys appear as follows:

6-PROGRAMMING, 9-AUTO LEARN, 2-SLC-1

5.7.1 Menu Structure

Level 1 (Main Menu)	Level 2	Level 3	Level 4
1-HISTORY	1-VIEW HISTORY	1-ALL 2-FIRE ALARMS 3-GAS ALARMS 4-SUPERVISORIES 5-TROUBLES 6-CONTROLS 7-COMM RETRIES	
	2-PRINT HISTORY	1-ALL 2-FIRE ALARMS 3-GAS ALARMS 4-SUPERVISORIES 5-TROUBLES 6-CONTROLS 7-COMM RETRIES	
	3-WALK TEST LOG		
	4-PRT WALK TEST LOG		
2-WALK TEST	1-INPUTS TO TEST (single panel - no network)	1-PANEL WIDE 2-SLC 1 3-SLC 2 4-SELECT ZONES	
	1-INPUTS TO TEST (network enabled)	1-NETWORK WIDE 2-SELECT PANEL 3-SELECT ZONES	
	2-AUDIBLE	1-SILENT 2-SHORT ACTIVATION 3-LONG ACTIVATION	
	3-START WALK TEST		
	4-PRT WALK TEST LOG		
Depending on whether or not a network is enabled, either the single panel or network 1-INPUTS TO TEST screen will be displayed.			

Level 1 (Main Menu)	Level 2	Level 3	Level 4
3-TEST MENU	1-COMM TEST	1-PRIMARY/LINE 1 2-PRIMARY/LINE 2 3-SECONDARY/LINE 1 4-SECONDARY/LINE 2 5-PRIMARY IP 6-SECONDARY IP 7-CITY TIE 1 8-CITY TIE 2	
	2-SLCS	1-SLC 1 DIAGNOSTICS 2-SLC 2 DIAGNOSTICS 3-PRINT SLC 1 DIAG 4-PRINT SLC 2 DIAG	
	3-POWER AND BATT	1-VOLTAGE LEVELS 2-TEST BATTERY/NACS	
	4-OUTPUTS	1-MB/OB RELAYS	1-MB RELAY 1 2-MB RELAY 2 3-MB RELAY 3 4-RELAY MODULE 1@9 5-RELAY MODULE 2@10
		2-MB/OB NACS	1-MB NAC 1 2-MB NAC 2 3-REMOTE NAC 1@11 4-REMOTE NAC 2@12 5-REMOTE NAC 3@13 6-REMOTE NAC 4@14
		3-SLC 1 RELAYS	
		4-SLC 1 LEDS/RLEDS	
		5- SLC 1 NACS	
		6- SLC 2 RELAYS	
		7- SLC 2 LEDS/RLEDS	
		8- SLC 2 NACS	
	5-LAMP TEST		
	6-VIEW OPTION BUS		
	7-VIEW SYSTEM INFO	1-SYSTEM REVISIONS 2-NETWORK INFO 3-MODULE REVISIONS 4-PANEL ID	
8-Reserved for future use			
4-CHANGE DATE/TIME			

Level 1 (Main Menu)	Level 2	Level 3	Level 4
5-BYPASS/UNBYPASS	1-GLOBAL	1-ALL INPUT POINTS 2-ALL OUTPUTS 3-ALL SLCS 4-ALL ZONES 5-UNBYPASS ALL	
	2-SLCS	1-SLC 1	1-THE WHOLE SLC 2-ALL INPUT POINTS 3-SELECT ADDRESS
		2-SLC 2	1-THE WHOLE SLC 2-ALL INPUT POINTS 3-SELECT ADDRESS
	3-ZONES	1-BYPASS ZONES	1-BYPASS 2-UNBYPASS
	4-MB/OB OUTPUTS	1-RELAYS	1-MB RELAY 1 2-MB RELAY 2 3-MB RELAY 3 4-RELAY MODULE 1@9 5-RELAY MODULE 2@10
		2-NACS	1-MAINBOARD NAC 1 2-MAINBOARD NAC 2 3-REMOTE NAC 1@11 4-REMOTE NAC 2@12 5-REMOTE NAC 3@13 6-REMOTE NAC 4@14
		3-CITY TIES	1-CITY TIE 1 2-CITY TIE 2
	5-DAY MODE	1-NO DELAY 2-PAS 3-PRE-SIGNAL	
	6-LIST OF BYPASSED	1-BYPASSED ZONES 2-BYPASSED I/O	

Level 1 (Main Menu)	Level 2	Level 3	Level 4
6-PROGRAMMING	1-SLC DEVICES	1-SLC 1	1-ADD A DEVICE 2-EDIT A DEVICE 3-DELETE DEVICES 4-COPY DEVICES 5-SLC WIRING 6-SLC LABEL 7-RECONFIG A DEVICE
		2-SLC 2	1 to 7 same as 1-SLC 1 8-INSTALLED
	2-OUTPUTS/OPTION BUS	1-RELAYS/OUTPUTS	1-MAINBOARD RELAYS 2-REMOTE MODULE 1@9 3-REMOTE MODULE 2@10
		2-NACS	1-MAINBOARD NACS 2-RNAC MODULE 1@11 3-RNAC MODULE 2@12 4-RNAC MODULE 3@13 5-RNAC MODULE 4@14
		3-SILINCE CONFIG	1-AUDIBLE ONLY 2-AUDIBLE/VISIBLE
		4-ZONE LED RANGE	1-ZONES 1-128 2-ZONES 129-255
		5-CITY TIES	1-CITY TIE 1 2-CITY TIE 2 3-BOARD INSTALLED 4-EVENT RANGE
	3-ZONES/FLOORS	1-DUAL ZONES	1-PAIRS 1-3 2-PAIRS 4-6 3-PAIRS 7-9 4-PAIRS 10-12 5-PAIRS 13-15 6-PAIRS 16-18
		2-SW OR GLOBAL ZONES	SELECT ZONE: ??
		3-FLOORS	SELECT FLOOR: ??
	4-DATE/TIME	1-TIME FORMAT	1-12 HOURS 2-24 HOURS
		2-DAY SENSITIITIES	1-DAY SENSI ENABLE 2-DAY SENSI START 3-DAY SENSI END
		3=-DAYLIGHT SAVINGS	1-ENABLE/DISABLE 2-START 3-END

Level 1 (Main Menu)	Level 2	Level 3	Level 4
6-PROGRAMMING	5-USER ACCESS	1-USER PIN CODES	1-PIN FOR CONTROL 2-LEVEL 2 PIN CODE 3-LEVEL 3 PIN CODE 4-WEB OPERATOR PIN
		2-OPERATIONS/LEVEL	1-CONTROLS 2-VIEW/PRT HISTORY 3-WALK TEST 4-TEST MENU 5-CHANGE DATE/TIME 6-BYPASS/UNBYPASS
		3-REMOTE PROG	1-CONFIRM AT PANEL 2-ENABLE 3-DISABLE
		4-SILENCE ENABLE	1-ENABLE 2-DISABLE
		5-DRILL ENABLE	1-ENABLE 2-DISABLE
	6-TIMERS AND SYSTEM	1-TIMERS	1-AC FAIL DELAY 2-AUTO SILENCE 3-WATERFLOW DELAY 4-VERIFICATION 5-SILENCE INHIBIT 6-INVESTIGATION 7-SANDWICH DELAY 8-DUAL-ZONE 1ST ALM 9-SEQUENTIAL RESET
		2-SYSTEM	1-WATERFLOW SILENCE 2-AUTO SILENCE 3-SUPERVSR LATCH 4-EXTERNAL POWER 5-PANEL IP AND ID 6-PRINTER 7-PANEL LANGUAGE 8-UNIT FORMAT 9-BANNER LABEL
		3-ERASE HISTORY	
		4-ADVANCED FEATURES	1-AUX POWER RESET 2-D-ZONE 1st ALARM 3-SANDWICH ALARM 4-EVENT PRINTING 5-GLOBAL DELAY MODE

Level 1 (Main Menu)	Level 2	Level 3	Level 4
6-PROGRAMMING	7-DACT	1-PRIMARY ACCOUNT	1-ACCOUNT NUMBER 2-REPORTING FORMAT 3-REPORTING PATH 4-PHONE NUMBER 5-IP REPORTING 6-AUTO TEST TIME 7-AUTO TEST FREQ 8-MAXIMUM ATTEMPTS
		2-SECONDARY ACCOUNT	Same as PRIMARY ACC.
		3-REPORT STEERING	1-ALARMS 2-SUPERVISORIES 3-ALARM RESTORALS 4-SUPERVISORY RST 5-TROUBLE/RESTORE 6-TESTINGS 7-SILENCE 8-RESET 9-DRILL
		4-REDIAL INTERVAL	
		5-DIALING TYPE	1-TONE DIALING 2-PULSE DIALING
		6-LINE ENABLE	1-LINE 1 ENABLE 2-LINE 2 ENABLE
		7-LINE 1 RING COUNT	
		8-REPORT RANGE	1-PANEL WIDE 2-Reserved 3-NETWORK WIDE
		9-Reserved	
	8-NETWORKING	1-NETWORK CARD	1-INSTALLED 2-PORT SUPERVISION
		2-NETWORK WIRING	1-CLASS A 2-CLASS B
		3-PANEL MANAGEMENT	1-ADD A PANEL 2-EDIT A PANEL 3-DELETE A PANEL
	9-AUTO LEARN	1-ALL 2-SLC 1 3-SLC 2 4-ALL SLCS 5-UPDATE OPTION BUS 6-ALL DIFFERENCES 7-RETURN TO DEFAULT	

Level 1 (Main Menu)	Level 2	Level 3	Level 4
7-RESET LEVEL 3 PIN	1-GET BUILDING CODE 2-ENTER BUILDING CODE		
Level 1 (Main Menu)	Level 2	Level 3	Level 4
This menu will display only if NETWORK CARD INSTALLED (6-8-1-1) is selected.			
8-REMOTEPGRAM	1-SELECT PANEL 2-PANEL ID		

In order to reset the level 3 PIN, You must obtain a Building Code and submit that code to the panel’s service center. After the code has been submitted to the service center, you have 24 hours in which to enter the code (7-2 for RESET LEVEL 3 PIN-ENTER BUILDING CODE) and change the PIN.

To get the building code:

- By keypad, use shortcut 7-1 for RESET LEVEL PIN 3 -GET BUILDING CODE
- By browser, click on under PIN Codes Level 3 (programming) on the Site Data screen

5.8 Browser Navigation and Structure

The FPA-1000 hosts a set of web pages for conveniently operating and programming the system. The off-line version of the web pages (available in the software downloads for the FPA-1000 panel on the Bosch web site [www.boschsecurity.com]) allows off-line processing of configuration and settings and uploading of the new configuration file through an Ethernet link or a local personal computer connection.

Browser-based operating and programming allows:

- Downloading of the entire program, history file, walk test data, current status, system voltages, time and dater
- Uploading of the entire program

After successfully downloading a program or executing any programming in the system configuration, perform the following steps:

- Check all programmed data on a printout or manually view programmed entries and compare them to intended program data
- Test all affected panel operations and immediately correct any problems found

5.8.1 Off-site and on-site access

For proper operation:

The FPA-1000 panel and the user’s computer must be connected to one IP network

The IP address at the FPA-1000 must be set to a valid value which is visible from the user’s computer. To specify the IP address by keypad, use shortcut 6-6-2-5 for PROGRAMMING - TIMERS AND SYSTEM-SYSTEM- PANEL IP AND ID (see *Shortcuts, page 91* and *Menu Structure, page 92*)

To obtain a valid IP address, contact your system or network administrator.

**Notice!**

Using the FPA-1000 in a LAN, corporate network or VPN

If the user's computer and the FPA-1000 are connected to one LAN, corporate network or VPN, the FPA-1000 must have a static assigned IP address because the FPA-1000 functions as a server. The client, which is the user's computer, must reference the IP address to contact the server. For operation in a corporate network, ask your system administrator to assign a static IP address.

Off-line (network) connection

First start the web browser on your computer. This can be Firefox or Internet Explorer.

The operation of the FPA-1000 web pages is based on JavaScript and cookies. Check that your computer will accept cookies from sites and that JavaScript is enabled. If necessary, indicate the site as a trusted site.

Enter the FPA-1000 IP address in the address line of the internet browser window. When asked for authentication, enter the user name and PIN for web operator access (see *Authority Level and PIN Codes*, page 78).

After successful authentication, the FPA-1000 web pages start page which you can see in the browser window. However, at this point, you only have viewing access rights. To obtain further access to the system, switch to a higher access level, such as:

- Level 2 - controlling outputs for testing and performing walk tests
- Level 3 - changing the panel program in the programming section

Level 3 is exclusive. Only one user can be in Level 3 at a time. When a second user tries to switch to Level 3 access from a web page, the user receives a message "A level 3 user is already logged in" and the user remains at the current level.

Only a user at the local FPA-1000 keypad has higher access status. The user at the keypad can overrule a user who is in Level 3 from a web page by logging in. When the local user logs in at the FPA-1000 and requests Level 3 access, the Level 3 access of the user on the web page becomes invalid and the next time this user tries to perform a Level 3 or Level 2 action, this user is notified.

On-site (local) connection

To establish an on-site (direct) connection from the FPA-1000 panel to the user's computer, the two devices must be connected using a crossover or straight Ethernet cable (CAT 5) with RJ45 connectors. The FPA-1000 panel supports "auto crossover detection."

Once the user's computer is physically connected to the FPA-1000:

- Open Network Connections from the Start Menu on your computer and choose to create a new connection
- Open the LAN connection or Local Area Connection (name depends on your computer) that is assigned to your Ethernet adapter and choose Status from the context menu
- Select (or if necessary install) Internet Protocol TCP/IP (where to find this depends on your computer)
- When Internet Protocol TCP/IP in the list of your network adaptor's properties, select this protocol from the list and click Properties and enter the valid IP address you have obtained from your system or network administrator

5.8.2**Working with web pages**

Enter the FPA-1000 IP address in the address line of the web browser window. When you press Enter, you are asked to provide authentication. Enter the User name and PIN for Web operator access (see *Authority Level and PIN Codes*, page 78).

After authentication, the FPA-1000 web pages Start page is displayed and is visible in the browser window on the user's computer. However, at this point, you only have viewing access rights (Level 1). To obtain further access to the system, you must switch to higher access levels, such as:

- Level 2 for controlling outputs for testing and performing walk tests
- Level 3 for changing the panel program in the programming section

Level 3 is inclusive. Only one user can be in Level 3 at a time. When there is a user at Level 3 and a second user on the web pages tries to switch to Level 3, the second user remains at the current level and receives a notice "A level 3 user is already logged in."

Only a user who is at the FPA-1000 keypad has a higher access status. That user can overrule a user who is at Level 3 remotely. When the second user logs in at the keypad, the first user's Level 3 access becomes invalid and receives notification when trying to perform a Level 3 or Level 2 action (such as, saving data to the FPA-1000).

To switch from one access level to another while on the FPA-1000 web pages, press the login button at the top of the left-hand column of the browser Start page. You can switch from web Operator Level or Level 1 to a higher level (Level 2 or Level 3) by entering the appropriate PIN number for the desired access level into the dialogue which appears after pressing the Login button.

From Level 2 or Level 3 you can switch to Level 1 without having to re-enter your PIN. In order to switch from Level 2 to Level 3, you need to go to Level 1 first. Then press Logout and the Login and enter the Level 3 PIN.

After 25 minutes without any action, Access Level 2 or 3 become invalid. In Level 3, the user is notified one minute before the session expires. In Level 2, the user is notified the next time the user tries to perform a Level 2 action. Level 1 does not time out.

Making program changes effective on the FPA-1000

Changes to the FPA-1000 programming can be made in Access Level 3 only. In lower access levels the FPA-1000 web pages does not accept the Save to panel action.

In order to make changes effective for the FPA-1000 operation, press the Implement configuration button or directly leave Access Level 3. When leaving Level 3, you are prompted to select if the recent changes made already saved to the FPA-1000 should become effective or if they should be discarded. This is the last chance for the user to keep the currently effective configuration before the recent changes become effective. When you press the Implement configuration button or confirms the recent changes when leaving Level 3, the FPA-1000 resets and initializes the new configuration.

System progress and status information are listed on the white sections of the browser window.

5.9 Overview of the web user Interface

The web user interface allows for convenient processing of the tasks listed in the following table. The system prompts for authorization if needed for a requested operation.

Page	Options
Start Page	Upload and download panel configuration, compare configuration files, download history and walk test history, display current panel time, synchronize panel with selected time zone, enter online configuration
Programming	

Page	Options
Site Data	Set up banner label and IP and ID, assign local panel settings, change PIN codes and assign operations to authority levels, schedule daylight savings time and detector day sensitivity time, set other timers, select language, select time format, select units for panel menu, select latching and silence and drill function settings, assign printer address and select printing options
SLC 1	Set up configuration data for SLC 1
SLC 2	Set up configuration data for SLC 2
Mainboard	Configure mainboard outputs (relays, NACs and City Tie)
Option Bus	Configure Option Bus devices (LED and LCD annunciators, LCD keypads, output modules, and Remote Notification Appliance Circuit [RNAC] power supplies)
Reporting	Configure primary and secondary account, specify PSTN and IP settings including IP encryption, and define report steering
Zones/Floors	Configure global and group and local zones, configure dual zones, configure floors for sandwich alarm
Networking	Indicate network card installation and port supervision, specify network-wide wiring topology (Class A or Class B), synchronize network-wide settings, list networked panels
Maintenance	
Control	Individually control all outputs - Mainboard (relays, NACs , and City Tie),Option Bus (LED annunciator test), SLC 1 and SLC 2 (outputs)
Testing	System information - Walk test, SLC 1 and SLC 2 test, Software Update, and Communicator test
Monitoring	
View Status	Show current panel status listing - fire and gas and supervisory alarms and troubles Allow for drill, reset, silence, and acknowledge
History	Show history and walk test history with downloading option
Utilities	
Help	Offers the complete Online Help content, one tab for each page

Default settings

For a summary of default settings, see *Default Programming, page 116*.

Authorization PIN codes

The user is asked to enter a PIN code if one is needed for the requested operation on the web page. Without valid authorization, the operation cannot be performed. In the top left corner of each we page, the actual authority level appears. The window status shows “Level ?” as long as no login has been performed. Click the login button to open the window for entering the appropriate PIN code.

Invalid entries

Whenever you enter an invalid value, the system provides information about the correct range. You cannot leave the input field without entering a correct value.

Label text

The user can set up labels for different applications (for example, to document the location of a device). Generally, the label text is limited to a maximum of 20 characters.

6 Diagnostics and Troubleshooting

6.1 Phone monitor troubleshooting

Comm Fail/DATA LOST

A common cause of this fault condition is failing to program Phone/IP Number 2 or Account Number 2. If report steering is directed to use Phone/IP 2 as Backup, reports made to an unprogrammed Phone/IP Number 2 or Account Number 2 warn the installer that Phone/IP Number 2 is not available.

Other communications problems that can cause this condition include events occurring faster than the dialer can send them which causes the 32 event buffer to overflow, or other problems contacting a receiver.

Check the dialing type, format selection, phone numbers, account codes, phone line condition and tone programming (if tone burst formats are used). For more information, see *Reporting Requirements*, page 40.

Some troubleshooting tips for phone monitor problems are listed below:

1. Use a voltmeter to measure the voltage present across each phone line (Tip to Ring) while the phone line is idle.
The voltage present during ringing for an incoming call can be more than 100 V AC. The standby telco battery voltage is typically in the range of 30 V DC to 50 V DC, but any voltage above 5 V DC is accepted by the control panel.
The polarity of the voltage does not matter.
2. Check for other devices that might use the phone line, such as fax machines, credit card verifiers or PBX systems.
If the devices cannot be removed, ensure that they are wired so that the control panel's line seizure relay disconnects them when necessary.
Measure the line voltage while these devices are in use. Ensure that it remains above 5 V.
3. Check for intermittent faults in the phone line.
Make a test call and confirm that the line is free of distortion and noise.
Temporarily exchange Lines 1 and 2 on the control panel and check if the problem indication moves to the control panel's other phone line channel. If so, the phone line is causing the problem rather than the line monitor.
4. Confirm that the fault message is LINE 1 Disconnect (or LINE 2 Disconnect) and not Pri Acct Comm Fail (or Sec Acct Comm Fail).
A Comm Fail can also occur if one of the phone lines has telco battery voltage, but does not complete a call. Make test calls to the receiver(s) on both phone lines, listening for the receiver ACK tone.
5. Ensure that two phone lines are available.
In accordance with NFPA requirements, the Auto-test report is sent on a different phone line each time it is sent. If only one phone line is connected to the control panel, a Comm Fail is generated on every other test call. See *Reporting Requirements*, page 40.

6.2 Diagnostics Data and System Information

Auto/Manual Test Report

Any user authorized to enter test menu (Level 2 by default) can initiate transmission of manual test reports to central station accounts. The Report Steering option allows for programming to which central station manual and auto test reports are sent. For a manual test report, the user selects either phone line or IP address to send the test report. The panel provides options for all possible combinations of phone lines and destinations and all IP paths to send the manual test report. Every communication failure is logged in the history.

Task	Web page
Individual operation Of Mainboard outputs	Maintenance - Control - Mainboard
Individual operation of Option Bus outputs	Maintenance - Control - Option Bus
Individual operation of circuit outputs	Maintenance - Control - SLC 1/SLC 2
General HW and SW information	Testing - System Information
Configure and perform walk test	Testing - Walk Test
Perform communicator test	Testing - Communicator Test
Read out dynamic data of circuit devices	Testing - SLC 1/SLC 2 Test
Upload of new panel software	Testing - Software Update
View current panel status	Monitoring - View Status
View/download history data	History - History Data
View/download walk test history	History - Walk Test History Data

Tab. 6.45: Off-site diagnostic via browser-based user interface

Task	Menu Shortcut
View history data	1-HISTORY, 1-VIEW HISTORY
Print history data	1-HISTORY, 2-PRINT HISTORY
Perform communicator test	3-TEST MENU, 1-COMM TEST
View/print SLC diagnostics	3-TEST MENU, 2-SLCS
View voltage level and perform battery load test	3-TEST MENU, 3-POWER AND BATT
Test relays, NACs and SLC outputs	3-TEST MENU, 4-OUTPUTS
Perform annunciator lamp test	3-TEST MENU, 5-LAMP TEST
View Option Bus devices	3-TEST MENU, 6-VIEW OPTION BUS
General HW and SW information	3-TEST MENU, 7-VIEW SYSTEM INFO
View network status	3-TEST MENU, 8-NETWORK STATUS

Tab. 6.46: On-site diagnostic at panel keypad

6.3 FPE-1000-SLC LED Operation

Two LED indicators on FPE-1000-SLC Plug-in Module give some simple diagnostic information and show that the module is communicating with the fire panel. The LED indicators can be seen only when the dead front door of the panel is removed.

LED	Description
Green	Bus Communication
Yellow	Failed Bus Communication (Loss Counter increase)

If a parity error occurs, or a checksum error occurs, or a time-out error occurs, the communication is tried again for three times consecutively. Every error increases the loss communication counter.

To reset the loss counter, open the browser or off-line tool and use SLC 1 Test or SLC 2 Test on the Testing screen.

6.4 Power and Battery Test

To see displays of voltage levels for AC, AUX power and battery, use the keypad shortcut 3-3-1 for TEST MENU-POWER AND BATT-VOLTAGE LEVELS.

To automatically perform battery tests, use the keypad shortcut 3-3-2 for TEST MENU-POWER AND BATT-TEST BATTERY/NACS. The system turns on NACs to measure battery voltage.

Depending on whether the test was successful or not, the message “Passed” or “Failed” appears on the screen.

7 Maintaining

7.1 Battery Maintenance

This product requires two 12 V batteries in series for a combined voltage of 24 V. Maximum capacity is 40 Ah. The enclosure can hold two 7 Ah or 18 Ah. Larger batteries (24 Ah or 38 Ah) must be in an additional battery box.

Perform a battery load test (see *Power and Battery Test, page 105*) at least twice per year. Replace batteries that fail the test. Battery voltage should be ≥ 26 V.

Recommended Battery Manufacturers	
POWER SONIC	PS-1270, PS-12170, PS-12180
YUASA	NP7-12, NPG18-12

7.2 Fuse Replacement

The fuse is located at the lower left of the mainboard (see the following figure). Replace with a 15 A blade type fuse only.

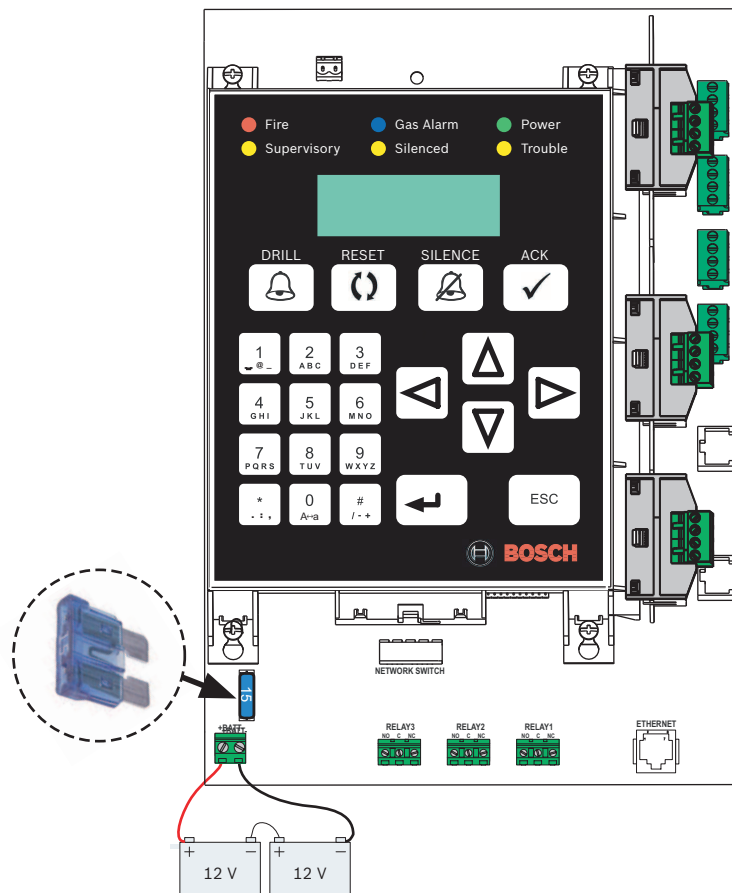

Figure 7.1: Fuse Replacement

7.3 Network Communication Reset

**Notice!**

This action is intended to be performed only by trained, authorized personnel when network communication has been disrupted or is not responding and needs to be reset.

Each network card has a small blue button on the top surface of the card. Press this button to reset the networking card.

7.4 System Reset

There is a small blue button to the right of the potentiometer along the bottom edge of the mainboard that acts as a system reset button. To momentarily remove power from the panel, press this button. When the button is released, the panel re-initializes. If the panel is part of a networked system, re-initializing the panel re-initializes the entire networked system.

8 Specifications

8.1 Environmental

Environment	Indoor, dry
Operation temperature	+32°F to +120°F (0°C to +49°C)
Storage temperature	+14°F to +131°F (-10°C to +55°C)
Relative humidity	Up to 95%, non-condensing
Protection class per IEC 61529	IP 30
City Tie	
Operating temperature	+32°F to +120°F (0°C to +49°C)
Storage temperature	-4°F to +140°F (-20°C to +60°C)
Relative humidity	Up to 93%, non-condensing

8.2 Electrical

Mains power supply (primary)	
– Supervision	Supervised for the presence of AC power
– Voltage	120 VAC, 60 Hz, 1.1 A maximum, or 240 VAC, 50 Hz, 0.6 A maximum

Power supply (secondary) with battery backup	
– Voltage	24 VDC
– Supervision	Supervised for the presence of AC power
– Current consumption (standby)	1.25 A maximum
– Current consumption (alarm)	5 A maximum 1.0 A maximum shared between panel and SLC(s) <ul style="list-style-type: none"> – Panel ≤ 250 mA – SLC 1 = 60 mA/card + 220 mA/loop maximum – SLC 2 = 60 mA/card + 220 mA/loop maximum 4.0 A maximum shared between NACs, Option Bus, and AUX power <ul style="list-style-type: none"> – NACs (non-synchronized) <ul style="list-style-type: none"> – NAC 1 = 2.5 A maximum – NAC 2 = 2.5 A maximum – NACs (synchronized) <ul style="list-style-type: none"> – NAC 1 + NAC 2 in total = 2.75 A maximum – Option Bus = 0.5 A maximum – AUX/FWR = 0.5 A maximum – AUX/RST = 0.5 A maximum

Power supply (secondary) with battery backup	
– Battery capacity	7.0 Ah minimum, 40 Ah maximum
– Charge current	2.0 A maximum
– Fuse	15 A blade-type
– Suitable battery type	Two 12 VDC in series (7 Ah or 18 Ah in enclosure, 24 Ah or 38 Ah in additional battery box) Recommended Manufacturers: POWER SONIC: PS-1270, PS-12170, PS-12180 YUASA: NP7-12, NPG18-12
– Maintenance	Replace batteries when they fail the Battery Load test

Auxiliary power supply	
AUX/FWR Full Wave Rectified	500 mA at 24 V FWR (17 to 31 VRMS), non-switched, power-limited, unfiltered, non-supervised
AUX/RST Resettable	500 mA at 24 V FWR (17 to 31 VDC), switched, power-limited, filtered, non-supervised
Line impedance for ground fault detection (Option Bus, SLC, NAC, secondary power circuit, City Tie/Local Energy, AUX)	15 k Ω

Option Bus (OB)	
Voltage	Nominal 12 VDC, power-limited, supervised
Current	500 mA maximum
Configuration	1 Class B
Circuit wiring distance	4000 ft. (1219 m) maximum, depending on wire gage and connected devices

Notification appliance circuits (NACs)	
Mainboard NACs	Two (NAC 1 and NAC 2)
NAC power from panel	Nominal 24 V FWR (17 to 31 VRMS), regulated, power-limited, supervised 2.5 A per NAC, maximum current limited to overall 4.0 A shared among AUX power, Option BUS, and NACs
Line impedance	1.45 Ω maximum
Configuration	Two Class B or two Class A

Signaling line circuits (SLCs)	
Voltage	Nominal 39 VDC (29 VDC to 40 VDC), power-limited, supervised
Current	204 mA (per FPE-1000-SLC)
Circuit resistance	<50 Ω
Circuit capacitance	<1 ΩF
Circuit inductance	<1 mH
Configuration	1 or 2 Class B or 1 Class A or 1 Class X

City Tie	
Circuit resistance	65 Ω maximum
Wire gauge	12 AWG to 18 AWG (ISO 4 mm ² to 0.75 mm ²)
City Tie - Local Energy Mode	
Type of connection	In series
Alarm, trip coil	24 VDC
Alarm current	250 mA DC (momentary)
Supervisory/standby current	<50 mA DC
Trip coil resistance	14.5 Ω
Nominal coil voltage	3.65 VDC, power-limited, supervised
City Tie - Reverse Polarity Module	
Nominal voltage	Nominal 24 VDC (26.4 VDC maximum), power-limited, supervised
Output current	33 mA maximum
Supervisory/standby current	5 mA

Networking cards	
Current (per card)	FPE-1000-NE: 100 mA FPE-1000-NF: 170 mA FPE-1000-NW: 330 mA
Circuit wiring distance (actual length depends on connector quality)	FPE-1000-NE: 328 ft. (100 m) FPE-1000-NF: 6560 ft. (2000 m) or 10 db loss FPE-1000-NW: 3280 ft. (1000 m) maximum

8.3

Mechanical

Operating elements	
Six LEDs	Fire, Gas Alarm, Power, Supervisory, Silenced, and Trouble
Display	4-line x 20 character LCD display, backlit
Operation keys	Drill, Reset, Silence, and Acknowledge
Alphanumeric keypad	12 alphanumeric keys, escape, enter and navigation buttons (left, right, up, down)

Interfaces	
PSTN/DACT	2 lines, RJ45
Ethernet	1 x RJ45

Physical characteristics	
Mounting holes	3, on back
Cable entries	Triple knockouts (1/2, 3/4, and 1 in.)
Connections	Pluggable terminal blocks for AUX, Option Bus, SLC, NAC, Mainboard Relays, and City Tie
Wire gauge	12 AWG to 18 AWG (ISO 4 mm ² to 0.75 mm ²)
Material	Cold rolled steel, 19 gauge (1.2 mm)
Color	Red
Dimensions (W x H x D)	14.5 in. X 4.3 in. x 22.7 in. (36.8 cm x 10.9 cm x 57.7 cm)
Dimensions with trim ring (W x H x D) Semi-flush mounted (H recessed/H flush)	17.5 in. x 25.6 in x (44.5 cm x 65.0 cm) 3.25 in./1.05 in. (8.25 cm/2.7 cm)
Weight	
Enclosure	18.1 lb. (8,2 kg)
Keypad with support	9.9 oz. (280 g)
Complete panel (with one FPE-1000-SLC and FPE-1000-CITY each, without batteries)	25.8 lb. (11.7 kg)
Gross weight (including packaging and manuals, without batteries)	34.9 lb. (14.8 kg)

Notification appliance circuits (NACs)	
Mainboard NACs	Two (NAC 1 and NAC 2)

Notification appliance circuits (NACs)	
Selectable patterns	Steady Pulsing Temporal Code 3 Temporal Code 4 Wheelock System Sensor Gentex
Optional	Up to 4 FPP-RNAC-8A-4C, providing 16 NACs

Relays	
Mainboard relays	Three Form C relays programmable as alarm, trouble, supervisory, gas alarm, or activation by zone rated at 5 A, 30 VDC/10 A, 120 VAC not power-limited, resistive loads only
Optional	D7035/B Octal relay module, 8 form C outputs two units maximum with 8 relays each

Communication circuits	
Communication circuits	Phone line/IP connections (primary and secondary path) via central station receiver (2 x RJ45) Ethernet connections (1 x RJ45)
Reporting formats	ContactID, SIA3000, and Modem IIIa ² Conettix IP reporting
Baud rate	2400 bits/second
PSTN dialing types	Pulse only, tone and pulse, or tone only
PSTN test call frequency	4, 6, 24 hour, 7 or 28 days interval, individually programmable for each account
Ringer Equivalence Number (REN)	0.0B
FCC Registration number	<i>US:ESVAL00BFPA1000</i>
Compatible devices for PSTN?DACT circuit and Ethernet connection	D6600 Central Station Receiver

Networking cards	
FPE-1000-NE connector	CAT 5 minimum
FPE-1000-NF connector	Multi-mode fiber optic with LC connector 62.5 µm/125 µm fiber size 1270 nm to 1380 nm wavelength

Networking cards	
FPE-1000-NW connector	Twisted pair wire or CAT 5 cable (shielded or unshielded)

8.4

Panel Address Data

Default panel IP address	192.168.1.30 / 192.168.99.1
Default client IP address	192.168.99.2
Gateway	192.168.1.1
Subnet mask	255.255.255.0

9 Appendices

9.1 Abbreviations on the Control Panel Display

Abbreviation	Description
a / p	am (ante meridiem) / pm (post meridiem)
ACCNT	Account
ACK / Ack	Acknowledge, or Acknowledgement
Act.	Activation
Act. Fail	Activation Failure
ADDR / ADDRS	Address / Addresses
ALM	Alarm
Annuns	Annunciators
AUTO	Automatic
AUX / Aux	Auxiliary
AV	Alarm Verification
BATT / Batt	Battery
Calib.	Calibration
COMM	Communicator, or Communication
CONFIG	Configuration
Curr.	Current
D	Day Mode
DACT	Digital Alarm Communicator Transmitter
DAY SENSI	Day Sensitivities
Deact.	Deactivation
Dev.	Device
DIAG	Diagnostics
Dirt	Dirty
DRL	Drill
D-ZONE	Dual-zone
EOL	End Of Line Resistor
ERR	Error
ESC	Escape
Ext.	External
Fail	Failure
FREQ	Frequency

Abbreviation	Description
FRI	Friday
h	History Log
I/O	Input/output
INFO	Information
IP	Internet Protocol, or Internet Protocol address
Last prog	Last programmed date
MAX / Max	Maximum
MB	Mainboard
MIN	Minimum
Mins	Minutes
MOD	Module
MON	Monday
NAC	Notification Appliance Circuit
NC	Normally Closed
nEOL	no EOL
NO	Normally Open
OB	Option Bus
OC	Open Collector output
Overcurr.	Overcurrent
Overvolt.	Overvoltage
PAS	Positive Alarm Sequence
PIN	Personal Identification Number
Pls	Please
PNT LABEL	Point Label
Pri Acct	Primary Account
Proc Fail	Process Failure
PROG / Prog	Programming, or Programmed
PRT	Print
PSTN	Public Switched Telephone Network
PULLSTAT	Pull Station
RECONFIG	Reconfigure
RLY	Relay
RMT	Remote

Abbreviation	Description
RNAC	Remote NAC, or Option Bus NAC
RSD	Reset, Silence, Drill
RST	Restore
SAV	Saving
SAT	Saturday
Sec Acct	Secondary Account
SECOND	Secondary
SIL	Silenceable
SLC	Signaling Line Circuit
SPVR, SUPERVSR	Supervisory
SUN	Sunday
SW	Software
SYS	System
Temp. 3	Temporal Code 3
THU	Thursday
TUE	Tuesday
TRB	Trouble
Ver.	Version
VERIFY	Verification
Volt.	Voltage
w	Walk Test Log
WED	Wednesday
WT	Walk Test

9.2 Default Programming

Site Data

Banner, Language, IP and Printer	
Banner (1. line)	BOSCH
Banner (2. line)	Fire System
Panel ID	[empty]
Panel IP address	192.168.1.30
Gateway	192.168.1.1
Netmask	255.255.255.0
Fire Network ID	1

Local Panel Settings	
AUX power reset	Enabled
External power supply	Disabled
PIN Codes and Authority Levels	
Level 1	No PIN (History, Date/time)
Level 2 PIN (maintenance)	2222 (Walk test, Test, Bypass)
Level 3 PIN (programming)	3333
PIN for reset/silence/drill	1111, disabled
Web operator Pin	0000 (user name: "operator", case sensitive)
Time Schedule	
Enable daylight savings	Disabled (Start 1st Sunday in March, End 3rd Sunday in October)
Detector day sensitivity enabled	Disabled Mo/Tu/We/Th/Fr/Sa/Su From 7:00 am, To 5:30 pm
Timer Settings	
Global delay mode	AV/PAS/Pre-signal
Day mode	No delay
Silence inhibit	0 min
Investigation time	180 s
Alarm verification delay	60 s
Sequential reset delay	5 s
AC failure delay	3 h
Waterflow delay	90 s/ Waterflow silenceable: disabled
Auto silence delay	10 min/ Enable: disabled
Sandwich alarm delay	5 min/ Enable: disabled
Dual zone first alarm reset	60 s/ First alarm latching: enabled
Language, Time Format and Units	
Language	English
Timer format	12 h
Units	°F, ft
Function Settings	
Silence	Audible only
Supervisory latching	Enabled

Enable silence	Enabled
Enable drill	Enabled

Printer Settings	
Printer IP address	[empty]
Printer IP port	21
Printer FTP user	[empty]
Printer FTP password	[empty]
Event printing enable	Disabled
Event print delay	5 s

SLC Configuration

Device Type	Programming Option	Default Setting
SLC 1	Installed	Installed: enabled
	Address	0 (fixed)
	Topology	2 x class B
	Label	[empty]
	Bypassed	Disabled
SLC 2	Installed	Installed: disabled
	Address	0 (fixed)
	Topology	2 x class B
	Label	[empty]
	Bypassed	Disabled

Device Type	Programming Option	Default Setting	
FAP-440-T FAP-440-TC FAP-440-DT FAP-440-DTC [SMOKE-M]	Zones	No zone assigned	
	Delay mode	No delay	
	Device LED flashing	Enabled (flashing when polling)	
	Bypassed	Disabled	
	Point type	Fire automatic	
	Alarm mode	Multi-combined	
	Set point (Smoke)	2.50 %/ft (8.20 %/m)	
	Set point (Heat)	135°F (57°C)	
	RoR	Enabled	
	Label	[empty]	
	Day alarm mode	Multi-combined	
	Day sensitivity (Smoke)	2.50 %/ft (8.20 %/m)	
	Day sensitivity (Heat)	135°F (57°C)	
	RoR	Enabled	
	Smoke sensor (Multi-separated):		
	- Smoke label	[empty]	
	- Smoke point type	Generic	
FAP-325-V2F FAP-440 FAP-440-D [SMOKE-P]	Zones	No zone assigned	
	Delay mode	No delay	
	Device LED flashing	Enabled (flashing when polling)	
	Point type	Fire automatic	
	Set point	2.50 %/ft (8.20 %/m)	
	Label	[empty]	
	Day sensitivity	2.50 %/ft (8.20 %/m)	
	Bypassed	Disabled	
FAP-325 [SMOKE-P]	Zones	No zone assigned	
	Delay mode	No delay	
	Point type	Fire automatic	
	Set point	2.50 %/ft (8.20 %/m)	
	Label	[empty]	
	Day sensitivity	2.50 %/ft (8.20 %/m)	
	Bypassed	Disabled	

Device Type	Programming Option	Default Setting
FAH-325 [HEAT]	Zones	No zone assigned
	Delay mode	No delay
	Point type	Fire automatic
	Set point	135°F (57°C)
	Label	[empty]
	Day sensitivity	135°F (57°C)
	Bypassed	Disabled
FAH-440 [HEAT]	Zones	No zone assigned
	Delay mode	No delay
	Device LED flashing	Enabled (flashing when polling)
	Point type	Fire automatic
	Set point	135°F (57°C)
	RoR	Enabled
	Label	[empty]
	Day sensitivity	135°F (57°C)
	RoR	Enabled
	Bypassed	Disabled
	RTI rating	Standard
FAI-325 [SMOKE-I]	Zones	No zone assigned
	Delay mode	No delay
	Point type	Fire automatic
	Set point	0.85 %/ft (2.80 %/m)
	Label	[empty]
	Day sensitivity	0.85 %/ft (2.80 %/m)
	Bypassed	Disabled
FAA-325-B6S [SND-BASE]	Zones	Global alarm zone (226) assigned
	Label	[empty]
	NAC pattern	Temporal Code 3
	Bypassed	Disabled
	Silenceable	Enabled
	Activated by host	Disabled

Device Type	Programming Option	Default Setting
FAD-325-DH FAD-325-V2F-DH [SMOKE-D]	Zones	No zone assigned
	Delay mode	No delay
	Point type	Fire automatic
	Set point	2.00 %/ft (6.55 %/m)
	Label	[empty]
	Day sensitivity	2.00 %/ft (6.55 %/m)
	Detector bypassed	Disabled
	FAD-RLY Duct relay:	
	– FAD-RLY Installed	Disabled
	– Zones	Global alarm zone (226) assigned
	– FAD-RLY label	[empty]
	– FAD-RLY bypassed	Disabled
	FLM-325-I4 [CONT-MOD]	Delay mode
Device label		[empty]
Point type		Fire alarm manual
Input type		NO with EOL
Zones		No zone assigned
Bypassed		Disabled
FLM-325-I4-A FLM-325-I4-AI [CONT-MOD]	Wiring type	
	– Class B	Enabled
	– Class A	Disabled
	Delay mode	No delay
	Device label	[empty]
	Point type	Fire alarm manual
	Input type	NO with EOL
	Zones	No zone assigned
	Bypassed	Disabled

Device Type	Programming Option	Default Setting
FLM-325-2I4 [CONT-MOD]	Input 1/Input 2 each:	
	- Delay mode	No delay
	- Device label	[empty]
	- Point type	Fire alarm manual
	- Input type	NO EOL
	- Zones	No zone assigned
	- Label	[empty]
	- Bypassed	Disabled
FLM-325-CZM4 [CONVZ-MOD]	Zones	No zone assigned
	Delay mode	No delay
	Point type	Fire automatic
	Label	[empty]
	Bypassed	Disabled
FLM-325-2R4 FLM-325-2R4-2A FLM-325-2R4-2AI FLM-325-2R4-8A FLM-325-2R4-8AI [RELAY-MOD]	Device label	[empty]
	Relay 1/Relay 2 each:	
	- Relay label	[empty]
	- Zones	Global alarm zone (226) assigned
	- Bypassed	Disabled
	- Sequential reset	Disabled
	- Drillable	Disabled
D328A [RELAY-MOD]	Label	[empty]
	Zones	Global alarm zone (226) assigned
	Bypassed	Disabled
	Sequential reset	Disabled
	Drillable	Disabled
FLM-325-N4 FLM-325-NA4 FLM-325-NAI4 [NAC-MOD]	Zones	Global alarm zone (226) assigned
	Label	[empty]
	NAC pattern	Steady
	Bypassed	Disabled
	Silenceable	Enabled

Mainboard

Relays

Relay 1	Relay type	Alarm
	Zones	Global alarm zone (226) assigned
	Drillable	Disabled
	Ext. signaling	Disabled
	Bypassed	Disabled
	Energized in normal	Disabled
	Sequential reset	Disabled
	Label	Mainboard relay 1
Relay 2	Relay type	Trouble
	Zones	Global trouble zone (227) assigned
	Drillable	Disabled
	Ext. signaling	Disabled
	Bypassed	Disabled
	Energized in normal	Enabled
	Sequential reset	Disabled
	Label	Mainboard relay 2
Relay 3	Relay type	Supervisory
	Zones	Global supervisory zone (228) assigned
	Drillable	Disabled
	Ext. signaling	Disabled
	Bypassed	Disabled
	Energized in normal	Disabled
	Sequential reset	Disabled
	Label	Mainboard relay 3
NACs		
NAC 1/ NAC 2	NAC pattern	Steady
	Zones	Global alarm zone (226) assigned
	Silenceable	Enabled
	Bypassed	Disabled
	Label	Mainboard NAC 1 / Mainboard NAC 2
City Tie		
	City Tie board installed	Disabled
	Activated by events from	Panel wide

City Tie 1	Configuration	Alarm
	Silenceable	Disabled
	Disabled	Disabled
	Bypassed	Disabled
	Label	City Tie 1 ALM
City Tie 2	Configuration	Supervisory
	Silenceable	Disabled
	Disabled	Disabled
	Bypassed	Disabled
	Label	City Tie 2 SUP

Option Bus

LED Annunciators		
	Zone 1-128	Enabled
LCD Annunciators/Command Centers		
	No presettings	
D7035 Octal Relay Modules, D7048 Octal Driver Modules		
	Installed	Disabled
	Device label	[empty]
	Zones	Global Alarm Zone (226) assigned
	Drillable	Disabled
	Ext.signaling	Disabled
	Bypassed	Disabled
	Energized in normal	Disabled
	Sequential reset	Disabled
	Label	[empty]
FPP-RNAC-8A-4C Remote NAC Power Supplies		
RNAC 1/ RNAC 2/ RNAC 3/ RNAC 4	Installed	Disabled
	Device label	[empty]
	Zones	Global Alarm Zone (226) assigned
	NAC pattern	Steady
	Silenceable	Enabled
	Bypassed	Disabled
	Label	[empty]

Reporting

Primary/Secondary Account	
Account number	[empty]
Reporting format	SIA-DCS 300 no Text
Auto test time	2:00 am
Auto test interval	24 hours
Maximum attempts	10
Selection PSTN/IP/Disable	PSTN
PSTN	
Phone number	[empty]
IP Reporting Conettix	
Receiver IP address	[empty]
Port number	7700
Polling interval	240 s
Acknowledge wait time	10 s
Anti-replay	Enabled
Encryption	Disabled
Key string (0-9, A-F, 32 characters)	11 11

PSTN Communicator Settings	
Dialing type	DTMF
Line 1 Enable	Disabled
Line 2 Enable	Disabled
Redial interval	10 s

Steering	
For all report steering groups	Secondary as backup
Report events/operations from:	Panel wide

E-mail Settings	
	No presettings

Zones

Global Zones	
Zone number	Zone text
226	Global Fire Alarm
227	Global Trouble

228	Global Supervisory
229	Global Alarm Verification
230	Global Pre-signal
231	Global PAS
232	Global Reset
233	Global Gas Alarm
234	Waterflow

All global zones are assigned to a default NAC pattern. The networked option is enabled for all global zones.

Software Zones (Programmable Local 1-128; Programmable Group 129-225)

Zone No.	Local: 1 - 128; Group: 129-225
Label	[empty]
NAC Pattern	Default
Bypassed	Disabled
Counting	1
Floor	0
Set Default	Reset

Dual-zones		
Group 1/ Group 2/ Group 3	Dual-zone pair 1	No zones assigned
	Dual-zone pair 2	No zones assigned
	Dual-zone pair 3	No zones assigned
	Dual-zone pair 4	No zones assigned

Floors		
Floor 1 to 32	Label	[empty]
	Sandwich alarm	Disabled

Networking

	No presettings
--	----------------

9.3

Compatible SLC Devices for Retrofit Projects

The system allows for programming the following devices for retrofit projects:

Type Number	Device Group Type	Description
D322A	HEAT	Analog Heat Detector Head
D323A	SMOKE-P	Analog Photoelectric Smoke Detector Head

Type Number	Device Group Type	Description
D324A	SMOKE-I	Analog Ionization Detector Head
D326A	CONT-MOD	Analog Point Contact Module
D327A	NAC-MOD	Analog NAC Module
D331A	SMOKE-D	Analog Duct Smoke Detector

9.4 Reporting Codes

Contact ID reporting codes layout and abbreviations			
Position	Placeholder	Designation	
1	####	Account number	<p> 1 2 3 4 5 #### Q XYZ CC AAA 0001 1 116 00 023 Contact ID Layout (Example in the Bottom Row) </p>
2	Q	Event qualifier – 1 = new event – 3 = restore – 6 = previously reported condition still present (status report)	
3	XYZ	Event code	
4	CC	Circuit or Ou for user level	

Tab. 9.47: Contact ID reporting codes layout and abbreviations

SIA-DCS reporting codes layout and abbreviations			
Position	Placeholder	Designation	
1	TT	Data type code	<p> 1 2 TT CAAA FA 1063 SIA-DCS Layout (Example in the Bottom Row) </p>
2	CAAA	Address number (circuit and address for point event, or 000u for user level)	

Tab. 9.48: SIA-DCS reporting codes layout and abbreviations

Modem IIIa ² Receiver Output Explanation		
When the Modem IIIa ² reporting format is used with a Bosch Security Systems, Inc. receiver, the receiver output is in accordance with the following report layout:		
Placeholder	Designation	dd/dd tt:tt Lxx ACCT aaaa EEEEEEEEEEE +++ ACCT #### AREA=C POINT=AAA Modem IIIa ² layout
dd/dd	Date	
tt:tt	Time	
Lxx	Line number (receiver)	
ACCT ####	Account number	
AREA=C	Circuit	
EEEEEEEEEEE	Event	
POINT=AAA	Address	

Tab. 9.49: Modem IIIa² receiver output explanation

For further reporting address information, see *Address Assignment*, page 36 and *Mainboard Address Assignment*, page 39.

List of Reporting Codes

For complete reporting layout and explanation, see the figures above for Contact ID Reporting Codes Layout and Abbreviations, SIA-DCS Reporting Codes Layout and Abbreviations, and Modem IIIa² Receiver Output Explanation. For Modem IIIa² reporting codes the following chart only lists the event text.

Report	Index	Contact ID	SIA-DCS	Modem IIIa2 (Event)
Fire Alarm General	1	#### 1 110 CC AAA	FA CAAA	FIRE ALARM
Fire Alarm Smoke	2	#### 1 111 CC AAA	FA CAAA	FIRE ALAR SMOKE DETCTOR
Fire Alarm Duct	3	#### 1 116 CC AAA	FA CAAA	FIRE ALARM SMOKE DETCTOR
Fire Alarm Heat	4	#### 1 114 CC AAA	FA CAAA	FIRE ALARM HIGH TEMP. SENSOR
Fire Alarm Manual	5	#### 1 115 CC AAA	FA CAAA	FIRE ALARM
Fire Alarm Waterflow	6	#### 1 113 CC AAA	SA CAAA	FIRE ALARM WATERFLOW POINT
Fire Supervisory	7	#### 1 200 CC AAA	SS CAAA	FIRE SUPERVISION
Gas Alarm	8	#### 1 151 CC AAA	GA CAAA	FIRE SUPERVISION
Fire Alarm Restore General	17	#### 3 110 CC AAA	FH CAAA	FIRE ALARM REST
Fire Alarm Restore Smoke	18	#### 3 111 CC AAA	FH CAAA	FIRE ALM RESTOR SMOKE DETCTOR
Fire Alarm Restore Duct	19	#### 3 116 CC AAA	FH CAAA	FIRE ALM RESTOR SMOKE DETCTOR
Fire Alarm Restore Heat	20	#### 3 114 CC AAA	FH CAAA	FIRE ALARM RESTOR HIGH TEMP. SENSOR
Fire Alarm Restore Manual	21	#### 3 115 CC AAA	FH CAAA	FIRE ALM RESTOR
Fire Alarm Restore Waterflow	22	#### 3 113 CC AAA	SH CAAA	FIRE ALM RESTOR WATERFLOW POINT
Fire Supervisory Restore	23	#### 3 200 CC AAA	SR CAAA	FIRE SUPRV REST
Gas Alarm Restore	24	#### 3 151 CC AAA	GH CAAA	FIRE SUPRV REST
Fire Bypassed	32	#### 1 571 CC AAA	FB CAAA	POINT BYPASS FIRE POINT
Waterflow Bypassed	33	#### 1 571 CC AAA	WB CAAA	POINT BYPASS WATERFLOW POINT
Supervisory Bypassed	34	#### 1 571 CC AAA	FB CAAA	POINT BYPASS SUPERVISORY POINT
Gas Bypassed	35	#### 1 570 CC AAA	GB CAAA	POINT BYPASS
General Bypassed	36	#### 1 570 CC AAA	FB CAAA	POINT BYPASS
Fire Unbypassed	48	#### 3 571 CC AAA	FU CAAA	BYPASS RESTORE FIRE POIN
Waterflow Unbypassed	49	#### 1 571 CC AAA	WU CAAA	BYPASS RESTORE WATERFL. POINT
Supervisory Unbypassed	50	#### 1 571 CC AAA	FU CAAA	BYPASS RESTORE SUPERVISORY
Gas Unbypassed	51	#### 1 570 CC AAA	GU CAAA	BYPASS RESTORE
General Unbypassed	52	#### 1 570 CC AAA	FU CAAA	BYPASS RESTORE

Report	Index	Contact ID	SIA-DCS	Modem IIIa2 (Event)
General Trouble	64	#### 1 373 CC AAA	ET CAAA	FIRE TROUBLE
AC Power Failure [Mainboard]	65	#### 1 301 00 000	AT 0000	AC FAILURE
AC Power Failure [Point]	65	#### 1 342 CC AAA	AT CAAA	AC FAILURE
AUX Power Failure	66	#### 1 300 CC AAA	ET CAAA	EQUIPMENT FAIL
Battery Charger Failure	67	#### 1 302 00 000	ET 0000	EQUIPMENT FAIL
Battery Failure	68	#### 1 302 CC AAA	YT CAAA	BATTERY LOW
Battery Relay Failure	69	#### 1 320 00 000	ET 0000	EQUIPMENT FAIL
Earth Ground Failure	70	#### 1 310 00 000	ET 0000	TROUBLE REPORT GROUND FAULT
EOL Open	71	#### 1 300 CC AAA	ET CAAA	EQUIPMENT FAIL
EOL Short	72	#### 1 300 CC AAA	ET CAAA	EQUIPMENT FAIL
NAC Over Current	73	#### 1 300 CC AAA	YI CAAA	EQUIPMENT FAIL
Dialer Trouble	74	#### 1 300 CC AAA	ET CAAA	EQUIPMENT FAIL
Phone Line Trouble [Line 1]	75	#### 1 351 00 000	LT 0000	PHONE LINE FAIL PHONE LINE=1
Phone Line Trouble [Line 2]	75	#### 1 352 00 000	LT 0000	PHONE LINE FAIL PHONE LINE=2
IP Reporting Path Failure	76	#### 1 356 CC AAA	ET CAAA	NETWORK FAIL
Communication to Primary Account Failure	77	#### 1 350 CC AAA	YC CAAA	COMM FAI
Communication to Secondary Account Failure	78	#### 1 350 CC AAA	YC CAAA	COMM FAI
Short on OUT Connections (for Class B)	79	#### 1 372 CC 000	ET CAAA	PT BUS TROUBLE
Short on IN Connections (for Class B)	80	#### 1 372 CC 000	ET CAAA	PT BUS TROUBLE
Short	81	#### 1 372 CC AAA	ET CAAA	FIRE TROUBLE
Open	82	#### 1 371 CC AAA	ET CAAA	FIRE TROUBLE
Circuit Open	83	#### 1 371 CC 000	ET CAAA	PT BUS TROUBLE
Low Voltage	84	#### 1 370 CC 000	ET CAAA	PT BUS TROUBLE
High Current	85	#### 1 370 CC 000	YI CAAA	PT BUS TROUBLE
External Power	86	#### 1 300 CC 000	ET CAAA	FIRE TROUBLE
Circuit Type Mismatch	87	#### 1 300 CC 000	ET CAAA	PT BUS TROUBLE
Device Internal	88	#### 1 380 CC AAA	ET CAAA	FIRE TROUBLE
Heat Sensor Problems	89	#### 1 380 CC AAA	ET CAAA	FIRE TROUBLE
Smoke Sensor Problems	90	#### 1 380 CC AAA	ET CAAA	FIRE TROUBLE
Multi Sensor Problems	91	#### 1 380 CC AAA	ET CAAA	FIRE TROUBLE

Report	Index	Contact ID	SIA-DCS	Modem IIIa2 (Event)
Device Missing	92	#### 1 380 CC AAA	EM CAAA	MISSING FIRE
New Device	93	#### 1 380 CC AAA	ET CAAA	FIRE TROUBLE
Wrong Device Type	94	#### 1 380 CC AAA	ET CAAA	FIRE TROUBLE
Sensor Dirty	95	#### 1 393 CC AAA	AS CAAA	ANALOG SERVICE SENSOR DIRTY
Sensor Calibration Failed	96	#### 1 392 CC AAA	AS CAAA	FIRE TROUBLE
Device Initialization Failed	97	#### 1 380 CC AAA	ET CAAA	FIRE TROUBLE
Reserve Polarization (Wrong Connection)	98	#### 1 380 CC AAA	ET CAAA	FIRE TROUBLE
Short Circuit Isolator	99	#### 1 380 CC AAA	ET CAAA	FIRE TROUBLE
Double Address	100	#### 1 380 CC AAA	ET CAAA	FIRE TROUBLE
Local Energy Activated	101	#### 1 300 CC AAA	ET CAAA	FIRE TROUBLE
Local Energy Activation Failed	102	#### 1 300 CC AAA	ET CAAA	FIRE TROUBLE
Unverified	103	#### 1 378 CC AAA	FG CAAA	UNVRFD EVT-FIR CROSS POINT
Switch Board Missing	104	#### 1 330 CC AAA	EM CAAA	EQUIPMENT FAIL
NIC Port Disconnect	105	#### 1 330 CC AAA	ET CAAA	EQUIPMENT FAIL
Wiring Loop Open	106	#### 1 371 CC AAA	ET CAAA	EQUIPMENT FAIL
Network Panel Missing	107	#### 1 300 CC AAA	ET CAAA	EQUIPMENT FAIL
Double Panel Address	108	#### 1 300 CC AAA	ET CAAA	EQUIPMENT FAIL
Network Configuration Conflict	109	#### 1 300 CC AAA	ET CAAA	EQUIPMENT FAIL
Network Panel New	110	#### 1 300 CC AAA	ET CAAA	EQUIPMENT FAIL
Wrong Address Trouble (for 440)	111	#### 1 380 CC AAA	ET CAAA	EQUIPMENT FAIL
CO Lifetime Trouble (for 440)	112	#### 1 380 CC AAA	ET CAAA	EQUIPMENT FAIL
CO Fail Trouble (for 440)	113	#### 1 380 CC AAA	ET CAAA	EQUIPMENT FAIL
Device Internal Trouble (for 440)	114	#### 1 380 CC AAA	ET CAAA	EQUIPMENT FAIL
Switch Board New	115	#### 1 330 CC AAA	ET CAAA	EQUIPMENT FAIL
Wiring Loop Type	116	#### 1 300 CC AAA	ET CAAA	EQUIPMENT FAIL
Control Conflict	117	#### 1 300 CC AAA	ET CAAA	EQUIPMENT FAIL
Panel Event Synch	118	#### 1 300 CC AAA	ET CAAA	EQUIPMENT FAIL
General Trouble Restore	128	#### 3 373 CC AAA	ER CAAA	FIRE TBL RESTOR
AC Power Restore [Mainboard]	129	#### 3 301 00 000	AR 0000	AC RESTORAL
AC Power Restore [Point]	129	#### 3 342 CC AAA	AR CAAA	AC RESTORAL
AUX Power Restore	130	#### 3 300 CC AAA	ER CAAA	EQUIP RESTORAL
Battery Charger Restore	131	#### 3 302 00 000	ER 0000	EQUIP RESTORAL

Report	Index	Contact ID	SIA-DCS	Modem IIIa2 (Event)
Battery Restore	132	#### 3 302 CC AAA	YR CAAA	BATTERY RESTORAL
Battery Relay Restore	133	#### 3 320 00 000	ER 0000	EQUIP RESTORAL
Earth Ground Restore	134	#### 3 310 00 000	ER 0000	RESTORAL REPORT GROUND FAULT
EOL Open Restore	135	#### 3 300 CC AAA	ER CAAA	EQUIP RESTORAL
EOL Short Restore	136	#### 3 300 CC AAA	YJ CAAA	EQUIP RESTORAL
NAC Over Current Restore	137	#### 3 300 CC AAA	ER CAAA	EQUIP RESTORAL
Dialer Restore	138	#### 3 300 CC AAA	ER CAAA	EQUIP RESTORAL
Phone Line Restore [Line 1]	139	#### 3 351 00 000	LR 0000	PHONE RESTORAL PHONE LINE=1
Phone Line Restore [Line 2]	139	#### 3 352 00 000	LR 0000	PHONE RESTORAL PHONE LINE=2
IP Reporting Path Restore	140	#### 3 356 CC AAA	ER CAAA	NETWORK RESTORE
Communication to Primary Account Restore	141	#### 3 350 CC AAA	YK CAAA	COMM FAIL RESTR
Communication to Secondary Account Restore	142	#### 3 350 CC AAA	YK CAAA	COMM FAIL RESTR
Short on OUT Connections (for Class B) Restore	143	#### 3 372 CC 000	ER CAAA	PT BUS RESTORAL
Short on IN Connections (for Class B) Restore	144	#### 3 372 CC 000	ER CAAA	PT BUS RESTORAL
Short Restore	145	#### 3 372 CC AAA	ER CAAA	FIRE TBL RESTOR
Open Restore	146	#### 3 371 CC AAA	ER CAAA	FIRE TBL RESTOR
Circuit Open Restore	147	#### 3 371 CC 000	ER CAAA	PT BUS RESTORAL
Low Voltage Restore	148	#### 3 370 CC 000	ER CAAA	PT BUS RESTORAL
High Current Restore	149	#### 3 370 CC 000	YJ CAAA	PT BUS RESTORAL
External Power Restore	150	#### 3 300 CC 000	ER CAAA	FIRE TBL RESTOR
Circuit Type Mismatch Restore	151	#### 3 300 CC 000	ER CAAA	PT BUS RESTORAL
Device Internal Restore	152	#### 3 380 CC AAA	ER CAAA	FIRE TBL RESTOR
Heat Sensor Restore	153	#### 3 380 CC AAA	ER CAAA	FIRE TBL RESTOR
Smoke Sensor Restore	154	#### 3 380 CC AAA	ER CAAA	FIRE TBL RESTOR
Multi Sensor Restore	155	#### 3 380 CC AAA	ER CAAA	FIRE TBL RESTOR
Device Missing Restore	156	#### 3 380 CC AAA	EN CAAA	FIRE TBL RESTOR
New Device Restore	157	#### 3 380 CC AAA	ER CAAA	FIRE TBL RESTOR
Wrong Device Type Restore	158	#### 3 380 CC AAA	ER CAAA	FIRE TBL RESTOR
Sensor Dirty Restore	159	#### 3 393 CC AAA	AN CAAA	ANALOG RESTORE SENSOR DIRTY
Sensor Calibration Restore	160	#### 3 392 CC AAA	AN CAAA	FIRE TBL RESTOR

Report	Index	Contact ID	SIA-DCS	Modem IIIa2 (Event)
Device Initialization Restore	161	#### 3 380 CC AAA	ER CAAA	FIRE TBL RESTOR
Reserve Polarization (Wrong connection) Restore	162	#### 3 380 CC AAA	ER CAAA	FIRE TBL RESTOR
Short Circuit Isolator Restore	163	#### 3 380 CC AAA	ER CAAA	FIRE TBL RESTOR
Double Address Restore	164	#### 3 380 CC AAA	ER CAAA	FIRE TBL RESTOR
Switch Board Missing Restore	165	#### 3 330 CC AAA	EN CAAA	EQUIPMENT RESTORAL
NIC Port Disconnect Restore	166	#### 3 330 CC AAA	ER CAAA	EQUIPMENT RESTORAL
Wiring Loop Open Restore	167	#### 3 371 CC AAA	ER CAAA	EQUIPMENT RESTORAL
Network Panel Missing Restore	168	#### 3 300 CC AAA	ER CAAA	EQUIPMENT RESTORAL
Double Panel Address Restore	169	#### 3 300 CC AAA	ER CAAA	EQUIPMENT RESTORAL
Network Configuration Conflict Restore	170	#### 3 300 CC AAA	ER CAAA	EQUIPMENT RESTORAL
Panel New Restore	171	#### 3 300 CC AAA	ER CAAA	EQUIPMENT RESTORAL
Wrong Address Restore (for 440)	172	#### 3 380 CC AAA	ER CAAA	EQUIPMENT RESTORAL
CO Lifetime Restore (for 440)	173	#### 3 380 CC AAA	ER CAAA	EQUIPMENT RESTORAL
CO Fail Restore (for 440)	174	#### 3 380 CC AAA	ER CAAA	EQUIPMENT RESTORAL
Switch Board New Restore	176	#### 3 330 CC AAA	ER CAAA	EQUIPMENT RESTORAL
Wiring Loop Type Restore	177	#### 3 300 CC AAA	ER CAAA	EQUIPMENT RESTORAL
Control Conflict Restore	178	#### 3 300 CC AAA	ER CAAA	EQUIPMENT RESTORAL
Panel Event Synch Restore	179	#### 3 300 CC AAA	ER CAAA	EQUIPMENT RESTORAL
Reset	192	#### 1 305 CC 000	OR 000u	SENSOR RESET
Silence	193	#### 1 912 0u 000	FL 000u	ALARM SILENCED
Drill Start	194	#### 1 604 0u 000	FI 000u	FIRE WALK START
Test Start	195	#### 1 607 0u 000	TS 000u	WALK TEST START
Manual Communicator Test	196	#### 1 601 CC AAA	RX CAAA	TEST REPORT
Normal Auto Test	197	#### 1 602 CC AAA	RP CAAA	TEST REPORT
Off-normal Auto Test	198	#### 1 608 CC AAA	YX CAAA	TEST OFF-NORMAL
Remote Programming Successful	199	#### 1 412 0u 000	RS 000u	RAM ACCESS OK
Local Programming Start	200	#### 1 607 0u 000	LB 000u	WALK TEST START
Remote Programming Unsuccessful	201	#### 1 413 0u 000	RU 000u	RAM ACCESS FAIL
Drill End	226	#### 1 604 0u 000	FK 000u	FIRE WALK END
Test End	227	#### 1 607 0u 000	TE 000u	WALK TEST END

See also

– *Address Assignment, page 36*

- *Mainboard Address Assignment, page 39*

9.5 FPA-1000-UL Operating Instructions Sheet

This section is a copy of the *Operating Instruction Sheet* (P/N F.01U.075.632) supplied with the FPA-1000-UL Fire Panel. The original document must be framed and mounted in view adjacent to the FACP.

Local Service Representative:
Address:
Phone:

Understanding the Built-in Keypad

Six light-emitting diodes (LEDs) show fire alarm, gas alarm, power, supervisory, silence and trouble conditions. The built-in keypad can be used for total system control and programming. The alphanumeric keys are used to enter text information. The escape, enter and arrow keys (left, right, up, down) for menu navigation. The 4-line x 20 character alphanumeric LCD display shows programmed device point information. Four keys enable:

- [DRILL]: Turns on all unbypassed NACs and drillable relay outputs.
- [RESET]: Turns off the piezo; resets all input points and outputs to normal status.
- [SILENCE]: Quiets the bells/sirens for an alarm or trouble condition.
- Acknowledge [ACK]: Turns off the piezo and starts the investigation timer after a PAS activation or the trouble reminder for trouble events, if configured.

A built-in piezo provides an audible indication of the system status.

The panel offers three different programmable authority levels. The PIN needed for authority levels 2 and 3 (and restricted Level 1 if programmed) is a four-digit code. After pressing the enter key, the user is prompted with the main menu and is able to press any shortcut key to perform the operations available. If the selected operation needs access to a higher authority level, the user is asked to enter the PIN.

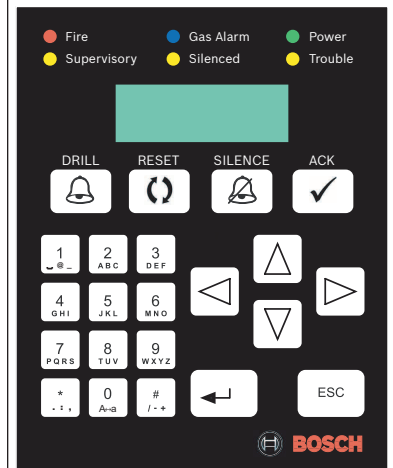

LED Operation	Piezo Operation ¹⁾	System Status ²⁾
Power Green	On	Silent If AC power is applied to the panel
	Flashing	Periodic beep (0.5 s on, 9.5 s off) When AC power fails and the unit operates from the battery power
	Off	Silent When no power (AC or battery) is applied
Fire Red LED	On	Continuous beep Whenever the system registers a fire alarm and is not reset ³⁾
	Off	Silent If no alarm is registered, and after resetting
Gas Alarm Blue	On	Periodic beep (0.5 s on, 1.5 s off) Whenever the system registers a gas alarm and is not reset ³⁾
	Off	Silent If no gas alarm is registered, and after resetting

LED Operation		Piezo Operation ¹⁾	System Status ²⁾
Supervisory Yellow	On	Periodic beep (0.5 s on, 3.5 s off)	When the system registers a supervisory condition
	Off	Silent	When no supervisory condition is registered
Silenced Yellow	On	Silent	When an alarm or trouble condition is silenced manually by the user, or if the system auto-silence timer expires
	Off	Silent	When no condition is silenced, or when the silenced condition is corrected
Trouble Yellow	On	Periodic beep (0.5 s on, 9.5 s off)	When the panel is initializing, or when the panel registers a trouble condition from a point or the panel, or when inputs or outputs or other elements are bypassed
	Flashing	Silent	When the panel is not operating, or when a walk test is in progress
	Off	Silent	When no trouble condition exists, or when the panel is resetting
<p>¹⁾ Short beep upon every key press.</p>			
<p>²⁾ When the panel is in the normal state (no alarm, supervisory or trouble condition), the display message is "System Normal" along with the current date and time. If PAS or Pre-signal is turned on, the screen indicates "SYSTEM NORMAL DAY".</p>			
<p>³⁾ Any off-normal conditions appear in groups classified as fire alarm, gas alarm, supervisory and trouble. Use the arrow keys to view events or conditions in the same group. Up and down keys move the user to the previous or next event, while left and right keys switch to other groups. The individual message display includes information about the point and the specific event or condition. The initial highest priority event always appears on top.</p>			

9.6 FPA-1000-V2 Operating Instructions Sheet

This section is a copy of the *Operating Instruction Sheet* (P/N F.01U.173.612) supplied with the FPA-1000-V2 Fire Panel. The original document must be framed and mounted in view adjacent to the FACP.

Local Service Representative:
Address:
Phone:

Understanding the Built-in Keypad

Six light-emitting diodes (LEDs) show fire alarm, gas alarm, power, supervisory, silence and trouble conditions. The built-in keypad can be used for total system control and programming . The alphanumeric keys are used to enter text information. The escape, enter and arrow keys (left, right, up, down) for menu navigation. The 4-line x 20 character alphanumeric LCD display shows programmed device point information. Four keys enable:

- [DRILL]: Turns on all unbypassed NACs and drillable relay outputs.
- [RESET]: Turns off the piezo; resets all input points and outputs to normal status.
- [SILENCE]: Quiets the bells/sirens for an alarm or trouble condition.
- Acknowledge [ACK]: Turns off the piezo and starts the investigation timer after a PAS activation or the trouble reminder for trouble events, if configured.

A built-in piezo provides an audible indication of the system status. The panel offers different programmable authority levels. The PIN needed for authority Levels 2 and 3 (and restricted Level 1 if programmed) is a four-digit code. After pressing the enter key, the user is prompted with the main menu and is able to press any shortcut key to perform the operations available. If the selected operation needs access to a higher authority level, the user is asked to enter the PIN.

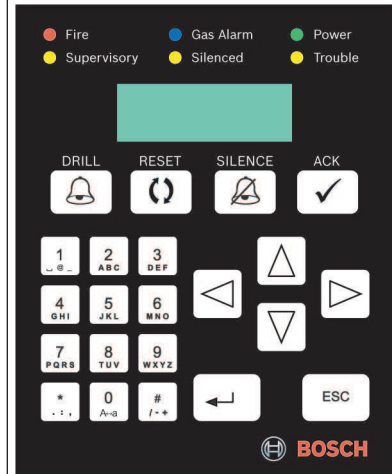

If networked, this panel can control or be controlled by other panels in the same network group.

LED Operation	Piezo Operation ¹⁾	System Status ²⁾
Power Green	On	Silent If AC power is applied to the panel
	Flashing	Periodic beep (0.5 s on, 9.5 s off) When AC power fails and the unit operates from the battery power
	Off	Silent When no power (AC or battery) is applied
Fire Red LED	On	Continuous beep Whenever the system registers a fire alarm and is not reset ³⁾
	Off	Silent If no alarm is registered, and after resetting
Gas Alarm Blue	On	Periodic beep (0.5 s on, 1.5 s off) Whenever the system registers a gas alarm and is not reset ³⁾
	Off	Silent If no gas alarm is registered, and after resetting

LED Operation		Piezo Operation ¹⁾	System Status ²⁾
Supervisory Yellow	On	Periodic beep (0.5 s on, 3.5 s off)	When the system registers a supervisory condition
	Off	Silent	When no supervisory condition is registered
Silenced Yellow	On	Silent	When an alarm or trouble condition is silenced manually by the user, or if the system auto-silence timer expires
	Off	Silent	When no condition is silenced, or when the silenced condition is corrected
Trouble Yellow	On	Periodic beep (0.5 s on, 9.5 s off)	When the panel is initializing, or when the panel registers a trouble condition from a point or the panel, or when inputs or outputs or other elements are bypassed
	Flashing	Silent	When the panel is not operating, or when a walk test is in progress
	Off	Silent	When no trouble condition exists, or when the panel is resetting
¹⁾ Short beep upon every key press.			
²⁾ When the panel is in the normal state (no alarm, supervisory or trouble condition), the display message is "System Normal" along with the current date and time. If PAS or Pre-signal is turned on, the screen indicates "SYSTEM NORMAL DAY".			
³⁾ Any off-normal conditions appear in groups classified as fire alarm, gas alarm, supervisory and trouble. Use the arrow keys to view events or conditions in the same group. Up and down keys move the user to the previous or next event, while left and right keys switch to other groups. The individual message display includes information about the point and the specific event or condition. The initial highest priority event always appears on top.			

Bosch Security Systems, Inc.

130 Perinton Parkway
Fairport, NY 14450
USA

www.boschsecurity.com

© Bosch Security Systems, Inc., 2017

Bosch Sicherheitssysteme GmbH

Robert-Bosch-Ring 5
85630 Grasbrunn
Germany

Free Manuals Download Website

<http://myh66.com>

<http://usermanuals.us>

<http://www.somanuals.com>

<http://www.4manuals.cc>

<http://www.manual-lib.com>

<http://www.404manual.com>

<http://www.luxmanual.com>

<http://aubethermostatmanual.com>

Golf course search by state

<http://golfingnear.com>

Email search by domain

<http://emailbydomain.com>

Auto manuals search

<http://auto.somanuals.com>

TV manuals search

<http://tv.somanuals.com>