



# Dinion IP

NWC-495-10P | NWC-495-20P



**BOSCH**

en Operating Instructions



# Table of Contents

<b>1</b>	<b>Introduction</b>	<b>15</b>
1.1	Type number overview	16
1.2	Unpacking	16
1.3	System requirements	17
1.4	Overview of functions	17
1.4.1	Wide dynamic range	18
1.4.2	Day/Night function	18
1.4.3	Power-over-Ethernet	18
1.4.4	Receiver	18
1.4.5	Video encoding	18
1.4.6	Tri Streaming	19
1.4.7	Recording	19
1.4.8	Multicast	19
1.4.9	Encryption	19
1.4.10	Configuration	19
1.4.11	Tampering recognition and motion detectors	19
1.4.12	Snapshots	20
1.4.13	Backup	20
1.4.14	Intelligent Video Motion Detection	20
<b>2</b>	<b>Connections</b>	<b>21</b>
2.1	Power	21
2.2	Network (and power)	22
2.3	Video service monitor	22
2.4	Alarm connector	23
<b>3</b>	<b>Mounting</b>	<b>24</b>
3.1	Lens mounting	24
3.2	Mounting the camera	25
<b>4</b>	<b>Quick set-up</b>	<b>26</b>
4.1	Back focus adjustment	26
4.2	Accessing and navigating quick set-up menu	27

4.2.1	How to use the navigation keys	27
4.2.2	Install menu	28
4.3	Adjustment procedure DC-iris Lens	28
4.4	Adjustment procedure Manual-iris Lens	29
4.5	Adjustment procedure Video-iris Lens	29
4.6	Install IP address submenu	29
4.7	Defaults	30

---

<b>5</b>	<b>Network connection</b>	<b>31</b>
5.1	System requirements	31
5.2	Establishing the connection	31
5.3	Secured network	33

---

<b>6</b>	<b>Operation via the browser</b>	<b>34</b>
6.1	Livepage	34
6.1.1	Processor load	34
6.1.2	Image selection	35
6.1.3	Digital I/O	35
6.1.4	System log / Event log	35
6.1.5	Saving snapshots	35
6.1.6	Recording video sequences	36
6.1.7	Running recording program	37
6.2	Recordings page	37
6.2.1	Selecting recordings	38
6.2.2	Controlling playback	38

---

<b>7</b>	<b>Configuration via the browser</b>	<b>41</b>
7.1	Settings	41
7.2	General Settings	43
7.2.1	Camera identification	43
7.2.2	Password protection	44
7.2.3	Language selection	45
7.2.4	Date and time	45
7.2.5	Time server	46
7.3	Display Settings	47
7.3.1	Display stamping	47

7.4	Encoder Settings	48
7.4.1	Selecting an encoder profile	48
7.4.2	Changing profiles	50
7.4.3	JPEG posting	53
7.5	Camera settings	55
7.5.1	ALC	55
7.5.2	Shutter/AGC	56
7.5.3	Day/Night	57
7.5.4	Enhance	58
7.5.5	Color	59
7.5.6	Back Light Compensation (BLC)	60
7.5.7	Installer options	61
7.6	Recording	61
7.6.1	Type	62
7.6.2	Storage information	62
7.7	iSCSI settings	63
7.7.1	iSCSI IP address	63
7.7.2	iSCSI LUN map	64
7.7.3	Target IP address	64
7.7.4	Target node	64
7.7.5	Target LUN	64
7.7.6	Target password	64
7.7.7	Initiator name	65
7.7.8	Initiator extension	65
7.7.9	Decoupling the drive used	65
7.7.10	Storage information	65
7.8	Partitioning	66
7.8.1	Creating a partition	66
7.8.2	Partition status	68
7.8.3	Editing a partition	68
7.8.4	Deleting partitions	71
7.9	Recording profile	71
7.10	Recording scheduler	74
7.10.1	Activating recording	75
7.10.2	Recording status	76
7.11	Alarm Settings	76
7.11.1	Alarm in	76

---

7.11.2	Alarm connections	77
7.12	VCA	79
7.12.1	Analysis	79
7.12.2	Analysis type	80
7.12.3	Motion detector	80
7.12.4	Sensitivity	81
7.12.5	Tamper detection	82
7.13	Alarm e-mail	84
7.13.1	Send alarm e-mail	84
7.13.2	Mail server IP address	84
7.13.3	Layout	85
7.13.4	Destination address	85
7.13.5	Sender name	85
7.13.6	Send e-mail for testing	85
7.14	Relay Settings	85
7.14.1	Alarm out	86
7.15	Service Settings	87
7.15.1	Network	87
7.15.2	Multicasting	90
7.15.3	Encryption	92
7.15.4	Version information	93
7.15.5	Livepage configuration	94
7.15.6	Licenses	96
7.15.7	Maintenance	97
7.16	Function test	99
<b>8</b>	<b>Connections between video servers</b>	<b>100</b>
8.0.1	Installation	100
8.0.2	Establishing the connection	100
8.0.3	Connect on alarm	100
8.0.4	Connecting with a Web browser	101
8.0.5	Closing the connection	101

---

<b>9</b>	<b>Operation with decoder software</b>	<b>102</b>
<hr/>		
<b>10</b>	<b>Maintenance</b>	<b>103</b>
10.1	Testing the network connection	103
10.2	Repairs	103
10.2.1	Transfer and disposal	103
<hr/>		
<b>11</b>	<b>Troubleshooting</b>	<b>104</b>
<hr/>		
<b>12</b>	<b>Specifications</b>	<b>106</b>
12.1	Dimensions (mm/inch)	108
12.2	Accessories	109
12.2.1	Recommended lenses	109
12.2.2	Power transformers	109
<hr/>		
<b>13</b>	<b>Glossary</b>	<b>110</b>

## Important safety instructions

Read, follow, and retain all of the following safety instructions. Heed all warnings on the unit and in the operating instructions before operating the unit.

**Type numbers:** NWC-495-10P, NWC-495-20P

1. **Cleaning** - Unplug the unit from the outlet before cleaning. Follow any instructions provided with the unit. Generally, using a dry cloth for cleaning is sufficient, but a moist fluff-free cloth or leather shammy may also be used. Do not use liquid cleaners or aerosol cleaners.
2. **Heat Sources** - Do not install the unit near any heat sources such as radiators, heaters, stoves, or other equipment (including amplifiers) that produce heat.
3. **Water** - Do not use this unit near water, for example near a bathtub, washbowl, sink, laundry basket, in a damp or wet basement, near a swimming pool, in an unprotected outdoor installation, or in any area classified as a wet location. To reduce the risk of fire or electrical shock, do not expose this unit to rain or moisture.
4. **Object and liquid entry** - Never push objects of any kind into this unit through openings as they may touch dangerous voltage points or short-out parts that could result in a fire or electrical shock. Never spill liquid of any kind on the unit. Do not place objects filled with liquids, such as vases or cups, on the unit.
5. **Controls adjustment** - Adjust only those controls specified in the operating instructions. Improper adjustment of other controls may cause damage to the unit. Use of controls or adjustments, or performance of procedures other than those specified, may result in hazardous radiation exposure.
6. **Overloading** - Do not overload outlets and extension cords. This can cause fire or electrical shock.
7. **Power cord and plug protection** - Protect the plug and power cord from foot traffic, being pinched by items placed upon or against them at electrical outlets, and its



exit from the unit. For units intended to operate with 230 VAC, 50 Hz, the input and output power cord must comply with the latest versions of *IEC Publication 227* or *IEC Publication 245*. For outdoor use the power cord must comply to *NEC400-4 (CEC Rule 4-010)* and marked with OUTDOOR, W, or W-A. .

8. Power sources - Operate the unit only from the type of power source indicated on the label. Before proceeding, be sure to disconnect the power from the cable to be installed into the unit.
  - For battery powered units, refer to the operating instructions.
  - For external power supplied units, use only the recommended or approved power supplies.
  - For limited power source units, this power source must comply with *EN60950*. Substitutions may damage the unit or cause fire or shock.
  - For 24 VAC units, voltage applied to the unit's power input should not exceed 28 VAC. User-supplied wiring must comply with local electrical codes (Class 2 power levels). Do not ground the supply at the terminals or at the unit's power supply terminals.
  - If unsure of the type of power supply to use, contact your dealer or local power company.
9. Servicing - Do not attempt to service this unit yourself. Opening or removing covers may expose you to dangerous voltage or other hazards. Refer all servicing to qualified service personnel.
10. Damage requiring service - Unplug the unit from the main AC power source and refer servicing to qualified service personnel when any damage to the equipment has occurred, such as:
  - the power supply cord or plug is damaged;
  - exposure to moisture, water, and/or inclement weather (rain, snow, etc.);
  - liquid has been spilled in or on the equipment;
  - an object has fallen into the unit;

- unit has been dropped or the unit cabinet is damaged;
  - unit exhibits a distinct change in performance;
  - unit does not operate normally when the user correctly follows the operating instructions.
11. Replacement parts - Be sure the service technician uses replacement parts specified by the manufacturer, or that have the same characteristics as the original parts. Unauthorized substitutions may cause fire, electrical shock, or other hazards.
  12. Safety check - Safety checks should be performed upon completion of service or repairs to the unit to ensure proper operating condition.
  13. Installation - Install in accordance with the manufacturer's instructions and in accordance with applicable local codes.
  14. Attachments, changes, or modifications - Only use attachments/accessories specified by the manufacturer. Any change or modification of the equipment, not expressly approved by Bosch, could void the warranty or, in the case of an authorization agreement, authority to operate the equipment.

**DANGER!** High risk:

The lightning flash and arrowhead within the triangle is a warning sign alerting you of "Dangerous Voltage" inside the product that can cause an electrical shock, bodily injury, or death.

**WARNING!** Medium risk:

The exclamation point within the triangle sign alerts the user to important instructions accompanying the unit.

**CAUTION!**

Alerts the user to the risk of damage to the unit.



**NOTE!** General sign for notes. Calls attention to important information.

**CAUTION!**

- Camera Grounding - For mounting the camera in potentially damp environments, ensure to ground the system using the ground connection of the power supply connector (see section: Connecting external power supply).
- U.S.A. models only - *Section 810* of the *National Electrical Code, ANSI/NFPA No.70*, provides information regarding proper grounding of the mount and supporting structure, grounding of the coax to a discharge unit, size of grounding conductors, location of discharge unit, connection to grounding electrodes, and requirements for the grounding electrode.
- Permanently connected equipment - Incorporate a readily accessible disconnect device in the building installation wiring.
- PoE - Never supply power via the Ethernet connection (PoE) when power is already supplied via the power connector.
- Pole power switch - Incorporate an all-pole power switch, with a contact separation of at least 3 mm in each pole, into the electrical installation of the building.
- Power lines - Do not locate the camera near overhead power lines, power circuits, or electrical lights, nor where it may contact such power lines, circuits, or lights.

**Video loss**

Video loss is inherent to digital video recording; therefore, Bosch Security Systems cannot be held liable for any damage that results from missing video information. To minimize the risk of lost digital information, Bosch Security Systems recommends multiple, redundant recording systems, and a procedure to back up all analog and digital information.

### **FCC & ICES Information**

(U.S.A. and Canadian Models Only)

This equipment has been tested and found to comply with the limits for a Class B digital device, pursuant to *part 15* of the *FCC Rules*. These limits are designed to provide reasonable protection against harmful interference in a residential installation. This equipment generates, uses, and can radiate radio frequency energy and, if not installed and used in accordance with the instructions, may cause harmful interference to radio communications. However, there is no guarantee that interference will not occur in a particular installation. If this equipment does cause harmful interference to radio or television reception, which can be determined by turning the equipment off and on, the user is encouraged to try to correct the interference by one or more of the following measures:

- reorient or relocate the receiving antenna;
- increase the separation between the equipment and receiver;
- connect the equipment into an outlet on a circuit different from that to which the receiver is connected;
- consult the dealer or an experienced radio/TV technician for help.

### **Disclaimer**

Underwriter Laboratories Inc. ("UL") has not tested the performance or reliability of the security or signaling aspects of this product. UL has only tested fire, shock and/or casualty hazards as outlined in UL's *Standard(s) for Safety for Information Technology Equipment, UL 60950-1*. UL Certification does not cover the performance or reliability of the security or signaling aspects of this product.

UL MAKES NO REPRESENTATIONS, WARRANTIES, OR CERTIFICATIONS WHATSOEVER REGARDING THE PERFORMANCE OR RELIABILITY OF ANY SECURITY OR SIGNALING RELATED FUNCTIONS OF THIS PRODUCT.

## Disposal



Your Bosch product was developed and manufactured with high-quality material and components that can be recycled and reused. This symbol means that electronic and electrical appliances, which have reached the end of their working life, must be collected and disposed of separately from household waste material. Separate collecting systems are usually in place for disused electronic and electrical products.

Please dispose of these units at an environmentally compatible recycling facility, per *European Directive 2002/96/EC*.

Bosch has a strong commitment towards the environment. This unit has been designed to respect the environment as much as possible.

For additional information, please contact the Bosch Security Systems location nearest you or visit our web site at [www.boschsecuritysystems.com](http://www.boschsecuritysystems.com)

# 1 Introduction

The Dinion IP Day/Night is a high-performance smart surveillance color camera. It incorporates 15-bit digital signal processing for outstanding picture performance under all lighting conditions. The camera operates as a network video server and transmits video and control signals over data networks such as Ethernet LANs and the Internet.

The Dinion IP Day/Night is easy to install and ready to use, and offers the best solution for demanding scene conditions. Features include:

- Day/Night camera with mechanically switching IR filter
- Three pre-programmed operation modes
- Noise elimination, true color reproduction
- Adaptive dynamic range optimization
- Enhanced video motion detection
- Video and data transmission over IP data networks
- Tri Streaming function for simultaneous encoding with three individually definable profiles
- Multicast function for simultaneous picture transmission to multiple receivers
- One analog composite video output CVBS (PAL/NTSC)
- Video encoding using international MPEG-4 standard
- Integrated Ethernet interface (10/100 Base-T)
- Remote control of all built-in functions via TCP/IP
- Password protection to prevent unauthorized connection or configuration changes
- Relay input for external sensor (such as door contacts)
- Event-driven, automatic connection (for example at switch-on and for alarms)
- Fast, convenient configuration using the integrated Web server and a browser
- Firmware update through flash memory
- Convenient upload and download of configuration data

## 1.1 Type number overview

Type number	NWC-0495-10P	NWC-0495-20P
Standard	50 Hz	60 Hz
Supply voltage	24 VAC or 12 VDC (use class 2 power supply) or PoE (IEEE 802.3af)	
CCD type	1/3"	

**Table 1.1** Dinion IP type numbers

## 1.2 Unpacking

Unpack carefully and handle the equipment with care. The packaging contains:

- Dinion<sup>XF</sup> Day/Night IP camera
- CS to C lens mount adapter
- CCD protection cap
- Spare lens connector (male)
- CD ROM
  - Manual
  - System requirements
  - Configuration Manager
  - MPEG ActiveX control
  - DirectX control
  - Microsoft Internet Explorer
  - Sun JVM
  - Player and archive player
  - Adobe Acrobat Reader
- Quick install instructions



### NOTE!

If equipment appears to have been damaged during shipment, repack it in the original packaging and notify the shipping agent or supplier.



## 1.3 System requirements

- Computer with Windows 2000/XP operating system, network access and Microsoft Internet Explorer web browser version 6.0 or later  
or
- Computer with Windows 2000/XP operating system, network access and reception software, for example VIDOS, BMVS or DIBOS 8.0  
or
- MPEG-4 compatible hardware decoder from Bosch Security Systems (such as VIP XD) as a receiver and a connected video monitor

The minimum PC requirements are:

- Operating platform: A PC running Windows 2000 or Windows XP with IE 6.0
- Processor: 1.8 GHz Pentium IV
- RAM memory: 256 MB
- Video system: 128 MB video memory, 1024 x 768 display with 24-bit color
- Network interface: 100-BaseT
- DirectX: 9.0b



**NOTE!** Make sure the graphics card is set to 16-bit or 32-bit color depth and that Sun JVM is installed on your PC. To play back live video images, an appropriate MPEG ActiveX must be installed on the computer. If necessary, install the required software and controls from the product CD provided. If you need further assistance, contact your PC system administrator.

## 1.4 Overview of functions

The camera incorporates a network video server. Its primary function is to encode video and control data for transmission over an IP network. With its MPEG-4 encoding it is ideally suited for IP communication and for remote access to digital video recorders and multiplexers. The use of existing networks means that integration with CCTV systems or local networks can be

achieved quickly and easily. Video images from a single camera can be simultaneously received on several receivers.

#### **1.4.1 Wide dynamic range**

A unique combination of 15-bit digital video processing that enhances sensitivity and XF-Dynamic which extends the dynamic range, provides a sharper, more detailed image with outstanding accuracy in color reproduction. The 15-bit digital signal is automatically processed to optimally capture the detail in both the high and low light areas of the scene simultaneously, maximizing the information visible in the picture.

#### **1.4.2 Day/Night function**

The Day/Night function provides enhanced night viewing by increasing the IR sensitivity. The motorized IR filter can be removed in low-light or IR illuminated applications. The IR filter switches from color to monochrome automatically by sensing the illumination level. In auto switching mode the camera prioritizes motion (the camera gives sharp images without motion blur) or color (the camera gives color pictures as long as the light level permits).

#### **1.4.3 Power-over-Ethernet**

Power for the camera can be supplied via a Power-over-Ethernet (IEEE 802.3af) compliant network cable connection. With this configuration, only a single cable connection is required to view, power and control the camera.

#### **1.4.4 Receiver**

MPEG-4 compatible hardware decoders (for example VIP XD) can be used as a receiver. Computers with decoding software such as VIDOS or computers with the Microsoft Internet Explorer web browser installed can also be used as receivers.

#### **1.4.5 Video encoding**

The camera uses the MPEG-4 compression standard. Thanks to efficient encoding, the data rate remains low even with high image quality and can also be adapted to local conditions within wide limits.

### **1.4.6 Tri Streaming**

Tri Streaming allows the incoming data stream to be encoded simultaneously according to three different, individually customized profiles. This creates two MPEG4 streams per camera that can serve different purposes, for example, one for local recording and one optimized for transmission over the LAN, and an additional JPEG stream for use with a PDA.

### **1.4.7 Recording**

The camera can be used with an iSCSI server connected via the network to store long-term recordings.

### **1.4.8 Multicast**

In suitably configured networks, the multicast function enables simultaneous, real time transmission to multiple receivers. The prerequisite for this is that the UDP and IGMP V2 protocols are implemented on the network.

### **1.4.9 Encryption**

The data transmissions and the authentication channel can be encrypted to prevent unauthorized access. Web browser connections can be protected using HTTPS.

### **1.4.10 Configuration**

The camera can be configured using a browser on the local network (Intranet) or from the Internet. Similarly, firmware updates and rapid loading of device configurations are also possible. Configuration settings can be stored as files on a computer and copied from one camera to another.

### **1.4.11 Tampering recognition and motion detectors**

The camera offers a wide range of configuration options for alarm signaling in the event of tampering with the camera. An algorithm for detecting movement in the video image is also part of the scope of delivery and can optionally be extended to include special video analysis algorithms.

### 1.4.12 **Snapshots**

Individual video frames (snapshots) can be called up as JPEG images, stored on the hard drive or displayed in a separate browser window.

### 1.4.13 **Backup**

The browser application **Livepage** has an icon for saving the video images provided by the unit as a file on your computer's hard drive. Clicking this icon stores the video sequences and they can be replayed with the Player from Bosch Security Systems included with the package.

### 1.4.14 **Intelligent Video Motion Detection**

The intelligent video motion detection (iVMD) system of the camera uses advanced analysis algorithms with comprehensive functions for the detection of motion.

## 2 Connections



### CAUTION!

Installation should only be performed by qualified service personnel in accordance with the National Electrical Code or applicable local codes.



### CAUTION!

The camera module is a sensitive device and must be handled carefully. Do not drop when disassembling the unit.

### 2.1 Power



### CAUTION!

Ensure that your power supply matches the rated voltage of your camera before installing.



### CAUTION!

Never supply power via the power connector when power is supplied via the Ethernet connection (PoE).

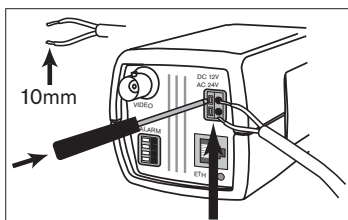

- use a class 2 power supply
- 24 VAC or 12 VDC
- push in the tabs to open the quick-connectors (these connections are not polarity sensitive).
- use AWG16 to 22 stranded wire or AWG16 to 26 solid wire; cut back 10mm (0.4") of insulation.

**Fig. 2.1** Power connection

## 2.2 Network (and power)



### CAUTION!

Never supply power via the Ethernet connection (PoE) when power is supplied via the power connector.

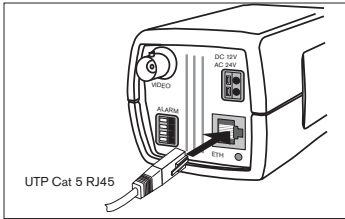

- connect the camera to a 10/100 Base-T network.
- use a shielded UTP Category 5 cable with RJ45 connectors.
- Power can be supplied to the camera via the Ethernet cable compliant with the Power-over-Ethernet (IEEE 802.3af) standard.

**Fig. 2.2** Network and power connection

The multicolored LED under the Ethernet connection indicates Power (red), IP connection (green) and IP traffic (green flashing). It can be disabled in the *Settings/Camera Settings/Installer options* menu.

## 2.3 Video service monitor

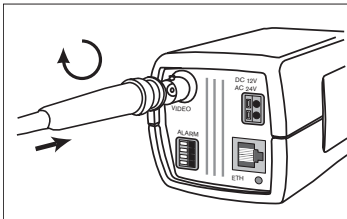

- connect a service monitor to the composite video BNC connector to aid installation.
- a monitor connected close to the camera via this connection can also be used in parallel with remote PC viewing.

**Fig. 2.3** Service monitor connection

## 2.4 Alarm connector

Pin	Alarm socket
1	Ground
2	Alarm in
3	Relay out contact 1
4	Relay out contact 2

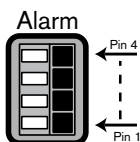

- Max. wire diameter AWG 22-28 for both stranded and solid.
- Default relay position n.o. (normally open), no alarm.
- Alarm output relay switching capability: Max voltage 30VAC or +40VDC. Max 0.5 A continuous, 10VA.
- Alarm in: TTL logic, +5V nominal, +40VDC max, DC coupled with 22kOhm pull-up to +3.3V.
- Alarm in: configurable as active low or active high.
- Max. 42V allowed between camera ground and each of the relay pins.

**Fig. 2.4** Network and power connection

## 3 Mounting

### 3.1 Lens mounting

The camera accepts CS-mount lenses with a lens protrusion of up to 5mm. C-mount lenses can be mounted using the lens adapter ring. DC-iris lenses are recommended for the best picture performance. The camera automatically detects the type of lens used and optimizes performance accordingly. A spare male lens connector is provided.



#### CAUTION!

To avoid damaging the CCD sensor when using a C-mount lens, make sure the supplied lens adapter ring is mounted onto the camera before mounting the lens.

Lenses weighing more than 0.5 kg (1.1lbs) must be separately supported.

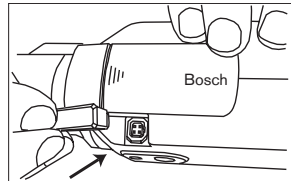
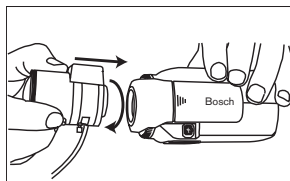

**Fig. 3.1** Mounting a lens

Pin	Video iris lens	DC iris lens
1	Supply (11.5V $\pm$ 0.5, 50mA max.)	Damp -
2	Not used	Damp +
3	Video signal 1Vpp 1kOhm	Drive +
4	Ground	Drive -

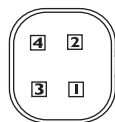

#### NOTE!

If a short circuit is detected on the lens connector, the on-screen display (OSD) failure message LENS SHORT CIRCUIT is shown. The lens circuit is automatically disabled to avoid internal damage. Remove the lens connector and check the pin connections.



## 3.2 Mounting the camera

The camera can be mounted from the top or bottom. The bottom mounting is isolated from ground. With outdoor scenes, a DC-iris lens is recommended.

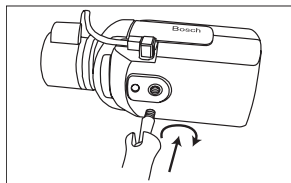

### CAUTION!

Do not point the camera/lens into direct sunlight.  
Do not obstruct the free flow of air around the camera.



### NOTE!

The camera becomes quite warm when operating; this is normal.  
However, you should take this into account when touching the camera.

## 4 Quick set-up

The Dinion IP Day/Night camera normally provides an optimal picture without the need for further adjustments. Configuration of the camera is carried out remotely via the network using a web browser. However, the camera also has an Installer menu in which basic installation settings (lens wizard, IP address) can be accessed. To view this menu connect a monitor to the composite video output of the camera.

### 4.1 Back focus adjustment

To optimize picture sharpness in both bright and low-level lighting, adjust the back focus. Use the camera's unique Lens Wizard. This ensures that the object of interest always remains in focus even when focusing at the maximum lens opening.

- When back focusing vari-focus lenses, adjust to obtain a sharp picture in both wide-angle and tele positions for both far and near focus.
- When back focusing zoom lenses, ensure the object of interest remains in focus throughout the entire zoom range of the lens.

To adjust back focus:

1. Open the slide door at the side of the camera
2. Unlock the back focus locking button.

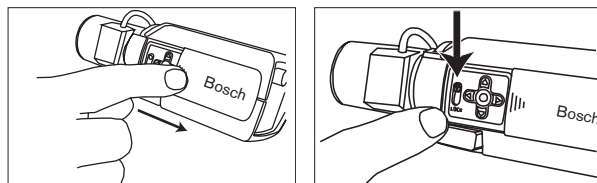

3. Turn the back focus adjustment as required.

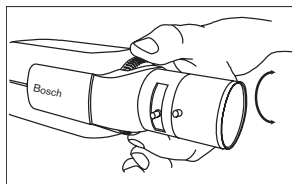

4. Lock the back focus locking button.

## 4.2 Accessing and navigating quick set-up menu

Five keys, located behind the side panel, are used for navigating through the quick set-up menu. To access the set-up menus, press the menu/select key (center). The main menu appears on the monitor.

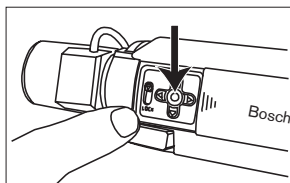
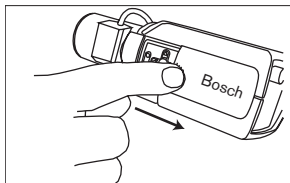

### 4.2.1 How to use the navigation keys

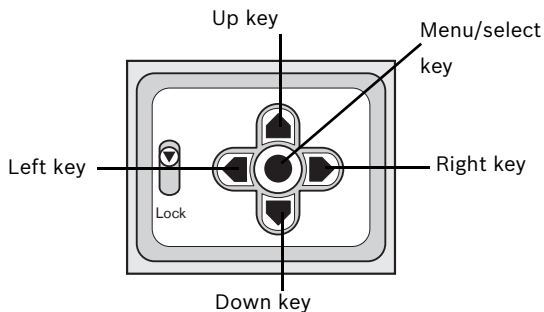

- Press the menu/select key to access the menus or to move to the next or previous menu.
- Press the menu/select key for approximately 1.5 seconds to open the Installer menu.

- Use the up or down keys to scroll up or down through a menu.
- Use the left or right keys to move through options or to set parameters.
- When in a menu, quickly pressing the menu/select key twice restores the selected item to its factory default.
- To close all menus at once from any menu, select the Exit item and hold down the menu/select key until the menu display disappears.

## 4.2.2 Install menu

Function	Selection	Description
Lens Wizard	Select submenu	Select to optimize camera lens combination
Network	Select submenu	Select to set the network IP address for the camera (default address is 192.168.0.1)
Exit		Exit the menu

### Install lens wizard submenu

Function	Selection	Description
Lens Type	AUTO, MANUAL, DCIRIS, VIDEO	In AUTO mode the camera auto detects the type of lens used or force the camera into a mode.
Detected		If the LENS TYPE detection is in AUTO, the detected lens type is shown.
Set Back Focus Now		Select to force lens to its maximum opening. After focusing the lens the object of interest remains in focus in bright and low light conditions.
Set LVL		(Video iris lenses only). The level detector indicator must be set to the center by adjusting the level potentiometer on the lens, to obtain the best picture performance.
Exit		Return to the INSTALL menu

## 4.3 Adjustment procedure DC-iris Lens

1. Unlock the back focus locking button.
2. Access the Lens Wizard menu.
3. Set Back Focus Now is highlighted in the menu.

4. Turn the back focus adjustment as required.
5. Lock the back focus locking button.
6. Exit the menu.

## 4.4 Adjustment procedure Manual-iris Lens

1. Unlock the back focus locking button.
2. Adjust the lens to the maximum lens opening.
3. Turn the back focus adjustment as required.
4. Lock the back focus locking button.

## 4.5 Adjustment procedure Video-iris Lens

1. Unlock the back focus locking button.
2. Access the `Lens Wizard` menu.
3. `Set Back Focus Now` is highlighted in the menu.
4. Turn the back focus adjustment as required.
5. Lock the back focus locking button.
6. Select `Set LVL` in the menu; the `Level` bar appears.
7. Point the camera at the scene it will be mostly viewing.
8. Adjust the level potentiometer located on the lens until the `Level` bar is in the central position.
9. Exit the menu.

The best performance with video iris lenses is obtained when the peak/average potentiometer of the lens matches the peak/average balance configuration setting.

## 4.6 Install IP address submenu

To operate the camera in your network, a network-valid IP address must be assigned. The factory default IP address is 192.168.0.1

Function	Selection	Description
IP Address		Enter an IP address for the camera. Use LEFT/RIGHT to change position in the address, use UP/DOWN to select the digit. Use SELECT to exit the address edit screen.

Subnet Mask		Enter the Subnet mask (default 255.255.255.0)
Gateway		Enter a Gateway address.
Exit		Return to the Install menu

The new IP address, subnet mask and gateway address are set after you leave the menu. The camera reboots internally and the new values are set after a few seconds.

## 4.7 Defaults

To restore all parameters (including IP address) to the factory defaults, press and hold the Up navigation key for at least 10 seconds and then confirm. Allow a few seconds for the camera to optimize the picture after a mode reset.

Restoring the factory defaults may result in the loss of the IP connection. If this occurs, change the IP address of your browser to the factory default value. Only restore the factory defaults when it is absolutely necessary.

## 5 Network connection

A computer with Microsoft Internet Explorer can be used to receive live images from the camera, control cameras and replay sequences stored on the local hard drive. The camera is configured over the network using the browser or via the Configuration Manager (supplied with the product). The configuration options using the menu system of the camera itself are limited to setting up the lens and network.



### NOTE!

The camera can also be connected to DIBOS 8.0, VIDOS and BVMS video management systems as well as third party video management systems.

### 5.1 System requirements

- Microsoft Internet Explorer version 6.0 or higher
- Monitor resolution 1024 × 768 pixels, 16 or 32 bit color depth
- Intranet or Internet network access

To play back live video images, an appropriate MPEG ActiveX must be installed on the computer. If necessary, the required software and controls can be installed from the product CD provided.

- a. Insert the CD into the CD-ROM drive of the computer. If the CD does not start automatically, open the root directory of the CD in Windows Explorer and double click MPEGAx.exe.
- b. Follow the on-screen instructions.

### 5.2 Establishing the connection

The camera must be assigned a valid IP address to operate on your network. The default address pre-set at the factory is 192.168.0.1

1. Start the Web browser.
2. Enter the IP address of the camera as the URL.

### Password protection in camera

If the camera is password-protected, a message to enter the password appears.

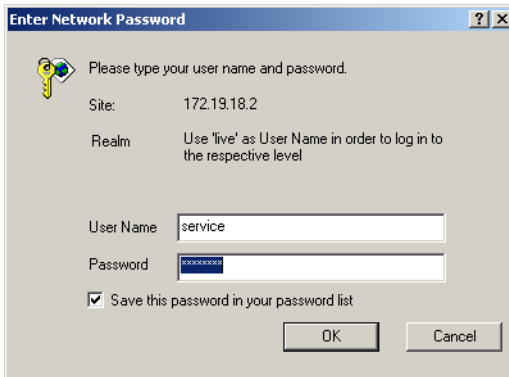

#### NOTE!

A camera offers you the option of limiting access across various authorization levels.

1. Enter the user name and the associated password in the appropriate fields.
2. Click **OK**. If the password is correct, the desired page is displayed.

After a short time when the connection is established, the **Live-page** with the video image appears. In the application title bar the **Livepage** selection is used to operate the camera; the **Settings** selection is used to configure the camera and the application interface.



**NOTE!** If the connection is not established, the maximum number of possible connections may already have been reached. Depending on the device and network configuration, up to 20 web browsers, or 50 VIDOS or BVMS connections are supported.



## **5.3 Secured network**

If a Radius server is used for network access control (802.1x authentication), the camera must be configured first. To configure the camera for a Radius network, connect it directly to a PC via a crossed network cable and configure the two parameters, identity and password. Only after these have been configured can you communicate with the camera via the network.

## 6 Operation via the browser

### 6.1 Livepage

After the connection is established, the **Livepage** is initially displayed. It shows the live video image on the right of the browser window. Depending on the configuration, various text overlays may be visible on the live video image. Other information may also be shown next to the live video image on the **Livepage**. The display depends on the settings on the **Livepage configuration** page.

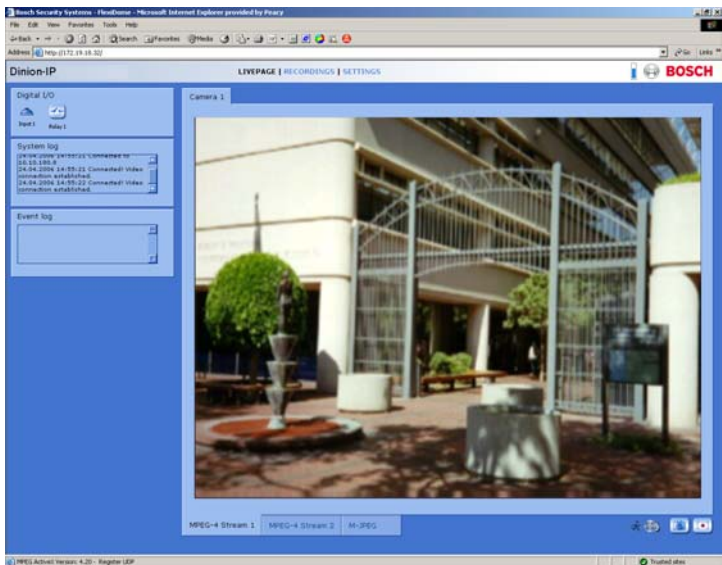

#### 6.1.1 Processor load

When accessing the camera with a browser, the processor load is displayed in the upper right of the window next to the Bosch logo.



Move the mouse cursor over the icons to display numerical values. This information can help with problem solving or when fine tuning the device.

## 6.1.2 Image selection

You can view the image on a full screen.

- Click one of the MPEG-4 Stream 1, MPEG-4 Stream 2 or MJPEG tabs below the video image to switch between the different displays for the camera image.

## 6.1.3 Digital I/O

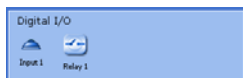

Depending on the configuration of the unit, the alarm input and the relay output are displayed next to the camera image. The alarm symbol is for information and indicates the input status of the alarm input: Active 1 = Symbol is green, Active 0 = Symbol not lit. The relay on the camera allows you to operate a device (for example a light or a door opener).

- To operate, click the relay symbol next to the video image. The symbol is red when the relay is activated.

## 6.1.4 System log / Event log

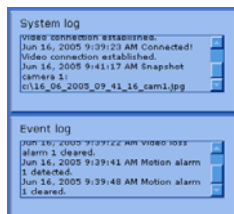

The System log field contains information about the operating status of the camera and the connection. These messages can be saved automatically in a file. Events such as the triggering or end of alarms are shown in the Event log field. These messages can be saved automatically in a file.

## 6.1.5 Saving snapshots

Individual images from the video sequence that is currently being shown on the **Livepage** can be saved in JPEG format on the computer's hard drive.



1. Click the camera icon  to save single images.
2. The image is saved at a resolution of 704 × 576/480 pixels (4CIF). The storage location depends on the configuration of the camera.

### 6.1.6 Recording video sequences

Sections of the video sequence that is currently being shown on the **Livepage** can be saved on the computer's hard drive. The sequences are recorded at the resolution specified in the encoder configuration. The storage location depends on the configuration of the camera.



1. Click the recording icon  to record video sequences.
  - Saving begins immediately. The red dot on the icon flashes to indicate that a recording is in progress.
2. Click the symbol for recording video sequences again. Saving is terminated.

#### Installing Player

You can play back saved video sequences using the Player from Bosch Security Systems, which can be found on the software CD supplied.



#### NOTE!

A corresponding MPEG ActiveX (located on the CD provided with the product) must be installed on the computer in order to play back saved video sequences using the Player.

1. Insert the CD into the CD-ROM drive of the computer. If the CD does not start automatically, open the CD in the Windows Explorer and double click the index.html file to start the installation.
2. Select a language from the list box at the top.
3. Click **Tools** in the menu.
4. Click **Archive Player**; the installation starts.
5. Follow the instructions in the installation program. The Archive Player is installed together with the Player.

6. After a successful installation, two new icons for the Player and the Archive Player appear on the desktop.
7. Double click the Player icon to start the Player.

### 6.1.7 Running recording program

The hard drive icon below the camera images on the **Livepage** changes during an automatic recording.

The icon lights up and displays a moving graphic  to indicate a running recording. If no recording is taking place, a gray icon is displayed.

## 6.2 Recordings page

You can access the **Recordings** page for playing back recorded video sequences from the **Livepage** as well as from the **Settings** menu. The **Recordings** link is only visible if a storage medium has been selected (see “Recording” on page 61).

- Click **Recordings** in the navigation bar in the upper section of the window. The playback page appears.

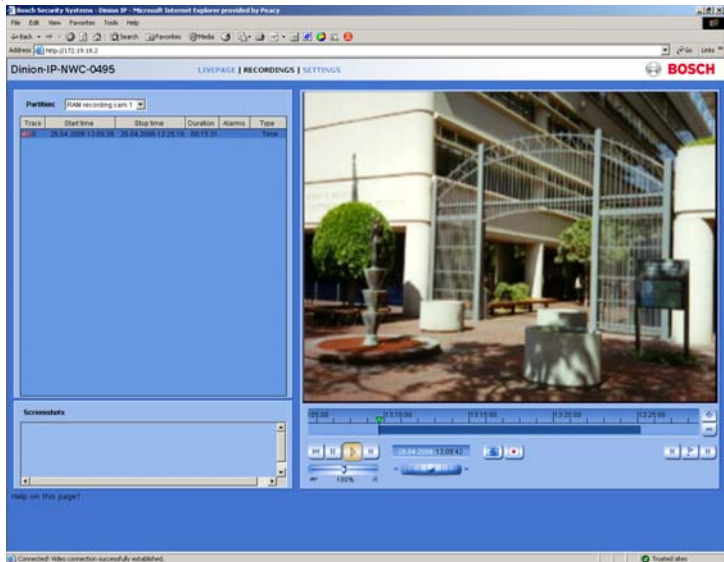

## 6.2.1 Selecting recordings

In the left section of the page, first select the partition whose recordings you want to view.

All sequences that are saved in the partition are displayed in the list. A running number (track) is assigned to each sequence. Start time and stop time, recording duration, number of alarms, and recording type are displayed.

1. Click a partition name from the list to display the recordings for this partition.
2. Click a list entry. The playback for the selected sequence starts immediately in the video window.

## 6.2.2 Controlling playback

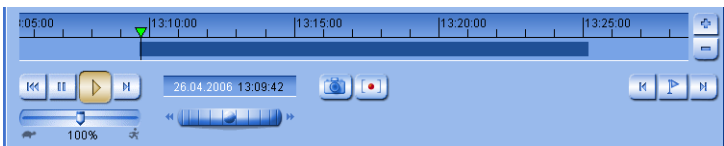

You will see a time bar below the video image for quick orientation. If a particular sequence has been selected for playback by

means of click, the selected sequence is highlighted. The associated time interval is displayed in the bar in blue. A green arrow above the bar indicates the position of the image currently being played back within the sequence.

The time bar offers various options for navigation in and between sequences.

- You can change the time interval displayed by moving the blue area to the left or right while holding down the mouse button.
- You can change the time interval displayed by clicking the plus or minus icons. The display can span a range from two months to a few seconds.
- You can select a different sequence for playback by clicking on the corresponding blue marking.
- If required, drag the green arrow to the point in time at which the playback should begin. Alternatively you can double-click directly in the blue time interval or in the time scale to jump to the position selected in this manner.

The date and time display below the bar provides orientation to the second.

You can control playback by means of the buttons below the video image. The buttons have the following functions:



Start playback



Pause playback



Jump to start of active video sequence or to previous sequence in the list



Jump to end of active video sequence or to next sequence in the list

You can use the slide control to control playback speed and fast forward/rewind: positioning in the middle indicates playback at

recording speed, left indicates rewind, and right fast forward. The fast forward or rewind speed changes, depending on how far you move the slide control toward the runner icons.



You can continuously select playback speed by means of the speed regulator:



Red bars within the blue-gray sequence fields indicate the points in time where alarms were triggered. Drag the green arrow to navigate to these points quickly.

In addition, you can set markers in the sequences, so-called bookmarks, and jump directly to these. These bookmarks are indicated as small yellow arrows above the time interval. Use the bookmarks as follows:



Jump to the previous bookmark



Set bookmark



Jump to the following bookmark

- Right-click a bookmark to delete it.

**NOTE!**

Bookmarks are only valid while you are in the Recordings page; they are not saved with the sequences. As soon as you leave the page all bookmarks are deleted.



# 7 Configuration via the browser

## 7.1 Settings

When a connection is established, the **Livepage** is initially displayed. Click **Settings** in the application title bar to configure the camera and the application interface. A new page containing the configuration menu is opened.

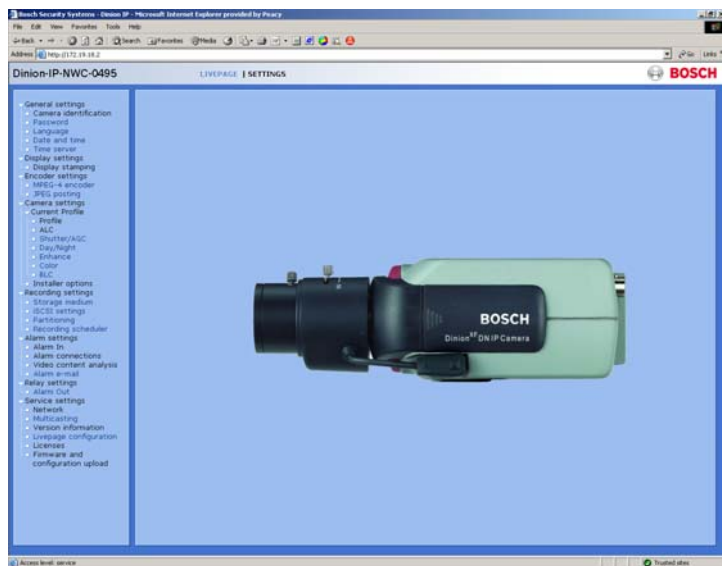

All settings are stored in the camera memory, and they are preserved even if the power is interrupted.

### Configuration menu tree

The configuration menu tree allows all parameters of the camera to be configured. The configuration menu is recommended for expert users or system administrators. All unit parameters can be accessed in this mode. Changes that influence the fundamental functioning of the unit (for example firmware updates) can only be made using the configuration menu.

- General settings
  - Camera identification
  - Password
  - Language
  - Date and time
  - Time server
- Display settings
  - Display stamping
- Encoder settings
  - MPEG-4 encoder
  - JPEG posting
- Camera settings
  - ALC
  - Shutter/AGC
  - Day/Night
  - Enhance
  - Color
  - BLC
  - Installer options
- Recording settings
  - Storage medium
  - iSCSI settings
  - Partitioning
  - Recording profiles
  - Recording scheduler
- Alarm settings
  - Alarm In
  - Alarm connections
  - Video content analysis
  - Alarm e-mail
- Relay settings
  - Alarm Out
- Service settings
  - Network
  - Multicasting
  - Version information
  - Livepage configuration
  - Licenses
  - Firmware and configuration upload

You can view the current settings by opening one of the configuration pages.

1. Click one of the menu options on the left of the window.  
The associated sub-menu is opened.
2. Click one of the links in the sub-menu. The corresponding page is opened.

The settings are changed by entering new values or by selecting a pre-defined value in a list field.

### Saving changes

After making changes in a window, click the **Set** button to send the new settings to the unit and save them there.



#### NOTE!

Save the changes made in each window by clicking **Set**. Clicking the **Set** button saves only the settings in the current window. Changes in any other fields are ignored.

Click the **Settings** link at the top of the window to close the window without saving the changes made.

## 7.2 General Settings

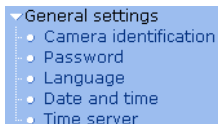

Various basic data for the camera can be set or selected here.

### 7.2.1 Camera identification

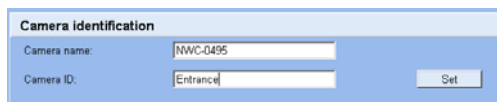

#### Camera name

The camera can be assigned a name to assist in identifying it. The name simplifies the management of multiple devices in more extensive systems, for example using the VIDOS or BVMS software.



**NOTE!** The camera name is used for remote identification of a unit, in the event of an alarm for example. Enter a name that makes it as easy as possible to identify the location unambiguously.

#### Camera ID

Each camera should be assigned a unique identifier that can be entered here as an additional means of identification.

## 7.2.2 Password protection

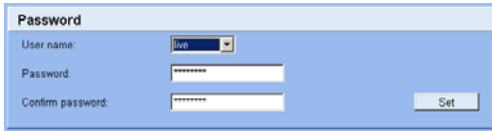

A camera is generally protected by a password to prevent unauthorized access to the unit. You can use various authorization levels (User name:;) to limit access.



**NOTE!** Proper password protection is only guaranteed if all higher authorization levels are also protected with a password. For example, if a live password is assigned, a service and a user password should also be set. When assigning passwords, you should always start from the highest authorization level.

### User name

The camera recognizes three user names: service, user and live, which correspond to different authorization levels.

- The user name service represents the highest authorization level. After entering the corresponding password, you can use it to access all the functions of the camera and change all configuration settings.
- The user name user represents the middle authorization level. You can use it to operate the unit and also to control cameras, but you cannot change the configuration.
- The user name live represents the lowest authorization level. It can only be used to view the live video image and switch between the different live image displays.

### Password

You can define and change a separate password for each user name if you are logged on as Service or if the unit is not protected by a password. Enter the password for the selected user name here.

### Confirm password

Re-enter the new password to rule out typing mistakes.



**NOTE!** The new password is then saved by clicking the **Set** button. You should therefore click the **Set** button immediately after entering and confirming the password, even if you also want to assign a password to another user name.

### 7.2.3 Language selection

Language  
Website language: English Set

#### Website language

Select the language for the user interface here.

### 7.2.4 Date and time

Date and Time  
Date format: Europe  
Unit date: Thursday 16 06 2005  
Unit time: 09 47 30 Synchr. PC Set

#### Date format

Choose the desired date format here

(Europe: DD.MM.YYYY; USA: MM.DD.YYYY; Japan: YYYY/MM/DD).

#### Unit date and time

If there are a number of devices operating in your system or network, it is important to synchronize their internal clocks. For example, it is only possible to carry out correct identification and evaluation of recordings occurring at the same time if all devices are operating on the same time.

1. Enter the current date. Since the unit time is controlled by the internal clock, it is not necessary to enter the day of the week. This is added automatically.
2. Enter the current time or click **Synchr. PC** to apply the system time from your computer to the camera.

## 7.2.5 Time server

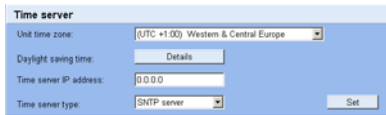

The camera supports several network time server protocols and can synchronize its internal clocks with various types of time servers. The device calls up the time signal automatically once every minute.

### Unit time zone

Select the time zone in which the system is located.

### Daylight saving time

The internal clock can automatically switch between normal and daylight saving time (DST). The camera already contains the tables for DST switch overs up to the year 2015. These can be used or modified, if required. If you do not create a table, there is no automatic switching. When editing the table, note that values generally occur in linked pairs (DST start and end dates).

First check the time zone setting. If it is not correct select the appropriate time zone for the system:

1. Click **Set**.
2. Click **Details**. A new window opens showing an empty table.
3. Click **Generate** to fill the table with the preset values from the camera.
4. Select the region or the city which is closest to the system's location from the list box below the table.
5. Click one of the entries in the table to make changes. The entry is highlighted.
6. Clicking **Delete** removes the entry from the table.
7. Choose other values from the list boxes under the table, to change the selected entry. Changes are immediate.
8. If there are empty lines at the bottom of the table, for example after deletions, you can add new data by marking the row and selecting values from the list boxes.

- When you are finished, click **OK** to save and activate the table.

### Time server IP address

Enter the IP address of a time server.

### Time server type

Choose the protocol used by the selected time server.

It is recommended that you choose the **SNTP server** protocol. This protocol provides higher accuracy and is required for certain applications, as well as for future additions.

Choose **Time server**, if the server uses RFC 868 as protocol.

## 7.3 Display Settings

### 7.3.1 Display stamping

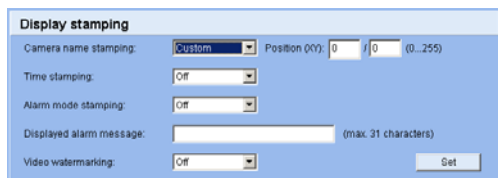

The screenshot shows a configuration window titled "Display stamping". It contains the following elements:

- Camera name stamping:** A dropdown menu set to "Custom". To its right are two input boxes for "Position (00)", both containing "0", and a label "(0..255)".
- Time stamping:** A dropdown menu set to "Off".
- Alarm mode stamping:** A dropdown menu set to "Off".
- Displayed alarm message:** A text input field with a label "(max. 31 characters)".
- Video watermarking:** A dropdown menu set to "Off".
- A "Set" button is located at the bottom right of the window.

Various overlays or stamps in the video image provide important supplementary information. These overlays can be enabled individually and arranged on the image in a clear manner.

#### Camera name stamping

This field sets the position of the camera name overlay. It can be displayed at the Top, at the Bottom or at a position of your choice using the Custom option. Or it can be set to Off if no overlay of this information is to be shown.

#### Time stamping

This field sets the position of the time and date overlay. It can be displayed at the Top, at the Bottom or at a position of your choice, which you have pre-defined using HyperTerminal, using the Custom option. Or it can be set to Off if no overlay of this information is to be shown.

### Alarm mode stamping

Choose On if a text message should be overlaid in the event of an alarm. It can be displayed at a position of your choice using the Custom option. Or it can be set to Off if no overlay of this information is to be shown.

1. Select the desired position from the lists.
  - If you have selected the Custom option, additional fields are displayed to specify the exact position (Position (XY):).
2. In the Position (XY): fields enter the values for the desired position.

### Displayed alarm message

Enter the message to be displayed for an alarm. It can contain up to 31 characters.

### Video watermarking

Choose On if the video images transmitted are to be watermarked. After activation, all images are marked with a small green rectangle. A red rectangle indicates that the sequence (live or saved) has been manipulated.

## 7.4 Encoder Settings

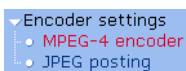

For encoding the video signal, you can select two profiles and change the presets for the profiles.

### 7.4.1 Selecting an encoder profile

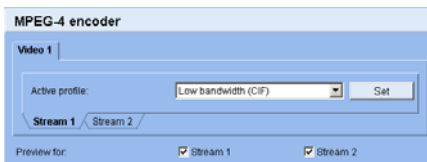

You can adapt the MPEG-4 data transmission to the operating environment (for example network structure, bandwidth, data



structures). To do this, the camera simultaneously generates two data streams (Dual Streaming), for which you can select different compression settings, for example one setting for transmissions to the Internet and one for LAN connections. Pre-programmed profiles are available, which each give priority to different perspectives.

- Profile 1: Low bandwidth (CIF)  
High quality for low bandwidth connections, resolution 352 × 288/240 pixels
- Profile 2: Low delay (2/3 D1)  
High quality with low delay, resolution 464 × 576/480 pixels
- Profile 3: High resolution (4CIF/D1)  
High resolution for high bandwidth connections, resolution 704 × 576/480 pixels
- Profile 4: DSL  
For DSL connections at 500 kBit/s, resolution 352 × 288/240 pixels
- Profile 5: ISDN (2B)  
For ISDN connections via two B channels, resolution 352 × 288/240 pixels
- Profile 6: ISDN (1B)  
For ISDN connections via one B channel, resolution 352 × 288/240 pixels
- Profile 7: Modem  
For analog modem connections at 20 kBit/s, resolution 352 × 288/240 pixels
- Profile 8: GSM  
For GSM connections at 9,600 baud, resolution 176 × 144/120 pixels

### **Active profile**

Here you can select the desired profile for each of the two streams. You will see a preview for each data stream in the right section of the window. The preview of the data stream currently selected is marked by a frame. Various additional items of infor-

mation regarding data transmission are displayed and continually updated above the previews.

1. Click a tab to select the associated stream.
2. Select the desired setting from the list.



**NOTE!**

Stream 2 is always transmitted for alarm connections and automatic connections. Take this into account when assigning the profile.

**Preview for**

Select which video data stream should be displayed in the previews. You can deactivate the display of the video images if the performance of the computer is affected too strongly by the decoding of the data streams.

- Check the box for the required data stream.

## 7.4.2 Changing profiles

You can change individual parameter values within a profile and the name. You can switch between profiles by clicking the associated tabs.



**NOTE!** The profiles are rather complex. They include a number of parameters that interact with one another. Therefore it is generally best to use the default profiles. The profiles should only be changed if you are completely familiar with all the configuration options.



**NOTE!** The parameters as a group constitute a profile and are dependent on one another. If you enter a setting outside the allowed range for a parameter, the nearest valid value is substituted when the settings are saved.

### **Profile name**

You can enter a new name for the profile here. The name is then displayed in the list of available profiles in the Active encoder profile: field.

### **Target data rate**

To optimize utilization of the bandwidth in your network, you can limit the data rate for the camera. The target data rate should be set according to the desired picture quality for typical scenes with no excessive motion.

For complex images or frequent changes of image content due to frequent movements, this limit can temporarily be exceeded as far as the value you enter in the Max. data rate: field.

### **Encoding interval**

The figure selected here determines the interval at which images are encoded and transmitted. For example, entering 4 means that only every fourth image is encoded, the following three images are skipped – this can be particularly advantageous with low bandwidths. The image rate in IPS (Images Per Second) is displayed next to the text block.

### **Video resolution**

Here, you can select the desired resolution for the MPEG-4 video image. The following resolutions are available:

- QCIF 176 × 144/120 pixels
- CIF 352 × 288/240 pixels
- 1/2 D1 352 × 576/480 pixels
- 2CIF 704 × 288/240 pixels
- 4CIF/D1 704 × 576/480 pixels
- 2/3 D1 464 × 576/480 pixels

## Default

Click **Default** to return the profile to the factory default values.

## Details

Click **Details** to display further settings for image quality and communication parameters. These settings require familiarity with MPEG and video encoding standards. Incorrect settings could result in useless video images.



Details	
Max. data rate:	1500 1-Bit/s
P-frame quality:	Auto High Low
I-frame quality:	Auto High Low
I-frame distance:	10

### Max. data rate

This maximum data rate is not exceeded under any circumstances. Depending on the video quality settings for the I- and P-frames this can result in the skipping of individual images. The value entered here should be at least 10% higher than the value entered in the Target data rate field.

### P-frame video quality

This setting allows you to adjust the image quality of the P-frames depending on the movement within the image. The Auto option automatically adjusts to the optimum relationship between movement and image definition (focus). Selecting Manual allows you to set a value between 4 and 31 on a slide bar. The value 4 represents the best quality with, if necessary, a lower frame refresh rate depending on the settings for the maximum data rate. A value of 31 results in a very high refresh rate and lower image quality.

### I-frame video quality

This setting allows you to adjust the image quality of the I-frames. The Auto option automatically adjusts the quality to the settings for the P-frame video quality. Selecting Manual allows you to set a value between 4 and 31 on a slide bar. The value 4 represents the best quality with, if necessary, a lower frame refresh rate depending on the settings for the maximum data

rate. A value of 31 results in a very high refresh rate and lower image quality.

### I-frame distance

This parameter determines the number of inter-coded frames between two I-frames.

## 7.4.3 JPEG posting

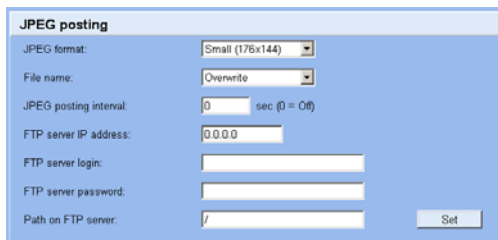

You can save individual JPEG images on an FTP server at certain intervals. You can then retrieve these images at a later date to reconstruct alarm events if required.

### JPEG format

Select the resolution you wish the JPEG images to have:

- Small 176 × 144/120 pixels (QCIF)
- Medium 352 × 288/240 pixels (CIF)
- Large 704 × 576/480 pixels (4CIF)

### File name

You can select how file names will be created for the individual images which are transmitted.

- Overwrite: The same file name is always used and any existing file will be overwritten with the current file.
- Increment: A number from 000 to 255 is added to the file name and automatically increased by 1. When it reaches 255 it starts again from 000.
- Date/time suffix: The date and time are automatically added to the file name. When setting this parameter, please ensure that the date and time of the unit are always correctly set. Example: the file snap021606\_124530.jpg

was stored on February 16, 2006 at 12.45 p.m. and 30 seconds.

**JPEG posting interval**

Enter the interval in seconds at which the images will be sent to an FTP server. Enter zero if you do not want any images to be sent.

**FTP server IP address**

Enter the IP address of the FTP server on which you wish to save the JPEG images.

**FTP server login**

Enter your login name for the FTP server.

**FTP server password**

Enter the password that gives you access to the FTP server.

**Path on FTP server**

Enter the exact path on which you wish to post the images on the FTP server.

**Post JPEG from camera**

Check the box to activate one or more camera inputs for the JPEG image. An enabled camera input is indicated by a check mark.

**NOTE!**

The numbering follows the labeling of the video inputs on the actual unit.

## 7.5 Camera settings

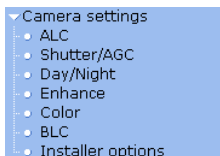

### NOTE!

If the camera is in monochrome mode, all color related menu items are disabled and cannot be accessed.

### 7.5.1 ALC

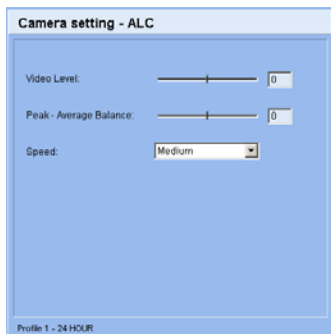

#### Video level

Adjust the video output level (-15 to 0 to +15).

#### Peak Average

Adjust the balance between peak and average video control (-15 to 0 to +15).

At -15 the camera controls the average video level, at +15 the camera controls the peak video level.

#### ALC Speed

Adjust the speed of the video level control loop (Slow, Medium or Fast).

## 7.5.2 Shutter/AGC



### Shutter

- **AES** (auto-shutter) - the camera automatically sets the optimum shutter speed for manual iris lenses. The camera tries to maintain the selected shutter speed (1/60 [1/50], 1/100, 1/120, 1/250, 1/500, 1/1000, 1/2000, 1/5000, 1/10K) as long as the light level of the scene permits.
- **FL** - flickerless mode avoids interference from light sources (recommended for use with video iris or DC iris lenses only).
- **FIXED** - allows a user defined shutter speed (1/60 [1/50], 1/100, 1/120, 1/250, 1/500, 1/1000, 1/2000, 1/5000, 1/10K).

### Sensitivity Up

Selects the factor by which the sensitivity of the camera is increased (OFF, 2x, 3x, ..., 10x).



#### NOTE!

If Sensitivity Up is active, some noise or spots may appear in the picture. This is normal camera behavior. Sensitivity Up may cause some motion blur on moving objects.

### Gain

In **AGC** mode the camera automatically sets the gain to the lowest possible value needed to maintain a good picture. Select



the maximum value the gain can have during AGC operation (0, 1, ... 26).

In **FIXED** mode the gain is set at a predefined not scene dependent value. Select the gain setting (0, 1, ... 26).

### 7.5.3 Day/Night



The Flexidome IP Day/Night camera is equipped with a motorized IR filter. The IR filter can be removed in low-light or IR illuminated applications. There are three different methods of switching:

- as part of the programmable mode profile,
- automatically, based on the observed light levels, or
- via the settings page.

If Auto switching mode is selected, the camera automatically switches the filter depending on the observed light level. The switching level is programmable. Set the video level at which the camera switches to monochrome operation (-15 to 0 to +15). In monochrome mode the IR filter is removed, giving full IR sensitivity.

In Auto switching mode set the camera priority:

- **Motion:** the camera gives sharp images without motion blur as long as the light level permits.
- **Color:** the camera gives color pictures as long as the light level permits.

The camera recognizes IR illuminated scenes to prevent unwanted switching to color mode. There are two modes for IR contrast:

- **Enhanced:** the camera optimizes contrast in applications with high IR illumination levels.
- **Normal:** the camera optimizes contrast in mono applications with visible light illumination.

## 7.5.4 Enhance

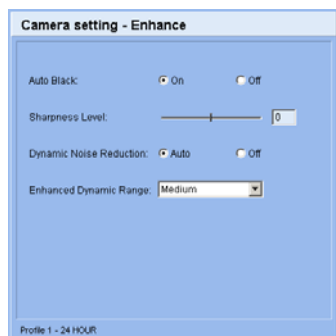

### Auto Black

Autoblack ON automatically increases the visibility of details.

### Black Level

Adjusts the black level between 0 and approximately 110mV. Zero position of slider corresponds to the factory default black level.

### Contour

Adjusts the sharpness of the picture. 0 corresponds to the default position.

### Dynamic Noise Reduction

In AUTO mode the camera automatically reduces the noise in the picture. This may cause some motion blur on moving objects.

### Enhanced Dynamic Range

In XF-DYN mode the camera automatically optimizes the contrast in the picture.

## 7.5.5 Color

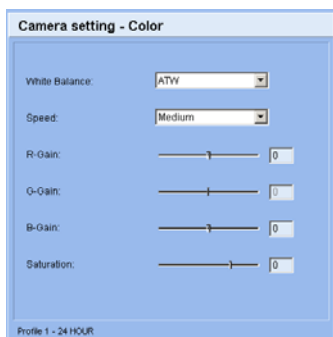

### White Balance

- **ATW:** Auto tracking white balance allows the camera to constantly adjust for optimal color reproduction.
- **AWB HOLD:** Puts the ATW on hold and saves the color settings.
- In **MANUAL** mode the Red, Green and Blue gain can be manually set to a desired position.

### WB Speed

Adjust the speed of the white balance control loop.

### Red Gain

ATW mode and AWB hold mode: adjusts the Red gain to optimize the white point.

### Green Gain

ATW mode and AWB hold mode: adjusts the Green gain to optimize the white point.

### Blue Gain

ATW mode and AWB hold mode: adjusts the B gain to optimize around the white point.

### Saturation

Adjusts the color saturation. -15 gives a monochrome image

## 7.5.6 Back Light Compensation (BLC)



When ON, the video level is optimized for the selected area of the image. Parts outside this area may be underexposed or overexposed (this is normal). To set-up an area for BLC, click **Area Selection**.

### Selecting an area

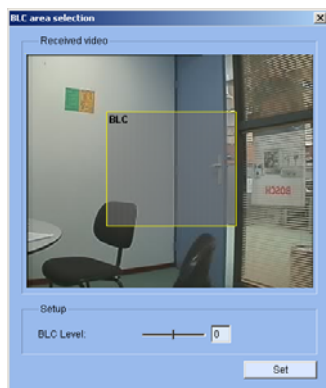

When you click **Area Selection** a pop-up window appears with a still picture of the received video. Use your mouse to select an area in the picture. BLC Level adjusts the balance between the selected BLC area and its surrounding.

## 7.5.7 Installer options

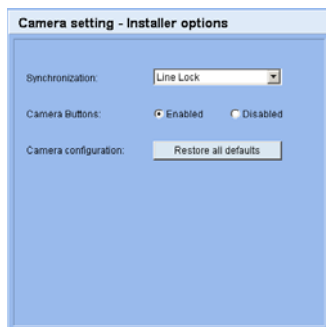

Select the synchronization method for the camera: **Internal** for free running camera operation; **Line Lock** to lock to the power supply frequency. You can disable the buttons on the camera to prevent unauthorized change of the camera settings.

- Click **Restore all defaults** to restore the factory defaults.
  - A confirmation screen appears. Allow 5 seconds for the camera to optimize the picture after a mode reset.

## 7.6 Recording

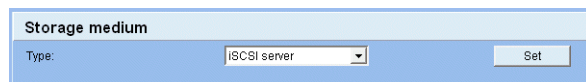

You can record the images from the camera in the RAM memory of the unit or in an appropriately configured iSCSI storage device. Local RAM memory is suitable for short-term recordings and pre-alarm recordings in Ring mode operation. For long-term, authoritative images, it is essential that you use appropriately sized iSCSI storage. It is also possible to let the Video Recording Manager (VRM) control all recording when accessing an iSCSI server. The VRM is an external program that configures recording tasks for video servers. For further information, contact your local customer service at Bosch Security Systems.

### 7.6.1 Type

Select the desired storage medium to subsequently configure the recording parameters.



#### NOTE!

If you select VRM, the Video Recording Manager manages all recording and you are not able to make any further configurations via the web browser.



#### CAUTION!

If you switch the storage medium from iSCSI server to RAM recording, the settings on the page iSCSI settings are lost and can only be restored by reconfiguring them.

### 7.6.2 Storage information

Storage information	
Status:	iSCSI server - iSCSI: session successful
Throughput (read/write):	0 kBit/s - 0 kBit/s <input type="button" value="Log"/>

The status of the currently selected storage medium and the data throughput are displayed here for information. You cannot change any of these settings.

1. Click **Log** to view a status report with logged actions. A new window opens.
2. In this window, click **Delete** to delete all entries. Entries are deleted immediately; you cannot undo this process.
3. Click **Close** to close the window.

## 7.7 iSCSI settings

### iSCSI settings

iSCSI IP address:

#### iSCSI LUN map

- 160.10.0.78
  - iqn.2002-10.com.infotrend:raid.sn6704104.00
    - iqn.2002-10.com.infotrend:raid.sn6704104.10
      - LUN 0 - Size 163772 MByte(s) - Owner
      - LUN 1 - Size 163772 MByte(s) - Locked by iqn.2005-12.com.bosch:unit00075f7030f2
      - LUN 2 - Size 163772 MByte(s) - Locked by iqn.2005-12.com.bosch:unit00075f71312c
      - LUN 3 - Size 163772 MByte(s) - Locked by iqn.2005-12.com.bosch:unit00075f7030fe
      - LUN 4 - Size 163772 MByte(s) - Locked by iqn.2005-12.com.bosch:unit00075f713119
      - LUN 5 - Size 163772 MByte(s) - Locked by iqn.2005-12.com.bosch:unit00075f713120
      - LUN 6 - Size 163772 MByte(s) - Locked by iqn.2005-12.com.bosch:unit00075f713122
      - LUN 7 - Size 163772 MByte(s) - Locked by iqn.2005-12.com.bosch:unit00075f71312b
      - LUN 8 - Size 163772 MByte(s) - Locked by iqn.2005-12.com.bosch:unit00075f7133bb
      - LUN 9 - Size 163772 MByte(s) - Locked by iqn.2005-12.com.bosch:unit00075f71340d
      - LUN 10 - Size 163772 MByte(s) - Locked by iqn.2005-12.com.bosch:unit00075f713410

Target IP address:

Target node:

Target LUN:

Target password:

Initiator name:

Initiator extension:

If you select type iSCSI server as the storage medium, you then need to set up a connection to the desired iSCSI storage device and set the configuration parameters.



**NOTE!** The storage device selected must adhere to the iSCSI specification, be available on the network and be completely set up. Amongst other things, it must have an IP address and be divided into logical drives (LUN).

### 7.7.1 iSCSI IP address

1. Enter the IP address of the required iSCSI server here.
2. Click **Connect**. The connection to the IP address is established. The iSCSI LUN map field contains the corresponding logical drives.

## 7.7.2 iSCSI LUN map

The LUN map displays the logical drives configured for the iSCSI storage device. The current user is displayed for each drive.

1. Double-click a free drive (LUN). The associated information is called up and automatically displayed in the fields below the map.
2. If the logical drive is password protected, you must first enter the password in the Target password field and click the **Set** button.



**NOTE!** When the information cannot be read due to the network topology you must enter the data manually so that the camera can access the drive. In this case you should ensure that the entries correspond exactly with the configuration of the iSCSI device.

3. After entering all the settings in the relevant fields, click **Set**. The camera attempts to create a connection to the required drive using this data.

As soon as a connection has been established, the selected drive is used for recordings.

## 7.7.3 Target IP address

Enter the IP address of the required iSCSI server here.

## 7.7.4 Target node

Enter the number of the iSCSI server target node.

## 7.7.5 Target LUN

Enter the LUN of the required drive.

## 7.7.6 Target password

If the drive is password protected, enter the password.



**NOTE!** You may not enter a new password. This is only possible by configuring the iSCSI storage device.



### 7.7.7 Initiator name

The initiator name is automatically displayed after a connection has been established.

### 7.7.8 Initiator extension

Enter the initiator extension. For the sake of clarity, you can enter a name or the existing extension with a comment, for example "- Camera 2".

### 7.7.9 Decoupling the drive used

Each drive can only be associated with one user. If a drive is already being used by another person, you can decouple the drive and connect the drive with the camera.

1. Double-click a drive that is already being used in the LUN map. You will see a warning message.
2. Confirm the decoupling of the current user. The drive is released and can be connected to the camera.

### 7.7.10 Storage information

Storage information	
Status:	ISCSI server - ISCSI: session successful
Throughput (read/write):	0 kBit/s - 0 kBit/s <input type="button" value="Log"/>

The status of the currently selected storage medium and the data throughput are displayed here for information. You cannot change any of these settings.

1. Click **Log** to view a status report with logged actions. A new window opens.
2. In this window, click **Delete** to delete all entries. Entries are deleted immediately; you cannot undo this process.
3. Click **Close** to close the window.

## 7.8 Partitioning

### Partitioning

Camera	Partition name	Alarm tracks	Type	Size (MByte)
01	RAM recording cam 1	0 alarm track(s) with 0 MByte(s)	Ring mode	8

Create partition
Edit partition
Partition status
Delete all partitions

Total memory: 0.0 MByte(s)

Internally used memory: 8.0 MByte(s)

Available memory: 8.0 MByte(s)

Number of partitions: 1 of 1 partitions created

Partitioned memory: 8.0 MByte(s)

Unpartitioned memory: 0.0 MByte(s)

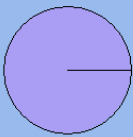

■ partitioned
 ■ unpartitioned

A partition can be set up for recordings of the camera in a similar manner to the partitioning often found on computer hard drives. Parameters such as size, quality and type of video recording or compression standard used can be specified for the partition. Modifying these parameters leads to reorganization, during which stored data is lost. In addition, the page provides you with an overview of the drive data; for example total memory. A pie chart indicates how much memory space is partitioned for recordings.

### 7.8.1 Creating a partition

Creating a new partition is performed using separate windows in which information is presented to you and you are led step by step through the necessary settings.

1. Click **Create partition** to start the wizard for creating partitions. The first window appears.

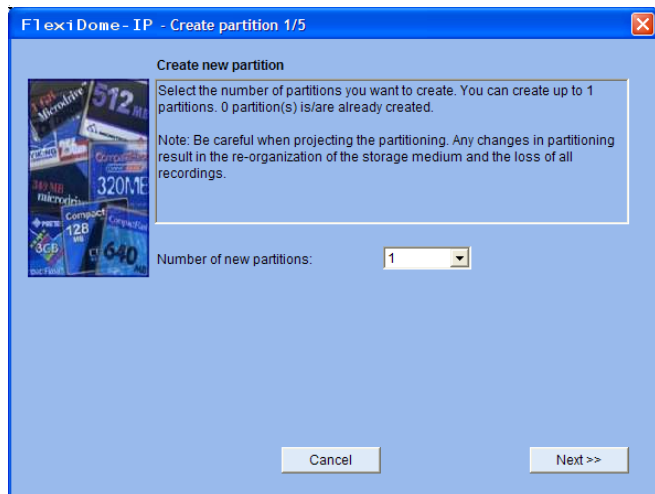

2. Read the information text in the upper section of the window.
3. Click in the text fields to enter values or use the other controls that are available, such as buttons, checkboxes or list fields.
4. Click **Next>>** in the lower section of the window to continue with the next step.
5. Click **<<Back** in the lower section of the window to view the previous step again.
6. Click **Cancel** to cancel the process and close the wizard.

### Saving changes

After you have made all necessary settings, you must transfer the settings to the unit and save them. To do this, you need to quit the help in the last window using the **Finish** button.



### CAUTION!

All modifications to settings are only effective if you complete the configuration in the last window by clicking **Finish**.

1. Switch to the last window if necessary.

2. Click **Finish** to complete the configuration. All settings are now transferred to the unit and subsequently become effective.

## 7.8.2 Partition status

1. Click **Partition status**.
  - A window opens showing information on the highlighted partition. This window provides information about the current configuration of the partition. No changes can be made here.

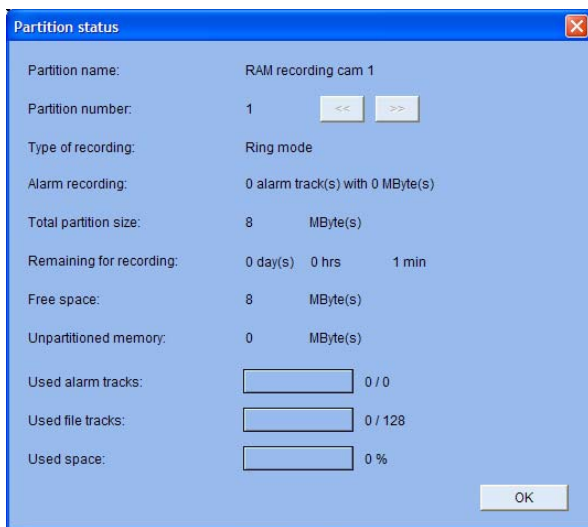

2. Click **OK** to close the window.

## 7.8.3 Editing a partition



**CAUTION!** Changes to a partition lead to a re-organization which results in the loss of all sequences stored on that partition. Consequently, you should back up all important sequences on the computer's hard drive before modifying the partition.

1. Click **Edit partition**.
  - A new window with the entries for the selected partition is opened. You can modify the configuration in the Partition properties window.

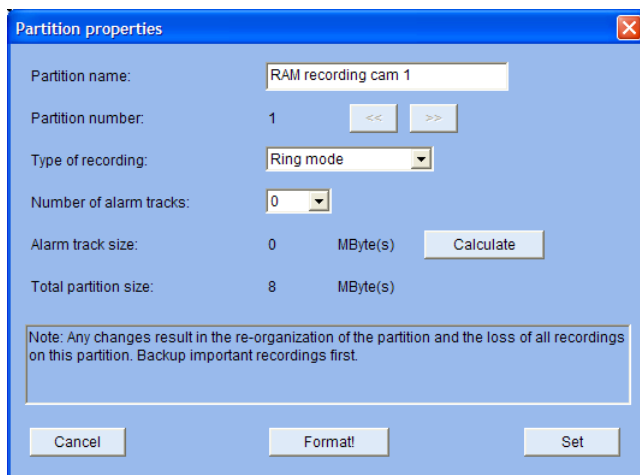

Partition properties

Partition name: RAM recording cam 1

Partition number: 1 << >>

Type of recording: Ring mode

Number of alarm tracks: 0

Alarm track size: 0 MByte(s) Calculate

Total partition size: 8 MByte(s)

Note: Any changes result in the re-organization of the partition and the loss of all recordings on this partition. Backup important recordings first.

Cancel Format! Set

2. Enter the necessary changes.
3. Click **Set** to save the modifications.
4. After closing the window, click **Set** in the main window to transfer the changes to the unit and to save them.

### Type of recording

Select the required recording type.

- In **Ring** mode the recording proceeds continuously. When the maximum hard drive space is reached, the oldest recordings are automatically overwritten.
- In **Linear** mode the recording proceeds until the entire hard drive space is full. The recording is then stopped until old recordings have been deleted.

### Number of alarm tracks



#### NOTE!

Alarm tracks must be set up for alarm recording.

The unit uses a special recording mode during alarm recording for optimal usage of storage capacity. As soon as a time gap for alarm recording begins, a recording is continuously made on one segment, which is the size of a complete alarm sequence (pre- and post-alarm time). This segment in the partition functions in a similar manner to a ring buffer and is overwritten until an alarm is actually triggered. Recording occurs on the segment only for the duration of the preset post-alarm time and a new segment is subsequently used in the same manner. Select the number of alarm tracks to be used in the partition. One alarm event can be recorded in each alarm track. Accordingly, the number of alarms entered can be recorded and archived. A partition can contain a maximum of 128 alarm recordings. If the **Ring** mode is set for a partition, the latest alarm recordings are always saved in the preset number. If the **Linear** mode is selected, the recording is stopped as soon as the total number of alarm tracks has been recorded.

### Alarm track size

The size for an alarm track can be calculated according to various parameters. The calculated size applies to all alarm tracks for the partition.

1. Click **Calculate**. A window opens.
2. Select the appropriate setting for each parameter from the list boxes.
3. Click **Set** to accept the calculated value.

### Format!

You can delete all recordings in a partition at any time.



### CAUTION!

Check the recordings before deleting and back-up important sequences on the computer's hard drive.

- Click **Format!** to delete all recordings in the current partition.

## 7.8.4 Deleting partitions

You can delete a partition at any time.



**CAUTION!** Deleting a partition leads to the entire hard drive being reorganized and loss of all sequences stored on the drive. Consequently, you should check the recordings before deleting any partition and back up important sequences on the computer's hard drive.

1. Click **Delete partition** button to delete the highlighted partition. The line containing the associated number remains in the display, the partition name is deleted and the size is indicated as 0.
2. Click **Set** to transfer the changes to the unit and to save them.

## 7.9 Recording profile

You can define up to ten separate recording profiles. You then assign these to individual days or times of day in the recording scheduler. Modify the names of the recording profiles on the tabs in the **Recording planner** page.

### Recording profiles

Day
Night
Weekend

Camera	Standard profile	Encoder	Post-alarm profile
Camera 1	Low bandwidth (CIF)	Stream 1	Standard profile

Settings for selected camera(s)

Standard recording

Standard profile: Low bandwidth (CIF)

Encoder: Stream 1

Pre-alarm recording

Alarm track recording:  0 alarm track(s) with 0 MByte(s)

Pre-alarm time: 0 sec

Post-alarm recording

Post-alarm time: 0 sec

Post-alarm profile: Standard profile

Default

Copy settings

Set

Recording active on partition 1. No changes to partition properties possible!

1. Click one of the tabs to edit the corresponding profile.
2. Click **Default** to return all settings to their defaults.
3. Click **Copy settings** if you want to copy the currently visible settings to another profile. A dialog appears and you can select the target profile for the copied settings.
4. Click **Set** in each profile tab that you want saved.

### Standard profile

Select the encoder profile to use for continual recording.



#### NOTE!

The recording profile can deviate from the standard setting **Active** profile and is only used during an active recording.

### Encoder

Select which data stream to record here.



**Alarm track recording**

This parameter is only active, if the alarm tracks have been configured.

- Click the checkbox to activate alarm track recording. The pre-alarm time gap is displayed automatically.

**Post-alarm time**

Select the post-alarm time gap from the list box.

**Post-alarm profile**

Select the encoder profile to use for recording during the post-alarm time. The **Standard profile** option sets this to the same as the standard profile.

**Motion detection/video alarm**

Select the alarm type that is to trigger a recording.

## 7.10 Recording scheduler

Set all parameters for recording. Recording can be performed continuously or when an alarm occurs.

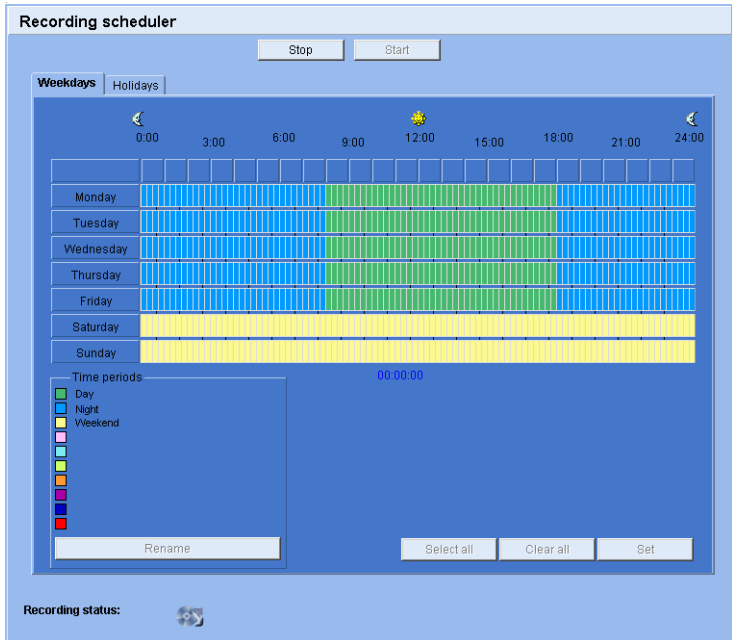

In the recording scheduler you can assign weekdays and times to the recording profiles you have created that define when alarms trigger recording. You can assign as many time periods (in 15-minute intervals) for any day of the week. When you move the mouse cursor over the table, the time is displayed. In addition to weekdays, you can also define holidays which override the settings for that weekday. This allows you to apply the settings for Sundays to other days of the week.

1. Click a profile.
2. Click a field in the table, and holding down the left mouse button, drag the cursor across all of the fields to be assigned to the selected profile.
3. Use the right mouse button to deselect any of the intervals.
4. Click **Select all** to select all of the intervals to be assigned to the selected profile.

5. Click **Clear all** to deselect all of the intervals.
6. When you are finished, click **Set** to save the settings in the device.

### Holidays

You can define holidays, which will override the settings for the normal weekly schedule. This allows you to apply the settings for Sundays to other days of the week.

1. Click the **Holidays** tab. Days that have already been defined are shown in the table.
2. Click **Add**. This opens a new window.
3. Select the desired date from the calendar. Drag the mouse to select a range of dates. These are handled as a single entry in the table.
4. Click **OK** to accept the selection(s). The window closes.
5. Assign the defined holidays to the recording profile as described above.

### Delete holidays

You can delete user-defined holidays at any time.

1. Click **Delete** in the **Holidays** tab. This opens a new window.
2. Click the date to be deleted.
3. Click **OK**. The selection is removed from the table and the window closed.
4. Repeat for any other dates to be deleted.

### Profile names

You can change the names of the recording profiles.

1. Select a profile by clicking and then click **Rename**.
2. Enter the desired name and click **Rename** again.

## 7.10.1 Activating recording

After configuration, you must activate the recording schedule and initiate recording. Once activated, the Recording profiles and the Recording scheduler are deactivated and the configuration cannot be modified. You can terminate recording at any time to modify the configuration.

1. Click **Start** to activate the recording schedule.

2. Click **Stop** to deactivate the recording schedule. Recordings that are currently running are interrupted and the configuration can be modified.

## 7.10.2 Recording status

The graphic indicates the recording activity in this partition. You will see an animated graphic while recording is taking place.

## 7.11 Alarm Settings

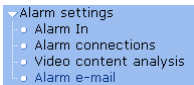

### 7.11.1 Alarm in



You can configure the possible alarm triggers for the camera. Alarm input Select **Active Low** if the alarm is to be triggered by closing the contact. Select **Active High** if the alarm is to be triggered by opening the contact.

#### Action

Select how the camera responds to an incoming alarm. The camera can either switch the camera settings profile (not the recordings profile) or switch to Night mode. If **None** is selected, the alarm will only be forwarded via the IP connection.

#### Name

You can enter a name for each alarm input, which is then displayed below the icon for the alarm input on the **Livepage** during configuration.

## 7.11.2 Alarm connections

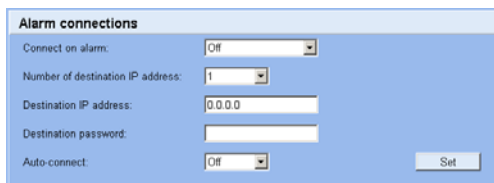

You can select the response of the camera when an alarm occurs. In case of an alarm, the camera can automatically establish a connection to a predefined IP address (compatible MPEG-4 compatible hardware receiver or computer with reception software). You can enter up to ten IP addresses which will be selected in order by the unit in case of an alarm until a connection is established.

### Connect on alarm

Select **On** so that the camera automatically establishes a connection to a pre-defined IP address in the event of an alarm.



### NOTE!

Stream 2 is always transmitted for alarm connections. This should be taken into account when assigning the profile.

### Number of destination IP address

Here you assign the numbering for the IP addresses to be contacted in the event of an alarm. The unit contacts the remote locations one after the other in the numbered sequence until a connection has been established.

### Destination IP address

For each number, enter the corresponding IP address for the desired remote location.

### Destination password

If the remote location is password protected, enter the password here.

Only ten passwords can be defined here. You can define a general password if more than ten connections are required, for

example when connections are initiated by a controlling system such as VIDOS or BVMS. The camera connects to all devices protected by the same general password. To define a general password:

1. Select 10 in the **Number of Destination IP-address** list box.
2. Enter 0.0.0.0 in the **Destination IP-address** field.
3. Enter the password in the **Destination password** field.
4. Set the user password of all the devices to be connected to this password.

Setting destination 10 to the IP-address 0.0.0.0 overrides its function as the tenth address to try.

### **Destination port**

Choose the browser-port, depending on the network configuration. Port 443 for HTTPS connections is only available if the **On** option in SSL encryption is selected.

### **SSL encryption**

SSL encryption can be used to protect data, such as the password used for establishing a connection. If you select **On**, only encrypted ports are available for the destination port. SSL encryption must be activated and configured on both sides of a connection. The appropriate certificates must also have been uploaded (see “SSL certificate upload” on page 99). You can configure and activate encryption for media data (video, audio, metadata) on the Encryption page (see “Encryption” on page 92).

### **Auto-connect**

Select **On** if an active connection should be re-established automatically to one of the previously specified IP addresses after each restart, connection breakdown or network failure.



#### **NOTE!**

Stream 2 is always transmitted for automatic connections. This should be taken into account when assigning the profile.

## 7.12 VCA

**VCA**

**Video 1**

Analysis:

Analysis type:  Alarm state:

**Motion detector**

Sensitivity:  (Low High)

Min. object size:

Global change %:

**Tamper detection**

Sensitivity:

Trigger delay (sec):

Scene too bright   Scene too noisy

Scene too dark   Reference check

The camera contains an integrated Video Content Analysis (VCA), which can detect and analyze changes in the signal. Such changes can be due to movements in the camera's field of view. You can configure the video content analysis for the camera. If necessary, click **Default** to return all settings to their default values.

### 7.12.1 Analysis

Select the option **On** to activate the video content analysis. As soon as the VCA is activated, metadata are created. Depending on the analysis type selected and the relevant configuration, additional information overlays the video image in the small window. If you select **Motion+** analysis, for example, the sensor fields in which movement is registered light up.

**NOTE!**

On the **Livepage configuration** page, you can enable additional information overlays for the live video image too (see “Livepage configuration” on page 94).

### 7.12.2 Analysis type

Select the required analysis algorithm. By default, only **Motion+** is available – this offers a motion detector and essential recognition of tampering. The current alarm status is displayed for information purposes.

**NOTE!**

Additional analysis algorithms with comprehensive functions such as IVMD are available from Bosch Security Systems.

### 7.12.3 Motion detector

Motion detection is available for the **Motion+** analysis type. For the detector to function, the following conditions must be met:

- Analysis must be activated.
- At least one sensor field must be activated.
- The individual parameters must be configured to suit the operating environment and the desired responses.
- The sensitivity must be set to a value greater than zero.



**NOTE!** Reflections of light (off glass surfaces, etc.), switching lights on or off or changes in the light level caused by cloud movement on a sunny day can trigger unintended responses from the motion detector and generate false alarms. Run a series of tests at different times of the day and night to ensure that the video sensor is operating as intended.

**NOTE!**

For indoor surveillance, ensure constant lighting of the areas during the day and at night.



### 7.12.4 Sensitivity

Sensitivity is available for the **Motion+** analysis type. The basic sensitivity of the motion detector can be adjusted for the environmental conditions to which the camera is subject. The sensor reacts to variations in the brightness of the video image. The darker the observation area, the higher the value that must be selected.

#### **Min. object size**

You can specify the number of sensor fields that a moving object must cover to generate an alarm. This setting prevents objects that are too small from triggering an alarm. A minimum value of 4 is recommended. This value corresponds to four sensor fields.

#### **Global change %**

You can define the percentage of sensor fields that must register a change simultaneously before generating an alarm. This setting is independent of the sensor fields selected under **Select area**. This option allows you to detect, independently of motion alarms, manipulation of the orientation or location of a camera resulting from turning the camera mounting bracket, for instance.

#### **Selecting the area**

The areas of the image to be monitored by the motion detector can be selected. The video image is subdivided into 858 square sensor fields. You can activate or deactivate each of these fields individually. If you wish to exclude particular regions of the camera's field of view from monitoring due to continuous movement (by a tree in the wind, etc.), the relevant fields can be deactivated.

1. Click **Select area** to configure the sensor fields. A new window opens.
2. If necessary, click **Clear all** first to clear the current selection (fields marked red).
3. Left-click the fields to be activated. Activated fields are marked red.

4. If necessary, click **Select all** to select the entire video frame for monitoring.
5. Right-click any fields you wish to deactivate.
6. Click **OK** to save the configuration.
7. Click the close button (**X**) in the window title bar to close the window without saving the changes.

### 7.12.5 Tamper detection

You can detect the tampering of cameras and video cables by means of various options. Run a series of tests at different times of the day and night to ensure that the video sensor is operating as intended.

#### Sensitivity



#### NOTE!

This and the following parameter are only accessible if the reference check is activated.

The basic sensitivity of the tamper detection can be adjusted for the environmental conditions to which the camera is subject. The algorithm reacts to the differences between the reference image and the current video image. The darker the observation area, the higher the value that must be selected.

#### Trigger delay

You can set delayed alarm triggering. The alarm is only triggered after a set time interval in seconds has elapsed and then only if the triggering condition still exists. If the original condition has been restored before this time interval elapses, the alarm is not triggered. This allows you to avoid false alarms triggered by short-term changes, for example cleaning activities in the direct field of vision of the camera.

#### Scene too bright

Activate this function if tampering associated with exposure to extreme light (for instance, shining a flashlight directly on the

objective) should trigger an alarm. The average brightness of the scene provides a basis for recognition.

### **Scene too dark**

Activate this function if tampering associated with covering the objective (for instance, by spraying paint on it) should trigger an alarm. The average brightness of the scene provides a basis for recognition.

### **Scene too noisy**

Activate this function if tampering associated with EMC interference (noisy scene as the result of a strong interference signal in the vicinity of the video lines) should trigger an alarm.

### **Reference check**

You can save a reference image that is continuously compared with the current video image. If the current video image in the marked areas differs from the reference image, an alarm is triggered. This allows you to detect tampering that would otherwise not be detected, for example if the camera is turned.

1. Click **Reference** to save the currently visible video image as a reference.
2. Click **Select area** and select the areas in the reference image that are to be monitored.
3. Check the box **Reference check** to activate the on-going check. The stored reference image is displayed in black and white below the current video image, and the selected areas are marked in red.

### **Selecting the area**

You can select the image areas in the reference image that are to be monitored. The video image is subdivided into 858 square fields. You can activate or deactivate each of these fields individually.



#### **NOTE!**

Select only those areas for reference monitoring in which no movement takes place and that are always evenly lit, as false alarms could otherwise be triggered.

1. Click **Select area** to configure the sensor fields. A new window will open.
2. If necessary, click **Clear all** first to clear the current selection (fields marked red).
3. Left-click the fields to be activated. Activated fields are marked red.
4. If necessary, click **Select all** to select the entire video frame for monitoring.
5. Right-click any fields you wish to deactivate.
6. Click **OK** to save the configuration.
7. Click the close button (**X**) in the window title bar to close the window without saving the changes.

## 7.13 Alarm e-mail

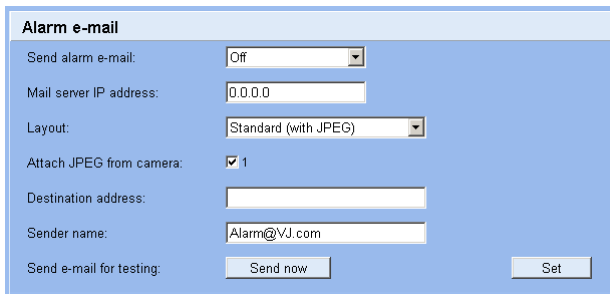

The screenshot shows a configuration window titled "Alarm e-mail" with a light blue background. It contains the following fields and controls:

- Send alarm e-mail:** A dropdown menu currently set to "Off".
- Mail server IP address:** A text input field containing "0.0.0.0".
- Layout:** A dropdown menu currently set to "Standard (with JPEG)".
- Attach JPEG from camera:** A checked checkbox with the number "1" next to it.
- Destination address:** An empty text input field.
- Sender name:** A text input field containing "Alarm@VJ.com".
- Send e-mail for testing:** A section containing two buttons: "Send now" and "Set".

As an alternative to automatic connecting, alarm states can also be documented by e-mail. In this way it is possible to notify a recipient who does not have a video receiver. In this case the camera automatically sends an e-mail to a user defined e-mail address.

### 7.13.1 Send alarm e-mail

Select **On** if you want the unit to automatically send an alarm e-mail in the event of an alarm.

### 7.13.2 Mail server IP address

Enter the IP address of a mail server that operates on the SMTP standard (Simple Mail Transfer Protocol). Outgoing e-mails are

sent to the mail server via the address you entered. Otherwise leave the box blank (0.0.0.0).

### 7.13.3 Layout

You can select the data format of the alarm message.

- Standard (with JPEG): e-mail with JPEG image file attachment.
- SMS: e-mail in SMS format to an e-mail-to-SMS gateway (for example to send an alarm by cellphone) without an image attachment.



**NOTE!** When a cellphone is used as the receiver, make sure to activate the e-mail or SMS function, depending on the format, so that these messages can be received. You can obtain information on operating your cellphone from your cellphone provider.

### 7.13.4 Destination address

Enter the e-mail address for alarm e-mails here. The maximum address length is 49 characters.

### 7.13.5 Sender name

Enter a unique name for the e-mail sender, for example the location of the unit. This makes it easier to identify the origin of the e-mail.

### 7.13.6 Send e-mail for testing

Test the e-mail function by clicking **Send now**. An alarm e-mail is immediately created and sent.

## 7.14 Relay Settings

▼ Relay settings  
• Alarm Out

Here, you can make the settings for the alarm sources and alarm connections.

## 7.14.1 Alarm out

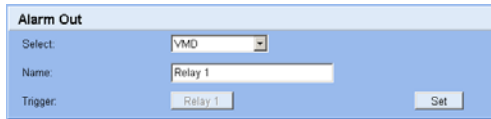

The screenshot shows a web interface for configuring an alarm output. The title is "Alarm Out". There are three main sections: "Select:" with a dropdown menu currently showing "VMD"; "Name:" with a text input field containing "Relay 1"; and "Trigger:" with a button labeled "Relay 1". A "Set" button is positioned to the right of the "Trigger:" field.

Select the event that will trigger the alarm output;

- an internal motion detection/VCA,
- an internal day/night switching, or
- an external trigger from the network.

For example, it is possible to switch on a spotlight in response to a motion alarm and switch it off again when the alarm is over.

### Relay name

The relay can be assigned a name here. The name is shown on the button next to Trigger relay. The **Livepage** can also be configured to display the name next to the relay icon.

### Trigger relay

Click the button to switch the relay manually (for example for testing purposes or to operate a door opener).

## 7.15 Service Settings

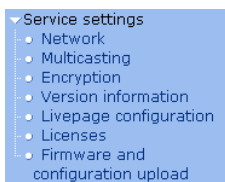

### 7.15.1 Network

**Network**

**Ethernet**

IP address:  Reboot after 'Set' necessary!

Subnet mask:  Reboot after 'Set' necessary!

Gateway address:  Reboot after 'Set' necessary!

Video transmission:

HTTP browser port:

HTTPS browser port:

Ethernet link type:

---

**SNMP**

1. SNMP host address:

2. SNMP host address:

SNMP traps:

---

**802.1X**

Authentication:

Identity:

Password:

---

**DHCP**

Automatic IP assignment:

The settings on this page are used to integrate the unit into an existing network.



#### NOTE!

Changes to the IP address, subnet mask or gateway address are transferred to the unit by clicking **Set**. However, they do not become active until the device is restarted.

- Click **Set** after entering a new IP address.
  - To do this, enter the old IP address followed by / reset (for instance 192.168.0.80/reset) in the address bar of your web browser. When the camera is

restarted it can only be accessed at the new IP address.

### **IP address**

Enter the desired IP address for the camera in this field. The IP address must be valid for the network.

### **Subnet mask**

Enter the appropriate subnet mask for the set IP address here.

### **Gateway address**

If you want the unit to establish a connection to a remote location in a different subnet, enter the IP address of the gateway here. Otherwise, this field can remain empty (0.0.0.0).

### **Video transmission**

If the unit is used behind a firewall, TCP (Port 80) should be selected as the transmission protocol. For use in a local network, choose UDP.



#### **NOTE!**

Multicast operation is only possible with the UDP protocol. The TCP protocol does not support multicast connections. The MTU value in UDP mode is 1514 bytes.

### **HTTP browser port**

Select a different HTTP browser port from the list if required. The default HTTP port is 80. To limit connection to HTTPS you must deactivate the HTTP port. To do this activate the **Off** option.

### **HTTPS browser port**

To limit browser access to encrypted connections, choose an HTTPS port from the list. The standard HTTPS port is 443. By activating the **Off** option, you can deactivate HTTPS ports and limit connections to unencrypted ports.

The camera uses the TLS 1.0 protocol. Ensure that the browser has been configured to support this protocol. Also ensure that Java application support is activated (in the Java Plug-in Control Panel of the Windows Control Panel).



If you want to limit connections to SSL encryption, you must set the **Off** option in the HTTP browser port, the RCP+ port, and Telnet support. This deactivates all unencrypted connections allowing connections on the HTTPS port only.

**NOTE!**

You can configure and activate encryption for media data (video, audio, metadata) on the **Encryption** page (see “Encryption” on page 92).

**RCP+ port 1756**

Activating RCP+ port 1756 allows unencrypted connections on this port. If you want to allow only encrypted connections, you must set the **Off** option to deactivate the port.

**Telnet support**

Activating Telenet support allows unencrypted connections on this port. If you want to allow only encrypted connections, you must set the **Off** option to deactivate telnet support, making telnet connections impossible.

**Ethernet link type**

If the camera is connected to the network via a switch, both devices must have the same preset network connection type. If necessary, ask your network administrator what value the associated switch is set to.

Choose Auto for an autosensing network connection. If necessary you can set the value to 10 or 100 MBit/s for either full or half-duplex mode (FD or HD).

**NOTE!**

Malfunctions can occur (for example image faults) if the network capacity is not sufficient for transmission of the maximum data rate generated by the camera.

**1. SNMP host address / 2. SNMP host address**

The camera supports the SNMP V2 (Simple Network Management Protocol) for managing and monitoring network compo-

nents and can send SNMP messages (traps) to IP addresses. It supports SNMP MIB II in the unified code. If you wish to send SNMP traps, enter the IP addresses of one or two required target devices here.

To choose which traps are sent:

1. Click **Select**. A dialog box appears.
2. Click the check boxes of the appropriate traps.
3. Click **OK** to close the window and send all of the checked traps.

### Authentication

If a Radius server controls access rights in the network, you must activate authentication to communicate with the device.

1. Enter the user name that the Radius server uses for the camera in the identity field.
2. Enter the password that the Radius server expects from the camera.

The Radius server must also be appropriately configured.

### Automatic IP assignment

If the network has a DHCP server for dynamic IP allocation, you can activate DHCP here. In this case, the IP entered above on this page is overwritten the next time the camera restarts.



**NOTE!** The DHCP server must be configured to allocate static IP addresses based on MAC addresses so that the camera always receives the same address. If not, controlling systems, such as VIDOS or BVMS, will not find the camera.

## 7.15.2 Multicasting

In addition to a 1:1 connection between an encoder and a single receiver (unicast), the camera can enable multiple receivers

to receive the video signal from an encoder simultaneously. This is either done by duplicating the data stream in the unit and then distributing it to multiple receivers (multi-unicast) or by distributing an individual data stream in the network itself to multiple receivers in a defined group (multicast). You can enter a dedicated multicast address and port for each stream. You can switch between the streams by clicking the associated tabs.



**NOTE!** The prerequisite for multicast operation is a multicast-capable network that uses the UDP and IGMP protocols. Other group membership protocols are not supported. The TCP protocol does not support multicast connections.

A special IP address (class D address) must be configured for multicast operation in a multicast-enabled network. The network must support group IP addresses and the Internet Group Management Protocol (IGMP V2). The address range is from 225.0.0.0 to 239.255.255.255. The multicast address can be the same for multiple streams. However, it is then necessary to use a different port in each case so that multiple data streams are not sent simultaneously using the same port and multicast address.

#### **Multicast address video 1**

Enter a valid multicast address for each stream to be operated in multicast mode (duplication of the data streams in the network). With the setting 0.0.0.0 the encoder for the relevant stream operates in multi-unicast mode (copying of data streams in unit). The camera supports multi-unicast connections for up to five simultaneously connected receivers.



**NOTE!** Duplication of data places a heavy demand on the CPU and can lead to impairment of the image quality under certain circumstances.

### Port

If there are simultaneous data streams at the same multicast address, you must assign different ports to each data stream. Enter the port address for the relevant stream here.

### Streaming

Click in the checkbox to activate multicast streaming mode for the relevant stream. An activated stream is marked with a check.

### Multicast packet TTL

A value can be entered to specify how long the multicast data packets are active on the network. If multicast is to be run via a router the value must be greater than 1.

## 7.15.3 Encryption

You can activate the encryption of media data (video, audio, metadata) here. Activation also causes RCP+ connections to be encrypted. To encrypt data streams, you should only allow browser connections via SSL. To do this, you must deactivate all ports and protocols except HTTPS (see “HTTPS browser port” on page 88).



### NOTE!

Encrypting video data requires a lot of computing power.

You can select individual data streams for encryption. When a key is generated for a stream, data is encrypted. If you delete the key, data is unencrypted for that stream.

1. Select **On** in the encryption list box to activate encryption. Activation generates keys for all streams.
2. Click **Keys >>** to display a list of data streams and associated keys.
3. Click an entry to select it (select multiple entries by holding the control key while clicking).
4. Click **Clear keys** to delete the keys for the marked streams. These streams are no longer encrypted.

5. Click **Generate keys** to generate new keys for marked streams.
6. Click **Edit** to enter a key for a marked entry manually.

#### **Automatic key exchange:**

Mark this checkbox to activate an automatic key exchange between two devices (or the camera and a software decoder) across an encrypted connection.

### **7.15.4 Version information**

Version information	
Hardware version:	F0001142
Firmware version:	065002500108
Device type:	FlexDome
Audio option:	No
Storage medium attached:	Yes
MAC address:	00-04-83-20-59-10
Major version number:	2.50
Build number:	6
Camera firmware version:	1.08

This window is for information only and cannot be modified. Keep this information at hand when seeking technical support. For example, you can copy the hardware and firmware version numbers to paste them into an e-mail.

## 7.15.5 Livepage configuration

In this window, you can adapt the appearance of the **Livepage** to meet your requirements. Options are provided here to display various information and operating elements in addition to the video image. Moreover, individual background graphics can be used for the main window and the upper area of the window (banners).



**NOTE!** Either GIF or JPEG images can be used. The file paths must correspond to the access mode (for example C:\Images\Logo.gif for access to local files or <http://www.myhostname.com/images/logo.gif> for access via the Internet/Intranet).

For access via the Internet/Intranet, there must be a connection in order to display the image. The image files are not stored on the camera.

1. Mark the check boxes for the information to be displayed on the **Livepage**. The selected elements are checked.
2. Check on the **Livepage** whether and how the desired items are displayed.

**Logo URL**

Enter the path to a suitable background graphic in this field. The image can be stored on a local computer, a local network or at an Internet address.

- Click **Search** if necessary to find a suitable image on the local network.

**Device logo URL**

Enter the path for a suitable image for the upper part of the window (banner) here. The image can be stored on a local computer, a local network or at an Internet address.

- Click **Search** if necessary to find a suitable image on the local network.

**NOTE!**

To restore the original graphics, simply delete the entries in the Logo URL and Device logo URL fields.

**Show alarm input**

Alarm inputs are displayed next to the video image as icons along with their assigned names. If an alarm is active the corresponding icon changes color.

**Show VCA metadata**

When video content analysis (VCA) is activated, additional information is displayed in the live video stream. For example, in **Motion+** mode, the sensor areas for motion detection are marked.

**Show VCA trajectories (IVMD 2.0 only)**

When the IVMD 2.0 algorithm is activated, object trajectories from VCA are displayed in the live video stream.

**Show event log**

The event messages are displayed with the date and time in a field next to the video image.

### Show system log

The system messages are displayed with the date and time in a field next to the video image and provide information about the establishment and termination of connections etc.

### Save event log

Select this option to save event messages in a text file on the local computer. This file can be viewed, edited and printed with any text editor or the standard Office software.

### Save system log

Select this option to save system messages in a text file on the local computer. This file can be viewed, edited and printed with any text editor or the standard Office software.

### File for event log

Enter the path for saving the event log here.

- If necessary, click **Search** to find a suitable folder.

### File for system log

Enter the path for saving the system log here.

- If necessary, click **Search** to find a suitable folder.

### Path for JPEG and MPEG files

Enter the path for the storage location of individual images and video sequences that you can save from the Livepage.

- If necessary, click **Search** to find a suitable folder.

## 7.15.6

### Licenses

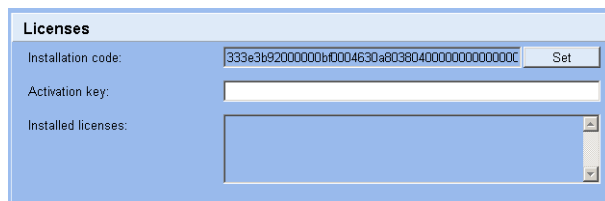

Licenses	
Installation code:	<input type="text" value="333e3b692000000b10004630a803804000000000000000"/> <input type="button" value="Set"/>
Activation key:	<input type="text"/>
Installed licenses:	<div style="border: 1px solid gray; height: 40px; width: 100%;"></div>

You can enter the activation key to release additional functions or software modules.



**NOTE!**

The activation key cannot be deactivated again and is not transferable to other units.

### 7.15.7 Maintenance

Firmware and configuration upload	
Firmware update:	<input type="text"/> <input type="button" value="Browse..."/> <input type="button" value="Upload"/>
Upload progress:	<input type="text" value="0%"/>
Configuration download:	<input type="button" value="Download"/>
Configuration upload:	<input type="button" value="Upload"/>



**CAUTION!** Before starting the firmware update, make sure that you have selected the correct upload file! Uploading the wrong files can result in the unit no longer being addressable, requiring it to be replaced.



**CAUTION!** Do not interrupt the firmware installation for any reason! Interruption may lead to faulty coding of the Flash EPROM. This can result in the unit no longer being addressable, requiring it to be replaced.

#### Firmware update

The camera functions and parameters can be updated with firmware. To do this, the current firmware package is transferred to the unit via the network. The firmware is installed there automatically. Thus a camera can be serviced and updated remotely without requiring a technician to make changes to the unit on site. The latest firmware can be obtained from your customer service center or from the Bosch Security Systems download area.



**NOTE!** A firmware update resets all camera parameters to their factory default values. If you wish to retain the old values first save the configuration by performing a configuration download. After the firmware update you can reload your parameter values by performing a configuration upload.

To update the firmware:

1. First, save the update file to the hard disk.
2. Enter the full path for the update file in the field or click **Browse...** to locate and select the file.
3. Click **Upload** to begin transmission to the unit. The progress bar allows you to monitor the transfer.



**NOTE!**

Installing new firmware and reconfiguring the camera takes several minutes.

The new firmware is unpacked and the Flash EPROM is reprogrammed. The time remaining is shown by the message going to reset **Reconnecting in ...** seconds. After the upload is completed successfully, the unit restarts automatically.

If the operating status LED lights up red, the upload has failed and must be repeated. To perform the upload, you must switch to a special page:

1. In the address bar of your browser, after the unit IP address enter  
/main.htm (for example 192.168.0.80/main.htm).
2. Repeat the upload.

### **Configuration download**

You can save configuration data for the camera to a computer and load saved configuration data from a computer to the unit.

1. Click **Download**; a dialog box appears.
2. Follow the instructions to save the current settings.

### Configuration upload

1. Enter the full path of the file to upload or click **Browse...** to select the desired file.
2. Make certain that the file to be loaded comes from the same device type as the unit you want to reconfigure.
3. Click **Upload** to begin transmission to the unit. The progress bar allows you to monitor the transfer.

Once the upload is complete, the new configuration is activated. The time remaining is shown by the message going to reset **Reconnecting in ...** seconds. After the upload is completed successfully, the unit restarts automatically.

### SSL certificate upload

To work with an SSL connection, both sides of the connection must have the appropriate certificates. You can upload one or more certificate files, one at a time, to the camera.

1. Enter the full path of the file you wish to upload or click **Browse...** to locate the file.
2. Click **Upload** to start the file transfer.

The unit restarts automatically after a successful upload.

## 7.16 Function test

The camera offers a variety of configuration options. Therefore you should check that it works properly after installation and configuration. This is the only way to ensure that the camera will function as intended in the event of an alarm.

Your check should include the following functions:

- Can the camera be called remotely?
- Does the camera transmit all the data required?
- Does the camera respond as desired to alarm events?
- Is it possible to control peripheral devices if necessary?

## 8 Connections between video servers

A camera can be used as a transmitter and a compatible MPEG4 hardware decoder with a connected monitor as a receiver using an Ethernet network connection. This way it is possible to cover large distances with little effort for installation or cabling.

### 8.0.1 Installation

Cameras are designed to connect with other VIP devices automatically with the corresponding configuration. This only requires that they are part of a closed network. Proceed as follows to install the devices:

1. Connect the devices to the closed network using Ethernet cables.
2. Connect them to the power supply.



**NOTE!** Make sure the devices are configured for the network environment and the correct IP address for the remote location to be contacted in the event of an alarm is set on the Alarm connections configuration page.

### 8.0.2 Establishing the connection

There are three options for establishing a connection between a transmitter and a compatible receiver in a closed network:

- an alarm,
- a Web browser
- via the configuration manager

### 8.0.3 Connect on alarm

With the appropriate configuration, a connection between a transmitter and a receiver is established automatically when an alarm is triggered. After a short time, the live video image from the transmitter is shown on the connected monitor.

This connection option can also be used to connect a transmitter and a compatible receiver using a switch connected to the alarm input. In this case, no computer is needed to establish the connection.

## 8.0.4 Connecting with a Web browser

Various requirements must be met in order to operate using a Web program.



### NOTE!

Transmitter and receiver must be located in the same subnet to establish a hardware connection with a Web browser.

1. Use the Web browser to connect to the receiver. Its home page is displayed.

Under Video sources on the page **Connections**, select the camera. A JPEG snapshot of the selected video source is displayed on the page.

2. Click an MPEG-4 connection to begin displaying the video images on the connected monitor.

## 8.0.5 Closing the connection

The connection may be closed using a Web browser.

1. Use the Web browser to connect to the receiver. Its home page is displayed.
2. In the title bar of the Monitor window on the page **Connections**, click the **X** icon to end the display of the video images on the connected monitor.

## 9 Operation with decoder software

### VIDOS

The camera video server and VIDOS software combine to provide a high-performance system solution. VIDOS is software for operating, controlling and administering CCTV installations (such as surveillance systems) at remote locations. It runs under Microsoft Windows operating systems. Its main job is decoding video, audio and control data from a remote transmitter. There are many options available for operation and configuration when using a camera with VIDOS.

### BVMS

The Bosch Video Management System (BVMS) is a unique enterprise IP video security solution that provides seamless management of digital video, audio and data across any IP network. It is designed to work with Bosch CCTV products as part of a total video security management system. Now you can integrate your existing components into one easy-to-manage system, or use Bosch's full-line capabilities and benefit from a complete security solution based on cutting-edge technology and years of experience.

### DiBos 8

The camera is also designed for use with DiBos 8 Video Recorders. DiBos 8 can record up to 32 video and audio streams, and is available as software or a hybrid DVR with additional analog camera and audio inputs. DiBos supports various functions of the camera, such as controlling relays, remote control of peripheral devices and remote configuration. DiBos 8 can use alarm inputs to trigger actions and, when motion detection **Motion+** is active, can record the relevant cells, making intelligent motion detection possible.

## 10 Maintenance

### 10.1 Testing the network connection

The `ping` command can be used to check the connection between two IP addresses. This allows you to test whether a device is active in the network.

1. Open the DOS command prompt.
2. Type `ping` followed by the IP address of the device.

If the device is found, the response appears as "Reply from ...", followed by the number of bytes sent and the transmission time in milliseconds. Otherwise, the device cannot be accessed via the network. This might be because:

- The device is not properly connected to the network.  
Check the cable connections in this case.
- The device is not correctly integrated into the network.  
Check the IP address, subnet mask and gateway address.

### 10.2 Repairs



**CAUTION!** Never open the casing of the camera. The unit does not contain any user serviceable parts. Ensure that all maintenance or repair work is performed only by qualified personnel (electrical engineering or network technology specialists). In case of doubt, contact your dealer's technical service center.

#### 10.2.1 Transfer and disposal

The camera should only be passed on together with this installation guide. The unit contains environmentally hazardous materials that must be disposed of according to law. Defective or superfluous devices and parts should be disposed of professionally or taken to your local collection point for hazardous materials.

# 11 Troubleshooting

If you cannot resolve a fault, please contact your supplier or system integrator or go direct to Bosch Security Systems Customer Service.

The version numbers of the internal processors can be viewed on a special page. Please note this information before contacting Customer Service.

1. In the address bar of your browser, after the unit IP address enter

/version (for example 192.168.0.80/version).

2. Write down the information or print out the page.

The following table is intended to help you identify the causes of malfunctions and correct them where possible.

Malfunction	Possible causes	Solution
No image transmission to remote location.	Defective camera.	Connect a local monitor to the camera and check the camera function.
	Faulty cable connections.	Check all cables, plugs, contacts and connections.
No connection established, no image transmission.	The unit's configuration.	Check all configuration parameters.
	Faulty installation.	Check all cables, plugs, contacts and connections.
	Wrong IP address.	Check the IP addresses (terminal program).
	Faulty data transmission within the LAN.	Check the data transmission with ping.
	The maximum number of connections has been reached.	Wait until there is a free connection and call the transmitter again.



<b>Malfunction</b>	<b>Possible causes</b>	<b>Solution</b>
The unit does not report an alarm.	Alarm source is not selected.	Select possible alarm sources on the <b>Alarm sources configuration page</b> .
	No alarm response specified.	Specify the desired alarm response on the <b>Alarm connections configuration page</b> , if necessary change the IP address.
The unit is not operational after firmware upload.	Power failure during programming by the update file.	Have the unit checked by Customer Service and replace if necessary.
	Incorrect update file.	Enter the IP address followed by / main.htm in your web browser and repeat the upload.
No LUNs are displayed after connecting to the iSCSI server.	iSCSI server configuration has incorrect LUN mapping.	Check iSCSI server configuration and reconnect.
LUN FAIL is displayed under a node after connecting to the iSCSI server.	The LUN list could not be accessed because it was assigned to the wrong network interface.	Check iSCSI server configuration and reconnect.
LUN mapping not possible.	The iSCSI system does not support the use of initiator identification.	Delete the identity on the iSCSI-parameter configuration page.

## 12 Specifications

Type number	NWC-0495-10P	NWC-0495-20P
Standard	PAL	NTSC
Active pixels	752x582	768x492
Rated supply voltage	24 VAC or 12 VDC or Power-over-Ethernet (IEEE 802.3af) 12-28 VAC (50/60 Hz) 11-36 VDC	
Min illumination	< 0.4 lux < 0.15 lux (in monochrome mode)	
Imager	Interline CCD	
Resolution	540 TVL (BNC)	
SNR	> 50 dB	
Video output	1 Vpp, 75 Ohm	
Synchronization	Internal or Line Lock selectable	
Shutter	AES (1/60 (1/50) to 1/100000), Flickerless, Fixed selectable	
Day/Night	Color, Mono, Auto	
Sens Up	Adjustable from OFF to 10x	
Auto black	On, Off selectable (maximum level selectable up to 28dB)	
AGC	AGC on or off (0 dB) selectable	
XF-DYN	Automatic dynamic range enhancement level selectable	
DNR	Automatic noise filtering ON/OFF selectable	
Contour	Sharpness enhancement level selectable	
BLC	BLC On or Off selectable, with programmable area	
White balance	Automatic 2500 - 9000K (with AWB hold mode and manual mode)	
Color saturation	Adjustable from monochrome (0%) to 133% color	
Lens Mount	CS compatible, C-mount compatible with supplied adapter ring	
ALC lens	Video or DC iris auto detect	
Power consumption	< 8 W	
Dimensions	59 x 67 x 122 mm (2.28 x 2.6 x 4.8 inch) without lens (HxWxL)	
Weight	450g (0.99 lbs) without lens	
Tripod Mount	Bottom (isolated) and Top ¼" 20 UNC	
Operating temperature	0° to 40° C (32° to 104° F)	
Controls	OSD with softkey operation	
LAN interface	1 × Ethernet 10/100 Base-T, automatic adaptation, half/full duplex, RJ-45	
Video encoding protocols	MPEG-4, JPEG	
Video data rate	9,600 KBit/s ... 10 MBit/s	

Image resolutions (PAL/NTSC)	704 × 576/480 pixels (D1/4CIF) 464 × 576/480 pixels (2/3 D1) 704 × 288/240 pixels (2CIF) 704 × 288/240 pixels (1/2 D1) 352 × 288/240 pixels (CIF) 176 × 144/120 pixels (QCIF)
Total delay	120 ms (PAL/NTSC, MPEG-4, no network delay)
Image refresh rate	1 ... 50/60 fields/s adjustable (PAL/NTSC)
Field/image-based coding	
Network protocols	TCP, UDP, IP, HTTP, IGMP V2, ICMP, ARP

## 12.1 Dimensions (mm/inch)

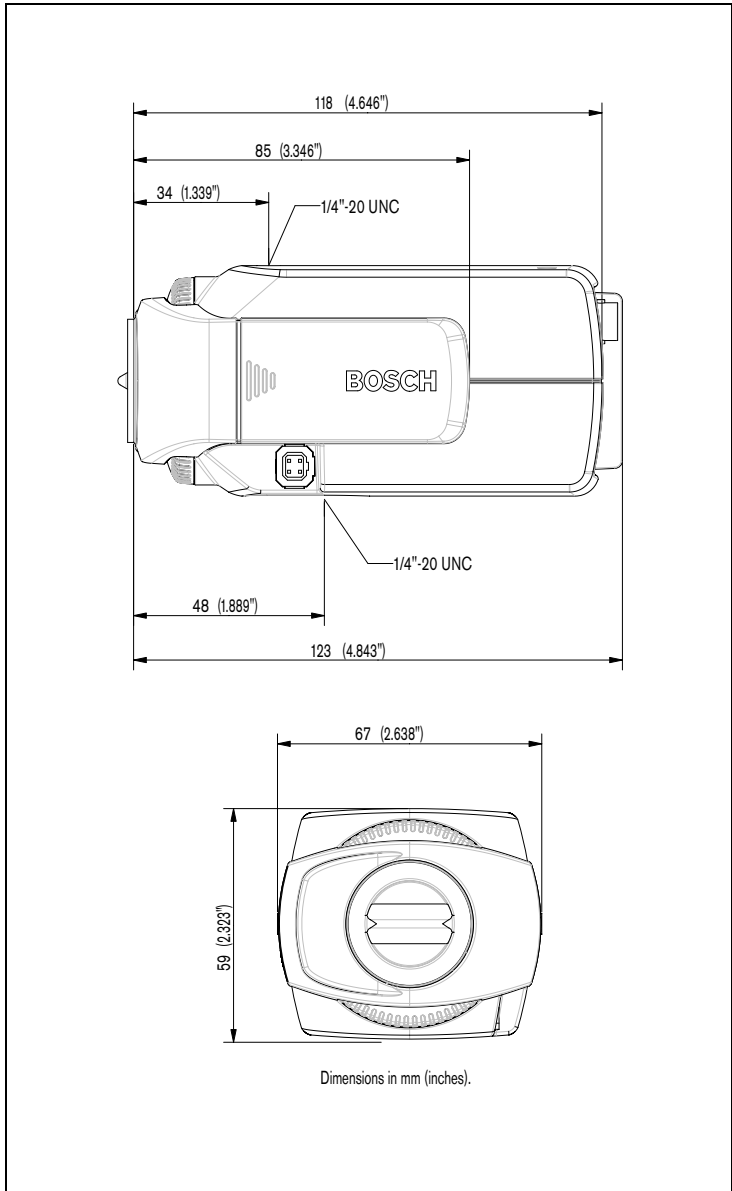

## 12.2 Accessories

### 12.2.1 Recommended lenses

LTC 3764/20 Varifocal Lens

- 1/2-inch, 4 -12 mm, DC-iris, C-mount, F/1.2-360, 4 pin

LTC 3774/30 Varifocal Lens

- 1/2-inch, 10 - 40 mm, DC-iris, C-mount, F/1.4-360, 4-pin

LTC 3783/50 Zoom Lens

- 1/2-inch, 8.5 - 85 mm, video-iris, C-mount F/1.6-360, 4-pin

LTC 3793/50 Zoom Lens

- 1/2-inch, 8 - 144 mm, video-iris, C-mount, F/1.6-360, 4-pin

LTC 3664/40 Varifocal Lens

- 1/3-inch, 2.8 - 11 mm, DC-iris, CS-mount F/1.4-360, 4-pin

LTC 3664/30 Varifocal Lens

- 1/3-inch, 3.0 - 8 mm, DC-iris, CS-mount F/1.0-360, 4-pin

### 12.2.2 Power transformers

TC 120PS Power Supply Unit

- 110-120 VAC/15 VDC, 50/60 Hz, 300mA

TC 220PS Power Supply Unit

- 230 VAC/15 VDC, 50 Hz, 10 VA

## 13 Glossary

Brief explanations of some of the terms and abbreviations found in this user guide are given below.

10/100 Base-T 802.1x	IEEE 802.3 specification for 10 or 100 MBit/s Ethernet The IEEE standard, 802.1x, provides a general method of access control and authorization for IEEE 802-based networks. An authenticator provides authentication by accessing an authentication server (see RADIUS server) to check connection requests, and grants or refuses access to the available services (LAN, VLAN, WLAN).
ARP	Address Resolution Protocol: a protocol for mapping MAC and IP addresses
Baud	Unit of measure for the speed of data transmission
Bit/s	Bits per second, the actual data rate
CIF	Common Intermediate Format, video format with 352 x 288/240 pixels
DNS	Domain Name Service
DHCP	Dynamic Host Configuration Protocol allows a network device to receive a dynamically allocated IP address and other network parameters from a server in a network.
FTP	File Transfer Protocol
Full duplex	Simultaneous data transmission in both directions (sending and receiving)
Gateway	Access point to another LAN (subnet)
GOP	Group of pictures
HTTPS	Hypertext Transfer Protocol Secure provides secure transfer of data between web sever and web browser.
HTTP	Hypertext Transfer Protocol
ICMP	Internet Control Message Protocol
ID	Identification: a machine-readable character sequence
IEEE	Institute of Electrical and Electronics Engineers
IGMP	Internet Group Management Protocol
Internet Protocol	The main protocol used on the Internet, normally in conjunction with the Transfer Control Protocol (TCP): TCP/IP

IP	See Internet Protocol
IP address	A 4-byte number uniquely defining each device on the Internet. It is usually written in dotted decimal notation with full stops separating the bytes, for example "209.130.2.193".
ISDN	Integrated Services Digital Network
JPEG	An encoding process for still images (Joint Photographic Experts Group)
kBit/s	Kilobits per second, the actual data rate
LAN	See Local area network
Local area network	A communications network serving users within a limited geographical area, such as a building or a university campus. It is controlled by a network operating system and uses a transfer protocol.
MAC	Media Access Control
MPEG-4	Further development of MPEG-2, designed for transmission of audiovisual data at very low transfer rates (for example via the Internet).
Net mask	A mask that explains which part of an IP address is the network address and which part comprises the host address. It is usually written in dotted decimal notation with full stops separating the bytes, for example "255.255.255.192".
NTP	Network Time Protocol is a standard for synchronizing the system clocks in computers in packet switching networks. NTP uses the stateless protocol, UDP. NTP was designed to provide dependable time synchronization in networks with variable latency (ping times).
Parameters	Values used for configuration
QCIF	Quarter CIF, a video format with 176 × 144/120 pixels
RADIUS server	RADIUS server Remote Authentication Dial-in User Service is a client-server protocol for authentication, authorization, and accounting of users in dial-in connections for computer networks. RADIUS is the de-facto standard for centralized authentication of dial-ins for modems, ISDN, VPN, wireless LAN (see 802.1x), and DSL.
RFC 868	A protocol for synchronizing computer clocks over the Internet

---

RS232/RS422/RS485	Standards for serial data transmission
RTP	Realtime Transport Protocol; A transmission protocol for real-time video and audio
SNTP	Simple Network Time Protocol is a simplified version of NTP (see NTP).
SSL	Secure Sockets Layer is an encryption protocol for data transmission in IP-based networks.
Subnet mask	See Net mask
TCP	Transfer Control Protocol
Telnet	Login protocol with which users can log on to a remote computer (host) on the Internet
TSL	TSL Transport Layer Security versions 1.0 and 1.1 are standardized enhancement of the SSL 3.0 protocol (see SSL).
TTL	Time-To-Live; life cycle of a data packet in station transfers
UDP	User Datagram Protocol
URL	Uniform Resource Locator
UTP	Unshielded Twisted Pair
WAN	See wide area network
Wide area network	A long distance link used to extend or connect remotely located local area networks







**Bosch Security Systems**

Robert-Koch-Straße 100

D-85521 Ottobrunn

Germany

Telefon 089 6290-0

Fax 089 6290-1020

**[www.boschsecuritysystems.com](http://www.boschsecuritysystems.com)**

© Bosch Security Systems, 2007

## Free Manuals Download Website

<http://myh66.com>

<http://usermanuals.us>

<http://www.somanuals.com>

<http://www.4manuals.cc>

<http://www.manual-lib.com>

<http://www.404manual.com>

<http://www.luxmanual.com>

<http://aubethermostatmanual.com>

Golf course search by state

<http://golfingnear.com>

Email search by domain

<http://emailbydomain.com>

Auto manuals search

<http://auto.somanuals.com>

TV manuals search

<http://tv.somanuals.com>