

Use & Care Guide
Manual de uso y cuidada
English / Español

Models / Modelos: 790.8037*, 790.8338*

Kenmore Elite[®]

Microwave Hood Combination

COMBINACION MICROONDAS CAMPANA

* = color number, número de color*

P/N 316495110

Sears Brands Management Corporation
Hoffman Estates, IL 60179 U.S.A.

www.kenmore.com



Table of Contents

Warranty	2	Setting Two-Stage Cooking	18
Master Protection Agreement.....	3	Microwave Power Levels	19
Microwave Oven Safety	4	Using Auto Defrost	20
Getting to Know Your Microwave Oven	7	Auto Defrost Table	21-22
How Your Microwave Oven Works	7	Defrosting Tips	23
Radio Interference	7	Sensor Operating Instructions	24
Cooking Comparison Guide.....	7	Using Sensor Cook	24
For the Best Cooking Results	8	Using Sensor Reheat	24
Cookware Guide	8	Sensor Cook Table	25
How To Use Accessories.....	9	Sensor Reheat Table	25
Operating Safety Precautions	9	Using Quick Touch	26
Electrical Connection	9	Setting Melt/Soften	27
Specifications.....	10	Tips For Convection Cooking	28
Microwave Oven Features	10	Convection Keep Warm	28
Control Panel Features	11	Convection Bake Roast	28-29
Microwave Cooking Tips	12-13	Convection Baking Guidelines	30-31
Wire Shelf Use	13	Meat Roasting Guidelines For Convection Cooking..	32
Aluminum Foil Containers.....	13	Tips For Combination Cooking.....	33
Using Your Microwave Oven	14	Micro + Conv Combicook	33
Clock & Settings	14-16	Combination Roast Cooking Guide	34
Setting Kitchen Timer	16	Combination Bake Cooking Guide	34
Using Vent Fan	17	Favorite Recipes	35-36
Using Vent Delay	17	Caring for Your Microwave Oven	37
Using Cooktop Light	17	Caring for the Filters	38
Setting Timed Cook	17	Replacing the Cooktop and Oven Lights	39
Interrupting Cooking	17	Questions and Answers	40
Using One Touch Start	17	Troubleshooting	41
Using Add 30 Sec	18	Sears Service	42
Setting Timed Cooking with Power Level.....	18		

KENMORE ELITE LIMITED WARRANTY

WITH PROOF OF SALE, the following warranty coverage applies when this appliance is correctly installed, operated and maintained according to all supplied instructions.

FOR ONE YEAR from the date of sale this appliance is warranted against defects in material or workmanship. A defective appliance will receive free repair or replacement at option of seller.

FOR FIVE YEARS from the date of sale, the magnetron of this appliance is warranted against defects in material or workmanship. Safety regulations require that the magnetron be installed by Sears. If the magnetron is defective within the first year, a new one will be supplied and installed at no charge. If the magnetron is defective after the first year, a new one will be supplied but not installed at no charge. You are responsible for the labor cost of magnetron installation after the first year from the date of sale.

For warranty coverage details to obtain free repair or replacement, visit the web page: www.kenmore.com/warranty

All warranty coverage applies for only 90 DAYS from the sale date in the United States, and is void in Canada, if this appliance is ever used for other than private household purposes.

This warranty covers ONLY defects in material and workmanship, and will NOT pay for:

1. Expendable items that can wear out from normal use, including but not limited to filters, belts, bags or screw-in base light bulbs.
2. A service technician to clean or maintain this appliance, or to instruct the user in correct appliance installation, operation and maintenance.
3. Service calls to correct appliance installation not performed by Sears authorized service agents, or to repair problems with house fuses, circuit breakers, house wiring, and plumbing or gas supply systems resulting from such installation.
4. Damage to or failure of this appliance resulting from installation not performed by Sears authorized service agents, including installation that was not in accord with electrical, gas or plumbing codes.
5. Damage to or failure of this appliance, including discoloration or surface rust, if it is not correctly operated and maintained according to all supplied instructions.
6. Damage to or failure of this appliance, including discoloration or surface rust, resulting from accident, alteration, abuse, misuse or use for other than its intended purpose.
7. Damage to or failure of this appliance, including discoloration or surface rust, caused by the use of detergents, cleaners, chemicals or utensils other than those recommended in all instructions supplied with the product.
8. Damage to or failure of parts or systems resulting from unauthorized modifications made to this appliance.
9. Service to an appliance if the model and serial plate is missing, altered, or cannot easily be determined to have the appropriate certification logo.

Disclaimer of implied warranties; limitation of remedies

Customer's sole and exclusive remedy under this limited warranty shall be product repair or replacement as provided herein. Implied warranties, including warranties of merchantability or fitness for a particular purpose, are limited to one year on the appliance and five years on the magnetron, or the shortest period allowed by law. Seller shall not be liable for incidental or consequential damages. Some states and provinces do not allow the exclusion or limitation of incidental or consequential damages, or limitation on the duration of implied warranties of merchantability or fitness, so these exclusions or limitations may not apply to you.

This warranty applies only while this appliance is used in the United States or Canada*.

This warranty gives you specific legal rights, and you may also have other rights which vary from state to state.

Sears Brands Management Corporation, Hoffman Estates, IL 60179
Sears Canada Inc., Toronto, Ontario, Canada M5B 2C3

Microwave Oven Safety

Your safety and the safety of others is very important.

We have provided many important safety messages in this manual and on your microwave oven. Always read and obey all safety messages.



This is the safety alert symbol.

This symbol alerts you to hazards that can kill or hurt you and others. All safety messages will be preceded by the safety alert symbol and the word "DANGER" or "WARNING." These words mean:



DANGER

You **will** be killed or seriously injured if you do not follow instructions immediately.



WARNING

You **can** be killed or seriously injured if you do not follow instructions.

All safety messages will identify the hazard, tell you how to reduce the chance of injury, and tell you what can happen if the instructions are not followed.

IMPORTANT SAFETY INSTRUCTIONS

When using electrical appliances, basic safety precautions should be followed, including the following:

⚠ WARNING: To reduce the risk of burns, electric shock, fire, injury to persons, or exposure to excessive microwave energy:

- Read all instructions before using the microwave oven.
- Read and follow the specific "PRECAUTIONS TO AVOID POSSIBLE EXPOSURE TO EXCESSIVE MICROWAVE ENERGY" found on page 6.
- The microwave oven must be grounded. Connect only to properly grounded outlet. See "GROUNDING INSTRUCTIONS" found on page 6.
- Install or locate the microwave oven only in accordance with the provided installation instructions.
- Some products such as whole eggs in the shell and sealed containers, such as closed jars, can explode and should not be heated in the microwave oven.
- Use the microwave oven only for its intended use as described in this manual.
- Do not use corrosive chemicals or vapors in the microwave oven. This type of oven is specifically designed to heat, cook, or dry food. It is not designed for industrial or laboratory use.
- As with any appliance, close supervision is necessary when used by children.
- Do not operate the microwave oven if it has a damaged cord or plug, if it is not working properly, or if it has been damaged or dropped.

SAVE THESE INSTRUCTIONS

IMPORTANT SAFETY INSTRUCTIONS

- The microwave oven should be serviced only by qualified service personnel. Call an authorized service company for examination, repair, or adjustment.
- See door surface cleaning instructions in the "Caring for Your Microwave Oven" section.
- To reduce the risk of fire in the oven cavity:
 - Do not overcook food. Carefully attend to the microwave oven when paper, plastic, or other combustible materials are placed inside the oven to facilitate cooking.
 - Remove wire twist-ties from paper or plastic bags before placing bags in oven.
 - If materials inside the oven ignite, keep oven door closed, turn oven off, and disconnect the power cord, or shut off power at the fuse or circuit breaker panel.
 - Do not use the cavity for storage purposes. Do not leave paper products, cooking utensils, or food in the cavity when not in use.
- This Microwave Oven is suitable for use above both gas and electric cooking equipment.
- This Microwave Oven is intended to be used above ranges with a maximum width of 36 inches (91 cm).
- Clean Ventilating Hoods frequently - grease should not accumulate on hood or filter.
- When flaming foods under the hood, turn the fan on.
- Use care when cleaning the vent-hood filter. Corrosive cleaning agents, such as lye-based oven cleaners, may damage the filter.
- Oversized foods or oversized metal utensils should not be inserted in the microwave oven, as they may create a fire or risk of electric shock.
- Do not clean with metal scouring pads. Pieces can break off the pad and touch electrical parts, causing a risk of electric shock.
- Do not store anything directly on top of the microwave oven when the microwave oven is in operation.
- Do not cover or block any openings on the microwave oven.
- Do not store this microwave oven outdoors.
- Do not use the microwave oven near water—for example, near a kitchen sink, in a wet basement, near a swimming pool, or similar location.
- Do not immerse cord or plug in water.
- Keep cord away from heated surfaces.
- Do not let cord hang over edge of table or counter.
- Do not mount over a sink.
- Do not cover racks or any other part of the oven with metal foil. Doing so will cause overheating of the oven.
- Liquids such as water, coffee, or tea are able to overheat beyond the boiling point without appearing to be boiling due to surface tension of the liquid. Visible bubbling or boiling when the container is removed from the microwave oven is not always present. This could result in very hot liquids suddenly boiling over when a spoon or other utensil is inserted into the liquid.
To reduce the risk of injury to persons:
 - 1) Do not overheat the liquid.
 - 2) Stir the liquid before and halfway through heating it.
 - 3) Do not use straight-sided containers with narrow necks.
 - 4) After heating, allow the container to stand in the microwave oven for a short time before removing the container.
 - 5) Use extreme caution when inserting a spoon or other utensil into the container.

SAVE THESE INSTRUCTIONS

PRECAUTIONS TO AVOID POSSIBLE EXPOSURE TO EXCESSIVE MICROWAVE ENERGY

(a) Do not attempt to operate this oven with the door open. Doing so can result in harmful exposure to microwave energy. It is important not to defeat or tamper with the safety interlocks.

(b) Do not place any object between the oven front face and the door, or allow soil or cleaner residue to accumulate on sealing surfaces.

(c) Do not operate the oven if it is damaged. It is particularly important that the oven door closes properly and that there is no damage to the:

- (1) Door (bent)
- (2) Hinges and latches (broken or loosened)
- (3) Door seals and sealing surfaces

(d) The oven should not be adjusted or repaired by anyone except for a properly qualified service technician.

ELECTRICAL REQUIREMENTS

Observe all governing codes and ordinances. A 120-Volt, 60-Hz, AC-only, 15 or 20-amp fused electrical supply is required. A time delay fuse is recommended. It is recommended that a separate circuit, serving only this appliance, is provided.



DANGER



Electrical Shock Hazard
Plug into a grounded 3 prong outlet. Do not remove ground prong. Do not use an adapter. Do not use an extension cord. Failure to follow these instructions can result in death, fire or electrical shock.

GROUNDING INSTRUCTIONS

• For all cord connected appliances:
The microwave oven must be grounded. In the event of an electrical short circuit, grounding reduces the risk of electric shock by providing an escape wire for the electric current. The microwave oven is equipped with a cord having a grounding wire with a grounding plug. The plug must be plugged into an outlet that is properly installed and grounded.

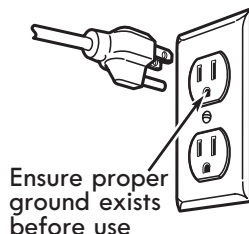

Ensure proper ground exists before use

WARNING: Improper grounding can result in a risk of electric shock. Consult a qualified electrician or service technician if you do not understand the grounding instructions, or if you wonder whether the appliance is properly grounded.

Do not use an extension cord. If the power supply cord is too short, have a qualified electrician or service technician install an outlet near the microwave oven.

• For a permanently connected appliance:
This appliance has a short power supply cord to reduce the risk of anyone tripping over or becoming entangled in the cord. The microwave oven must be connected to a grounded, metallic, permanent wiring system, or an equipment grounding conductor should be run with the circuit conductors and connected to the equipment grounding terminal or lead on the microwave oven.

SAVE THESE INSTRUCTIONS

Getting to Know Your Microwave Oven

This section discusses the concepts behind microwave cooking. It also shows the basics that you need to know in order to operate your microwave oven. Please read this information before using your oven.

HOW YOUR MICROWAVE OVEN WORKS

Microwave ovens are safe. Microwave energy is not hot. It causes food to make its own heat, and it is this heat that cooks the food.

Microwaves are like TV waves, radio waves, or light waves. You cannot see them, but you can see the results of what they do.

A magnetron in the microwave oven produces microwaves. The microwaves move into the oven where they contact food as it turns on the turntable.

The glass turntable of your microwave oven lets microwaves pass through. The microwaves then bounce off a metal floor, back through the glass turntable, and are absorbed by the food.

Microwaves pass through most glass, paper, and plastics without heating them, so food absorbs the energy. Microwaves bounce off metal containers so food does not absorb the energy.

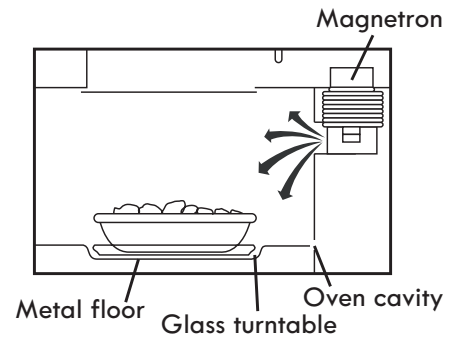

RADIO INTERFERENCE

Using your microwave oven may cause interference to your radio, TV, or similar equipment. When there is interference, you can reduce it or remove it by:

- **Cleaning** the door and sealing surfaces of the oven.
- **Adjusting** the receiving antenna of the radio or television.
- **Moving** the receiver away from the microwave oven.
- **Plugging** the microwave oven into a different outlet so that the microwave oven and receiver are on different branch circuits.

COOKING COMPARISON GUIDE

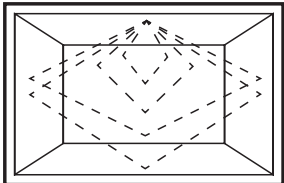
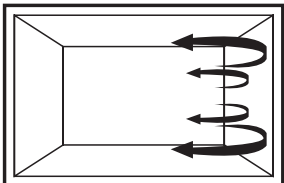
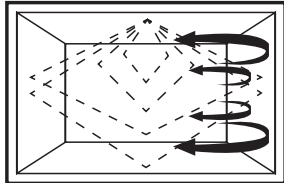
	MICROWAVE	CONVECTION	COMBINATION
COOKING METHOD	 <p>Microwave energy is distributed evenly throughout the oven for fast, thorough cooking of food.</p>	 <p>Hot air circulates around food to produce browned exteriors and sealed-in juices.</p>	 <p>Microwave energy and convection heat combine to shorten the cooking time of regular ovens, while browning and sealing in juices.</p>
HEAT SOURCE	Microwave energy.	Circulating heated air.	Microwave energy and circulating heated air.
BENEFITS	<ul style="list-style-type: none"> • Fast, high efficiency cooking. • Oven and surroundings do not get hot. • Easy clean-up. 	<ul style="list-style-type: none"> • Aids in browning and seals in flavor. • Cooks some foods faster than regular ovens. 	<ul style="list-style-type: none"> • Shortened cooking time from microwave energy. • Browning and crisping from convection heat.

FOR THE BEST COOKING RESULTS

- **Always cook food** for the shortest cooking time recommended. Check to see how the food is cooking. If needed, touch Add 30 Sec while the oven is operating, or after the cooking cycle is over (see the "Add 30 Sec" section).
- **Stir, turn over, or rearrange** the food being cooked about halfway through the cooking time for all recipes. This will help ensure that the food is evenly cooked.
- **If you do not have a cover for a dish**, use wax paper, or microwave-approved paper towels or plastic wrap. Remember to turn back a corner of the plastic wrap to vent steam during cooking.
- **The wire shelf and metal platform rack** are used for cooking certain items and should be removed from the microwave oven when not needed. Do not store The wire shelf or metal platform rack in the microwave oven.

COOKWARE GUIDE

Microwave Cooking

Do not use the wire platform rack for normal microwave only cooking

Most heat-resistant, non-metallic cookware is safe for use in your microwave oven. However, to test cookware before using, follow these steps:"

1. Place the empty cookware in the microwave oven.
2. Measure 1 cup (250ml) of water in a glass measuring cup and place it in the oven beside the cookware.
3. Microwave on 100% power for 1 minute. If the dish is warm, it should not be used for microwave cooking.

Convection Cooking

- Metal Pans are recommended for all types of baked products, but especially where browning or crusting is important.
- Dark or dull finish metal pans are best for breads and pies because they absorb heat and produce a crisper crust.
- Shiny aluminum pans are better for cakes, cookies, or muffins because these pans reflect heat and help produce a light, tender crust.
- Glass or glass-ceramic casserole or baking dishes are best suited for egg and cheese recipes due to the cleanability of glass.

Combination Cooking

- Glass or glass-ceramic baking containers are recommended. Be sure not to use items with metal trim as it may cause arcing (sparking) with oven wall or wire shelf , damaging the cookware, the wire shelf or the oven.
- Heat-resisant plastic microwave cookware (safe to 450 °F) may be used, but is not recommended for foods that require crusting or all-around browning, because plastic is a poor conductor of heat.

COOKWARE	MICROWAVE	CONVECTION	COMBINATION
Heat-Resistant Glass, Ceramic Glass	Yes	Yes	Yes
Ceramics, China	Yes (Do not use china with gold or silver trim.)	Yes	Yes
Metal Cookware	No	Yes	No
Non Heat-Resistant Glass	No	No	No
Microwave-Safe Plastic	Yes	No	Yes*
Plastic Wrap, Wax Paper	Yes	No	No
Paper Products	Yes	No	No
Straw, Wicker, and Wood	Yes	No	No

* Use only microwave cookware that is safe to 450° F

HOW TO USE ACCESSORIES





Glass Turntable



Metal Platform Rack

- : Possible to use
 ⊙ : Recommended method
 X : Do not use

	MICROWAVE	CONVECTION	COMBINATION
	⊙	○	○
	X	⊙	⊙

Notes: Do not operate the oven when it is empty except preheating.

OPERATING SAFETY PRECAUTIONS

- **Never** lean on or allow a child to swing on the door when it is open.
- **Use hot pads to handle food containers.** Microwave energy does not heat containers, but the heat from the food can make the container hot.
- **Do not** use newspaper or other printed paper in the oven.
- **Do not** dry flowers, fruit, herbs, wood, paper, gourds, or clothes in the oven.
- **Do not** start a microwave oven when it is empty. This may shorten the life-span of the oven. To practice programming, put a container of water in the oven before starting.
- **Do not** try to melt paraffin wax in the oven. Paraffin wax will not melt in a microwave oven because it allows microwaves to pass through it.
- **Do not** operate the microwave oven unless the glass turntable is securely in place and can rotate freely. The turntable can rotate in either direction. **Make sure** the turntable is correct-side up in the oven. **Handle your turntable with care** when removing it from the oven to avoid breaking it.
- **When using a browning dish**, the browning dish bottom must be at least 3/16 inch above the turntable. Follow the directions supplied with the browning dish.
- **Never cook or reheat a whole egg inside the shell.** Steam buildup in whole eggs may cause them to burst, and possibly damage the oven. **Slice** hard-boiled eggs before heating. In rare cases, poached eggs have been known to explode. **Cover** poached eggs and **allow** a standing time of one minute before cutting into them.
- **For best results, stir any liquid several times during heating or reheating.** Liquids heated in certain containers (especially containers shaped like cylinders) may overheat. The liquid may splash during or after heating or when adding ingredients (coffee granules, tea bags, etc.). This can harm you or damage the microwave oven.
- **Microwaves** may not reach the center of a roast. The heat spreads from the outer to the center cooked areas, just as in regular oven cooking. This is one of the reasons for letting some foods (for example, roasts or baked potatoes) stand for a while after cooking, or for stirring some foods during the cooking time.
- **Do not deep fry in the oven.** Microwavable utensils are not suitable and it is difficult to maintain appropriate deep-frying temperatures.
- **Do not overcook potatoes.** At the end of the recommended cooking time, potatoes should be slightly firm because they will continue cooking during standing time. **After microwaving**, let potatoes stand for 5 minutes. They will finish cooking while standing.

ELECTRICAL CONNECTION

If your electric power line or outlet voltage is less than AC 110 volts, cooking times may be longer. Have a qualified electrician check your electrical system.

SPECIFICATIONS

AC Line Voltage	120V AC, 60 Hz
AC Power Required	1650W/14.0amps
Microwave Output Power	*1050 W
Overall Dimensions(WxHxD)	29 ⁷ / ₈ " X 17 ⁹ / ₁₆ " X 16 ¹ / ₁₆ "
Oven Cavity Dimensions(WxHxD)	21 ¹ / ₄ " X 9 ¹⁵ / ₁₆ " X 14 ²³ / ₃₂ "
Capacity of Oven Cavity	1.8 cu.ft

*IEC 60705 RATING STANDARD
Specifications subject to change without prior notice.

MICROWAVE OVEN FEATURES

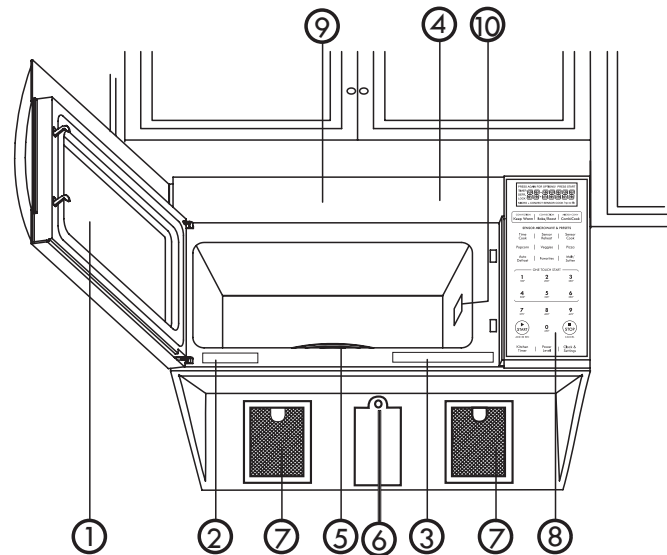

The microwave oven is designed to make your cooking experience as enjoyable and productive as possible. To get you up and running quickly, the following is a list of the oven's basic features:

- 1. Metal Shielded Window:** The shield prevents microwaves from escaping. It is designed as a screen to allow you to view food as it cooks.
- 2. Model and Serial Number Plate**
- 3. Cooking Guide label**

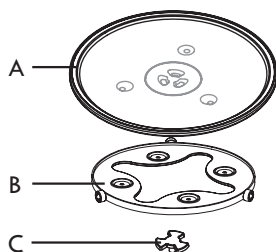

- A. Glass Turntable
B. Support
C. Hub

4. Vent Top

5. Glass Turntable:

The turntable reverses rotation each time the microwave oven door is opened and closed. This helps cook food evenly. Do not operate the microwave oven without the turntable in place.

To Install:

1. Place the support on the oven cavity bottom.
2. Place the glass turntable on the support. Fit the raised, curved lines in the center of the turntable bottom between the three spokes of the hub. The rollers on the support should fit inside the turntable bottom ridge.

6. Cooktop Light

7. Grease Filters: See "Caring for the Filters" section.

8. Control Panel: Touch the pads on this panel to perform all functions.

9. Charcoal Filter: (behind Vent Top):
See "Caring for the Filters" section.

NOTE: Not all models come with a charcoal filter.

10. Waveguide Cover: DO NOT REMOVE.

CONTROL PANEL FEATURES

Your microwave oven control panel lets you select the desired cooking function quickly and easily. All you have to do is touch the necessary Command Pad. The following is a list of all the Command and Number Pads located on the control panel. **For more information on these features, see the “Using Your Microwave Oven” section.**

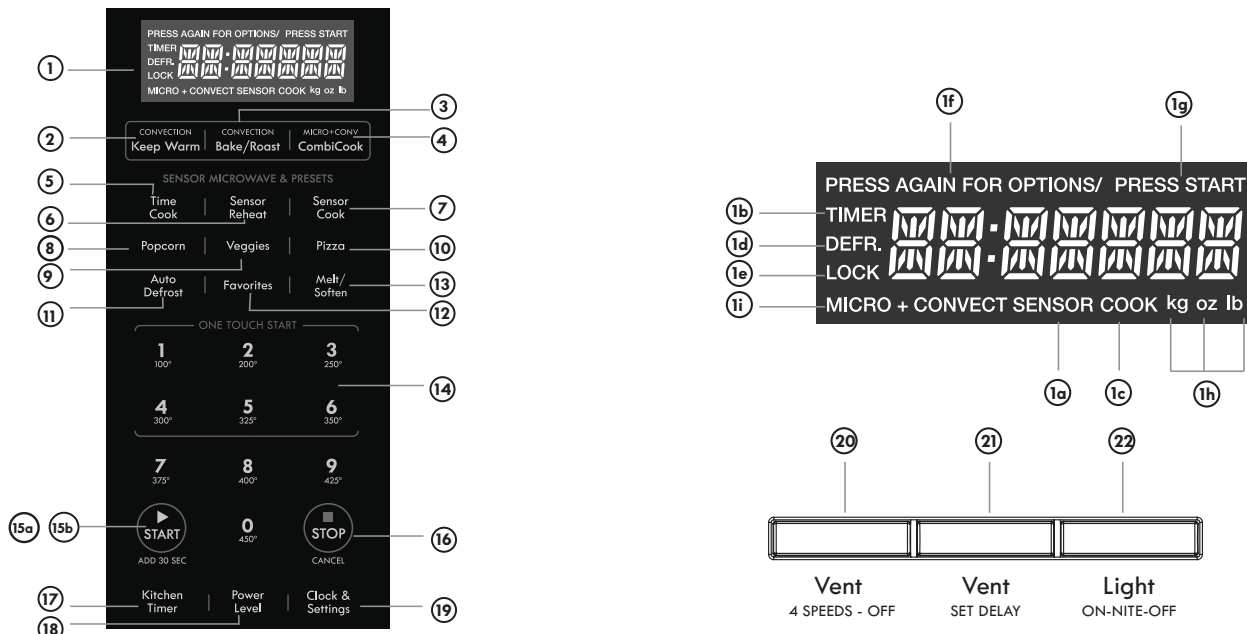

- 1. Display:** The display includes a clock and indicators that show the time of day, cooking time settings, cook powers, CombiCook, sensor, quantities, weights and cooking functions selected.
- 1a. SENSOR:** Icon displayed when using sensor cook.
- 1b. TIMER:** Icon displayed when timer is being set or running.
- 1c. COOK:** Icon displayed when starting microwave cooking.
- 1d. DEFR:** Icon displayed when defrosting food
- 1e. LOCK:** Icon displayed in control lock.
- 1f. PRESS AGAIN FOR OPTIONS:** Icon displayed when additional options are available.
- 1g. PRESS START:** Icon displayed when a valid function can be started.
- 1h. kg, oz, lb:** Icon displayed when choosing the weight.
- 1i. MICRO+CONVECT:** Icon displayed when using combicook.
- 2. Convection Keep Warm:** Touch this pad to keep food warm.
- 3. Convection Bake/Roast:** Touch this pad when setting a convection bake or roast.
- 4. Micro+ Conv CombiCook:** Touch this pad when setting a convection microwave and convection cook.
- 5. Time Cook:** Touch this pad, followed by Number Pads, to set a cooking time.
- 6. Sensor Reheat:** Touch this pad to reheat microwavable foods without entering a cook time or power.
- 7. Sensor Cook:** Touch this pad to cook microwavable foods without entering a cook time or power.
- 8. Popcorn:** Touch this pad to pop one of three bag sizes of popcorn without entering a cook time or power. Remove metal shelf and metal platform rack before cooking popcorn.
- 9. Veggies:** Touch this pad to cook fresh or frozen vegetables without entering a cook time or power.
- 10. Pizza:** Touch this pad to reheat one to four slices of pizza without entering a cook time or power.
- 11. Auto Defrost:** Touch this pad, followed by Number Pads, to thaw frozen meat, poultry, fish by weight
- 12. Favorites:** Touch this pad to select one of several preprogrammed items.
- 13. Melt/Soften:** Touch this pad to melt or soften selected items.
- 14. Number Pads:** Touch number pads to enter time, cook power, quantity, weight, or food category.
- 15a. START:** Touch this pad to start or restart a function.
- 15b. Add 30 Sec.:** Touch this pad to cook for 30 seconds at 100% cook power, or to add extra time to your current cooking cycle.
- 16. STOP:** Touch this pad to erase an incorrect command, cancel a program during cooking, or to clear the Display.
- 17. Kitchen Timer:** Touch this pad to set the kitchen timer.
- 18. Power level:** Touch this pad after the cook time has been set, followed by a Number Pad to set the amount of microwave energy released to cook the food. The higher the number, the higher the microwave power or "cooking speed."
- 19. Clock & Settings:** Touch this pad to enter the correct time of day or set options.
- 20. Vent 4 Speeds-off:** Touch this pad to choose one of four speeds.
- 21. Vent set Delay:** Touch this pad to set the delay before the vent turns off.
- 22. Light On/Nite/Off:** Touch this pad to turn the light on high, night (low) or off.

Microwave Cooking Tips

Amount of Food

- **If you increase or decrease** the amount of food you prepare, the time it takes to cook that food will also change. For example, if you double a recipe, add a little more than half the original cooking time. Check for readiness and, if necessary, add more time in small increments.

Starting Temperature of Food

- **The lower the temperature** of the food being put into the microwave oven, the longer it takes to cook. Food at room temperature will reheat quicker than food at refrigerator temperature.

Composition of Food

- **Food with a lot of fat and sugar** will heat faster than food containing a lot of water. Fat and sugar will also reach a higher temperature than water in the cooking process.
- **The more dense the food**, the longer it takes to heat. "Very dense" food, like meat, takes longer to heat than lighter, more porous food, like sponge cakes.

Size and Shape

- **Smaller pieces of food** will cook faster than larger pieces. Also, same shaped pieces cook more evenly than differently shaped pieces.
- **With foods that have different thicknesses**, the thinner parts will cook faster than the thicker parts. Place the thinner parts of chicken wings and legs in the center of the dish.

Stirring and Turning Foods

- **Stirring and turning foods** spreads heat quickly to the center of the dish and avoids overcooking at the outer edges of the food.

Covering Food

- **Cover food to** reduce splattering, shorten cooking times, and keep food moist.

You can use any covering that lets microwaves pass through. See "Getting to Know Your Microwave Oven" for materials that microwaves will pass through.

Releasing Pressure in Foods

- **Several foods** (for example: baked potatoes, sausages, egg yolks, and some fruits) are tightly covered by a skin or membrane. Steam can build up under the membrane during cooking, causing the food to burst. To relieve the pressure and to prevent bursting, pierce these foods before cooking with a fork, cocktail pick, or toothpick.

Using Standing Time

- **Always allow food to stand**, either in or out of the oven, after cooking power stops. Standing time after defrosting and cooking allows the temperature to evenly spread throughout the food, improving the cooking results. For inside oven standing time, you can program a "0" power second stage of the cooking cycle. See Two-Stage Cooking.
- **The length of the standing time** depends on how much food you are cooking and how dense it is. Sometimes it can be as short as the time it takes to remove the food from the oven and take it to the serving table. However, with a larger, denser food item, the standing time may be as long as 10 minutes.

Arranging Food

For best results, place food evenly on the plate. You can do this in several ways:

- **If you are cooking several items of the same food**, such as baked potatoes, place them in a ring pattern for uniform cooking.
- **When cooking foods of uneven shapes or thickness**, such as chicken breasts, place the smaller or thinner area of the food towards the center of the dish where it will be heated last.
- **Layer thin slices of meat** on top of each other.
- **When you cook or reheat whole fish**, score the skin - this prevents cracking.
- **Do not** let food or a container touch the top or sides of the oven. This will prevent possible arcing. Arcing is a spark that can cause damage to the oven interior.

Cooking you should not do in your microwave oven

- **Do not** put canned foods in the oven. Closed glass jars may explode, resulting in damage to the oven.
- **Do not** use the microwave oven to sterilize objects (baby bottles, etc.). It is difficult to keep the oven at the high temperature needed for sterilization.

Wire Shelf Use

- Use the wire shelf **ONLY** when cooking on two levels. Place equal amounts of food **ON AND BELOW** the shelf. The amount of food placed on the shelf and turntable must be approximately the same to balance out the cooking energy.
- Place the four corners of the wire shelf securely into the four plastic rack supports in the oven cavity. The wire shelf **MUST NOT** contact the metal walls or back of the oven cavity. Metal to metal contact can cause **arcing**, which is a discharge of electrical current that can damage the oven.
- Clean plastic rack supports often (see Cleaning section). Soil buildup on supports may also lead to arcing and cause damage to the oven or supports.

CAUTION

- **Do not** use the wire shelf when popping microwave popcorn or the metal platform rack can cause damage to your microwave oven.
- **Do not** use the oven with the wire shelf on the microwave floor as this could damage the oven.
- **Do not** handle the wire shelf without using pot holders as the wire shelf may be hot.
- **Do not** use the wire shelf unless cooking or heating more than one food container at the same time.
- **Do not** store the wire shelf in the microwave oven as damage to the oven could result if someone accidentally turns on the oven.
- **Do not** attempt to use any other wire shelf besides the one supplied with this oven. The supplied shelf is designed specifically for this oven and using any other shelf can damage to the oven.
- **Do not** cook food directly on the wire shelf. Always place food in a microwave-safe container.

Arcing

Arcing is the microwave term for sparks in the microwave oven. If you see arcing, press the Stop/Cancel pad and correct the problem. See list of arcing causes below.

Arcing is caused by

- Improper use of the wire shelf.
- Metal or foil touching the side of the oven.
- Plates or dishes with metallic trim or glaze with a metallic sheen.

- Metal such as twist-ties, poultry pins or gold-rimmed dishes in the microwave.
- Recycled paper towels containing small metal pieces being used in the microwave.
- Food spills that are not cleaned up.
- Operating microwave with no food or liquid in the oven cavity. Never start a cooking cycle without food or liquid in the oven. If using the microwave as a timer always use the special timer feature.

IMPORTANT: Always remove the wire shelf before pressing Start pad to make popcorn. Leaving shelf in oven can cause damage to oven and shelf.

Using Aluminum Foil Containers

NOTE: Metal containers should not be used in a microwave oven. There are, however, some exceptions. If you have purchased food prepackaged in an aluminum foil container, refer to the instructions on the package. When using aluminum foil containers, cooking times may be longer because microwaves will only penetrate the top of the food. When using aluminum containers without package instructions, follow these guidelines:

- Place the container in a glass bowl and add some water so that it covers the bottom of the container more than 1/4 in. (.60 cm). This ensures even heating of the container bottom.
- Always remove the lid to avoid damage to the oven.
- Use only undamaged containers.
- Do not use containers taller than 3/4 in. (1.9 cm).
- The container must be at least half filled.
- To avoid arcing, there must be a minimum of 1/4 in. (.60 cm) between the aluminum container and the walls of the oven and also between two aluminum containers.
- Always place the container on the turntable.
- Shield, with small pieces of aluminum foil, parts of food that may cook quickly; such as wing tips and leg ends of poultry.
- Heating food in aluminum foil containers usually takes up to double the time compared to reheating in plastic, glass, china, or paper containers. The time when food is ready will vary depending upon the type of container used.
- Let food stand for 2 to 3 minutes after heating so that heat is spread evenly throughout container.

Using Your Microwave Oven

This section gives instructions for operating each function. Please read this section carefully.

CLOCK & SETTINGS (Control Panel Feature 19)

The microwave oven has settings that allow you to customize the operation for your convenience. Below is the table showing the various settings. Touch the Clock & Settings key multiple times to scroll to the desired setting function.

Key press	Option
Clock & Settings	Clock
Clock & Settings	Control Lock On/Off
Clock & Settings	Turntable On/Off
Clock & Settings	Clean
Clock & Settings	Sound On/Off
Clock & Settings	Weight lb/kg
Clock & Settings	Demo mode On/Off

SETTING CLOCK (Control Panel Feature 19)

The clock can be disabled when the microwave is first plugged in and the STOP key is selected. To re-enable the clock follow clock instructions.

Example: To set the clock for 10:59.

Touch: **Display Shows:**

1. Clock & Settings 12:00 ENTER TIME
PRESS AGAIN FOR OPTIONS/

2. (1) (0) (5) (9) 10:59
PRESS START

3.  10:59
ADD 30 SEC

NOTE:

- If you begin to enter in an incorrect time (e.g. 2:89) the 8 is an invalid digit and cannot be entered. Enter the correct time.
- If you touch STOP while setting the clock, the display will show the last time of day set or a blank display if no time of day has been set.

SETTING CONTROL LOCK ON/OFF (Control Panel Feature 19)

To turn ON Control Lock touch Clock & Settings twice.

Touch:

Display Shows:

1. Clock & Settings

PRESS AGAIN FOR OPTIONS/
12:00 ENTER TIME

2. Clock & Settings

PRESS AGAIN FOR OPTIONS/ PRESS START
CONTROL LOCK

3. 
ADD 30 SEC

Time of day
if time of day was set
LOCK

To turn OFF the Control Lock, touch Clock & Settings then touch

ADD 30 SEC

SETTING TURNTABLE ON/OFF (Control Panel Feature 19)

Press Turntable On-Off to turn the turntable on or off.

For best cooking results, leave the turntable on. It can be turned off for large dishes. Turntable cannot be turned off in convection or preprogrammed cycles.

Touch:

Display Shows:

1. Clock & Settings

PRESS AGAIN FOR OPTIONS/
12:00 ENTER TIME

2. Clock & Settings

PRESS AGAIN FOR OPTIONS/ PRESS START
CONTROL LOCK

3. Clock & Settings

PRESS AGAIN FOR OPTIONS/ PRESS START
TURNTABLE ON

4. 
ADD 30 SEC

TT OFF

CAUTION: Sometimes the turntable can become hot to the touch during and after cooking. Do not run the oven empty without food in it.

USING CLEAN (Control Panel Feature 19)



To enter Clean mode touch Clock & Settings four times.

This is a preset timed cycle to boil water creating steam to soften soils inside the microwave oven. When the cycle is done remove the water and wipe the inside of the microwave with cloth.

NOTE: Place two cups of water in the microwave oven. To get rid of odors inside the oven add some lemon juice or vinegar into the water.

Touch:

Display Shows:

- | | |
|--|---|
| 1. Clock & Settings | <small>PRESS AGAIN FOR OPTIONS/</small>
12:00 ENTER TIME |
| 2. Clock & Settings | <small>PRESS AGAIN FOR OPTIONS/ PRESS START</small>
CONTROL LOCK |
| 3. Clock & Settings | <small>PRESS AGAIN FOR OPTIONS/ PRESS START</small>
TURNTABLE ON |
| 4. Clock & Settings | <small>PRESS AGAIN FOR OPTIONS/ PRESS START</small>
CLEAN |
| 5. 
ADD 30 SEC | <small>PRESS START</small>
SEE MANUAL |
| 6. 
ADD 30 SEC | CLEANING |

TURNING SOUND ON/OFF (Control Panel Feature 19)

Audible signals are available to guide you when setting and using your oven.

- **A programming tone** will sound each time you touch a pad.
- **Three tones** signal the end of a Kitchen Timer countdown.
- **Three tones** signal the end of a cooking cycle.

Example: To turn audible signal on or off.

Touch:

Display Shows:

- | | |
|---|---|
| 1. Clock & Settings | <small>PRESS AGAIN FOR OPTIONS/</small>
12:00 ENTER TIME |
| 2. Clock & Settings | <small>PRESS AGAIN FOR OPTIONS/ PRESS START</small>
CONTROL LOCK |
| 3. Clock & Settings | <small>PRESS AGAIN FOR OPTIONS/ PRESS START</small>
TURNTABLE ON |
| 4. Clock & Settings | <small>PRESS AGAIN FOR OPTIONS/ PRESS START</small>
CLEAN |
| 5. Clock & Settings | <small>PRESS AGAIN FOR OPTIONS/ PRESS START</small>
SOUND ON |
| 6. 
ADD 30 SEC | OFF |

When START is pressed and the previous setting was ON then it will be set to OFF. If you want to turn the audible signal back ON you will have to again press Clock & Settings five times and then START.

When the cooking cycle is completed END will be displayed and the audible signal will sound if the sound is turned on.

SETTING WEIGHT LB/KG (Control Panel Feature 19)

Example: To toggle weight between pounds & kilograms.

Touch:	Display Shows:
1. Clock & Settings	<small>PRESS AGAIN FOR OPTIONS/</small> 12:00 ENTER TIME
2. Clock & Settings	<small>PRESS AGAIN FOR OPTIONS/ PRESS START</small> CONTROL LOCK
3. Clock & Settings	<small>PRESS AGAIN FOR OPTIONS/ PRESS START</small> TURNTABLE ON
4. Clock & Settings	<small>PRESS AGAIN FOR OPTIONS/ PRESS START</small> CLEAN
5. Clock & Settings	<small>PRESS AGAIN FOR OPTIONS/ PRESS START</small> SOUND ON
6. Clock & Settings	<small>PRESS AGAIN FOR OPTIONS/ PRESS START</small> KG / LB
7.  ADD 30 SEC	KG <small>kg</small>

If the display shows kg, pressing the START button will reset the oven controls to lbs. To return to kg, you will have to again press Clock & Settings six times and then START.

SETTING DEMO MODE ON/OFF (Control Panel Feature 19)

Example: To enter Demo mode.





Touch:	Display Shows:
1. Clock & Settings	<small>PRESS AGAIN FOR OPTIONS/</small> 12:00 ENTER TIME
2. Clock & Settings	<small>PRESS AGAIN FOR OPTIONS/ PRESS START</small> CONTROL LOCK
3. Clock & Settings	<small>PRESS AGAIN FOR OPTIONS/ PRESS START</small> TURNTABLE ON
4. Clock & Settings	<small>PRESS AGAIN FOR OPTIONS/ PRESS START</small> CLEAN
5. Clock & Settings	<small>PRESS AGAIN FOR OPTIONS/ PRESS START</small> SOUND ON
6. Clock & Settings	<small>PRESS AGAIN FOR OPTIONS/ PRESS START</small> KG / LB
7. Clock & Settings	<small>PRESS AGAIN FOR OPTIONS/ PRESS START</small> DEMO OFF
8.  ADD 30 SEC	ON

When START is pressed and the previous setting was OFF then it will be set to ON. If you want to turn the demo mode back OFF you will have to again press Clock & Settings seven times and then START.

SETTING KITCHEN TIMER (Control Panel Feature 17)

Your microwave oven can be used as a kitchen timer. You can set up to 99 minutes, 99 seconds. The kitchen timer can be used while the microwave oven is running.

Example: To set for three minutes.

Touch:	Display Shows:
1. Kitchen Timer	<small>TIMER</small> ENTER TIME
2.   	<small>TIMER</small> 3:00 <small>PRESS START</small>
3.  ADD 30 SEC	<small>TIMER</small> 3:00 Timer starts counting down

NOTE: Timer count down does not stop even if the door is open. To cancel the timer, press the STOP key once.

USING VENT FAN (Control Panel Feature 20)

The pad controls the 4-speed vent fan. If the vent fan is OFF the first touch of the Vent pad will turn the fan on TURBO, second touch HIGH, third touch MEDIUM, fourth touch LOW, fifth touch OFF.

Example: To set the vent fan speed to HIGH from the OFF position.

Touch:	Display Shows:
1. Vent 4 SPEEDS - OFF	TURBO
2. Vent 4 SPEEDS - OFF	HIGH

Turn off fan when desired

NOTE: If the temperature from the range or cooktop below the oven gets too hot, the vent fan will automatically turn on to protect the oven. It may stay on up to an hour to cool the oven. When this occurs, the Vent pad will not turn the fan off.

USING VENT DELAY (Control Panel Feature 21)

The pad controls the vent delay time.

Example: Set the delay time 10 minutes at HIGH speed from the OFF position.

Touch:	Display Shows:
1. Vent 4 SPEEDS - OFF	TURBO
2. Vent 4 SPEEDS - OFF	HIGH
3. Vent SET DELAY	1:00
4. Vent SET DELAY	3:00
5. Vent SET DELAY	5:00
6. Vent SET DELAY	10:00
7.  ADD 30 SEC	DELAY

USING COOKTOP LIGHT (Control Panel Feature 22)





The pad controls the cooktop light. If the light is OFF the first touch of the light pad will turn the light ON (high), second touch Nite(low) and third touch OFF.

Example: To set the light for HIGH from the OFF position.

Touch:	Display Shows:
1. Light ON-NITE-OFF	ON

SETTING TIMED COOK (Control Panel Feature 5)

Example: To cook for five minutes, 30 seconds at 100% power.

Touch:	Display Shows:
1. Time Cook	ENTER COOK TIME
2.   	5:30 <small>PRESS START</small>
3.  ADD 30 SEC	5:30 <small>COOK</small> Time counting down

INTERRUPTING COOKING

You can stop the oven during a cycle by opening the door. The oven stops heating and the fan turns off, but the light stays on.

To restart cooking, close the door and Touch.



If you do not want to continue cooking, open the door and touch



USING ONE TOUCH START



This is a time saving pad that will automatically start cooking 2 seconds after selected. Numeric key 1 to 6 can be touched for a 1 minute to 6 minutes automatic start cooking feature.

Touch:	Display Shows:
1. 	2:00 <small>COOK</small> Time counting down

USING ADD 30 SEC. (Control Panel Feature 15)

This is a time-saving pad. It is a simplified feature that lets you quickly set and start microwave cooking at 100% power.

Example: To cook for one minute.

- | Touch: | Display Shows: |
|--|---|
| 1. 
ADD 30 SEC | :30
<small>COOK</small> |
| 2. 
ADD 30 SEC | 1:00
<small>COOK</small>
Time counting down |





NOTE: Each time you touch ADD 30 SEC, it will add 30 seconds up to 99 minutes 99 seconds.

SETTING TIMED COOKING WITH POWER LEVEL

This feature lets you program a specific cook time and power. For best results, there are 10 power level settings in addition to HIGH (100%) power. Refer to the "Microwave Power Levels" table.

NOTE: If you do not select a power level, the oven will automatically cook at HIGH (100%) power.









Example: To cook for five minutes, 30 seconds at 80% power.

- | Touch: | Display Shows: |
|--|---|
| 1. Time Cook | ENTER COOK TIME |
| 2.    | 5:30
<small>PRESS START</small> |
| 3. Power Level | PL-HI
<small>PRESS START</small> |
| 4.  | PL-80
<small>PRESS START</small> |
| 5. 
ADD 30 SEC | 5:30
<small>COOK</small>
Time counting down |

SETTING TWO-STAGE COOKING

For best results, some recipes call for different power levels during a cook cycle. You can program your oven for two power level stages during the cooking cycle.

Example: To set a 2-stage cook cycle. The first stage is a 3 minute cook time at 80% cook power then a 7 minute cook time at 50% cook power.

- | Touch: | Display Shows: |
|---|---|
| 1. Time Cook | ENTER COOK TIME |
| 2.    | 3:00
<small>PRESS START</small> |
| To set a 3 minute cook time for first stage. | |
| 3. Power Level | PL-HI
<small>PRESS START</small> |
| 4.  | PL-80
<small>PRESS START</small> |
| To set an 80% cook power for the first stage. | |
| 5. Time Cook | ENTER COOK TIME |
| 6.    | 7:00
<small>PRESS START</small> |
| To set a 7 minute cook power for the second stage. | |
| 7. Power Level | PL-HI
<small>PRESS START</small> |
| 8.  | PL-50
<small>PRESS START</small> |
| To set a 50% cook power for the second stage. | |
| NOTE: You can program a "0" power second stage for standing time inside the oven. | |
| 9. 
ADD 30 SEC | 3:00
<small>COOK</small>
Time counting down |

MICROWAVE POWER LEVELS

For best results, some recipes call for different cook powers. The lower the cook power, the slower the cooking. Each number from 1 to 9 stands for a different percentage of full cook power.

The following table gives the percentage of cook power each number pad stands for, and the cook power name usually used.

The table also tells you when to use each cook power. Follow recipe or food package instructions if available.

NOTE: Refer to a reliable cookbook for cooking times based on the 1050 Watt cook power of your microwave oven.

COOK POWER	LEVEL	WHEN TO USE IT
100% of full power	High	<ul style="list-style-type: none"> • Quickly heating convenience foods and foods with high water content, such as soup and beverages. • Cooking tender cuts of meat, ground meat or chicken.
9 = 90% of full power		<ul style="list-style-type: none"> • Heating cream soups.
8 = 80% of full power		<ul style="list-style-type: none"> • Heating rice, pasta, or casseroles.
7 = 70% of full power	Medium-High	<ul style="list-style-type: none"> • Cooking and heating foods that need a Cook Power lower than High (for example, whole fish and meat loaf) or when food is cooking too fast. • Reheating a single serving of food.
6 = 60% of full power		<ul style="list-style-type: none"> • Cooking that requires special care, such as cheese and egg dishes, pudding, and custards. • Finishing cooking casseroles.
5 = 50% of full power	Medium	<ul style="list-style-type: none"> • Cooking ham, whole poultry, and pot roasts. • Simmering stews.
4 = 40% of full power		<ul style="list-style-type: none"> • Melting chocolate. • Heating pastries.
3 = 30% of full power	Medium-Low, Defrost	<ul style="list-style-type: none"> • Manually defrosting precooked and other foods, such as bread, fish, meats and poultry.
2 = 20% of full power		<ul style="list-style-type: none"> • Softening butter, cheese, and ice cream.
1 = 10% of full power	Low	<ul style="list-style-type: none"> • Keeping food warm. • Taking chill out of fruit.
0 = 0% of full power	None	<ul style="list-style-type: none"> • Standing time in oven.

USING AUTO DEFROST











Four defrost sequences are preset in the oven. The auto defrost feature provides you with the best defrosting method for frozen foods. The cooking guide will show you which defrost sequence is recommended for the food you are defrosting.

For added convenience, the Auto Defrost includes a built-in beep mechanism that reminds you to check, turn over, separate, or rearrange the food in order to get the best defrost results. Four different defrosting levels are provided:

1. MEAT
2. POULTRY
3. FISH
4. BREAD

Available weight is 0.1-6.0 lbs

Example: To defrost 1.2 lbs of fish.

Touch:	Display Shows:
1. Auto Defrost	<small>PRESS AGAIN FOR OPTIONS/ PRESS START</small> 
2. Auto Defrost	<small>PRESS AGAIN FOR OPTIONS/ PRESS START</small> 
3. Auto Defrost	<small>PRESS AGAIN FOR OPTIONS/ PRESS START</small> 
4.  ADD 30 SEC	
5.  and  To enter weight	<small>PRESS START</small> 
6.  ADD 30 SEC	<small>DEFR.</small>  Time counting down

NOTE:

The oven will beep during the DEFROST cycle. At this time, open the door and turn, separate, or rearrange the food. Remove any portions that have thawed. Return frozen portions to the oven and touch START to resume the defrost cycle.

OPERATING TIPS

- For best results, remove fish, shellfish, meat, and poultry from its original closed paper or plastic package (wrapper). Otherwise, the wrap will hold steam and juice close to the foods, which can cause the outer surface of the foods to cook.
- For best results, roll your ground meat into a ball before freezing. During the DEFROST cycle, the microwave will signal when it is time to turn the meat over. Scrape off any excess frost from the meat and continue defrosting.
- Place foods in a shallow container or on a microwave roasting rack to catch drippings.

This table shows food type selections and the weights you can set for each type. For best results, loosen or remove covering on food.

KEY PRESS	Category	WEIGHTS YOU CAN SET (tenths of a pound)
Auto Defrost	Meat	0.1 to 6.0
Auto Defrost	Poultry	0.1 to 6.0
Auto Defrost	Fish	0.1 to 6.0
Auto Defrost	Bread	0.1 to 6.0

Weight conversion table

You are probably used to measuring food in pounds and ounces that are fractions of a pound (for example, 4 ounces equals 1/4 pound). However, in order to enter food weight in Auto Defrost, you must specify pounds and tenths of a pound.

If the weight on the food package is in fractions of a pound, you can use the following table to convert the weight to decimals.

Equivalent Weight	
OUNCES	DECIMAL WEIGHT
1.6	.10
3.2	.20
4.0	.25 One-Quarter Pound
4.8	.30
6.4	.40
8.0	.50 One-Half Pound
9.6	.60
11.2	.70
12.0	.75 Three-Quarters Pound
12.8	.80
14.4	.90
16.0	1.0 One Pound

NOTE: If between two decimal weights, choose the lower weight for the best defrosting results.

AUTO DEFROST TABLE

NOTE: Meat of irregular shape and large, fatty cuts of meat should have the narrow or fatty areas shielded with foil at the beginning of the defrost sequence.

MEAT SETTINGS

FOOD	SETTING	AT BEEP	SPECIAL INSTRUCTIONS
BEEF			
Ground Beef, Bulk	MEAT	Remove thawed portions with fork. Turn over. Return remainder to oven.	Do not defrost less than 1/4 lb. Freeze in ball shape.
Ground Beef, Patties	MEAT	Separate and rearrange.	Do not defrost less than 2 oz. patties. Depress center when freezing.
Round Steak	MEAT	Turn over. Cover warm areas with aluminum foil.	Place in a microwave safe dish.
Tenderloin Steak	MEAT	Turn over. Cover warm areas with aluminum foil.	Place in a microwave safe dish.
Stew Beef	MEAT	Remove thawed portions with fork. Separate remainder.	Place in a microwave safe dish.
Pot Roast, Chuck Roast	MEAT	Turn over. Cover warm areas with aluminum foil.	Place in a microwave safe dish.
Rib Roast	MEAT	Turn over. Cover warm areas with aluminum foil.	Place in a microwave safe dish.
Rolled Rump Roast	MEAT	Turn over. Cover warm areas with aluminum foil.	Place in a microwave safe dish.
LAMB			
Cubes for Stew	MEAT	Turn over. Cover warm areas with aluminum foil.	Place in a microwave safe dish.
Chops (1 inch thick)	MEAT	Separate and rearrange. Return remainder to oven.	Place in a microwave safe dish.
PORK			
Chops (1/2 inch thick)	MEAT	Separate and rearrange.	Place in a microwave safe dish.
Hot Dogs	MEAT	Separate and rearrange.	Place in a microwave safe dish.
Spareribs Country-style Ribs	MEAT	Turn over. Cover warm areas with aluminum foil.	Place in a microwave safe dish.
Sausage, Links	MEAT	Separate and rearrange.	Place in a microwave safe dish.
Sausage, Bulk	MEAT	Remove thawed portions with fork. Turn over. Return remainder to oven.	Place in a microwave safe dish.
Loin Roast, Boneless	MEAT	Turn over. Cover warm areas with aluminum foil.	Place in a microwave safe dish.

AUTO DEFROST TABLE (CONTINUED)

POULTRY SETTINGS

FOOD	SETTING	AT BEEP	SPECIAL INSTRUCTIONS
CHICKEN Whole (up to 6 lbs) Cut-up	POULTRY	Turn over breast side down. Cover warm areas with aluminum foil. Separate pieces and rearrange. Turn over. Cover warm areas with aluminum foil.	Place chicken breast-side up in a microwave safe dish. Finish defrosting by immersing in cold water. Remove giblets when chicken is partially defrosted. Place in a microwave safe dish. Finish defrosting by immersing in cold water.
CORNISH HENS Whole	POULTRY	Turn over. Cover warm areas with aluminum foil.	Place in a microwave safe dish. Finish defrosting by immersing in cold water.
TURKEY Breast (up to 6 lbs)	POULTRY	Turn over. Cover warm areas with aluminum foil.	Place in a microwave safe dish. Finish defrosting by immersing in cold water.

FISH SETTINGS

FOOD	SETTING	AT BEEP	SPECIAL INSTRUCTIONS
FISH Fillets Steaks Whole	FISH FISH FISH	Turn over. Separate fillets when partially thawed, if possible. Separate and rearrange. Turn over.	Place in a microwave safe dish. Carefully separate fillets under cold water. Place in a microwave safe dish. Run cold water over to finish defrosting. Place in a microwave safe dish. Cover head and tail with foil; do not let foil touch sides of microwave. Finish defrosting by immersing in cold water.
SHELLFISH Crab meat Lobster tails Shrimp Scallops	FISH FISH FISH FISH	Break apart. Turn over. Turn over and rearrange. Separate and rearrange. Separate and rearrange.	Place in a microwave safe dish. Place in a microwave safe dish. Place in a microwave safe dish. Place in a microwave safe dish.

DEFROSTING TIPS

- When using Auto Defrost, the weight to be entered is the net weight (the weight of the food minus the container).
- Before starting, make sure to remove any and all metal twist-ties that often come with frozen food bags, and replace them with strings or elastic bands.
- Open containers, such as cartons, before placing in the oven.
- Always slit or pierce plastic pouches or packaging.
- If food is foil wrapped, remove foil and place food in a suitable container.
- Slit the skin of skinned food, such as sausage.
- Bend plastic pouches of food to ensure even defrosting.
- Always underestimate defrosting time. If defrosted food is still icy in the center, return it to the microwave oven for more defrosting.
- The length of defrosting time varies according to how solidly the food is frozen.
- The shape of the package affects how quickly food will defrost. Shallow packages will defrost more quickly than a deep block.
- As food begins to defrost, separate the pieces. Separated pieces defrost more easily.
- Use small pieces of aluminum foil to shield parts of food such as chicken wings, leg tips, fish tails, or areas that start to get warm. Make sure the foil does not touch the sides, top, or bottom of the oven. The foil can damage the oven lining.
- For better results, let food stand after defrosting. (For more information on standing time, see the "Microwave Cooking Tips" section).
- Turn over food during defrosting or standing time. Break apart and remove food as required.

SENSOR OPERATING INSTRUCTIONS

Sensor Cook allows you to cook most of your favorite foods without selecting cooking times and power levels. The display will indicate Sensing during the initial sensing period.

The oven automatically determines required cooking time for each food item. When the internal sensor detects a certain amount of humidity coming from the food, it will tell the oven how much longer to heat. The display will show the remaining heating time. For best results for cooking by Sensor, follow these recommendations.

1. Food cooked with the sensor system should be at normal storage temperature.
2. Always use microwavable containers.
3. Match the amount to the size of the container.
Fill containers at least half full for best results.

4. Be sure the outside of the cooking container and the inside of the microwave oven are dry before placing food in the oven. Beads of moisture turning into steam can mislead the sensor.
5. Foods should always be covered with microwavable plastic wrap, waxed paper, or a lid. Never use tight-sealing plastic covers. They can prevent steam from escaping and cause food to overcook.
6. Do not open the door or touch the STOP key during the sensing time. When sensing time is over, the oven beeps and the remaining cooking time will appear in the display window. At this time you can open the door to stir, turn, or rearrange the food.

USING SENSOR COOK (Control Panel Feature 7)

Using SENSOR COOK lets you cook common microwave-prepared foods without needing to program times and cook powers.

Example: To cook frozen pizza with sensor.

Touch:

Display Shows:

1. Sensor Cook

PRESS AGAIN FOR OPTIONS/ PRESS START
BACON
SENSOR

2. Sensor Cook

PRESS AGAIN FOR OPTIONS/ PRESS START
FROZEN DINNER
SENSOR

3. Sensor Cook

PRESS AGAIN FOR OPTIONS/ PRESS START
RICE
SENSOR

4. Sensor Cook

PRESS AGAIN FOR OPTIONS/ PRESS START
FROZEN BREAKFAST
SENSOR

5. Sensor Cook

PRESS AGAIN FOR OPTIONS/ PRESS START
FROZEN PIZZA
SENSOR

6. 
ADD 30 SEC

FROZEN PIZZA
SENSOR COOK

Sensor Cook selections are made by touching the Sensor Cook key multiple times.

USING SENSOR REHEAT (Control Panel Feature 6)

Using SENSOR REHEAT lets you reheat common microwave-prepared foods without selecting cooking times and power levels.

Example: To reheat casserole with sensor reheat.

Touch:

Display Shows:

1. Sensor Reheat

PRESS AGAIN FOR OPTIONS/ PRESS START
BEVERAGE
SENSOR

2. Sensor Reheat

PRESS AGAIN FOR OPTIONS/ PRESS START
DINNER PLATE
SENSOR

3. Sensor Reheat

PRESS AGAIN FOR OPTIONS/ PRESS START
SOUP SAUCE
SENSOR

4. Sensor Reheat

PRESS AGAIN FOR OPTIONS/ PRESS START
CASSEROLE
SENSOR

5. 
ADD 30 SEC

CASSEROLE
SENSOR COOK

Sensor Reheat selections are made by touching the Sensor Reheat key multiple times.

SENSOR COOK TABLE

CATEGORY	DIRECTION	AMOUNT
Bacon	Place bacon strips on a microwave bacon rack for best results. (Use dinner plate lined with paper towels if rack is not available).	1-3 slices
Frozen Dinner	Place in an appropriately sized microwave container. Cover with plastic wrap. After cooking, stir and allow to stand for 3 minutes.	10 oz./ 20 oz.
Rice	Place rice and twice as much liquid (water, chicken or vegetable stock) in a 2 quart mic rowave dish. Cover with plastic wrap and vent. After cooking, allow to stand for 10 minutes. Stir for fluffier rice.	1-2 cups Use medium or long grain rice. Cook instant rice according to directions on the package.
Frozen Breakfast	Place in an appropriately sized microwave container. Cover with plastic wrap. After cooking, stir and allow to stand for 3 minutes.	8/12 oz.
Frozen Pizza	Remove from package. Place on an appropriately sized microwavable plate. For prepackaged microwavable pizza follow the instructions on the package.	8/12 oz.

SENSOR REHEAT TABLE

CATEGORY	DIRECTION	AMOUNT
Beverage	Do not cover.	1-3 cups
Dinner Plate	Place on a low plate. Cover with vented plastic wrap. Let stand 3 minutes after cooking.	1-2 servings
Soup/Sauce	Place in shallow microwavable casserole. Cover with vented plastic wrap. After cooking, stir and let stand 3 minutes.	1-2 cups
Casserole/ Lasagna	Place in a microwavable bowl or casserole. Cover with vented plastic wrap. After cooking, stir and let stand 3 minutes.	10.5 oz.

USING QUICK TOUCH

Your microwave has preprogrammed selections to cook food automatically.

SETTING POPCORN (Control Panel Feature 8)

The Popcorn quick touch pad lets you pop 3.3, 3.0, 1.75 ounce bags of commercially packaged microwave popcorn. Pop only one package at a time. If you are using a microwave popcorn popper, follow manufacturer's instructions.

NOTE: Remove the wire shelf from microwave oven when cooking popcorn. Do not use regular paper bags. Do not re-pop unpopped kernels. Do not pop popcorn in glass cookware.

Example: To pop a 3.3 oz. popcorn.

Touch:

- Popcorn

Display Shows:
PRESS AGAIN FOR OPTIONS/ PRESS START
 3.3 oz

-  **START**
ADD 30 SEC

Display Shows:
PRESS AGAIN FOR OPTIONS/ PRESS START
 POPCORN
COOK
 Time counting down

Key press	Selection	Amount
Popcorn	3.3	3.3 oz (94g)
Popcorn	3.0	3.0 oz (85g)
Popcorn	1.75	1.75 oz (50g)

SETTING VEGGIES (Control Panel Feature 9)

The Veggies quick touch pad lets you cook potatoes, fresh and frozen vegetables.

Example: To cook Frozen veggies.

Touch:

- Veggies

Display Shows:
PRESS AGAIN FOR OPTIONS/ PRESS START
 POTATO
SENSOR

- Veggies

Display Shows:
PRESS AGAIN FOR OPTIONS/ PRESS START
 FRESH VEGGIES

- Veggies

Display Shows:
PRESS AGAIN FOR OPTIONS/ PRESS START
 FROZEN VEGGIES

-  **START**
ADD 30 SEC

Display Shows:
PRESS AGAIN FOR OPTIONS/ PRESS START
 FROZEN VEGGIES
COOK
 Time counting down

Key	Food	Amount
Veggies x1	Potato	1-4
Veggies x2	Fresh Veggies	1-4 cups
Veggies x3	Frozen Veggies	1-4 cups

Touch Veggie key repeatedly to switch between Potato, Fresh and Frozen selections.

SETTING PIZZA (Control Panel Feature 10)

The Pizza sensor cook quick touch pad lets you reheat up to four slices of pizza (based on a 5 ounce slice).

NOTE:

- Place on a plate and paper towel
- Do not cover

Example: To reheat 1 to 4 slices of Pizza.

Touch:

- Pizza

Display Shows:
PRESS START
 PIZZA
SENSOR

-  **START**
ADD 30 SEC

Display Shows:
PRESS START
 PIZZA
SENSOR COOK

FAVORITE (Control panel Feature 12)

Touch this pad to select one of several preprogrammed items.

Example: To recall garlic shrimp cook setting.

Touch:

- Favorites

Display Shows:
PRESS AGAIN FOR OPTIONS/ PRESS START
 CHOCOLATE CHIP
 COOKIES

- Favorites

Display Shows:
PRESS AGAIN FOR OPTIONS/ PRESS START
 ROSEMARY ROASTED
 CHICKEN

- Favorites

Display Shows:
PRESS AGAIN FOR OPTIONS/ PRESS START
 GARLIC SHRIMP

-  **START**
ADD 30 SEC

Display Shows:
PRESS AGAIN FOR OPTIONS/ PRESS START
 GARLIC SHRIMP
COOK
 Time counting down

Key	Food
Favorites x1	Chocolate Chip Cookies
Favorites x2	Rosemary Roasted Chicken
Favorites x3	Garlic Shrimp
Favorites x4	Stuffed Mushrooms
Favorites x5	Asiago Red Potatoes
Favorites x6	Roasted Vegetable Medley
Favorites x7	Spiced Pecans
Favorites x8	Baked Apples with Caramel
Favorites x9	Marinated Flank Steak
Favorites x10	Savory Sweet Potatoes

NOTE: Refer to page 35-36 for favorite recipes.

SETTING MELT/SOFTEN (Control panel Feature 13)

The oven uses low power to melt and soften items. See the following table.

Example: To melt 2 sticks of Butter.

Touch:

Display Shows:

1. Melt / Soften

PRESS AGAIN FOR OPTIONS/ PRESS START
MELT BUTTER

2.  START
ADD 30 SEC

ENTER 1-2 STK

3. 

PRESS START
2 STICK

4.  START
ADD 30 SEC

MELT BUTTER
COOK

Time counting down

Key	Food	Amount	Key
Melt / Soften x1	Melt Butter	1 stick	1
		2 sticks	2
Melt / Soften x2	Melt Chocolate	2 oz.	2
		4 oz.	4
		8 oz.	8
Melt / Soften x3	Soften Ice Cream	Pint	1
		1.5 Quart	2
Melt / Soften x4	Soften Cream Cheese	3 oz.	3
		8 oz.	8

MELT/SOFTEN TABLE

CATEGORY	DIRECTION	AMOUNT
BUTTER	Unwrap and place in microwavable container. No need to cover butter. Stir at the end of cooking to complete melting.	1 or 2 sticks
CHOCOLATE	Chocolate chips or squares of baking chocolate may be used. Unwrap squares and place in microwavable container. Stir at the end of cycle to complete melting.	2, 4 or 8 oz.
ICE CREAM	Place container in oven. Ice cream will be soft enough to make scooping easier.	Pint, 1.5 Quart.
CREAM CHEESE	Unwrap and place in microwavable container. Cream cheese will be at room temperature and ready for use in recipe.	3 or 8 oz.

TIPS FOR CONVECTION COOKING

This section gives you cooking instructions and procedures for operating each convection function. Please read these instructions carefully.

Convection cooking circulates hot air through the oven cavity with a fan. The constantly moving air surrounds the food to heat the outer portion quickly, creating even browning and sealed-in flavor by the constant motion of hot air over the food surfaces. Your oven uses convection cooking whenever you use the Convection Button. **DO NOT USE THE OVEN WITHOUT THE TURNTABLE IN PLACE.**

1. **Always use the metal platform rack** on the turntable or the flat rectangular wire rack when convection cooking.
2. **Do not cover** turntable or metal platform rack with aluminum foil. It interferes with the flow of air that cooks the food.
3. **Round pizza pans** are excellent cooking utensils for many convection-only items. Choose pans that do not have extended handles.
4. **Use convection cooking** for items like souffles, breads, cookies, angel food cakes, pizza, and for some meat and fish.
5. **You do not need to use** any special techniques to adapt your favorite oven recipes to convection cooking; however, you need to lower oven temperature by 25°F from recommended temperature mentioned in package instructions when cooking packaged food in convection mode.
6. **When baking** cakes, cookies, breads, rolls, or other baked foods, most recipes call for preheating. Preheat the empty oven just as you do a regular oven. You can start heavier dense foods such as meats, casseroles, and poultry without preheating.
7. **All heat-proof** cookware or metal utensils can be used in convection cooking.
8. **Use metal utensils** only for convection cooking. Never use for microwave or combination cooking since arcing and damage to the oven may occur.
9. **After preheating**, if you do not open the door, the oven will automatically hold at the preheated temperature for 30 minutes.

PRECAUTIONS

- The oven cavity, door, turntable, roller rest, wire shelf, metal platform rack, and cooking utensils will become very hot. **USE THICK OVEN GLOVES** when removing the food, cooking utensils, metal platform rack, wire shelf, and turntable from the oven after convection cooking.
- Do not use lightweight plastic containers, plastic wraps, or paper products during any convection.

CONVECTION KEEP WARM (Control panel Feature 2)

The default keep warm temperature is 170 degrees.

Example: To keep warm for 20 minutes.

Touch:	Display Shows:
1. <small>CONVECTION</small> Keep Warm	<small>PRESS START</small> ENTER TIME
2. (2) (0) (0) (0)	<small>PRESS START</small> 20:00
3.  ADD 30 SEC	<small>CONVECT</small> 20:00 Time counting down

NOTE: If you do not set a keep warm time, just press Convection Keep Warm then touch START, you can keep warm up to 90 minutes.

CONVECTION BAKE/ ROAST (Control panel Feature 3)

Example: To preheat to 400 degrees.



Touch:	Display Shows:
1. <small>CONVECTION</small> Bake/ Roast	<small>PRESS AGAIN FOR OPTIONS/</small> PREHEAT ENTER TEMP
2. (8)	<small>PRESS START</small> 400 F
3.  ADD 30 SEC	PREHEAT <small>CONVECT</small>

The display will show PREHEAT up to 200 deg F. then display temperature in 25 degree increments (e.g. 225, 250). up to the set temperature.

NOTE:

- When the oven reaches the set preheat temperature, three (3) tones will sound and the display will scroll the message "PREHEAT END". The oven will automatically hold that temperature for 30 minutes.
- During convection cooking, the exhaust fan in the vent hood will automatically turn on at the low speed setting to protect the oven.

Example: To set the convection cooking at 350°F. for 20 minutes without preheating.

Touch:	Display Shows:
1. CONVECTION Bake/Roast	<small>PRESS AGAIN FOR OPTIONS/</small> PREHEAT ENTER TEMP
2. CONVECTION Bake/Roast	<small>PRESS AGAIN FOR OPTIONS/</small> BAKE/ROAST ENTER TEMP
3. (6)	<small>PRESS START</small> 350 F
4.  ADD 30 SEC	ENTER TIME
5. (2) (0) (0) (0)	<small>PRESS START</small> 20:00
6.  ADD 30 SEC	20:00 <small>CONVECT COOK</small> Time counting down

NOTE:

The temperature range has 10 steps from 100 °F to 450 °F.

Number Pad	Temperature
1	100 °F
2	200° F
3	250 °F
4	300° F
5	325 °F
6	350 °F
7	375° F
8	400° F
9	425 °F
0	450° F

CONVECTION BAKING GUIDELINES

1. Dark or non-shiny finishes, glass, and pyroceram absorb heat which may result in dry,crisp crusts.
2. Preheating the oven is recommended when baking foods by convection.
3. To prevent uneven heating and save energy, open the oven door to check food as little as possible.

Food		Oven Temp.	Time, Min.	Comments
Breads	Refrigerated Biscuits	375°F	11 to 14	Allow additional time for large biscuits.
	Corn Bread	350°F	35 to 40	
	Muffins	425°F	18 to 22	Remove from pans immediately and cool slightly on wire rack. Pierce each popover with a fork after removing from oven to allow steam to escape.
	Popovers	325°F	45 to 55	
	Nut Bread or Fruit Bread	325°F	60 to 70	
	Yeast Bread	375°F	16 to 23	
Plain or Sweet Rolls	350°F	13 to 16		
Cakes	Devil's Food	350°F	35 to 40	Place cake pan on metal platform rack . If using a 9X13 cake pan use wire shelf Cool in pan 10 minutes before inverting on wire rack.
	Fudge brownies	350°F	26 to 30	
	Coffee Cake	325°F	30 to 35	
	Cup Cakes	325°F	20 to 25	
	Fruit Cake (loaf)	275°F	90 to 100	
	Gingerbread	300°F	25 to 30	
	Butter Cakes, Cake	325°F	35 to 45	
	Tube Cake	325°F	35 to 45	
Pound Cake	325°F	30 to 40		
Cookies	Chocolate Chip	350°F	11 to 14	Place metal tray on metal platform rack. Allow extra time for frozen cookie dough. Place metal tray on metal platform rack.
	Sugar	350°F	11 to 14	
Fruits, Other Desserts	Baked Apples or Pears	350°F	35 to 40	Bake in cookware with shallow sides. Pudding is done when knife inserted near center comes out clean. Puncture puffs twice with toothpick to release steam after 25 minutes of baking time. When done, turn oven off and let shells stand in oven 1 hour to dry.
	Bread Pudding	300°F	35 to 40	
	Cream Puffs	400°F	30 to 35	
	Meringue Shells	300°F	30 to 35	

Notes:

- The temperatures in the table above are a guideline for your reference. Follow package or recipe instructions.
- The baking time in the table above is only a guideline for your reference. You need to adjust time according to the food condition or your preference. Check readiness at the minimum time.

CONVECTION BAKING GUIDELINES (cont'd)

Food		Oven Temp.	Time, Min.	Comments
Pies, Pastries	Frozen Pie	400°F	50 to 60	Place metal tray on metal platform rack and place in cold oven. Preheat oven, tray and metal platform rack to 400°F. When preheated, place frozen pie on metal tray and bake according to package time or until crust is browned and filling is hot.
	Meringue-Topped	450°F	9 to 11	Follow package directions for preparation.
	Two-Crust	400°F	50 to 55	Follow package directions for preparation.
	Quiche	350°F	30 to 35	Let stand 5 minutes before cutting.
	Pastry Shell	400°F	10 to 16	Pierce pastry with fork to prevent shrinkage.
Casseroles	Meat, Chicken, Seafood Combinations	350°F	20 to 40	Cook times vary with casserole size and ingredients.
	Pasta	350°F	25 to 45	Cook times vary with casserole size and ingredients.
	Potatoes, scalloped	350°F	55 to 60	Let stand 5 minutes before serving.
	Vegetable	350°F	25 to 35	Cook times vary with casserole size and ingredients.
Convenience Foods	Frozen Bread Dough	350°F	30 to 35	Follow package directions for preparation.
	Frozen Entree	325°F	70 to 80	Follow package directions for preparation.
	Frozen Pizza	400°F	25 to 35	Follow package directions for preparation. Pizza should not extend over the metal platform rack.
	Rising Crust			
	Frozen Pizza	400°F	17 to 21	Follow package directions for preparation. Pizza should not extend over the metal platform rack.
	French Fries Crinkle	450°F	15 to 19	Follow package directions for preparation.
	Cut Frozen Waffle	400°F	5 to 7	Follow package directions for preparation.
Frozen Cheese Sticks	450°F	6 to 8	Follow package directions for preparation.	
	Frozen Turnovers	450°F	18 to 22	Follow package directions for preparation.
Main Dishes	Meat Loaf	400°F	30 to 40	Let stand 5 minutes after cooking.
	Oven-Baked Stew	325°F	80 to 90	Brown meat before combining with liquid and vegetables.
	Swiss Steak	350°F	60 to 70	Let stand 2 minutes after cooking.
	Stuffed Peppers	350°F	40 to 45	Use green, red, or yellow peppers.
Vegetables	Acorn Squash Halves	375°F	55 to 60	Add ½ cup water to dish. Turn squash halves cut side up after 30 minutes of cook time and cover.
	Baked Potatoes	425°F	50 to 60	Pierce skin with fork before baking.
	Twice-Baked Potatoes	400°F	25 to 30	Pierce skin with fork before baking.

Notes:

- The temperatures in the table above are a guideline for your reference. Follow package or recipe instructions.
- The baking time in the table above is only a guideline for your reference. You need to adjust time according to the food condition or your preference. Check readiness at the minimum time.

MEAT ROASTING GUIDELINES FOR CONVECTION COOKING

Food		Oven Temp.	Time, Min. / lb.
Beef	Rib roast, bone-in	325°F	23 to 25
	Rib roast, boneless	325°F	28 to 33
	Tenderloin	300°F	15 to 20
	Pot Roast	300°F	30 to 35
	Chuck, Rump Roast	300°F	30 to 35
Ham	Meat Loaf (2 lbs.)	400°F	65 to 75
	Canned (3-lb. fully cooked)	325°F	18 to 20
	Butt (5-lb. fully cooked)	325°F	18 to 20
	Shank (5-lb. fully cooked)	325°F	18 to 20
Lamb	Bone-in	300°F	20 to 25
	Boneless	300°F	25 to 30
Pork	Bone-in	300°F	20 to 30
	Boneless	300°F	20 to 30
Poultry	Whole Chicken (2½ to 3½ lbs.)	375°F	25 to 35
	Chicken Pieces (2½ to 3½ lbs.)	425°F	10 to 12
	Duckling (4 to 5 lbs.)	375°F	30 to 35
	Turkey Breast (4 to 6 lbs.)	325°F	21 to 25
Seafood	Fish, whole (3 to 5 lbs.)	400°F	13 to 18
	Lobster Tails (6 to 8-oz. each)	350°F	8 to 9

Notes:

- The roasting time in the table above is only a guideline for your reference. You need to adjust the time according to the food condition or your preference. Check readiness at the minimum time.
- Use a meat thermometer to check the internal temperature of the food.

TIPS FOR COMBINATION COOKING

This section gives you instructions to operate each combination cooking function. Please read these instructions carefully. Sometimes combination microwave-convection cooking is suggested to get the best cooking results since it shortens the cooking time for foods that normally need a long time to cook. This cooking process also leaves meats juicy on the inside and crispy on the outside. In combination cooking, the convection heat and microwave energy alternate automatically.

HELPFUL HINTS FOR COMBINATION COOKING

1. **Meats** may be roasted directly on the metal platform rack or in a shallow roasting pan placed on the metal platform rack. When using the metal platform rack, please check your cooking guide for information on proper use.
2. **Less tender** cuts of beef can be roasted and tenderized using oven cooking bags.
3. **When baking**, check for doneness after cooking time is up. If not completely done, let stand in oven for a few minutes to complete cooking.

PRECAUTIONS

1. All cookware used for combination cooking must be BOTH microwave-safe and oven-safe.
2. During combination baking, some baking cookware may cause arcing when it comes in contact with the oven walls or metal accessory racks. Arcing is a discharge of electricity that occurs when microwaves come in contact with metal.
 - If arcing occurs, immediately stop the cooking cycle and place a microwavable safe dish between the pan and the metal rack.
 - We recommend you use the metal platform rack supplied with your oven. It has rubber feet that helps prevent arcing.
 - If arcing occurs with other baking cookware, do not use them for combination cooking.

MICRO+CONV COMBICOOK (Control panel Feature 4)

Example: To bake 15 minutes at 325 degree default.

Touch:

Display Shows:

1. MICRO+CONV
CombiCook

PRESS AGAIN FOR OPTIONS/ PRESS START
BAKE 325 F

2. 
ADD 30 SEC

ENTER TIME

3.    

PRESS START
15:00

4. 
ADD 30 SEC

15:00
MICRO + CONVECT COOK
Time counting down

Bake (Degrees F)	Key	Microwave Setting
325	Default	10%
250	3	10%
300	4	10%
325	5	10%
350	6	10%
375	7	10%
400	8	10%

Roast (Degrees F)	Key	Microwave Setting
300	Default	30%
325	5	30%
350	6	30%
375	7	30%
400	8	30%
425	9	30%
450	0	30%

COMBINATION ROAST COOKING GUIDE

Food		Oven Temp.	Time, Min. / lb.
Beef	Turn over after half of cooking time.		
	Rib roast, bone-in	325°F	10 to 14
	Rib roast, boneless	325°F	10 to 14
	Beef Tenderloin	375°F	10 to 14
	Chuck, Rump or Pot Roast	300°F	12 to 22
Ham	Turn over after half of cooking time.		
	Canned (3-lb. fully cooked)	300°F	7 to 9
	Butt (5-lb. fully cooked)	300°F	7 to 9
	Shank (5-lb. fully cooked)	300°F	7 to 9
Lamb	Turn over after half of cooking time.		
	Bone-in (2 to 4 lbs.)		
	Medium	300°F	13 to 18
	Well	300°F	18 to 23
	Boneless (2 to 4 lbs.)		
	Medium	300°F	14 to 19
	Well	300°F	19 to 24
Poultry	Turn over after half of cooking time.		
	Whole Chicken (2½ to 6 lbs.)	375°F	15 to 17
	Chicken Pieces (2½ to 6 lbs.)	375°F	15 to 18
	Cornish Hens (untied)		
	Unstuffed	425°F	15 to 18
	Stuffed	375°F	22 to 25
	Duckling	375°F	15 to 18
Turkey Breast (4 to 6 lbs.)	300°F	11 to 15	
Seafood	Fish		
	1 -lb. fillets	350°F	7 to 10
	Lobster Tails (6 to 8-oz. each)	350°F	10 to 15
	shrimp (1 to 2 lbs.)	350°F	9 to 14
	Scallops (1 to 2 lbs.)	350°F	8 to 13

Notes:

- The roasting time in the table above is only a guideline for your reference. You need to adjust the time according to the food condition or your preference. Check doneness at the minimum time.
- Use a meat thermometer to check the internal temperature of the food.

COMBINATION BAKE COOKING GUIDE

Food		Oven Temp.	Time, Min.	Comments
Pies, Pastries	Quiche	425°F	15 to 17	Let stand 5 minutes before cutting.
	Frozen Entree			
Convenience Foods	Pizza Rolls, Egg Rolls	375°F	39 to 43	Follow package directions for preparation.
	Pizza	450°F	4 to 6	
Vegetables	Baked Potatoes	450°F	23 to 26	Pierce skin with a fork before baking. Place on metal platform rack

Notes:

- The time in the table above is only a guideline for your reference. You need to adjust time according to the food condition or your preference. Check doneness at the minimum time on the package.

FAVORITE RECIPES

Chocolate Chip Cookies

2 ½ cups oats	1 cup brown sugar
2 cups all purpose flour	2 eggs
½ teaspoon salt	1 teaspoon vanilla
1 teaspoon baking powder	12 oz chocolate chips
1 teaspoon baking soda	1 ½ cups chopped pecans
1 cup butter, softened	4 oz Hershey bar, melted
1 cup sugar	

Process oats in a food processor or blender until ground to a powder. Add flour, salt, baking powder, and baking soda; pulse to blend. Set aside.

Cream butter, sugar and brown sugar in a large mixing bowl. Add eggs and vanilla, mixing well. Gradually add oat mixture, stirring until combined. Stir in chocolate chips, pecans, and melted chocolate.

Preheat microwave to 325 for convection bake. Cover metal platform rack with a sheet of wax paper. Drop 1 inch sized spoonfuls of dough onto wax paper. Place metal platform rack on turntable in preheated microwave. Bake for 12 minutes or until cookies are lightly browned. Remove from microwave and allow to cool. Repeat with remaining cookie dough.

Rosemary Roasted Chicken

1 (4 pound) whole chicken, rinsed	½ small onion, quartered
1 tablespoon olive oil	6 sprigs fresh rosemary
½ lemon or 2 tablespoons lemon juice	6 sprigs fresh sage
Salt and pepper to taste	

Place chicken in shallow microwave safe casserole dish; rub with olive oil. Squeeze juice from lemon over chicken, reserving lemon. Season with salt and pepper to taste. Place reserved lemon half, onion, rosemary and sage in cavity.

Place casserole dish on metal platform rack on turntable. Micro-convection roast at 375 for 90 minutes or until instant read thermometer inserted in breast reaches 165°F. Remove from microwave, cover with waxed paper, and allow to stand 15 minutes before carving.

Garlic Shrimp

¼ cup butter	1 tablespoon chili pepper paste
6 cloves garlic, minced	Salt to taste
2 tablespoons chopped fresh chives	1 pound raw, peeled and deveined large shrimp
2 tablespoons lemon juice	

Place butter in a 2 quart microwave safe casserole dish with lid. Microwave on High power for 1 minute or until butter is melted. Stir in garlic, and microwave for an additional 1 minute. Stir in chives, lemon juice, chili pepper paste, and salt. Add shrimp, tossing to coat evenly. Cover, and microwave on High power for 5 minutes, or until shrimp is opaque, stirring after 3 minutes. Serve over hot cooked rice if desired.

Stuffed Mushrooms

1 pound whole baby bella mushrooms	2 tablespoons bread crumbs
2 tablespoons butter, melted	1 teaspoon lemon juice
1 bunch green onion, chopped	¼ teaspoon garlic pepper
¼ cup shredded Parmesan cheese	Crushed red pepper to taste

Remove stems from mushrooms and set aside. Arrange mushroom caps on microwave safe plate. Finely chop reserved mushroom stems. Combine butter, chopped mushroom stems, and green onion in a 1 quart microwave safe dish; microwave on High power for 2 minutes. Add remaining ingredients and mix well. Spoon stuffing into mushroom caps. Microwave on High power for 4 to 5 minutes, or until mushrooms are tender.

Asiago Red Potatoes

1 ¼ pound red potatoes, peeled and thinly sliced	1 ¼ cups milk
2 tablespoons all purpose flour	1 tablespoon butter, melted
½ teaspoon salt	5 ounces shredded Asiago cheese

Combine potatoes, flour, and salt in a zip top plastic bag; seal bag and shake to coat potatoes. Transfer potatoes to a lightly greased 2 quart microwave safe casserole dish. Add milk and butter, stirring well. Cover and microwave on High power for 12 minutes or until potatoes are tender; sprinkle with cheese and microwave on High power for an additional 5 minutes or until cheese melts.

Roasted Vegetables Medley

1 cup baby carrots	½ cup thinly sliced onion
1 cup sliced yellow squash	1 tablespoon butter
1 cup sliced zucchini	Garlic and herb seasoning to taste
½ cup sliced red bell pepper	

Combine carrots, squash, zucchini, bell pepper, and onion in a 2 quart microwave safe casserole dish. Dot with butter and sprinkle with seasoning. Cover, and microwave on High power for 5 minutes or to desired degree of doneness.

Spiced Pecans

4 tablespoons butter
1 tablespoon Creole seasoning
12 ounces pecan halves

Place butter in a 2 quart microwave safe dish; microwave on High power for 1 minute or until melted. Stir in Creole seasoning. Add pecans, tossing to coat evenly. Microwave on High power for 6 minutes, stirring after 3 minutes. Remove from microwave and spread out on paper towels to cool.

Baked Apples with Caramel

½ cup butter, melted	4 Granny Smith apples, cored
½ cup brown sugar	¼ cup chopped pecans
3 tablespoons whipping cream	

Combine butter, brown sugar, and whipping cream, mixing well. Arrange apples in 2 quart microwave safe casserole dish. Fill each apple with 1 tablespoon pecans and butter mixture. Spoon remaining mixture evenly over apples. Cover and microwave on High power for 5 minutes or until apples are tender. Remove from microwave and allow to stand 5 minutes. Serve with vanilla ice cream if desired.

Marinated Flank Steak

½ cup olive oil	1 tablespoon minced garlic
½ cup red wine vinegar	½ teaspoon black pepper
3 tablespoons fresh thyme	1 (2 pound) flank steak
2 tablespoons lemon juice	

Combine first 6 ingredients in a large zip top plastic bag, mixing well. Add steak to bag, turning to cover meat evenly. Squeeze air from bag and seal. Refrigerate steak overnight.

Remove steak from bag, discarding marinade. Place steak directly on metal platform rack and place on turntable in microwave. Convection roast at 375 for 35 minutes or to desired degree of doneness. Check internal temperature of the steak using an instant read hand held thermometer. Remove from microwave and allow to stand 5 minutes before slicing.

Savory Sweet Potatoes

2 sweet potatoes (about 1 ½ pounds), peeled and cut into 1 inch pieces
1 sweet onion, cut into 1 inch pieces
2 tablespoons extra virgin olive oil
1 teaspoon garlic-pepper blend
½ teaspoon salt

Combine all ingredients in a microwave safe 2 quart casserole, tossing to coat evenly. Cover with plastic wrap or lid to casserole. Microwave on High power for 8 minutes or until tender, stirring half way through cooking. Remove from microwave and let stand 2 minutes.

Yield: about 6 servings

Caring for Your Microwave Oven

In order to ensure that your microwave oven looks good and works well for a long time, you should maintain it properly. For proper care, please follow these instructions carefully.

For interior surfaces: Wash often with warm, sudsy water and a sponge or soft cloth.

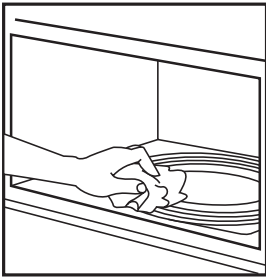

Use only mild, nonabrasive soaps or a mild detergent. Be sure to keep the areas clean where the door and oven frame touch when closed. Wipe well with clean cloth.

For exterior surfaces and control panel: The outside surface is

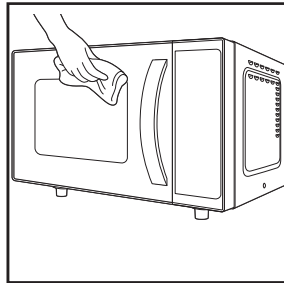

plastic and some models may have a Stainless Steel finish or coating. Clean the exterior with mild soap and water using a soft, clean sponge or cloth. Rinse with clean water and dry with a soft cloth. Do not scrub or use any sort of chemical cleaners, abrasive cleansers, steel wool pads, stainless steel cleaners, gritty wash cloths, some paper towels, etc. which can damage the control panel and exterior surfaces.

Over time, surfaces may stain as a result of food particles splattering during cooking. This is normal.

For stubborn soil: Boil a cup of water in the oven for two to three minutes. Steam will soften the soil. To get rid of odors inside the oven, boil a cup of water with some lemon juice or vinegar in it.

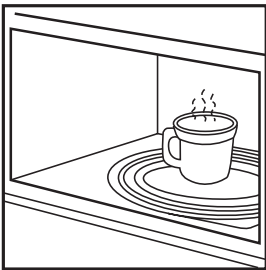

NOTE: Use the Clean option in Clock & Settings for a preset timed cycle for stubborn soil cleaning.

To clean glass turntable and turntable support: Wash

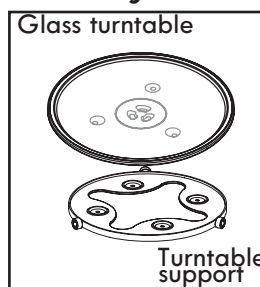

in mild, sudsy water. For heavily soiled areas, use a mild cleanser and scouring sponge. The glass turntable and turntable support are dishwasher safe.

CARING FOR THE FILTERS

The grease filters should be removed and cleaned often; at least once a month.

NOTE: Models are shipped for recirculating exhaust (To duct air outside reference the Installation Instructions book included with your microwave.). Some models have a disposable charcoal filter installed to help remove smoke and odors. Replacement filters are available from Sears by calling in the U.S.A. call 1-844-553-6667, and in Canada call 1-800-469-4663.. The charcoal filter cannot be cleaned and should be replaced every 6 to 12 months.

Grease filters (Part No. 5304488377)

1. Unplug microwave oven or disconnect power.
-
2. To remove grease filters, pull filter latch downward. The filter will drop out.

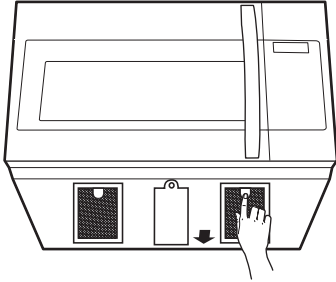

3. Soak grease filters in hot water and a mild detergent. Scrub and swish to remove embedded dirt and grease. Rinse well and shake to dry. Do not clean filters with ammonia, corrosive cleaning agents, such as lye-based oven cleaners, or place them in a dishwasher. The filters will turn black or become damaged.

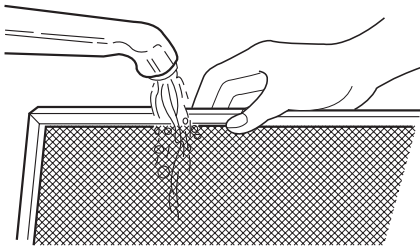

4. To replace grease filters, slide filter in the frame slot on back side of the opening. Push filter upward and lock into place.

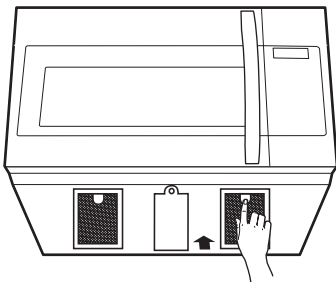

5. Plug in microwave oven or reconnect power.
- NOTE:** Do not operate the hood without the grease filters in place.

Charcoal filters (Part No. 5304488379)

1. Unplug microwave oven or disconnect power.
-
2. Open the microwave door and remove the two vent mounting screws located on top of the microwave using a #1 Phillips screwdriver.

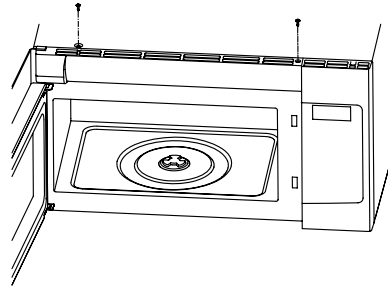

3. Slide the vent left and tip forward. Lift out to remove.

4. Install the charcoal filter. Lay the filter on the back of the grille with the black mesh face upper.

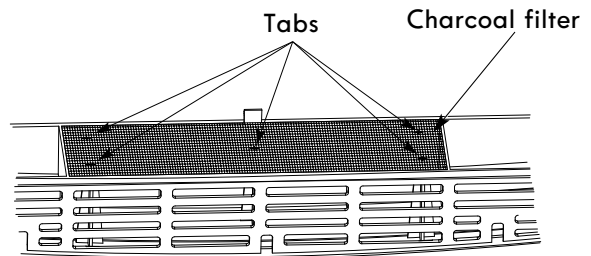

5. Reinstall the vent by sliding the bottom of the vent into place. Push the vent top into position and slide right into place. Replace the two vent mounting screws located on top of the microwave using a #1 Phillips screwdriver.

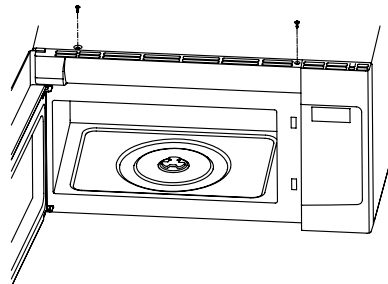

6. Close the microwave door. Plug in microwave oven or reconnect power.

REPLACING THE COOKTOP AND OVEN CAVITY LIGHTS

The cooktop lights

1. Unplug microwave oven or disconnect power.
2. Remove the bulb cover mounting screw for the specific bulb you want to replace.

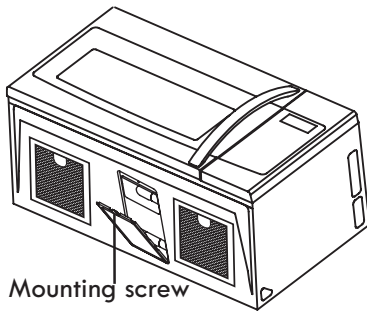

3. Replace bulb with candelabra-base 40-watt bulb (Part No. 5304488360) available from Sears by calling in the U.S.A. call 1-844-553-6667, and in Canada call 1-800-469-4663.
4. Plug in microwave oven or reconnect power.

The oven cavity light

1. Unplug microwave oven or disconnect power.
2. Open the microwave door and remove the two vent mounting screws located on top of the microwave using a #1 Phillips screwdriver.

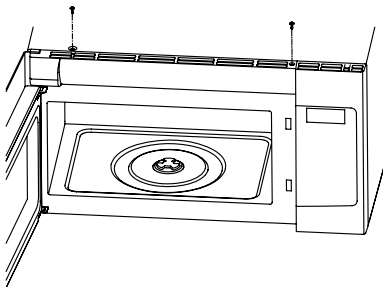

3. Lift the bottom of the charcoal filter. Slide the filter straight out.

4. Lift up the bulb holder.

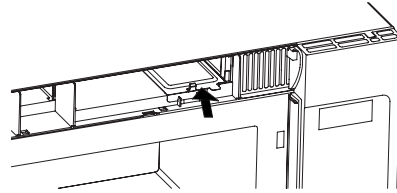

5. Replace the bulb with a candelabra-base 40-watt bulb (Part No. 5304488360) from Sears by calling in the U.S.A. call 1-844-553-6667, and in Canada call 1-800-469-4663.

6. Replace the bulb holder.

7. Reinstall the vent by sliding the bottom of the vent into place. Push the vent top into position and slide right into place. Replace the two vent mounting screws located on top of the microwave using a #1 Phillips screwdriver.

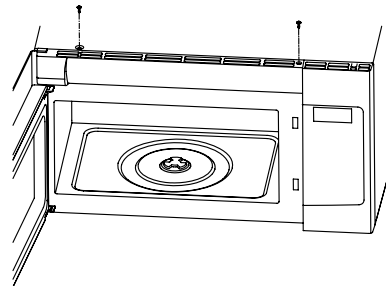

8. Close the microwave door. Plug in microwave oven or reconnect power.

Questions and Answers

QUESTIONS	ANSWERS
Can I operate my microwave oven without the glass turntable or turn the turntable over to hold a large dish?	No. If you remove or turn over the glass turntable, you will get poor cooking results.
Can I use either metal or aluminum pans in my microwave oven?	You can use aluminum foil for shielding (use small, flat pieces), small skewers, and shallow foil trays (if tray is no taller than 3/4 in. [1.9 cm] deep and is filled with food to absorb microwave energy). Never allow metal to touch walls or door.
Is it normal for the turntable to turn in either direction?	Yes. The turntable reverses rotation each time the microwave oven door is opened and closed. This helps cook food evenly.
Sometimes the door of my microwave oven appears wavy. Is this normal?	This appearance is normal and does not affect the operation of your oven.
What are the humming noises that I hear when my microwave oven is operating?	You may hear the sound of the transformer when the magnetron tube cycles on.
Why does the dish become hot when I microwave food in it? I thought that this should not happen.	As the food becomes hot it will conduct the heat to the dish. Be prepared to use hot pads to remove food after cooking.
What does "standing time" mean?	"Standing time" means that after the timed cooking period ends, food should be allowed to stand either inside or outside of the oven to completely finish cooking. Outside oven standing time will allow the oven to be available for other use. For inside oven standing time, you can program a "0" power second stage of the cooking cycle. See Two-Stage Cooking.
Why does steam come out of the air exhaust vent?	Steam is normally produced during cooking. The microwave oven has been designed to vent this steam.
Can I pop popcorn in my microwave oven?	Yes. Use the microwave oven popcorn selection. Do not use regular paper bags. Do not re-pop unpopped kernels. Do not pop popcorn in glass cookware. Remove the wire shelf from microwave oven when cooking popcorn.

Troubleshooting

Most cooking problems often are caused by little things that you can find and fix without tools of any kind. Check the lists below and on the next page before calling for assistance or service. If you still need help, call Sears Service in the U.S.A. call **1-844-553-6667**, and in Canada call **1-800-469-4663**.

MICROWAVE OVEN DOES NOT WORK

PROBLEM	CAUSE
Nothing works.	<ul style="list-style-type: none"> • The power supply cord is not plugged into a grounded 3 prong outlet. (See the "Electrical Requirements "and " Electrical Connection" sections.) • A household fuse has blown or a circuit breaker has tripped. • The electric company has had a power failure.
The microwave oven will not run.	<ul style="list-style-type: none"> • You are using the oven as a timer. Touch STOP to cancel the Kitchen Timer. • The door is not firmly closed and latched. • You did not touch START. • You did not follow directions exactly. • An operation that you set earlier is still running. Touch STOP to cancel that operation.

COOKING TIMES

PROBLEM	CAUSE
Food is not cooked enough.	<ul style="list-style-type: none"> • The electric supply to your home or wall outlets is low or lower than normal. Your electric company can tell you if the line voltage is low. Your electrician or service technician can tell you if the outlet voltage is low. • The cook power is not at the recommended setting. Check the Microwave Power Levels chart. • Refer to the Microwave Cooking Tips section.
The display shows a time counting down but the oven is not cooking.	<ul style="list-style-type: none"> • The oven door is not closed completely. • You have set the controls as a Kitchen Timer. Touch STOP to cancel the Kitchen Timer.

TURNTABLE

PROBLEM	CAUSE
The turntable will not turn.	<ul style="list-style-type: none"> • The turntable is not correctly in place. The glass plate should be correct-side up and sitting firmly on the center shaft. • The turntable has been set to OFF. • The hub is not operating correctly. Remove the turntable and restart the oven. If the hub still does not move, call Sears Service in the U.S.A. call 1-844-553-6667, and in Canada call 1-800-469-4663. Cooking without the turntable can give you poor results.

TONES

PROBLEM	CAUSE
You do not hear the programming or end-of-cycle tone.	<ul style="list-style-type: none"> • The sound has been set to OFF. See Turning Sound On/Off section.

Kenmore®

For Sears Home Services in-home repair
of all Kenmore major appliances.

For the replacement parts, accessories and
Use & Care Guides that you need to do-it-yourself.

For professional installation of major home appliances
and items like air conditioners and water heaters.

1-844-553-6667

www.kenmore.com

In Canada 1-800-469-4663

www.sears.ca

Call anytime for the location of your nearest
Sears Parts & Repair Service Center

1-800-488-1222 (U.S.A.)

1-800-469-4663 (Canada)

To purchase a protection agreement on a serviceable product :

1-800-827-6655 (U.S.A.)

1-800-361-6665 (Canada)

Para pedir servicio de reparación
a domicilio, y ordenar piezas:

1-888-SU-HOGAR®

(1-888-784-6427)

www.kenmore.com

Au Canada pour service en français:

1-800-LE-FOYER^{MC}

(1-800-533-6937)

www.sears.ca



Universal Keywords: Div22 Src628 Frigidaire Mechtech

Document Specific Keywords: Owner's Manual

Date: 012119

Document Name: 316495110en

Subject: Kenmore Src790 OTR Microwave Owner's Manual

Models: 790.83383710 790.80379310 790.8037931 790.80373310 790.8037331

790.80372310 790.8037231 79083383710 79080379310 7908037931 79080373310

7908037331 79080372310 7908037231 316495110

Free Manuals Download Website

<http://myh66.com>

<http://usermanuals.us>

<http://www.somanuals.com>

<http://www.4manuals.cc>

<http://www.manual-lib.com>

<http://www.404manual.com>

<http://www.luxmanual.com>

<http://aubethermostatmanual.com>

Golf course search by state

<http://golfingnear.com>

Email search by domain

<http://emailbydomain.com>

Auto manuals search

<http://auto.somanuals.com>

TV manuals search

<http://tv.somanuals.com>