



ULTRA WASH® Dishwasher

Use & Care Guide

Lavavajillas ULTRA WASH®

Manual de uso y cuidado

Lave-vaisselle ULTRA WASH®

Guide d'utilisation et d'entretien

Model/Modelo/Modèle 665.1379*

* = color number, número de color, numéro de couleur

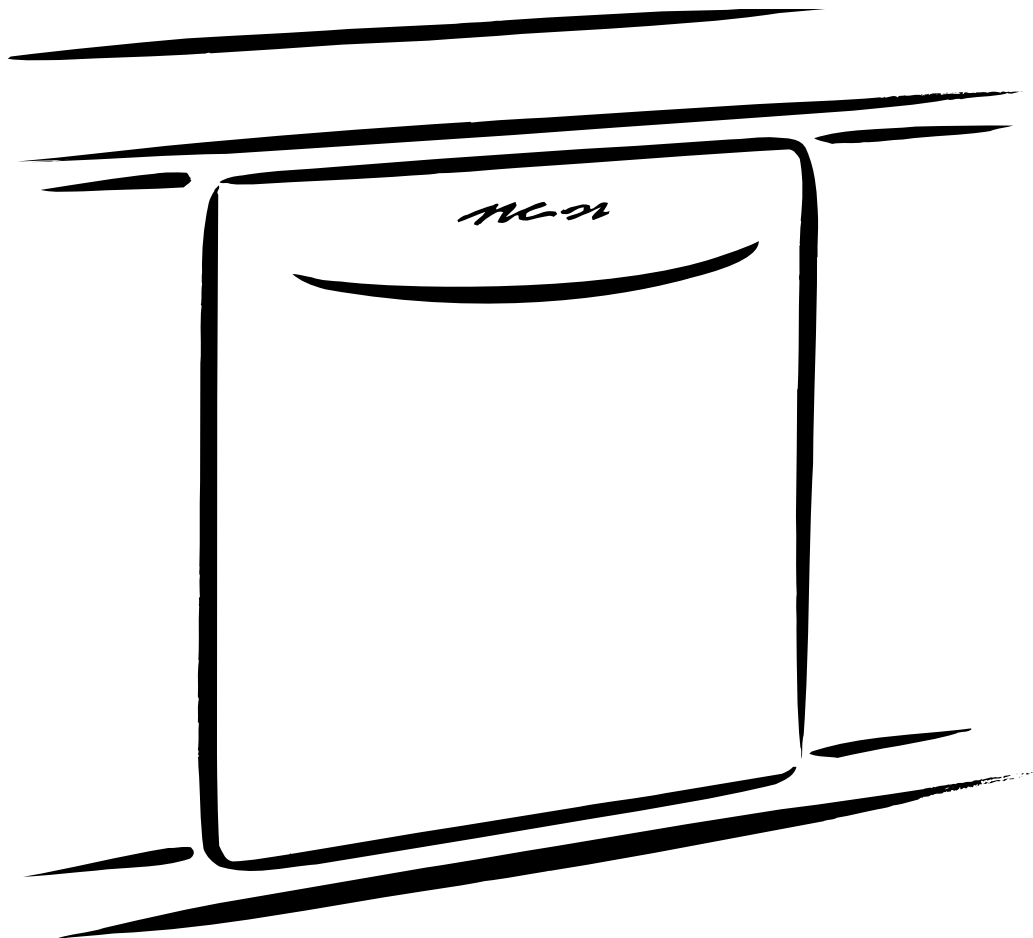

ENGLISH ESPAÑOL FRANÇAIS

TABLE OF CONTENTS

PROTECTION AGREEMENTS	2
In the U.S.A.....	2
In Canada	3
WARRANTY	3
DISHWASHER SAFETY	4
Before Using Your Dishwasher	5
PARTS AND FEATURES	6
Control Panel	7
ULTRA WASH® Soil Removal System	7
Featuring smartwash™ cycle and TURBOZONE™ wash option	7
START-UP GUIDE	8
Using Your New Dishwasher.....	8
DISHWASHER LOADING	8
Loading Suggestions.....	8
Loading Top Rack	9
Loading Bottom Rack	10
Loading Silverware Basket.....	12
DISHWASHER USE	13
Detergent Dispenser.....	13
Rinse Aid Dispenser	14
Dishwasher Efficiency Tips	14
Cycle Selection Charts.....	15
Canceling a Cycle.....	16
Changing a Cycle or Setting	16
Adding Items During a Cycle.....	16
Option Selections	16
Cycle Status Indicators	17
Active Vent.....	17
Overfill Protection Float	17
WASHING SPECIAL ITEMS	18
DISHWASHER CARE	19
Cleaning.....	19
Drain Air Gap	19
Storing	19
TROUBLESHOOTING	20
SERVICE NUMBERS	BACK COVER

PROTECTION AGREEMENTS

In the U.S.A.

Master Protection Agreements

Congratulations on making a smart purchase. Your new Kenmore® product is designed and manufactured for years of dependable operation. But like all products, it may require preventive maintenance or repair from time to time. That's when having a Master Protection Agreement can save you money and aggravation.

Purchase a Master Protection Agreement now and protect yourself from unexpected hassle and expense.

The Master Protection Agreement also helps extend the life of your new product. Here's what's included in the Agreement:

- ✓ **Expert service** by our 12,000 professional repair specialists
- ✓ **Unlimited service and no charge** for parts and labor on all covered repairs
- ✓ **"No-lemon" guarantee** – replacement of your covered product if four or more product failures occur within twelve months
- ✓ **Product replacement** if your covered product can't be fixed
- ✓ **Annual Preventive Maintenance Check** at your request – no extra charge
- ✓ **Fast help by phone** – phone support from a Sears technician on products requiring in-home repair, plus convenient repair scheduling
- ✓ **Power surge protection** against electrical damage due to power fluctuations
- ✓ **Rental reimbursement** if repair of your covered product takes longer than promised

Once you purchase the Agreement, a simple phone call is all that it takes for you to schedule service. You can call anytime day or night, or schedule a service appointment online.

Sears has over 12,000 professional repair specialists, who have access to over 4.5 million quality parts and accessories. That's the kind of professionalism you can count on to help prolong the life of your new purchase for years to come. Purchase your Master Protection Agreement today!

Some limitations and exclusions apply. For prices and additional information, call 1-800-827-6655.

Sears Installation Service

For Sears professional installation of home appliances, garage door openers, water heaters, and other major home items, in the U.S.A. call **1-800-4-MY-HOME®**.

Maintenance Agreements

Your purchase has added value because you can depend on Sears HomeCentral® for service. With over 2,400 Service Technicians and more than a million parts and accessories, we have the tools, parts, knowledge and skills to back our pledge: We Service What We Sell.

Your Kenmore® product is designed, manufactured and tested to provide years of dependable operation. But like all products, it may require service from time to time. The Sears Maintenance Agreement offers you an outstanding service program, affordably priced.

The Sears Maintenance Agreement

- Is your way to buy tomorrow's service at today's price
- Eliminates repair bills resulting from normal wear and tear
- Provides phone support from a Sears technician on products requiring in-home repair
- Even if you don't need repairs, provides an annual Preventive Maintenance Check, at your request, to ensure that your product is in proper running condition.

Some limitations apply. For more information about Sears Canada Maintenance Agreements, call 1-800-361-6665.

KENMORE ELITE® APPLIANCE WARRANTY

THREE-YEAR LIMITED WARRANTY ON THIS KENMORE ELITE® DISHWASHER

When installed, operated and maintained according to all instructions supplied with the product, if this appliance fails due to a defect in material or workmanship within three years from the date of purchase, call 1-800-4-MY-HOME® to arrange for free repair.

FIVE-YEAR LIMITED WARRANTY ON UPPER AND LOWER RACKS

For five years from the date of purchase, when this dishwasher is installed, operated and maintained according to all instructions supplied with the product, Sears will replace parts for the upper or lower dishrack if the rack rusts due to defective materials or workmanship. After the third year, customer assumes any labor costs associated with dishrack replacement.

LIMITED WARRANTY FOR THE LIFE OF THE DISHWASHER, ON KENMORE ELITE STAINLESS STEEL TUB MODELS, AGAINST LEAKS IN THE TUB AND INNER DOOR PANEL

For the life of the dishwasher, if a leak should occur as a result of rust-through of the stainless steel tub or inner door panel, Sears will replace the tub or inner door panel free of charge.

If this appliance is used for other than private family purposes, this warranty applies for only 90 days from the date of purchase.

THIS WARRANTY COVERS ONLY DEFECTS IN MATERIAL AND WORKMANSHIP. SEARS WILL NOT PAY FOR:

1. Expendable items that can wear out from normal use, including but not limited to filters, belts, light bulbs, and bags.
2. A service technician to instruct the user in correct product installation, operation or maintenance.
3. A service technician to clean or maintain this product.
4. Damage to or failure of this product if it is not installed, operated or maintained according to all instructions supplied with the product.
5. Damage to or failure of this product resulting from accident, abuse, misuse or use for other than its intended purpose.
6. Damage to or failure of this product caused by the use of detergents, cleaners, chemicals or utensils other than those recommended in all instructions supplied with the product.
7. Damage to or failure of parts or systems resulting from unauthorized modifications made to this product.

DISCLAIMER OF IMPLIED WARRANTIES; LIMITATION OF REMEDIES

Customer's sole and exclusive remedy under this limited warranty shall be product repair as provided herein. Implied warranties, including warranties of merchantability or fitness for a particular purpose, are limited to one year or the shortest period allowed by law. Sears shall not be liable for incidental or consequential damages. Some states and provinces do not allow the exclusion or limitation of incidental or consequential damages, or limitations on the duration of implied warranties of merchantability or fitness, so these exclusions or limitations may not apply to you.

This warranty applies only while this appliance is used in the United States and Canada.

This warranty gives you specific legal rights, and you may also have other rights which vary from state to state.

Sears, Roebuck and Co.
Dept. 817WA, Hoffman Estates, IL 60179
Sears Canada Inc.
Toronto, Ontario, Canada M5B 2B8

PRODUCT RECORD

In the space below, record your complete model number, serial number, and purchase date. You can find this information on the model and serial number label located on the product.

Have this information available to help you obtain assistance or service more quickly whenever you contact Sears concerning your appliance.

Model number _____

Serial number _____

Purchase date _____

Save these instructions and your sales receipt for future reference.

ENGLISH

DISHWASHER SAFETY

Your safety and the safety of others are very important.

We have provided many important safety messages in this manual and on your appliance. Always read and obey all safety messages.



This is the safety alert symbol.

This symbol alerts you to potential hazards that can kill or hurt you and others.

All safety messages will follow the safety alert symbol and either the word “DANGER” or “WARNING.” These words mean:

⚠ DANGER

You can be killed or seriously injured if you don't immediately follow instructions.

⚠ WARNING

You can be killed or seriously injured if you don't follow instructions.

All safety messages will tell you what the potential hazard is, tell you how to reduce the chance of injury, and tell you what can happen if the instructions are not followed.

IMPORTANT SAFETY INSTRUCTIONS

WARNING: When using the dishwasher, follow basic precautions, including the following:

- Read all instructions before using the dishwasher.
- Use the dishwasher only for its intended function.
- Use only detergents or rinse agents recommended for use in a dishwasher, and keep them out of the reach of children.
- When loading items to be washed:
 - 1) Locate sharp items so that they are not likely to damage the door seal; and
 - 2) Load sharp knives with the handles up to reduce the risk of cut-type injuries.
- Do not wash plastic items unless they are marked “dishwasher safe” or the equivalent. For plastic items not so marked, check the manufacturer's recommendations.
- Do not touch the heating element during or immediately after use.
- Do not operate the dishwasher unless all enclosure panels are properly in place.
- Do not tamper with controls.
- Do not abuse, sit on, or stand on the door, lid, or dish racks of the dishwasher.
- To reduce the risk of injury, do not allow children to play in or on the dishwasher.
- Under certain conditions, hydrogen gas may be produced in a hot water system that has not been used for two weeks or more. **HYDROGEN GAS IS EXPLOSIVE.** If the hot water system has not been used for such a period, before using the dishwasher turn on all hot water faucets and let the water flow from each for several minutes. This will release any accumulated hydrogen gas. As the gas is flammable, do not smoke or use an open flame during this time.
- Remove the door or lid to the washing compartment when removing an old dishwasher from service or discarding it.

SAVE THESE INSTRUCTIONS

Before Using Your Dishwasher

⚠ WARNING

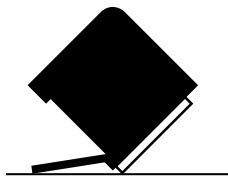

Tip Over Hazard

Do not use dishwasher until completely installed.

Do not push down on open door.

Doing so can result in serious injury or cuts.

⚠ WARNING



Electrical Shock Hazard

Electrically ground dishwasher.

Connect ground wire to green ground connector in terminal box.

Do not use an extension cord.

Failure to follow these instructions can result in death, fire, or electrical shock.

GROUNDING INSTRUCTIONS

■ **For a grounded, cord-connected dishwasher:**

The dishwasher must be grounded. In the event of a malfunction or breakdown, grounding will reduce the risk of electric shock by providing a path of least resistance for electric current. The dishwasher is equipped with a cord having an equipment-grounding conductor and a grounding plug. The plug must be plugged into an appropriate outlet that is installed and grounded in accordance with all local codes and ordinances.

WARNING: Improper connection of the equipment-grounding conductor can result in a risk of electric shock. Check with a qualified electrician or service representative if you are in doubt whether the dishwasher is properly grounded. Do not modify the plug provided with the dishwasher; if it will not fit the outlet, have a proper outlet installed by a qualified electrician.

■ **For a permanently connected dishwasher:**

The dishwasher must be connected to a grounded metal, permanent wiring system, or an equipment-grounding conductor must be run with the circuit conductors and connected to the equipment-grounding terminal or lead on the dishwasher.

SAVE THESE INSTRUCTIONS

- Install where dishwasher is protected from the elements. Protect against freezing to avoid possible rupture of fill valve. Such ruptures are not covered by the warranty. See "Storing" section for winter storage information.
- Install and level dishwasher on a floor that will hold the weight, and in an area suitable for its size and use.
- Remove all shipping plugs from hoses and connectors (such as the cap on the drain outlet) before installing. See Installation Instructions for complete information.

PARTS AND FEATURES

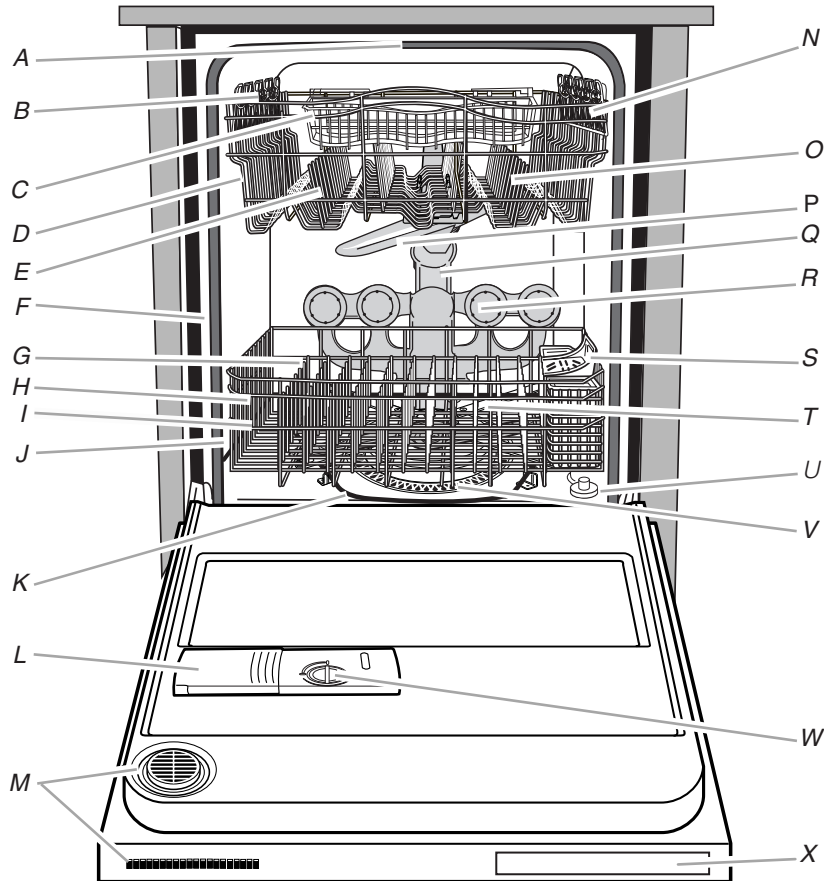

- A. Upper level wash
- B. Top rack adjusters (two)
- C. Utensil basket
- D. Removable top rack
- E. Flexible tines
- F. Model and serial number label
- G. Fold-down tines
- H. Knife holder (not shown)

- I. Bottom rack
- J. Water inlet opening (in tub wall)
- K. Heating element
- L. Detergent dispenser
- M. Active vent
- N. Cup shelves
- O. No-flip clips
- P. Top spray arm

- Q. ULTRA FLOW™ water feed tube
- R. TURBOZONE™ spray jets
- S. Silverware basket
- T. Lower spray arm
- U. Overfill protection float
- V. ULTRA WASH® module
- W. Rinse aid dispenser
- X. Control panel

Control Panel

Model 665.1379*

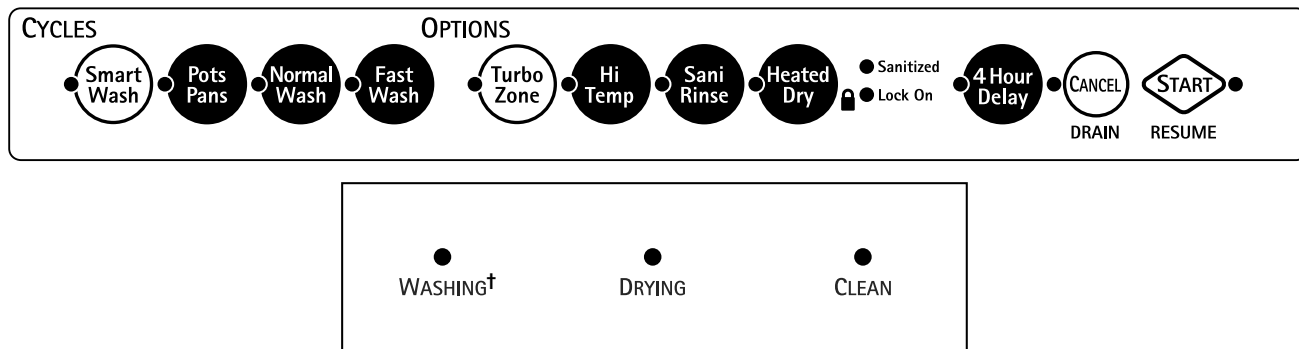

* = color number

† Status indicator light labels are not actually on dishwasher door front.

ULTRA WASH® Soil Removal System

The ULTRA WASH® Soil Removal System gives you sparkling clean dishes, while using less energy and time. The ULTRA WASH® Soil Removal System includes:

- A Triple Action Filtration system that intermittently filters soil from the wash water, thus eliminating the need to scrape dishes.

- An ULTRA WASH® optical soil sensor that detects soil level and detergent quantity appearing in the wash water and adjusts the cycles as needed.
- An Automatic Temperature Control (ATC) that ensures the proper water temperature for the selected wash cycle, dish load size, and soil level of the load.

Featuring smartwash™ cycle and TURBOZONE™ wash option

How the smartwash™ cycle works

When the smartwash™ cycle is selected, it saves energy and water by adjusting the wash cycle as needed.

- Sensors detect the size of the dish load, the soil level, and the water temperature in the dishwasher.
- Sensors automatically adjust the temperature and the amount of water used for the load.

This dishwasher will automatically calibrate the sensor approximately once a year to your water quality.

IMPORTANT: The very first wash cycle after installation in your home will be adjusted to include an additional 2 rinses for optical soil sensor calibration. For proper calibration, the first cycle should not be interrupted. If this calibration cycle is canceled or stopped before the Clean light comes on at the end of the cycle, the next wash cycle will repeat this sensor calibration.

How the TURBOZONE™ wash option works

When the TURBOZONE™ option is selected, it provides a concentrated wash to a specific zone in the back of the lower dishrack for large, hard-to-clean dishes.

- 4 rotating spray jets on the TURBOZONE™ manifold are periodically activated at the back of the tub throughout the wash cycle.
- Intensified cleaning is provided only to this specific wash area, allowing you to gently clean the rest of the dish load.

START-UP GUIDE

Before using your dishwasher, remove all packaging materials. Read this entire Use and Care Guide. You will find important safety information and useful operating tips.

Using Your New Dishwasher

1. Rinse aid is essential for good drying. Be sure to fill the dispenser before you use your new dishwasher. Each filling will last about 1 to 3 months depending on your usage.

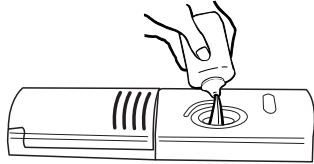

2. Scrape large food soil and hard items (toothpicks or bones) from dishes.
3. Properly load the dishwasher. (See “Dishwasher Loading.”) Load dishes with space in between so water will reach the soiled surfaces. Make sure nothing keeps the spray arm(s) from spinning freely.

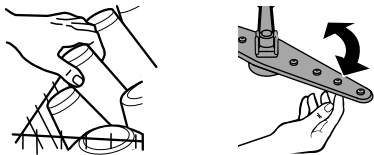

4. Add detergent. Always use a quality brand detergent. (See “Dishwasher Use.”)

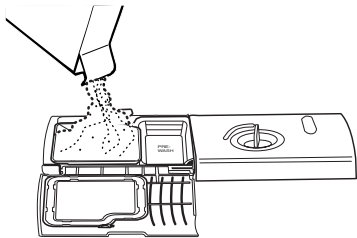

5. Run hot water at the sink nearest your dishwasher until the water is hot. (See “Dishwasher Efficiency Tips.”) Turn off water.

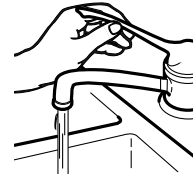

6. Press the desired cycle and option selections. (See “Dishwasher Use.”)

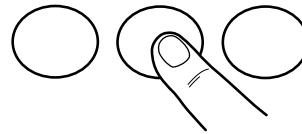

7. Press START/RESUME and firmly close the door. When door is firmly closed, it latches automatically. You can also press START/RESUME to repeat the same cycle and options as the previous cycle.

IMPORTANT: The Start/Resume light will flash if the door is opened during a cycle. Power interruptions during a cycle may also cause the Start/Resume light to flash. Press START/RESUME to continue a cycle.

NOTE: If the door is not closed within 3 seconds of pressing Start/Resume, press START/RESUME again.



DISHWASHER LOADING

Loading Suggestions

- Remove leftover food, bones, toothpicks and other hard items from the dishes. To conserve water and energy and save time, it is not necessary to rinse dishes before putting them into the dishwasher.
NOTE: Prerinsing dishes soiled with tomato-based products is recommended to avoid staining the dishware.
The wash module removes food particles from the water. The module contains a triple action filtration system that intermittently filters soil from the water.
NOTE: If hard items such as fruit seeds, nuts, and eggshells enter the wash module, you might hear grinding, crunching, or buzzing sounds. These sounds are normal when hard items enter the module. Do not let metallic items (such as pot handle screws) get into the wash module. Damage can occur.
- For best drying, water must be able to drain from all surfaces.
- It is important for the water spray to reach all soiled surfaces.
- Load dishes so they are not stacked or overlapping if possible.
- Use special care when loading heavy pots and pans. Heavy items can damage the interior of the door if they are dropped or bumped.
- Make sure pot lids and handles, pizza pans, cookie sheets, etc., do not interfere with the spray arm rotation.
- Conserve water and energy and save time over hand rinsing by running a rinse cycle to keep dishes moist if you do not plan to wash them soon. Foods such as eggs, rice, pasta, spinach, and cooked cereals may be hard to remove if they are left to dry over a period of time.

- Place items so open ends face down for best cleaning and draining.

Quiet operating tips

To avoid thumping/clattering noises during operation:

- Make sure lightweight load items are secured in the racks.
- Make sure pot lids and handles, pizza pans, cookie sheets, etc., do not touch interior walls or interfere with the rotation of the spray arm(s).
- Load dishes so they do not touch one another.

NOTE: For built-in models, keep sink drain plugs closed during dishwasher operation to avoid noise transfer through drains.

Loading Top Rack

The top rack is designed for cups, glasses, and smaller items. Many items, up to 11" (28 cm), fit in the top rack. (See recommended loading patterns shown.)

NOTE: The features on your dishwasher rack may vary from the drawings shown.

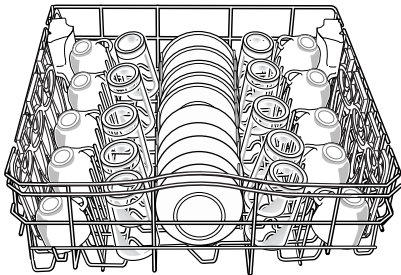

10 place setting

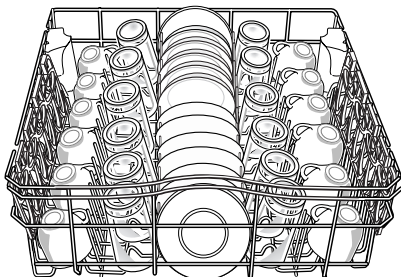

12 place setting

- Place items so open ends face down for cleaning and draining.
- Load glasses in top rack only. The bottom rack is not designed for glasses. Damage can occur.
- Place cups and glasses in the rows between tines. Placing them over the tines can lead to breakage and water spots.
- China, crystal, and other delicate items must not touch each other during dishwasher operation. Damage may occur.
- Load lightweight plastic items in the top rack only. Only plastic items marked "dishwasher safe" are recommended.
- Load plastic items so the force of the spray does not move them during the cycle.
- To avoid chipping, do not let stemware touch other items.
- Small bowls, pans, and other utensils can be placed in the top rack. Load bowls in the center section for best stability.

Utensil basket

Use this extra capacity basket in the back of the top rack to hold spatulas, wooden spoons, and similar items.

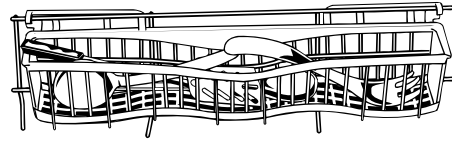

Cup shelves

Fold down the extra shelf on the left-hand or right-hand side of the top rack to hold additional cups, stemware or long items such as utensils and spatulas.

NOTE: The features on your dishwasher may vary from those shown below.

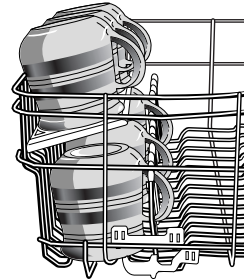

Deluxe adjustable 2-position top rack

You can raise or lower the top rack to fit tall items in either the top or bottom rack. Raise the top rack to accommodate items up to 9" (22 cm) in the top rack and 13" (33 cm) in the bottom rack, or lower the top rack to accommodate items up to 11" (28 cm) in both the top and bottom racks. Adjusters are located on each side of the top rack.

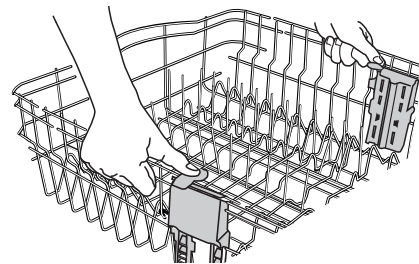

To raise the top rack

Lift the rack on both sides until the rack is level.

NOTE: The top rack must be level.

To lower the top rack

Depress both tabs on rack adjusters, as shown above, and slide the rack back to its original position.

Removable top rack

The removable top rack allows you to wash larger items such as stock pots, roasters, and cookie sheets in the bottom rack.

IMPORTANT: Remove dishes prior to removing the rack from the dishwasher.

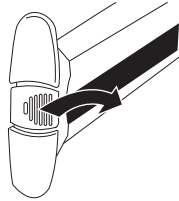

To remove the top rack

1. Pull the rack forward slightly to access clips.
2. While pressing the ridges in, push back on the clip until the outer side releases. Slide the clip to the inside of the track edge to remove the clip.
3. After removing both clips, pull rack out.

To replace the top rack

1. Place the rollers on each side of the rack into the rack tracks and push the rack back.
2. Align the open side of the clip with the inside edge of the rack track.
3. Push the ridges and slide the clip toward the outside rack edge until it locks into place.
4. Repeat on the other side.
5. Pull the rack out all of the way to ensure clips are fully seated.

Flexible tines

The row of tines on the left-hand and right-hand sides of the top rack can be adjusted to make room for a variety of dishes.

To adjust the left-hand side

1. Grasp the tip of the tine that is in the tine holder in the front of the rack.
2. Gently push the tine out of the holder.
3. Lay the tines down, toward the center of the rack.

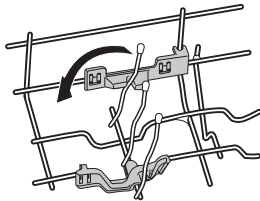

To adjust the right-hand side

1. Grasp the tip of the tine that is in the tine holder in the front of the rack.
2. Gently push the tine out of the tine holder.

3. Move the tines to the left to make room for larger dishes. Move the tines to the right to wedge plastic or other lightweight items against the side of the rack.

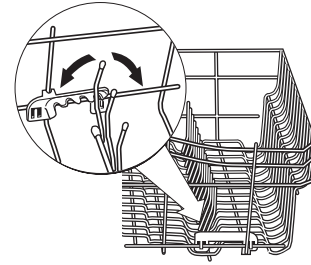

No-flip clips

The no-flip clips hold lightweight plastic items such as cups, lids, or bowls in place during washing.

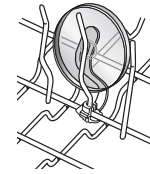

To move a clip

1. Pull the clip up and off the tine.
2. Reposition the clip on another tine.

Loading Bottom Rack

The bottom rack is designed for plates, pans, casseroles, and utensils. Many items, up to 13" (33 cm) tall, fit in the bottom rack. (See recommended loading patterns shown.)

NOTE: The features on your dishwasher rack may vary from the drawings shown.

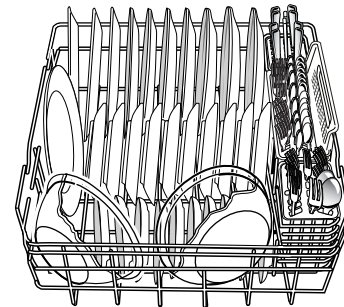

10 place setting

- Do not load glasses, cups, or lightweight plastic items in the bottom rack. Load small items in the bottom rack only if they are secured in place.
- Load plates, soup bowls, etc., between tines.
- Overlap the edges of plates for large loads.

- Load soup, cereal, and serving bowls in the rack in a variety of ways depending upon their size and shape. Load bowls securely between the rows of tines. Do not nest bowls because the spray will not reach all surfaces.

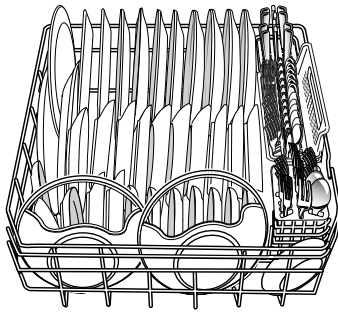

12 place setting

- Load cookie sheets, cake pans, and other large items at the sides and back. Loading such items in front can keep the water spray from reaching the detergent dispenser.
- Secure heavily soiled cookware face down in the rack. If using TURBOZONE™ wash option, load cookware in TURBOZONE™ wash area. (See “TURBOZONE™ wash area.”)
- Make sure pot handles and other items do not stop rotation of the spray arm(s). The spray arm(s) must move freely.
- Do not load items between the bottom rack and the side of the dishwasher tub because they might block the water inlet opening.

TURBOZONE™ wash area

The TURBOZONE™ wash area is located at the back of the lower dishrack.

NOTE: You must select the TURBOZONE™ wash option to utilize this wash feature. Do not face items toward the rear of the unit if you are not using this wash option.

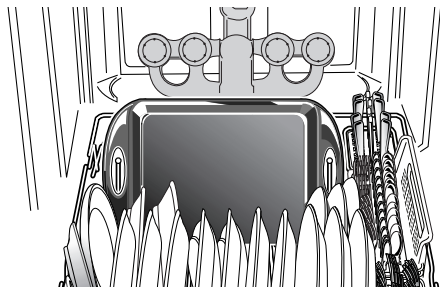

TURBOZONE™ wash area

- Load pans, casserole dishes, etc. in the back of the lower dishrack with the soiled surfaces facing the TURBOZONE™ spray jets. Make sure items do not interfere with the water feed tube, spray arms, or TURBOZONE™ spray jets.

- Tip items toward the rear of the unit between the back two rows of tines to maximize coverage.

IMPORTANT: Only one row of items may face the TURBOZONE™ spray jets. Load items so they do not interfere with the rotation of the TURBOZONE™ spray jets. Stacking, overlapping, or nesting items will keep the TURBOZONE™ spray jets from reaching all of the surfaces.

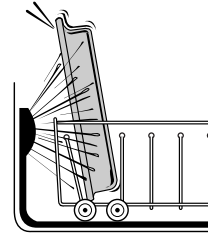

TURBOZONE™ wash area side view

Suggested 10 place setting loading patterns

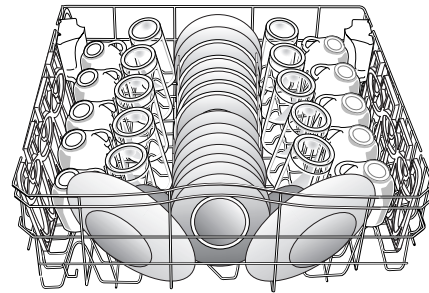

TURBOZONE™ 10 place setting top rack load

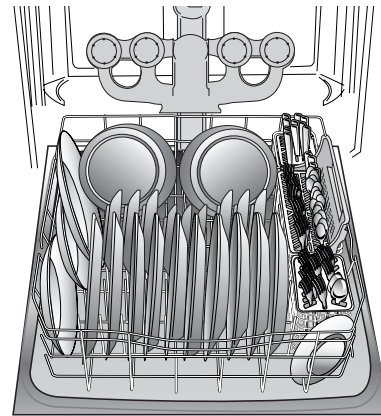

TURBOZONE™ 10 place setting bottom rack load

Fold-down tines

You can fold down one row of tines at the back of the bottom rack.

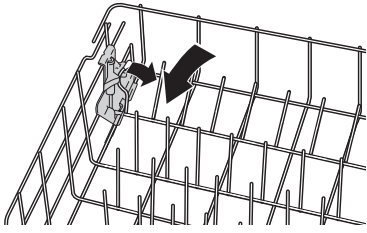

1. Grasp the tip of the tine that is in the tine holder.
2. Gently pull the tine out of the tine holder.
3. Lay the row of tines down in the rack to make room for larger dishes, bowls, pots, pans or roasters.

Knife holder

Use the knife holder on the left side of the bottom rack to hold knives that are too large for the silverware basket. Place knives in the holder as shown.

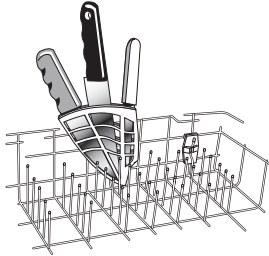

To remove the knife holder

1. Slide up to release the hooks over the rack wire.
2. Lift knife holder out of rack.

To install the knife holder

1. Align the knife holder with the bottom rack as shown in the illustration below.
2. Place the bottom slotted guide over the vertical wire in the side of the rack.
3. Place the hooks, located on the back of the knife holder, over the center rack wire and gently push down to lock into place.

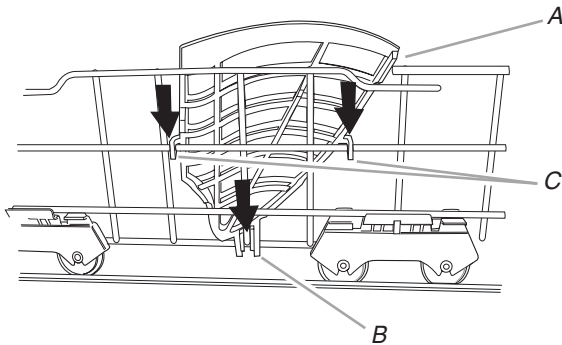

- A. Top alignment
B. Bottom slotted guide
C. Knife holder hooks

Loading Silverware Basket

Load the silverware basket while it is in the bottom rack or take the basket out for loading on a counter or table.

NOTE: Unload or remove the basket before unloading the racks to avoid spilling water droplets onto the silverware.

- Place small items such as baby bottle caps, jar lids, corncob holders, etc., in a covered section. Close the cover to hold small items in place.

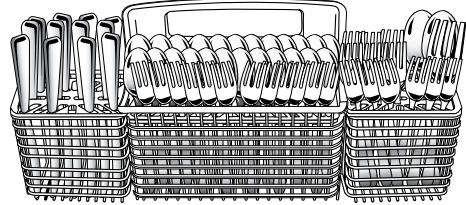

- Use suggested loading patterns, as shown, to increase washability of your silverware. Load items using the slots with the covers down to avoid silverware nesting.
- This silverware basket can be separated and placed into the bottom rack in several locations. Load silverware in all sections or just one, depending upon your load.
- If your silverware basket does not have covers or when covers are up, mix items in each section of the basket with some pointing up and some down to avoid nesting. Spray cannot reach nested items.

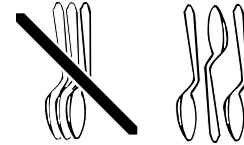

IMPORTANT: Always load items (knives, skewers, etc.) pointing down.

To remove a small basket

1. Hold the center basket and one small basket. Slide the small basket forward to release the tabs from the corresponding slots.

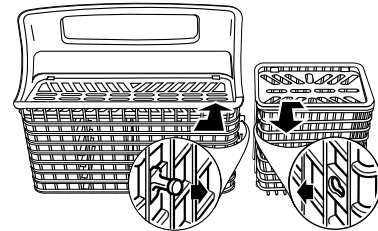

2. Pull the baskets apart.

NOTES:

- Do not load silver or silver-plated silverware with stainless steel. These metals can be damaged by contact with each other during washing.
- Some foods (such as salt, vinegar, milk products, fruit juices, etc.) can pit or corrode silverware. Run a rinse cycle if you do not have a full load to wash immediately.

DISHWASHER USE

Detergent Dispenser

The detergent dispenser has two sections. The smaller Pre-Wash section empties detergent into the dishwasher when you close the door. The larger Main Wash section automatically empties detergent into the dishwasher during the wash. (See the “Cycle Selection Charts.”)

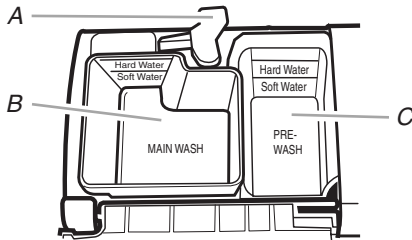

A. Cover latch
B. Main Wash section
C. Pre-Wash section

- Use automatic dishwashing detergent only. Other detergents can produce excessive suds that can overflow out of the dishwasher and reduce washing performance.
- Add detergent just before starting cycle.
- Store tightly closed detergent in a cool, dry place. Fresh automatic dishwasher detergent results in better cleaning.

NOTE: Do not use detergent with a Quick Rinse cycle.

Filling the dispenser

1. If the dispenser cover is closed, open the cover by moving the cover latch to the right.

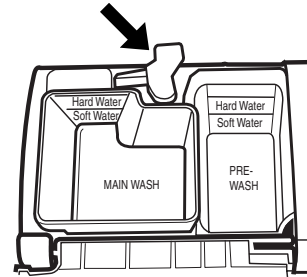

2. Add the correct amount of detergent to the Main Wash section of the dispenser according to the chart below. If you are using a tablet detergent, it must be placed in the Main Wash section. (See “How much detergent to use.”)
3. Add the correct amount of detergent to the Pre-Wash section of the dispenser, if needed, according to the chart below.
4. Close the dispenser cover and secure by pressing on the cover directly above the cover latch.

It is normal for the cover to open partially when dispensing detergent.

NOTE: See the “Cycle Selection Charts” for which section to fill depending on the cycle selected.

How much detergent to use

- The amount of detergent to use depends on the soil level of your dishes, hardness of your water, and the type of detergent. If you use too little, dishes will not be clean. If you use too much in soft water, glassware will etch.
- Water hardness can change over a period of time. Find out your water’s hardness by asking your Sears Sales Associate, local water department, water softener company, or county extension agent.

Detergent Dispenser fill recommendations per dish load soil level and water hardness						
Water Hardness	Light Soil or Prerinsed		Normal Soil		Heavy Soil	
	Main Wash section	Pre-Wash section	Main Wash section	Pre-Wash section	Main Wash section	Pre-Wash section
Soft (0-2 grains per U.S. gallon)	4 tsp (20 mL) Fill to Soft Water line	Empty	6 tsp (30 mL) Fill above the Soft Water line	2 tsp (10 mL) Fill to Soft Water line	9 tsp (45 mL) Fill cup completely	7 tsp (35 mL) Fill cup completely
Medium (2-6 grains per U.S. gallon)	6 tsp (30 mL) Fill above the Soft Water line	2 tsp (10 mL) Fill to Soft Water line	6 tsp (30 mL) Fill above the Soft Water line	4 tsp (20 mL) Fill to Hard Water line	9 tsp (45 mL) Fill cup completely	7 tsp (35 mL) Fill cup completely
Hard (7 grains per U.S. gallon and above)	8 tsp (40 mL) Fill to Hard Water line	4 tsp (20 mL) Fill to Hard Water line	9 tsp (45 mL) Fill cup completely	7 tsp (35 mL) Fill cup completely	9 tsp (45 mL) Fill cup completely	7 tsp (35 mL) Fill cup completely

NOTE: Fill amounts shown are for standard powdered detergent. Amounts may vary if you use liquid or concentrated powdered detergent. Tablet detergents should be placed in the main wash section of the detergent dispenser with the cover closed. Follow instructions on the package when using liquid dishwasher detergent, concentrated powdered detergent or tablet detergent.

Rinse Aid Dispenser

IMPORTANT: Your dishwasher is designed to use a liquid rinse aid. The use of rinse aids greatly improves drying by allowing water to drain from the dishes after the final rinse. They also keep water from forming droplets that can dry as spots or streaks. Do not use a solid or bar-type rinse aid.

Filling the dispenser

The rinse aid dispenser holds 5 oz (150 mL) of rinse aid. Under normal conditions, this will last for about 1 to 3 months.

1. Make sure the dishwasher door is fully open.
2. Turn the dispenser knob to “Open” and lift it out.

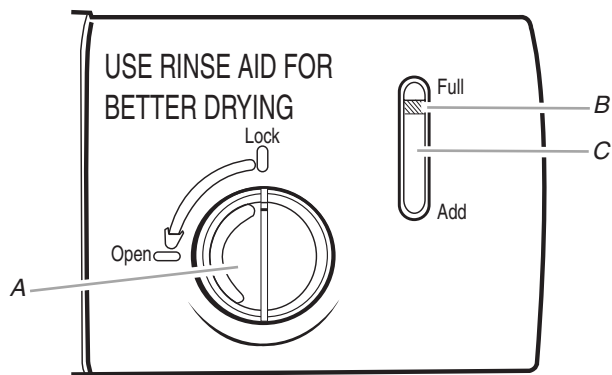

A. Dispenser knob
B. Indicator
C. Indicator window

3. Pour rinse aid into the opening until the indicator points to “Full.” Take care not to overfill. (When the rinse aid indicator drops to the “Add” level, add more rinse aid.)

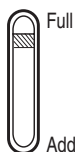

4. Clean up any spilled rinse aid with a damp cloth.
5. Place the knob back into the opening and turn to the “Lock” position.

Rinse aid setting

The amount of rinse aid released into the final rinse can be adjusted. For most water conditions, the factory setting of 2 will give good results. If you have hard water or notice rings or calcium spots on your glasses or dishes, try a higher setting.

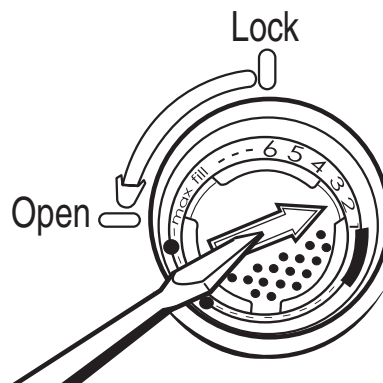

To adjust the setting

1. Remove the dispenser knob.
2. Turn the arrow adjuster inside the dispenser to the desired setting by either using your fingers or inserting a flat-blade screwdriver into the center of the arrow and turning.
3. Replace the dispenser knob.

Dishwasher Efficiency Tips

Hot water dissolves and activates the dishwashing detergent. Hot water also dissolves grease on dishes and helps glasses dry spot-free. For best dishwashing results, water should be 120°F (49°C) as it enters the dishwasher. Loads may not wash as well if the water temperature is too low. Water that is too hot can make some soils harder to remove and cause certain detergent ingredients not to function. If your water heater is located far from the dishwasher, it may be necessary to run the hot water at the faucet closest to the dishwasher to minimize the amount of cold water in the water line.

To check water temperature

1. Run hot water at the faucet closest to your dishwasher for at least 1 minute.
2. Place a candy or meat thermometer in a glass measuring cup.



3. Check the temperature on the thermometer as the water is running into the cup.

Additional efficiency tips

- To save water, energy and time, do not rinse dishes before putting them into the dishwasher.
- Use a delay feature to run your dishwasher during off-peak hours. Local utilities recommend avoiding heavy usage of energy at certain times of day.
- During the summer, run your dishwasher at night. This reduces daytime heat buildup in the kitchen.
- Use a rinse aid to improve drying.
- Use cycles or options that add extra heat to the wash or rinse portion of the cycle only when needed.
- If your home is equipped with a water softener, you may want to avoid starting the dishwasher during the regeneration of the softener, since this may contribute to poor wash performance.

Cycle Selection Charts

Select the wash cycle and options desired. Or press START/RESUME to use the same cycle and options as the previous cycle.

NOTE: If the last cycle you completed was a rinse cycle, the dishwasher will run the last full wash cycle and options that you selected when you press START/RESUME.

A "●" shows the steps that are in each cycle.

Water usage is shown in U.S. gallons/liters.

These models meet the ENERGY STAR® guidelines for energy efficiency.

Cycle time includes dry time. An asterisk (*) by the cycle time, Main Wash, and Final Rinse indicates the cycle time might be longer depending on the temperature of the water entering the dishwasher.

IMPORTANT: These sensor-based cycles may take several hours depending on cycle selected, water temperature, soil level, and dish mass sensed.

Pots Pans						
Use this cycle for heavily soiled pots, pans, casseroles, regular tableware and hard** water conditions.						
 Use both detergent dispenser sections.						
Pre-Wash	Main Wash*	Pre-Rinse†	Final Rinse*	Dry	Average Time* (min)	Water Usage (gal/L)
●	● 140°F (60°C)	●	● 140°F (60°C)	●	125*	6.9-7.8/ 26-30

Normal Wash						
Use this cycle for loads with normal amounts of food soil. (The energy-usage label is based on this cycle.) During the wash cycle, the wash action will repeatedly pause for several seconds.						
 Use both detergent dispenser sections.						
Pre-Wash	Main Wash*	Pre-Rinse†	Final Rinse*	Dry	Average Time* (min)	Water Usage (gal/L)
●	● 115°F (46°C)	●	● 140°F (60°C)	●	110*	4.3-7.8/ 16-30



Fast Wash						
Use this cycle for a quick wash to clean dishes prior to entertaining. Towel drying may be needed. This cycle takes exactly 30 minutes.						
 Use main detergent dispenser section.						
Pre-Wash	Main Wash	Pre-Rinse†	Final Rinse	Dry	Time (min)	Water Usage (gal/L)
●	●	●	●		30	6.9/26

†A small amount of water is run through the pump to remove soil particles between the main wash and final rinse.

*If the incoming water temperature is less than the recommended temperature or food soils are heavy, the cycle will automatically compensate by adding time, heat, and water as needed.

**Hard water is defined as 7 grains per U.S. gallon and above.

NOTE: The sensor in your dishwasher monitors the soil level. Cycle time and/or water usage can vary from the numbers above as the sensor adjusts the cycle for the best wash performance.

Smart Wash								
Use this cycle for all day-to-day soil types when washing full to partial dish loads. During the cycle, the sensors will determine water temperature, wash time, and water amount based on the soil level and the dish load size. During the main wash, the wash action will repeatedly pause for several seconds.								
 Use both detergent dispenser sections when washing a full soiled dish load.								
 Use one detergent dispenser section when washing lightly soiled, partial dish loads.								
Dish load	Soil Level Sensed	Pre-Wash	Main Wash*	Rinse or Purge †	Final Rinse*	Dry	Average Time* (min)	Water Usage (gal/L)
Full	Heavy	●	● 145°F (63°C)	● Rinse	● 140°F (60°C)	●	145*	6.6-7.5/ 25.0-28.4
	Nominal	●	● 119°F (48°C)	● Purge	● 140°F (60°C)	●	115*	5.6/21.2
	Light		● 115°F (46°C)	● Purge	● 140°F (60°C)	●	105*	4.3/16.3
Partial	Heavy	●	● 145°F (63°C)	● Purge	● 140°F (60°C)	●	130*	5.6-6.5/ 21.2-24.6
	Nominal	●	● 119°F (48°C)	● Purge	● 140°F (60°C)	●	105*	5.6/21.2
	Light		● 115°F (46°C)	● Purge	● 140°F (60°C)	●	105*	4.3/16.3

Canceling a Cycle

1. Open the door slightly to stop the cycle. Wait for the spraying action to stop before opening the door to access the control panel.
2. Press CANCEL/DRAIN. The Cancel light glows.
3. Close the door. The dishwasher starts a 2-minute drain (if needed). Let the dishwasher drain completely. The light turns off after 2 minutes.

To stop the drain

You can press CANCEL/DRAIN again to stop the drain. Remember to drain the dishwasher before starting a new cycle.

To clear the indicators

Press CANCEL/DRAIN before starting the dishwasher to clear all options and cycles.

Changing a Cycle or Setting

During the first minute of a cycle

1. Open the door. The Start/Resume light begins flashing.
2. Press a new cycle and/or options.
3. Check the detergent dispensers. They must be filled properly for the new cycle.
4. Press START/RESUME and firmly close the door.

After the first minute of a cycle

1. Open the door slightly to stop the cycle. Wait for the spraying action to stop before opening the door to access the control panel.
2. Press CANCEL/DRAIN. The Cancel light glows.
3. Close the door. Your dishwasher starts a 2-minute drain (if needed). Let the dishwasher drain completely. The light turns off after 2 minutes.

NOTE: If your dishwasher does not need draining, the light turns off.

4. Open the door. Select a new cycle and/or options.
5. Check the detergent dispensers. They must be filled properly for the new cycle.
6. Press START/RESUME and firmly close the door.

NOTE: If the door is not closed within 3 seconds of pressing Start/Resume, press START/RESUME again.

Adding Items During a Cycle

You can add an item anytime before the main wash starts. Open the door and check the detergent dispenser. If the cover is still closed, you can add items.

To add items

1. Open the door slightly to stop the cycle. Wait for the spraying action to stop before opening the door. The Start light begins flashing.
2. Open the door. If the detergent dispenser cover is still closed, add the item.
3. Press START/RESUME and firmly close the door.

NOTE: If the door is not closed within 3 seconds of pressing Start/Resume, press START/RESUME again.

Option Selections

You can customize your cycles by pressing an option. If you change your mind, press the option again to turn the option off, or select a different option if desired.

You can change an option anytime before the selected option begins. For example, you can press an unheated drying option anytime before drying begins.

Press START/RESUME to use the same cycle and option(s) as the previous wash cycle.

NOTE: If the last cycle you completed was a rinse cycle, when you press START/RESUME, the dishwasher runs the last full wash cycle and options.

TURBOZONE™ wash option

Select this option to activate the TURBOZONE™ spray jets and provide intensified water spray to the back of the lower dishrack. The TURBOZONE™ wash option provides a concentrated wash action to pans, casseroles, etc. with tough food soil.

This option may add heat and wash time to the cycle.

NOTE: TURBOZONE™ is an option with the SMART WASH™, Pots Pans, and Normal Wash cycles.

IMPORTANT:

- Load pans, casserole dishes, etc. facing the TURBOZONE™ spray jets in the back of the lower dishrack. Tip items toward the rear of the dishrack to maximize coverage. Only one row of items may face the TURBOZONE™ spray jets. Stacking, overlapping, or nesting items will keep the TURBOZONE™ spray jets from reaching all of the surfaces.
- To maximize spray coverage, avoid placing silverware basket or other items to interfere with the rotation of the TURBOZONE™ spray jets.
- Turn the TURBOZONE™ wash option off if not loading items for this option. Always use the Heavy Soil detergent fill recommendation with TURBOZONE™ wash option. (See "How much detergent to use" in "Detergent Dispenser" section.)

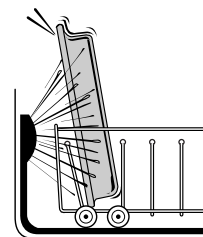

Side view of TURBOZONE™ wash area

Hi Temp

Select this option to increase the water temperature during the wash portions of the cycle. Hi Temp wash raises the water temperature to 145°F (63°C), in the main wash. Heating the water helps improve washing results. Hi Temp wash is useful when loads contain tough food soil.

This option may add heat and wash time to the cycle.

NOTE: Hi Temp wash is an option with the SMART WASH™, Pots Pans, and Normal Wash cycles.

Sani Rinse

Select this option to raise the water temperature in the final rinse to approximately 155°F (68°C). Sani Rinse adds heat and time to the cycle. This high temperature rinse sanitizes your dishes and glassware in accordance with NSF/ANSI Standard 184 for Residential Dishwashers. Certified residential dishwashers are not intended for licensed food establishments.

NOTE: Sani Rinse is an option with SMART WASH™, Pots Pans, and Normal Wash cycles. Only these sanitization cycles have been designed to meet the NSF/ANSI requirements.

Heated Dry

The Heated Dry option in combination with rinse aid will give you excellent drying results. The energy to use Heated Dry costs pennies per cycle. Heated Dry is on when the light is lit on the Heated Dry button. Be sure to load plastic items in the upper rack to avoid damage.

You may turn off the Heated Dry option by pressing HEATED DRY so that the light goes off. However, you will have items in your dishload that will not be dry at the end of the cycle.

NOTE: The Heated Dry option is used in all cycles except Fast Wash and Quick Rinse.

Lock On

Use the Lock On to prevent unintended use of the dishwasher between cycles.

When Lock On is lit, all buttons are disabled.

NOTE: The dishwasher door can be opened while the controls are locked.

To turn on the Lock

Press and hold HEATED DRY for 4 seconds. Lock On glows.

If you press any pad while your dishwasher is locked, the light flashes 3 times.

NOTE: If the Heated Dry option is selected, the light will temporarily turn off until Lock On glows.

To turn off the Lock

Press and hold HEATED DRY for 4 seconds. The light turns off.

4 Hour Delay

Select this option to run your dishwasher at a later time or during off-peak hours. You can add items to the load anytime during the delay. After adding items, press START/RESUME. Make sure the door is latched or the delay will not continue.

To delay the start

1. Press the delay button to choose the number of hours delayed.
2. Select a wash cycle and options.
3. Press START/RESUME.

The dishwasher starts the cycle in the selected number of hours.

NOTES:

- To cancel the delay and cycle, press CANCEL/DRAIN.
 - To cancel the delay and start the cycle, press START/RESUME.
 - If the door is not closed within 3 seconds of pressing Start/Resume, press START/RESUME again.
-

Cycle Status Indicators

Follow the progress of your dishwasher with the Cycle Status indicators.



Clean

Clean glows when a cycle is finished. The light turns off when you press any button or close the door.

Sanitized

If you select the Sani Rinse option, Sanitized glows when the Sani Rinse cycle is finished. If your dishwasher did not properly sanitize your dishes, the light flashes at the end of the cycle. This can happen if the cycle is interrupted or the incoming water temperature is too low. The light turns off when you press any button or close the door.

Active Vent

The active vent reduces the filling and washing sounds from your dishwasher. The vent closes, after the cycle starts, to lock in sound. After the cycle finishes and the dishes cool for several hours, the vent opens. This keeps any water vapor from collecting on the countertop. Between cycles, the vent stays open for airflow, reducing the buildup of odors.

NOTE: There is a slight noise when the vent closes or opens. This is normal.

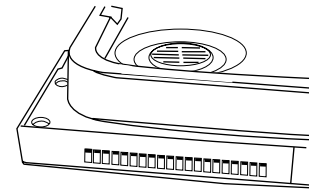

Overfill Protection Float

The overfill protection float (in the front right corner of the dishwasher tub) keeps the dishwasher from overflowing. It must be in place for the dishwasher to operate.

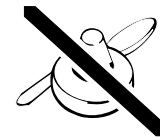

Check under the float for objects that may keep the protector from moving up or down.

WASHING SPECIAL ITEMS

If you have doubts about washing a particular item, check with the manufacturer to see if it is dishwasher safe.

Material	Dishwasher Safe?/Comments
Aluminum	Yes High water temperature and detergents can affect finish of anodized aluminum.
Disposable Aluminum	No Do not wash throwaway aluminum pans in the dishwasher. These might shift during washing and transfer black marks to dishes and other items.
Bottles and Cans	No Wash bottles and cans by hand. Labels attached with glue can loosen and clog the spray arms or pump and reduce washing performance.
Cast Iron	No Seasoning will be removed, and iron will rust.
China/Stoneware	Yes Always check manufacturer's recommendations before washing. Antique, hand-painted, or over-the-glaze patterns may fade. Gold leaf can discolor or fade.
Crystal	Yes Always check manufacturer's recommendations before washing. Some types of leaded crystal can etch with repeated washing.
Gold	No Gold-colored flatware will discolor.
Glass	Yes Milk glass yellows with repeated dishwasher washing.
Hollow-Handle Knives	No Handles of some knives are attached to the blade with adhesives which can loosen if washed in the dishwasher.

Material	Dishwasher Safe?/Comments
Pewter, Brass, Bronze	No High water temperatures and detergent can discolor or pit the finish.
Disposable Plastics	No Cannot withstand high water temperatures and detergents.
Plastics	Yes Always check manufacturer's recommendations before washing. Plastic items may vary in their ability to withstand high temperatures and detergents. It is recommended that light items such as lids and butter dishes be placed in the upper rack only. Sturdy items such as coolers and high-chair trays may be placed in the lower rack. When washing plastic items in the lower rack, it is recommended that an air dry be used.
Stainless Steel	Yes Run a rinse cycle if not washing immediately. Prolonged contact with food containing salt, vinegar, milk products, or fruit juice can damage finish.
Sterling Silver or Silver Plate	Yes Run a rinse cycle if not washing immediately. Prolonged contact with food containing salt, acid, or sulfide (eggs, mayonnaise, and seafood) can damage finish.
Tin	No Can rust.
Wooden Ware	No Wash by hand. Always check manufacturer's instructions before washing. Untreated wood can warp, crack, or lose its finish.

DISHWASHER CARE

Cleaning

Cleaning the exterior

In most cases, regular use of a soft, damp cloth or sponge and a mild detergent is all that is necessary to keep the outside of your dishwasher looking nice and clean. If your dishwasher has a stainless steel exterior, a stainless steel cleaner is recommended.

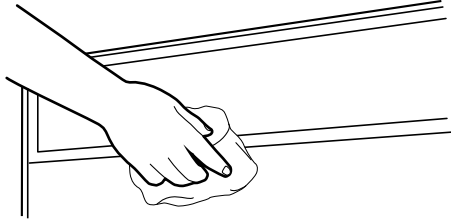

Cleaning the interior

Hard water minerals can cause a white film to build up on the inside surfaces, especially just beneath the door area.

Do not clean the dishwasher interior until it has cooled. Wear rubber gloves. Do not use any type of cleanser other than dishwasher detergent because it may cause foaming or sudsing.

To clean interior

Make a paste with powdered dishwasher detergent on a damp sponge and clean.

OR

Use liquid automatic dishwasher detergent and clean with a damp sponge.

OR

See the vinegar rinse procedure in "Spotting and filming on dishes" in "Troubleshooting."

NOTE: Run a normal cycle with detergent after cleaning the interior.

Drain Air Gap

Check the drain air gap anytime your dishwasher isn't draining well.

Some state or local plumbing codes require the addition of a drain air gap between a built-in dishwasher and the home drain system. If a house drain is clogged, the drain air gap protects your dishwasher from water backing up into it.

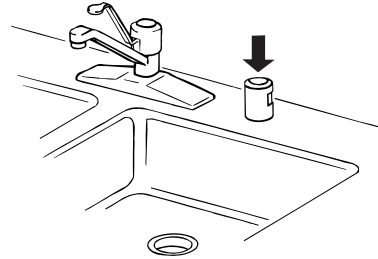

The drain air gap is usually located on top of the sink or countertop near the dishwasher. To order a drain air gap, please call **1-800-4-MY-HOME®**. Ask for Part Number 300096.

NOTE: The drain air gap is an external plumbing device that is not part of your dishwasher. The warranty provided with your dishwasher does not cover service costs directly associated with the cleaning or repair of the external drain air gap.

To clean the drain air gap

Clean the drain air gap periodically to ensure proper drainage of your dishwasher. Follow the cleaning instructions provided by the manufacturer. With most types, you lift off the chrome cover. Unscrew the plastic cap. Then check for any soil buildup. Clean if necessary.

Storing

Storing for the summer

Protect your dishwasher during the summer months by turning off the water supply and power supply to the dishwasher.

Winterizing your dishwasher

Protect your dishwasher and home against water damage due to freezing water lines. If your dishwasher is left in a seasonal dwelling or could be exposed to near freezing temperatures, have your dishwasher winterized by authorized service personnel.

TROUBLESHOOTING

First try the solutions suggested here and possibly avoid the cost of a service call...

Dishwasher is not operating properly

■ Dishwasher does not run or stops during a cycle

Is the door closed tightly and latched?

Is the right cycle selected? Refer to the “Cycle Selection Charts.”

Is there power to the dishwasher? Has a household fuse blown, or has a circuit breaker tripped? Replace the fuse or reset the circuit breaker. If the problem continues, call an electrician.

Has the motor stopped due to an overload? The motor automatically resets itself within a few minutes. If it does not restart, call for service.

Is the water shutoff valve (if installed) turned on?

It is normal for certain cycles to repeatedly pause for several seconds during the wash cycle.

■ START/RESUME light is flashing

Was the door opened during the cycle, or was the power interrupted? The Start/Resume light will flash when the door is opened during a cycle, or may flash if the power is interrupted. Press START/RESUME to resume the cycle. Make sure the door is fully closed and latched.

NOTE: On top control models, if the door is not closed within 3 seconds of pressing Start/Resume, press START/RESUME again.

■ Clean light is flashing

The dishwasher has malfunctioned. Call for service.

■ Dishwasher will not fill

Is the overflow protection float able to move up and down freely? Press down to release.

■ Dishwasher seems to run too long

Is the water supplied to the dishwasher hot enough? The dishwasher runs longer while heating water. Refer to the “Dishwasher Efficiency Tips” section.

A delay automatically occurs in some wash and rinse cycles until the water reaches the proper temperature.

■ Water remains in the dishwasher

Is the cycle complete?

Was the disposer knockout plug removed during installation? (See “Install the drain hose” in the Installation Instructions.)

■ Detergent remains in the covered section of the dispenser

Is the cycle complete?

Is the detergent lump-free? Replace detergent if necessary.

Is the bottom rack installed properly with the bumpers (on some models) in the front? Refer to the “Parts and Features” section. Reinstall the rack if necessary.

■ White residue on the front of the access panel

Was too much detergent used? Refer to the “Detergent Dispenser” section.

Is the brand of detergent making excess foam? Try a different brand to reduce foaming and eliminate buildup.

■ Odor in the dishwasher

Are dishes washed only every 2 or 3 days? Run a rinse cycle once or twice a day until you have a full load.

Does the dishwasher have a new plastic smell? Run a vinegar rinse as described in the section “Spotting and filming on dishes.”

■ Condensation on the kitchen counter (built-in models)

Is the dishwasher aligned with the countertop? Moisture from the vent in the dishwasher console can form on the counter. Refer to the Installation Instructions for more information.

■ Bottom rack does not fully slide into the dishwasher

Check to see if items loaded for TURBOZONE™ wash option have shifted. Reload to keep items from interfering with spray jets or spray arm. (See “Loading Bottom Rack.”)

Dishes are not completely clean

■ Food soil left on the dishes

Is the dishwasher loaded correctly? Refer to the “Dishwasher Loading” section.

Is the water temperature too low? For best dishwashing results, water should be 120°F (49°C) as it enters the dishwasher. Refer to the “Dishwasher Efficiency Tips” section.

Did you use the correct amount of fresh detergent? Use recommended dishwasher detergents only. Refer to the “Detergent Dispenser” section. Detergent must be fresh to be effective. Store detergent in a cool, dry area. Heavy soil and/or hard water generally require extra detergent.

Do you have hard water? You may need to increase the amount of detergent you are using. Refer to the “Detergent Dispenser” section. Also, you may need to switch to a detergent with a phosphorus content of 8.7%.

Is detergent caked in dispenser? Use fresh detergent only. Do not allow detergent to sit for several hours in a wet dispenser. Clean dispenser when caked detergent is present.

Is the pump or spray arm clogged by labels from bottles and cans?

Is the home water pressure high enough for proper dishwasher filling? Home water pressure should be 20 to 120 psi (138 to 828 kPa) for proper dishwasher fill. If you have questions about your water pressure, call a licensed, qualified plumber.

Are high suds slowing the wash arm? Do not use soap or laundry detergents. Use recommended dishwasher detergents only.

■ Dishes in the TURBOZONE™ wash area are not clean

Are the dishes loaded to face the TURBOZONE™ spray jets? Load soiled dish surfaces to face the back of the dishwasher toward the TURBOZONE™ spray jets. Tilt the dishes toward the back so water can drain from surfaces, and the lower spray arm can wash the item from below.

NOTE: Loaded items may shift when dishracks are pushed into the dishwasher. Make sure dishes do not interfere with the spray arms, water feed tube, or TURBOZONE™ spray jets.

Are items loaded so they do not overlap? Load items only one row deep without any overlap so that the TURBOZONE™ spray jets can reach all surfaces.

Are the TURBOZONE™ spray jets free to rotate? Make sure that no loaded items are interfering with the spray jets' rotation.

Spots and stains on dishes

■ Spotting and filming on dishes

Is your water hard or is there a high mineral content in your water? Conditioning the final rinse water with a liquid rinse aid helps eliminate spotting and filming. Keep the rinse aid dispenser filled.

Is the water temperature too low? For best dishwashing results, water should be 120°F (49°C) as it enters the dishwasher. Refer to the “Dishwasher Efficiency Tips” section.

Did you use the correct amount of effective detergent? Use recommended dishwasher detergents only. Refer to the “Detergent Dispenser” section. Detergent must be fresh to be effective. Store detergent in a cool, dry area. Heavy soil and/or hard water generally require extra detergent.

Is the home water pressure high enough for proper dishwasher filling? Home water pressure should be 20 to 120 psi (138 to 828 kPa) for proper dishwasher fill. If you have questions about your water pressure, call a licensed, qualified plumber.

NOTE: To remove spots and film from dishes, try a white vinegar rinse. This procedure is intended for occasional use only. Vinegar is an acid, and using it too often could damage your dishwasher.

1. Wash and rinse dishes. Use an air-dry or an energy saving dry option. Remove all silverware or metal items.
2. Put 2 cups (500 mL) white vinegar in a glass or dishwasher-safe measuring cup on the bottom rack.
3. Run the dishwasher through a complete washing cycle using an air-dry option. Do not use detergent. Vinegar will mix with the wash water.

■ Silica film or etching (silica film is a milky, rainbow-colored deposit; etching is a cloudy film)

Sometimes there is a water/chemical reaction with certain types of glassware. This is usually caused by some combination of soft or softened water, alkaline washing solutions, insufficient rinsing, overloading the dishwasher, and the heat of drying. It might not be possible to avoid the problem, except by hand washing.

To slow this process use a minimum amount of detergent per load. Refer to the “Detergent Dispenser” section. Use a liquid rinse aid and underload the dishwasher to allow thorough rinsing. Silica film and etching are permanent and cannot be removed. Do not use heated drying.

■ White spots on cookware with nonstick finish

Has the dishwasher detergent removed cookware seasoning? Reseason cookware after washing in the dishwasher.

■ Brown stains on dishes and dishwasher interior

Does your water have high iron content? Rewash dishes using 1-3 tsp (5-15 mL) of citric acid crystals added to the covered section of the detergent dispenser. Do not use detergent. Follow with a Normal wash cycle with detergent. If treatment is needed more often than every other month, the installation of an iron removal unit is recommended.

■ Black or gray marks on dishes

Are aluminum items rubbing dishes during washing? Disposable aluminum items can break down in the dishwasher and cause marking. Hand wash these items. Remove aluminum markings by using a mild abrasive cleaner.

■ Orange stains on plastic dishes or dishwasher interior

Are large amounts of tomato-based foods on dishes placed in the dishwasher? Stains gradually fade over time. Regular use of heated drying will slow fading. Stains will not affect dishwasher performance. Regular use of a rinse cycle and an air-dry or energy-saving dry option will reduce the likelihood of staining.

Dishes do not dry completely

■ Dishes are not dry

Did you load your dishwasher to allow proper water drainage? Do not overload. Refer to the “Dishwasher Loading” section. Use a liquid rinse aid to speed drying.

Are the plastics wet? Plastics often need towel drying.

Is the rinse aid dispenser empty? Refer to the “Rinse Aid Dispenser” section.

Did you use an air-dry option? Use a heated drying option for dryer dishes.

Dishes are damaged during a cycle

■ Chipping of dishes

Did you load the dishwasher properly? Load the dishes and glasses so they are stable and do not strike together from washing action. Minimize chipping by moving the rack in and out slowly.

NOTE: Antiques, feather-edged crystal, and similar types of china and glassware might be too delicate for automatic dishwashing. Wash by hand.

Noises

■ Grinding, grating, crunching or buzzing sounds

A hard object has entered the wash module (on some models). When the object is ground up, the sound should stop. If the noise persists after a complete cycle, call for service.

Dishwasher exterior is dirty or marked

■ Marks, smudges or residue on dishwasher exterior

Did you clean the dishwasher with a mild detergent and cloth or use a stainless steel cleaner on models with a stainless steel exterior? In most cases, regular use of a soft, damp cloth or sponge and a mild detergent is all that is necessary to keep the outside of your dishwasher looking fresh and clean. If your dishwasher has a stainless steel exterior, a stainless steel cleaner is recommended.

Get it fixed, at your home or ours!

Your Home

For repair – **in your home** – of **all** major brand appliances, lawn and garden equipment, or heating and cooling systems, **no matter who made it, no matter who sold it!**

For the replacement parts, accessories and owner's manuals that you need to do-it-yourself.

For Sears professional installation of home appliances and items like garage door openers and water heaters.

1-800-4-MY-HOME® (1-800-469-4663)

Call anytime, day or night (U.S.A. and Canada)

www.sears.com www.sears.ca

Our Home

For repair of carry-in items like vacuums, lawn equipment, and electronics, call or go on-line for the location of your nearest **Sears Parts & Repair Center.**

1-800-488-1222

Call anytime, day or night (U.S.A. only)

www.sears.com

To purchase a protection agreement (U.S.A.) or maintenance agreement (Canada) on a product serviced by Sears:

1-800-827-6655 (U.S.A.)

1-800-361-6665 (Canada)

Para pedir servicio de reparación a domicilio, y para ordenar piezas:

1-888-SU-HOGAR®

(1-888-784-6427)

Au Canada pour service en français:

1-800-LE-FOYER^{MC}

(1-800-533-6937)

www.sears.ca



Free Manuals Download Website

<http://myh66.com>

<http://usermanuals.us>

<http://www.somanuals.com>

<http://www.4manuals.cc>

<http://www.manual-lib.com>

<http://www.404manual.com>

<http://www.luxmanual.com>

<http://aubethermostatmanual.com>

Golf course search by state

<http://golfingnear.com>

Email search by domain

<http://emailbydomain.com>

Auto manuals search

<http://auto.somanuals.com>

TV manuals search

<http://tv.somanuals.com>