



# HP Officejet Pro K5300/K5400



Start  
Démarrage  
Inicio  
Início

Lea esto primero

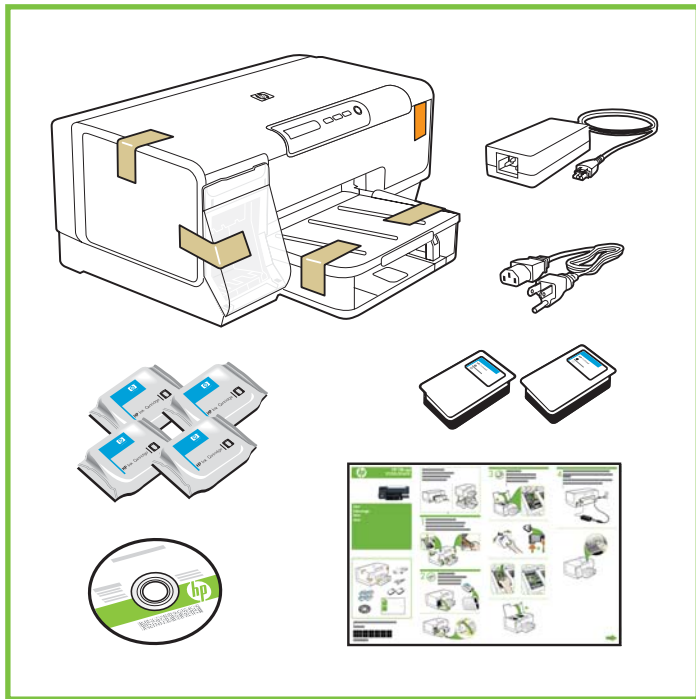

© 2007 Hewlett-Packard Development Company, L.P.

www.hp.com

Printed on at least 50% total recycled fiber with at least 10% post-consumer paper

Imprimé sur un papier composé d'au moins 50 % de fibres recyclées et 10 % de papier post-consommation

Printed in the US  
Imprimé aux Etats-Unis  
Impreso en EE.UU.  
Impresso nos E.U.A.



EN FR ES PT

Q8184-90003

Install optional accessories.  
Installation des accessoires optionnels.  
Instale los accesorios opcionales.  
Instale os acessórios opcionais.

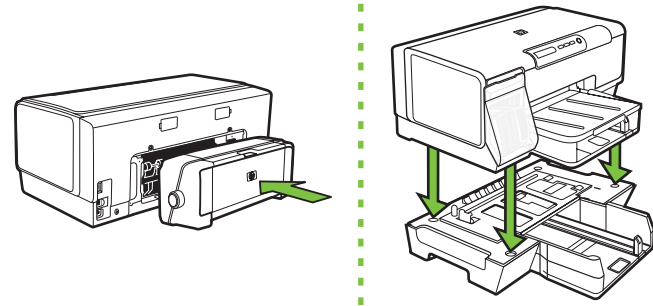

**1** Remove tape and packing materials.  
Enlevez les matériaux de bande et d'emballage.  
Retire la cinta y los materiales de embalaje.  
Remova as fitas e o material de embalagem.

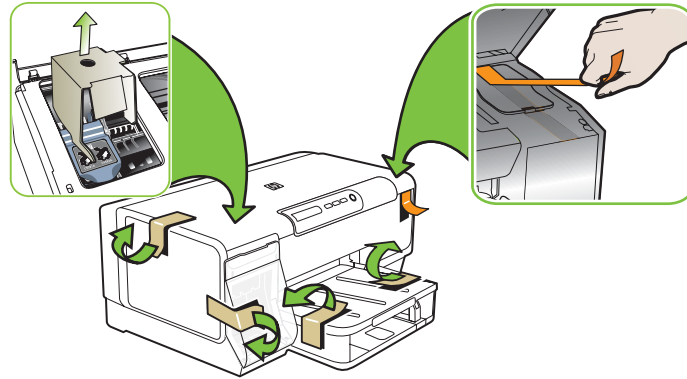

**2** Install ink cartridges.  
Installez les cartouches d'encre.  
Instale los cartuchos de tinta.  
Instale os cartuchos de tinta.

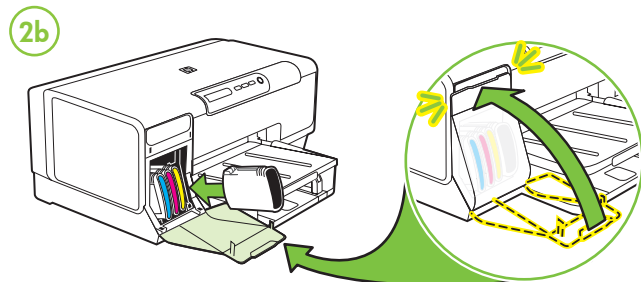
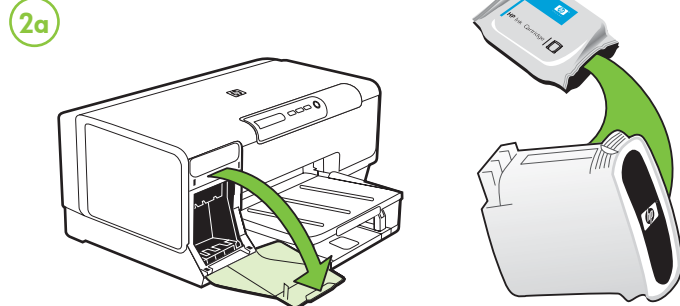

**3** Install printheads.  
Installez les cartouches d'impression.  
Instale los cabezales de impresión.  
Instale os cabeçotes de impressão.

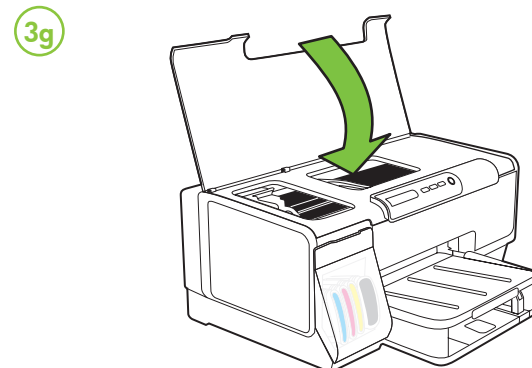
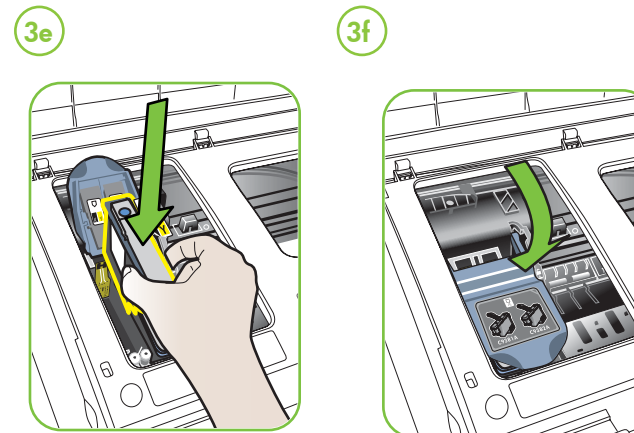
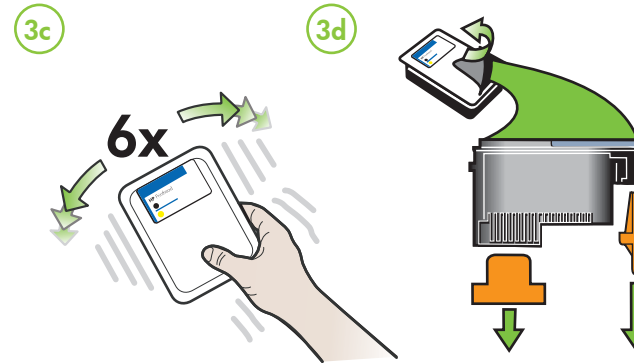
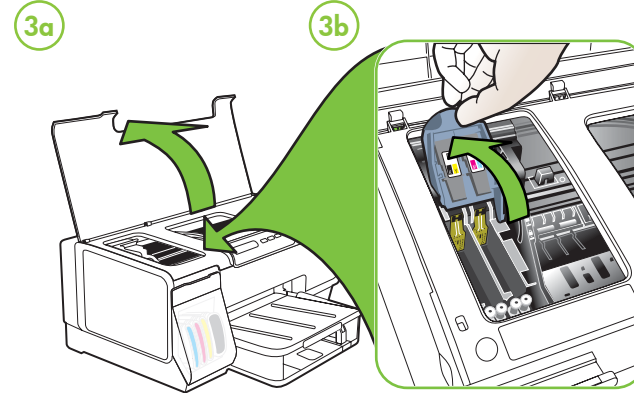

**4** Connect power cord and adapter, and turn on the device.  
Reliez le cordon d'alimentation et l'adaptateur de secteur, mettez en marche le tout-en-un.  
Conecte el cable de alimentación y el adaptador y encienda el dispositivo.  
Conecte o cabo de alimentação e o adaptador e ligue o dispositivo.

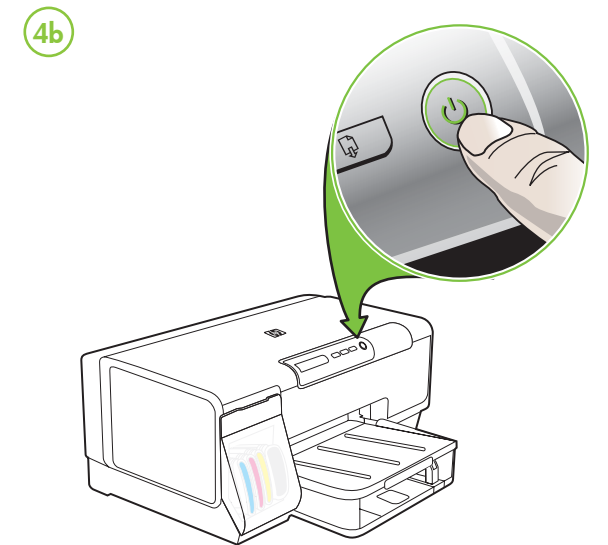
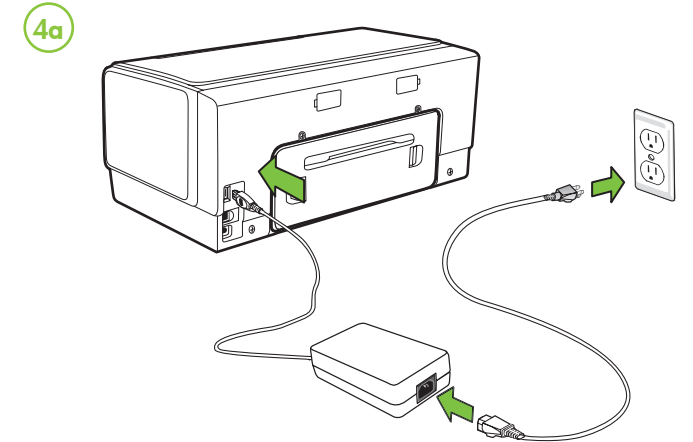

**5** Load paper when prompted and wait for auto-alignment pages to print.

Chargez le papier lorsqu'un message vous y invite et attendez l'impression des pages d'alignement automatique.

Cargue el papel cuando se le solicite y espere a que se impriman las páginas de auto alineación.

Quando solicitado, carregue papel e aguarde a impressão das páginas de alinhamento automático.

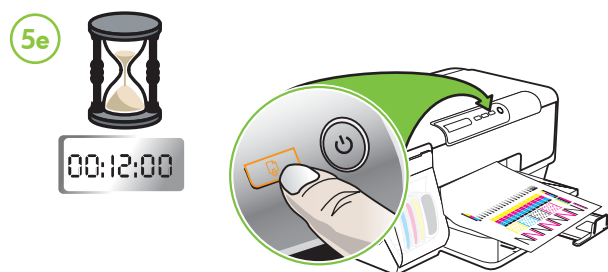
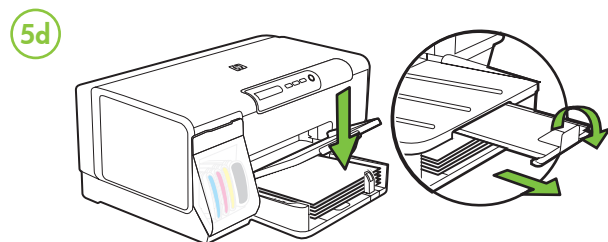
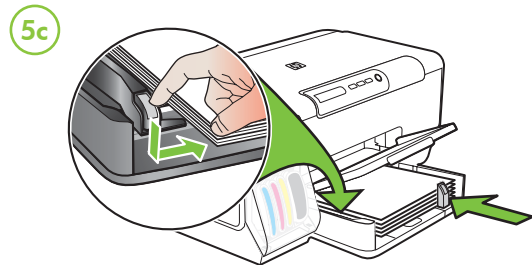
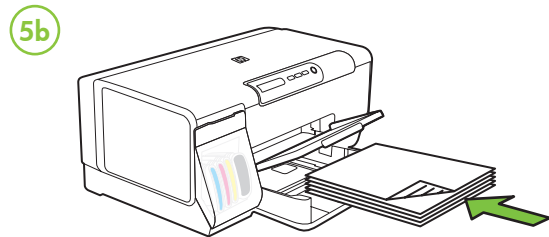
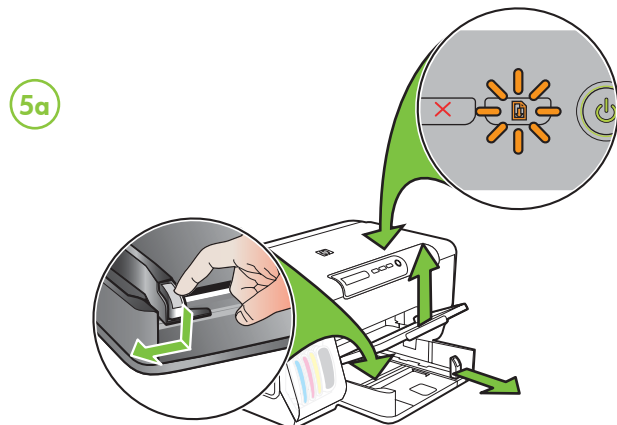

**6** Install software and connect the device.

Installez le logiciel et reliez le tout-en-un.

Instale el software y conecte el dispositivo.

Instale o software e conecte o dispositivo.

**USB**

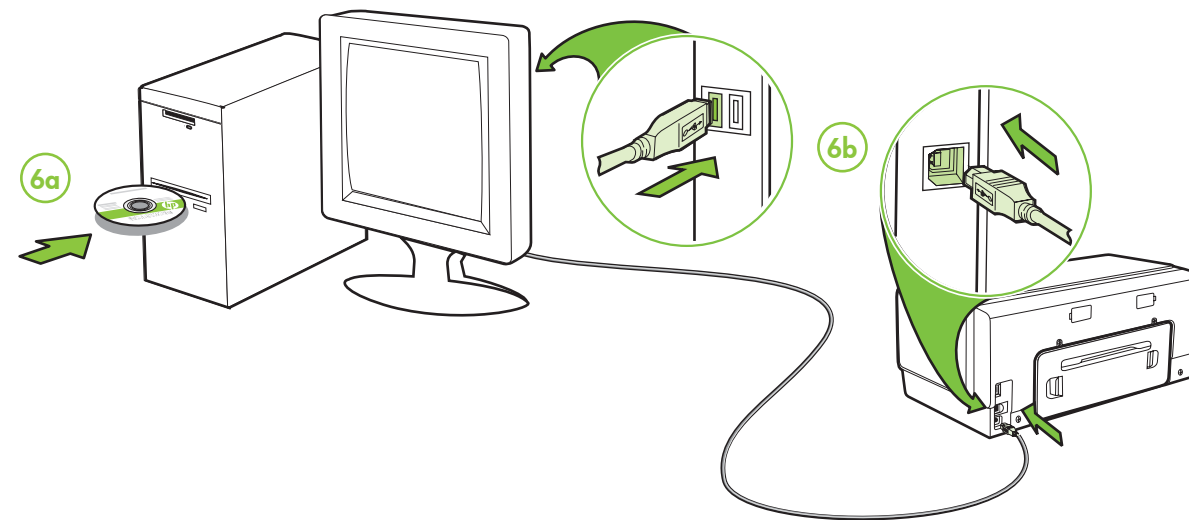

**Ethernet**

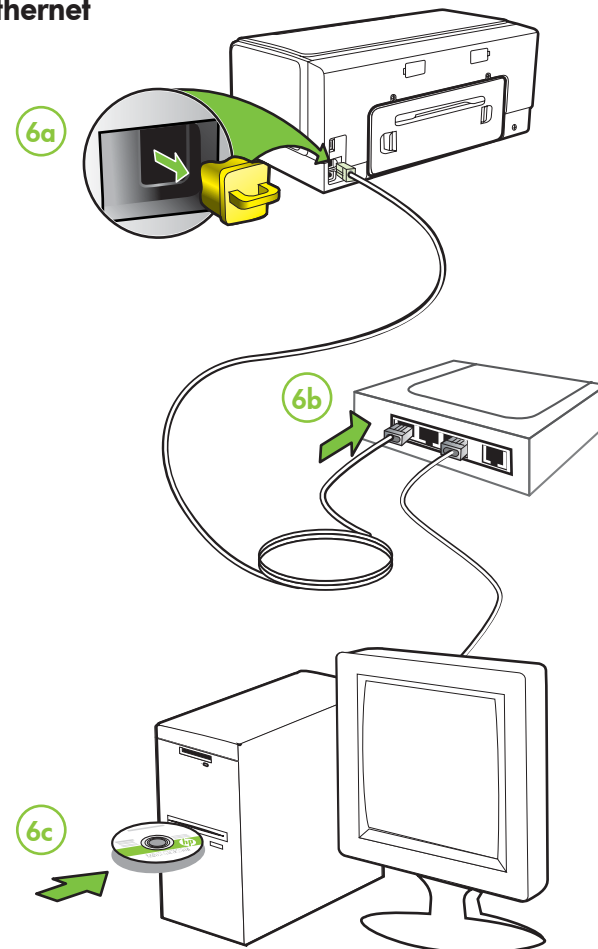

**EN** Obtain IP address or hardware (MAC) address

The configuration page contains network settings and other information for the printer. To print this page, press  on the control panel.

**FR** Obtenez une adresse IP ou une adresse matérielle (MAC).

La page de configuration contient des paramètres réseau et d'autres informations pour l'imprimante. Pour imprimer cette page, appuyez sur  sur le panneau de commande.

**ES** Obtener la dirección IP o la dirección (MAC) del hardware

La página de configuración contiene los parámetros de red y otra información de la impresora. Para imprimir esta página, presione  en el panel de control.

**PT** Obtenha o Endereço IP ou o Endereço de hardware (MAC)

A página de configuração contém as configurações de rede e outras informações para a impressora. Para imprimir a página, pressione  no painel de controle.



**EN** Additional information

See the electronic User Guide on the CD-ROM that came with the device or visit [www.hp.com/support](http://www.hp.com/support) for more information on the following topics:

- Troubleshooting information
- Important safety notices and regulatory information
- Detailed user instructions

**Note:** Ink from the cartridges is used in the printing process in a number of different ways, including in the initialization process, which prepares the device and cartridges for printing, and in printhead servicing, which keeps print nozzles clear and ink flowing smoothly. In addition, some residual ink is left in the cartridge after it is used. For more information see [www.hp.com/go/inkusage](http://www.hp.com/go/inkusage).

**FR** Informations supplémentaires

Pour plus d'informations sur les rubriques ci-après, reportez-vous à la version électronique du Guide de l'utilisateur sur le CD-ROM fourni avec l'imprimante :

- Informations de dépannage
- Informations importantes sur la sécurité et informations réglementaires
- Instructions détaillées à l'intention de l'utilisateur

**Remarque :** L'encre des cartouches est utilisée dans le processus d'impression de différentes manières, notamment dans le processus d'initialisation, qui prépare l'appareil et les cartouches pour l'impression, et dans l'entretien de la tête d'impression qui maintient les buses dégagées et garantit une libre circulation de l'encre. En outre, il reste de l'encre dans la cartouche après son utilisation. Pour plus d'informations, reportez-vous à la page Web [www.hp.com/go/inkusage](http://www.hp.com/go/inkusage).

**ES** Información adicional

Consulte la Guía del usuario electrónica en el CD-ROM que viene con el dispositivo o visite [www.hp.com/support](http://www.hp.com/support) para obtener más información acerca de los siguientes temas:

- Información sobre solución de problemas
- Avisos de seguridad importantes e información regulatoria
- Instrucciones detalladas para el usuario

**Nota:** La tinta de los cartuchos se usa en el proceso de impresión de diversas formas, que incluyen el proceso de inicialización, donde se prepara el dispositivo y los cartuchos para la impresión y el servicio de los cabezales de impresión, que mantiene los inyectores de tinta despejados y permite que la tinta fluya sin problemas. Además, se deja un poco de tinta residual en el cartucho después de su uso. Para obtener más información, consulte la página Web [www.hp.com/go/inkusage](http://www.hp.com/go/inkusage).

**PT** Informações adicionais

Consulte o Guia eletrônico do usuário no CD-ROM que acompanha o dispositivo ou visite o endereço [www.hp.com/support](http://www.hp.com/support) para obter mais informações sobre os tópicos a seguir:

- Informações sobre resolução de problemas
- Avisos importantes sobre segurança e informações regulamentares
- Instruções detalhadas para o usuário

**Nota:** A tinta dos cartuchos é usada no processo de impressão de várias maneiras, incluindo o processo de inicialização que prepara o dispositivo e os cartuchos para impressão, e o serviço de manutenção do cabeçote de impressão, que mantém os bicos de impressão limpos e a tinta fluindo normalmente. Além disso, sempre fica um pouco de tinta no cartucho após seu uso. Para obter mais informações, consulte [www.hp.com/go/inkusage](http://www.hp.com/go/inkusage).



invent

## Free Manuals Download Website

<http://myh66.com>

<http://usermanuals.us>

<http://www.somanuals.com>

<http://www.4manuals.cc>

<http://www.manual-lib.com>

<http://www.404manual.com>

<http://www.luxmanual.com>

<http://aubethermostatmanual.com>

Golf course search by state

<http://golfingnear.com>

Email search by domain

<http://emailbydomain.com>

Auto manuals search

<http://auto.somanuals.com>

TV manuals search

<http://tv.somanuals.com>