



# HP ElitePad 1000 G2 Healthcare Tablet

User Guide

© Copyright 2015 HP Development Company, L.P.

Java is a registered trademark of Oracle and/or its affiliates. microSD is a trademark or registered trademark of SD-3C in the United States, other countries or both. Windows is either a registered trademark or trademark of Microsoft Corporation in the United States and/or other countries.

The information contained herein is subject to change without notice. The only warranties for HP products and services are set forth in the express warranty statements accompanying such products and services. Nothing herein should be construed as constituting an additional warranty. HP shall not be liable for technical or editorial errors or omissions contained herein.

Third Edition: August 2015

First Edition: January 2015

Document Part Number: 798568-003

### Product notice

This user guide describes features that are common to most models. Some features may not be available on your tablet.

Not all features are available in all editions of Windows. This tablet may require upgraded and/or separately purchased hardware, drivers and/or software to take full advantage of Windows functionality. Go to <http://www.microsoft.com> for details.

To obtain the latest user guide, go to <http://www.hp.com/support>, and select your country. Select **Drivers & Downloads**, and then follow the on-screen instructions.

### Software terms

By installing, copying, downloading, or otherwise using any software product preinstalled on this tablet, you agree to be bound by the terms of the HP End User License Agreement (EULA). If you do not accept these license terms, your sole remedy is to return the entire unused product (hardware and software) within 14 days for a refund subject to the refund policy of your seller.

For any further information or to request a full refund of the price of the tablet, please contact your seller.

## Safety warning notice

---

 **WARNING!** To reduce the possibility of heat-related injuries or of overheating, do not allow the AC adapter to contact the skin or a soft surface, such as pillows or rugs or clothing, during operation. The tablet and the AC adapter comply with the user-accessible surface temperature limits defined by the International Standard for Safety of Information Technology Equipment (IEC 60950).

---



---

# Table of contents

<b>1 Welcome .....</b>	<b>1</b>
Finding information .....	2
<b>2 Getting to know your tablet .....</b>	<b>4</b>
Front .....	4
Back .....	6
Top .....	7
Bottom .....	8
Labels .....	8
Attaching the hand strap .....	10
Changing your tablet's settings .....	10
Changing your tablet's view .....	10
Using the tablet's autorotate lock feature .....	11
Adjusting your tablet's screen brightness .....	11
Finding your hardware and software information .....	11
Locating hardware .....	11
Locating software .....	11
Updating the software installed on the tablet .....	11
<b>3 Connecting to a network .....</b>	<b>12</b>
Connecting to a wireless network .....	12
Using the wireless controls .....	12
Using a WLAN .....	12
Using an Internet service provider .....	13
Setting up a WLAN .....	13
Configuring a wireless router .....	13
Protecting your WLAN .....	13
Connecting to a WLAN .....	14
Using Bluetooth wireless devices .....	15
Using HP Mobile Broadband (select models only) .....	15
Inserting and removing a micro SIM or microSD card .....	16
<b>4 Navigating using touch gestures .....</b>	<b>21</b>
Using touch screen gestures .....	21
One-finger slide .....	21
Tapping .....	22

Scrolling .....	22
2-finger pinch zoom .....	23
2-finger click .....	23
Rotating (select models only) .....	24
Edge swipes .....	24
Right-edge swipe .....	24
Left-edge swipe .....	25
Top-edge swipe .....	25
Using the on-screen keyboard .....	26

## **5 Detailed functions ..... 27**

Audio .....	27
Connecting speakers .....	27
Adjusting the volume .....	28
Connecting headphones and microphones .....	28
Checking audio functions on the tablet .....	28
Webcam .....	29
Video .....	29
HDMI .....	30
Configuring audio for HDMI .....	30
Bar-code scanner (select models only) .....	31
Configuring carriage returns .....	31
Configuring the bar-code scanner volume .....	32
Restoring default settings .....	33
Near Field Communications (NFC) .....	34

## **6 Power management ..... 35**

Shutting down the tablet .....	35
Setting power options .....	35
Using power-saving states .....	35
Initiating and exiting Sleep .....	35
Using the power meter and power settings .....	36
Setting password protection on wakeup .....	36
Using battery power .....	36
Factory-sealed battery .....	36
Finding additional battery information .....	37
Using Battery Check .....	37
Displaying the remaining battery charge .....	37
Maximizing battery discharge time .....	37
Managing low battery levels .....	37
Identifying low battery levels .....	38

Resolving a low battery level .....	38
Conserving battery power .....	39
Using external AC power .....	39
<b>7 External cards and devices .....</b>	<b>40</b>
Using smart cards .....	40
Inserting a smart card .....	40
Removing a smart card .....	41
Using a USB device .....	41
Connecting a USB device .....	41
Removing a USB device .....	41
Connecting a stylus .....	43
Using optional external devices .....	44
Using optional external drives .....	44
Installing an optional security cable .....	45
<b>8 Security .....</b>	<b>46</b>
Protecting the tablet .....	46
Using passwords .....	46
Setting passwords in Windows .....	47
Setting passwords in Computer Setup .....	47
Using antivirus software .....	47
Using firewall software .....	47
Installing critical security updates .....	48
Using HP Client Security .....	48
<b>9 Maintenance .....</b>	<b>49</b>
IP-54 rating .....	49
Cleaning your tablet .....	50
Cleaning procedures .....	50
Cleaning the display .....	51
Cleaning the tablet .....	51
Updating programs and drivers .....	51
Using SoftPaq Download Manager .....	51
<b>10 Backup and recovery .....</b>	<b>52</b>
Backing up your information .....	52
Performing a system recovery .....	52
Using the Windows recovery tools .....	52
Using f11 recovery tools .....	53

Changing the boot device order .....	53
Using Windows Refresh or Windows Reset .....	54
<b>11 Computer Setup and HP PC Hardware Diagnostics (UEFI) .....</b>	<b>55</b>
Using Computer Setup .....	55
Starting Computer Setup .....	55
Navigating and selecting in Computer Setup .....	55
Restoring factory settings in Computer Setup .....	55
Updating the BIOS .....	56
Determining the BIOS version .....	56
Downloading a BIOS update .....	57
Using HP PC Hardware Diagnostics (UEFI) .....	57
<b>12 Specifications .....</b>	<b>59</b>
Input power .....	59
Operating environment .....	59
EN 60601-1-2: 2007 .....	59
Accessories and cables .....	60
Electromagnetic emissions .....	61
Radiofrequency bandwidths .....	64
Radiofrequency transmitter bands and ERP .....	64
Emissions requirements of cables, transducers, and accessories .....	64
IEC 60601-1-2: 2014 .....	65
Accessories and cables .....	65
Electromagnetic and radiofrequency emissions .....	66
Radiofrequency bandwidths .....	68
Radiofrequency transmitter bands and ERP .....	69
<b>Appendix A Traveling with the tablet .....</b>	<b>70</b>
<b>Appendix B Troubleshooting .....</b>	<b>71</b>
Troubleshooting resources .....	71
Resolving issues .....	71
The tablet is unable to start up .....	71
An external device is not working .....	71
A video is not visible on an external display .....	72
<b>Index .....</b>	<b>73</b>



---

# 1 Welcome

After you set up and register the tablet, it is important to take the following steps:

- **Connect to the Internet**—Set up your wireless network so that you can connect to the Internet. For more information, see [Connecting to a network on page 12](#).
- **Update your antivirus software**—Protect your tablet from damage caused by viruses. The software is preinstalled on the tablet. For more information, see [Using antivirus software on page 47](#).
- **Get to know your tablet**—Learn about your tablet features. Refer to [Getting to know your tablet on page 4](#) and [Navigating using touch gestures on page 21](#) for additional information.
- **Find installed software**—Access a list of the software preinstalled on the tablet:  

On the Start screen, swipe up from the center of the touch screen to display the Apps screen. For details about using the software included with the tablet, see the software manufacturer's instructions, which may be provided with the software or on the manufacturer's website.
- Back up your hard drive by creating a recovery flash drive. See [Backup and recovery on page 52](#).

# Finding information

The tablet comes with several resources to help you perform various tasks.

Resources	For information about
<i>Setup Instructions</i> poster	<ul style="list-style-type: none"><li>• How to set up the tablet</li><li>• Help to identify tablet components</li></ul>
HP Support Assistant To access HP Support Assistant on the Start screen, tap the <b>HP Support Assistant</b> app. To obtain the latest user guide, go to <a href="http://www.hp.com/support">http://www.hp.com/support</a> , and select your country. Select <b>Drivers &amp; Downloads</b> , and then follow the on-screen instructions	<ul style="list-style-type: none"><li>• Operating system information</li><li>• Software, driver, and BIOS updates</li><li>• Troubleshooting tools</li><li>• How to access support</li></ul>
<i>Regulatory, Safety, and Environmental Notices</i> To access this guide: <ol style="list-style-type: none"><li>1. From the Start screen, type support, and then select the <b>HP Support Assistant</b> app.</li><li>2. Select <b>My computer</b>, and then tap <b>User guides</b>.</li></ol>	<ul style="list-style-type: none"><li>• Regulatory and safety information</li><li>• Environmental information</li></ul>
<i>Safety &amp; Comfort Guide</i> To access the user guides, tap the <b>HP Support Assistant</b> app on the Start screen, tap <b>My computer</b> , and then tap <b>User guides</b> . – or – Go to <a href="http://www.hp.com/ergo">http://www.hp.com/ergo</a> .	<ul style="list-style-type: none"><li>• Proper workstation setup, posture, health, and work habits</li><li>• Electrical and mechanical safety information</li></ul>
<i>Worldwide Telephone Numbers</i> booklet This booklet is provided with your tablet.	HP support telephone numbers
HP website To obtain the latest user guide, go to <a href="http://www.hp.com/support">http://www.hp.com/support</a> , and select your country. Select <b>Drivers &amp; Downloads</b> , and then follow the on-screen instructions	<ul style="list-style-type: none"><li>• Support information</li><li>• Ordering parts and finding additional help</li><li>• Accessories available for the device</li></ul>
<i>Limited Warranty*</i> To access this guide, tap the <b>HP Support Assistant</b> app on the Start screen, tap <b>My computer</b> , and then tap <b>Warranty and services</b> . – or – Go to <a href="http://www.hp.com/go/orderdocuments">http://www.hp.com/go/orderdocuments</a> .	Warranty information

\*You can find the expressly provided HP Limited Warranty applicable to your product located with the user guides on your tablet and/or on the CD/DVD provided in the box. In some countries/regions, HP may provide a printed HP Limited Warranty in the box. For some countries/regions where the warranty is not provided in printed format, you may request a printed copy from <http://www.hp.com/go/orderdocuments> or write to:

- **North America:** Hewlett-Packard, MS POD, 11311 Chinden Blvd., Boise, ID 83714, USA
- **Europe, Middle East, Africa:** Hewlett-Packard, POD, Via G. Di Vittorio, 9, 20063, Cernusco s/Naviglio (MI), Italy
- **Asia Pacific:** Hewlett-Packard, POD, P.O. Box 200, Alexandra Post Office, Singapore 911507

---

**Resources****For information about**

---

When you request a printed copy of your warranty, please include your product number, warranty period (found on your service label), name, and postal address.

**IMPORTANT:** Do NOT return your HP product to the addresses above. For worldwide support, go to <http://h20565.www2.hp.com/portal/site/hpsc>.

---

## 2 Getting to know your tablet

The following sections provide an overview of the HP ElitePad 1000 G2 Healthcare Tablet capabilities.

- [Front](#)
- [Back](#)
- [Top](#)
- [Bottom](#)
- [Labels](#)
- [Attaching the hand strap](#)
- [Changing your tablet's settings](#)
- [Finding your hardware and software information](#)

### Front

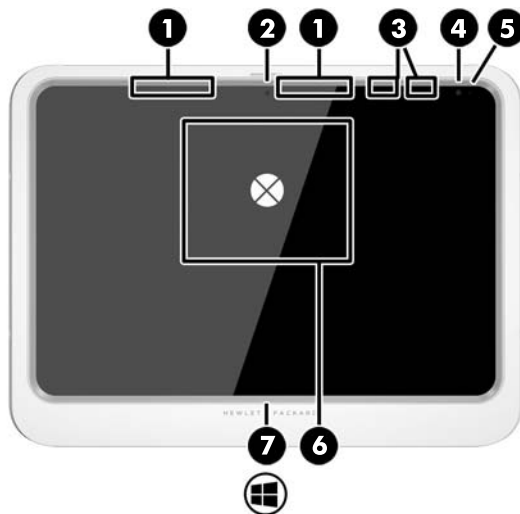

Component	Description
(1) WWAN antennas (2)* (select models only)	Send and receive wireless signals to communicate with wireless wide area networks (WWAN).
(2) Front webcam	Records video and captures still photographs.  To use the webcam, tap the <b>YouCam</b> tile on the Start screen, or swipe from the right edge of the touch screen to display the charms, tap <b>Search</b> , and then tap the search box. In the search box, type <b>c</b> , and then tap <b>CyberLink YouCam</b> .
(3) WLAN antennas (2)*	Send and receive wireless signals to communicate with wireless local area networks (WLAN).
(4) Ambient light sensor	The ambient light sensor automatically adjusts the display brightness based on the lighting conditions in your environment.

Component	Description
(5) Webcam status light (front)	On: The webcam is on.
(6) Near Field Communications (NFC) tapping area (select models only)	Allows you to touch an NFC-compatible device to this area to wirelessly connect and communicate with the tablet and transfer data back and forth.
(7) Windows button	Displays the Start screen.

\*The antennas are not visible on the outside of the tablet. For optimal transmission, keep the areas immediately around the antennas free from obstructions. To see wireless regulatory notices, see the section of the *Regulatory, Safety, and Environmental Notices* that applies to your country or region. To access the user guides, tap the **HP Support Assistant** app on the Start screen, tap **My computer**, and then tap **User guides**.

## Back



Component	Description
(1)	Hand strap connectors (4)
(2)	Smart card reader
(3)	Bar-code scanner buttons (select models only)
(4)	Webcam light
(5)	Webcam
(6)	Volume buttons (2)
(7)	Security cable slot

Attach the hand strap on the right or left side.

Supports optional smart cards.

Press to use the bar-code scanner.

For information about using the bar-code scanner, see [Bar-code scanner \(select models only\) on page 31](#).

On: The webcam is in use.

Records video and captures photographs. You can video conference and chat online using streaming video.



For information on using the webcam, access HP Support Assistant. To access HP Support Assistant, from the Start screen, select the **HP Support Assistant** app.

Control the volume.

Attaches an optional security cable to the tablet.

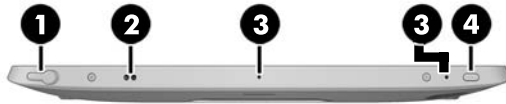
**NOTE:** The security cable is designed to act as a deterrent, but it may not prevent the tablet from being mishandled or stolen.



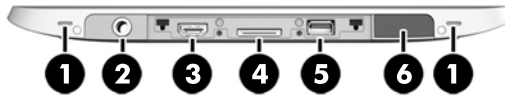

Component	Description
(1)  Audio-out (headphone)/Audio-in (microphone) jack	<p>Connects optional powered stereo speakers, headphones, earbuds, a headset, or a display audio cable. Also connects an optional headset microphone. This jack does not support optional microphone-only devices.</p> <p><b>WARNING!</b> To reduce the risk of personal injury, adjust the volume before putting on headphones, earbuds, or a headset. For additional safety information, see the <i>Regulatory, Safety, and Environmental Notices</i>. To access this guide, from the Start screen, type <code>support</code>, and then select the <b>HP Support Assistant</b> app.</p> <p><b>NOTE:</b> When a device is connected to the jack, the tablet speakers are disabled.</p> <p><b>NOTE:</b> Be sure that the device cable has a 4-conductor connector that supports both audio-out (headphone) and audio-in (microphone).</p>
(2) Stylus connector	Attaches a stylus using a lanyard.
(3) Internal microphones (2)	Record sound.
(4)  Power button	<ul style="list-style-type: none"> <li>• When the tablet is off, press the button to turn on the tablet.</li> <li>• When the tablet is on, press the button briefly to initiate Sleep.</li> <li>• When the tablet is in the Sleep state, press the button briefly to exit Sleep.</li> <li>• When the tablet is in Hibernation, press the button briefly to exit Hibernation.</li> </ul> <p><b>CAUTION:</b> Pressing and holding down the power button results in the loss of unsaved information.</p> <p>If the tablet has stopped responding and Windows® shutdown procedures are ineffective, press and hold the power button for at least 5 seconds to turn off the tablet.</p> <p>To learn more about your power settings, see your power options. From the Start screen, type <code>power</code>, select <b>Power and sleep settings</b>, and then select <b>Power and sleep</b> from the list of applications.</p>

## Bottom



 **NOTE:** To access the bottom components, lift the I/O door using both thumbs. To close the I/O door, push it in and then press down until it is firmly seated.

Component	Description
(1)	Speakers (2) Produce sound.
(2)	Shoulder strap connector Connects an optional shoulder strap.
(3) 	HDMI port Connects an optional video or audio device, such as a high-definition display, any compatible digital or audio component, or a high-speed HDMI device.
(4) 	Power connector/Docking connector Connects an AC adapter or an optional docking device.
(5) 	USB 3.0 port Connects an optional USB device, such as a keyboard, mouse, external drive, printer, scanner or USB hub. For details about different types of USB ports, see <a href="#">Using a USB device on page 41</a> .
(6)	Bar-code scanner (select models only) Scans bar codes. For information about using the bar-code scanner, see <a href="#">Bar-code scanner (select models only) on page 31</a> .

## Labels

The labels affixed to the tablet provide information you may need when you troubleshoot system problems or travel internationally with the tablet.

 **IMPORTANT:** Check the following location for the labels described in this section: on the back of the tablet.

- Service label—Provides important information to identify your tablet. When contacting support, you will probably be asked for the serial number, and possibly for the product number or the model number. Locate these numbers before you contact support.
- Microsoft® Certificate of Authenticity label (select models only prior to Windows 8)—Contains the Windows Product Key. You may need the Product Key to update or troubleshoot the operating system. HP platforms with Windows 8 or Windows 8.x preinstalled do not have the physical label. Instead a Digital Product Key is electronically installed.

 **NOTE:** The Digital Product Key is automatically recognized and activated by Microsoft operating systems when a Windows 8 or Windows 8.x operating system is reinstalled using HP-approved recovery methods.

- Regulatory label(s)—Provide(s) regulatory information about the tablet.
- Wireless certification label(s)—Provide(s) information about optional wireless devices and the approval markings for the countries or regions in which the devices have been approved for use.



- Laser label(s) (select models only)—Provide information about using the bar-code scanner laser properly.

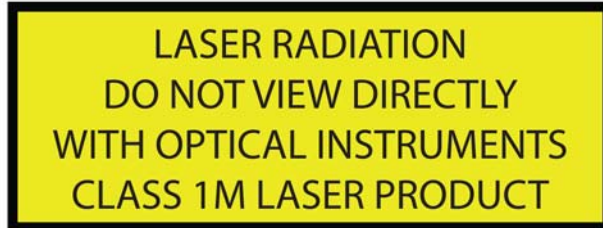

## Attaching the hand strap

Attach one of the two provided hand straps to either the left or the right side of the tablet. Retain the second hand strap and use it to replace the first hand strap when it needs to be cleaned.

To attach the hand strap:

1. Position the hand strap over either the right or left hand strap connectors on the back of the tablet.
2. Position the quick-release fasteners over the holes in the hand strap, and then connect the quick-release fasteners to secure the hand strap.

To remove the hand strap:

1. Press the center of the quick-release fastener and then lift it to remove it from the tablet. Repeat for the second quick-release fastener.



2. Remove the hand strap from the tablet.

## Changing your tablet's settings

You can change view and screen brightness.

### Changing your tablet's view

Your tablet's orientation, or view, changes automatically from landscape to portrait view, or from portrait to landscape view.

1. To change the view of your tablet from landscape view to portrait view:  
Hold the tablet vertically, and then turn it 90 degrees to the right (in a clockwise direction).
2. To change the view of your tablet from portrait view to landscape view:  
Hold the tablet vertically, and then turn it 90 degrees to the left (in a counter-clockwise direction).

## Using the tablet's autorotate lock feature

To turn on your tablet's autorotate lock feature:

1. Swipe from the right edge of the touch screen to display the charms, and then tap **Settings**.
2. Tap the screen icon to lock your current tablet screen in place and to prevent rotation. The icon displays a lock symbol when the autorotate lock is active.

To turn off your tablet's autorotate lock feature:

1. Swipe from the right edge of the touch screen to display the charms, and then tap **Settings**.
2. Tap the **Screen** icon at the bottom right, and then tap the autorotate lock icon again.

## Adjusting your tablet's screen brightness

To adjust the screen brightness:

1. Swipe from the right edge of the touch screen to display the charms, and then tap **Settings**.
2. Tap the **Screen** icon at the bottom right. A vertical slider displays that controls the screen brightness.

---

 **NOTE:** On the Windows desktop, you can also tap the **Power Meter** icon in the notification area at the far right of the taskbar, tap **Adjust screen brightness**, and then move the slider next to **Screen brightness** at the bottom of the screen.

---

# Finding your hardware and software information

## Locating hardware

To find out what hardware is installed on your tablet:

1. Swipe from the right edge of the touch screen to display the charms, tap **Search**, and then tap the search box.
2. In the search box, type `device manager`, and then tap **Device Manager**.

A list displays all the devices installed on your tablet.

## Locating software

- ▲ To find out what software is installed on your tablet, on the Start screen, swipe up from the center of the touch screen to display the Apps screen.

## Updating the software installed on the tablet

Most software, including the operating system, is updated frequently by the manufacturer or provider. Important updates to the software included with the tablet may have been released since the tablet left the factory.

Some updates may affect the way the tablet responds to optional software or external devices. Many updates provide security enhancements.

Update the operating system and other software installed on the tablet as soon as the tablet is connected to the Internet. Access the updates on the HP website at <http://www.hp.com>.

---

## 3 Connecting to a network

Your tablet can travel with you wherever you go. But even at your office, you can explore the globe and access information from millions of websites using your tablet and a wireless network connection. This chapter will help you get connected to that world.

### Connecting to a wireless network

Wireless technology transfers data across radio waves instead of wires. Your tablet may be equipped with one or more of the following wireless devices:

- **Wireless local area network (WLAN) device**—Connects the tablet to wireless local area networks (commonly referred to as Wi-Fi networks, wireless LANs, or WLANs) in corporate offices, your home, and public places such as airports, restaurants, coffee shops, hotels, and universities. In a WLAN, the mobile wireless device in your tablet communicates with a wireless router or a wireless access point.
- **Bluetooth device**—Creates a personal area network (PAN) to connect to other Bluetooth-enabled devices such as computers, phones, printers, headsets, speakers, and cameras. In a PAN, each device communicates directly with other devices, and devices must be relatively close together—typically within 10 meters (approximately 33 feet) of each other.

For more information about wireless technology, see the information and website links provided in HP Support Assistant. To access HP Support Assistant, on the Start screen, tap the **HP Support Assistant** app.

### Using the wireless controls

The Network and Sharing Center allows you to set up a connection or network, connect to a network, manage wireless networks, and diagnose and repair network problems.

To use operating system controls:

1. Swipe from the right edge of the touch screen to display the charms, tap **Settings**, and then tap **Control Panel**.
2. Select **Network and Internet**, and then tap **Network and Sharing Center**.

For more information, access HP Support Assistant. To access HP Support Assistant, on the Start screen, tap the **HP Support Assistant** app.

### Using a WLAN

With a WLAN device, you can access a wireless local area network (WLAN), which is composed of other computers and accessories that are linked by a wireless router or a wireless access point.



**NOTE:** The terms *wireless router* and *wireless access point* are often used interchangeably.

- A large-scale WLAN, such as a corporate or public WLAN, typically uses wireless access points that can accommodate a large number of computers and accessories and can separate critical network functions.
- A home or small office WLAN typically uses a wireless router, which allows several wireless and wired computers to share an Internet connection, a printer, and files without requiring additional pieces of hardware or software.

To use the WLAN device in your tablet, you must connect to a WLAN infrastructure (provided through a service provider or a public or corporate network).

## Using an Internet service provider

When you are setting up Internet access in your home, you must establish an account with an Internet service provider (ISP). To purchase Internet service and a modem, contact a local ISP. The ISP will help set up the modem, install a network cable to connect your wireless tablet to the modem, and test the Internet service.

 **NOTE:** Your ISP will give you a user ID and a password to use for Internet access. Record this information and store it in a safe place.

## Setting up a WLAN

To set up a WLAN and connect to the Internet, you need the following equipment:

- A broadband modem (either DSL or cable) **(1)** and high-speed Internet service purchased from an Internet service provider
- A wireless router **(2)** (purchased separately)
- A wireless tablet **(3)**

 **NOTE:** Some modems have a built-in wireless router. Check with your ISP to determine what type of modem you have.

The illustration below shows an example of a wireless network installation that is connected to the Internet.



As your network grows, additional wireless and wired computers can be connected to the network to access the Internet.

For help in setting up your WLAN, see the information provided by your router manufacturer or your ISP.

## Configuring a wireless router

For help in setting up a WLAN, see the information provided by your router manufacturer or your ISP.

## Protecting your WLAN

When you set up a WLAN or access an existing WLAN, always enable security features to protect your network from unauthorized access. WLANs in public areas (hotspots) like coffee shops and airports may not provide any security. If you are concerned about the security of your tablet in a hotspot, limit your network activities to email that is not confidential and basic Internet surfing.

Wireless radio signals travel outside the network, so other WLAN devices can pick up unprotected signals. Take the following precautions to protect your WLAN:

- Use a firewall.

A firewall checks both data and requests for data that are sent to your network, and discards any suspicious items. Firewalls are available in both software and hardware. Some networks use a combination of both types.

- Use wireless encryption.

Wireless encryption uses security settings to encrypt and decrypt data that is transmitted over the network. For more information, access HP Support Assistant. To access HP Support Assistant, on the Start screen, tap the **HP Support Assistant** app.

## Connecting to a WLAN

To connect to the WLAN, follow these steps:

1. Be sure that the WLAN device is on.
2. On the Start screen, swipe from the right edge of the touch screen to display the charms, tap **Settings**, and then tap the network icon.

– or –

On the Windows desktop, tap the network status icon in the notification area, at the far right of the taskbar.

3. Be sure that airplane mode is off, select a WLAN from the list, and then tap **Connect**.

If the WLAN is a security-enabled WLAN, you are prompted to enter a security code. Type the code, and then tap **Sign in**.

---

 **NOTE:** If no WLANs are listed, you may be out of range of a wireless router or access point.

 **NOTE:** If you do not see the WLAN you want to connect to, on the Start screen, swipe from the right edge of the touch screen to display the charms, tap **Search**, tap in the Search box, type `network and sharing`, and then select **Network and Sharing Center**, or on the Windows desktop, tap and hold the network status icon, and then tap **Open Network and Sharing Center**. Tap **Set up a new connection or network**. A list of options is displayed, allowing you to manually search for and connect to a network or to create a new network connection.

---

4. Follow the on-screen instructions to complete the connection.

After the connection is made, tap the network status icon in the notification area, at the far right of the taskbar, to verify the name and status of the connection.

---

 **NOTE:** The functional range (how far your wireless signals travel) depends on WLAN implementation, router manufacturer, and interference from other electronic devices or structural barriers such as walls and floors.

---

## Using Bluetooth wireless devices

A Bluetooth device provides short-range wireless communications that replace the physical cable connections that traditionally link electronic devices such as the following:

- Computers (desktop, notebook, PDA)
- Phones (cellular, cordless, smart phone)
- Imaging devices (printer, camera)
- Audio devices (headset, speakers)
- Mouse

Bluetooth devices provide peer-to-peer capability that allows you to set up a personal area network (PAN) of Bluetooth devices. For information about configuring and using Bluetooth devices, see the Bluetooth software Help.

## Using HP Mobile Broadband (select models only)

HP Mobile Broadband enables your tablet to use WWANs to access the Internet from more places and over larger areas than it can by using WLANs. Using HP Mobile Broadband requires a network service provider (called a *mobile network operator*), which in most cases is a cellular phone network operator. Coverage for HP Mobile Broadband is similar to cellular phone voice coverage.

If your tablet has HP Mobile Broadband, it is also equipped with Global Positioning System (GPS) functionality. GPS satellites deliver location, speed, and direction information to GPS-equipped systems.

When used with mobile network operator service, HP Mobile Broadband gives you the freedom to stay connected to the Internet, send email, or connect to your corporate network whether you are on the road or outside the range of Wi-Fi hotspots.

HP supports the following technologies:

- HSPA (High Speed Packet Access), which provides access to networks based on the Global System for Mobile Communications (GSM) telecommunications standard.
- EV-DO (Evolution Data Optimized), which provides access to networks based on the code division multiple access (CDMA) telecommunications standard.
- LTE (Long Term Evolution), which provides access to networks supporting LTE technology.

You may need the HP Mobile Broadband Module serial number to activate mobile broadband service.

Some mobile network operators require the use of a SIM. A SIM contains basic information about you, such as a personal identification number (PIN), as well as network information. Some tablets include a SIM that is preinstalled. If the SIM is not preinstalled, it may be provided in the HP Mobile Broadband information provided with your tablet, or the mobile network operator may provide it separately from the tablet.

For information about inserting and removing the SIM, see [Inserting and removing a micro SIM or microSD card on page 16](#) in this chapter.

For information about HP Mobile Broadband and how to activate service with a preferred mobile network operator, see the HP Mobile Broadband information included with your tablet.

## Inserting and removing a micro SIM or microSD card

**CAUTION:** To prevent damage to the connectors, use minimal force when inserting a micro SIM or microSD card.

**WARNING!** HP recommends that HP Custom Integration Services (CIS), an authorized HP service provider, or participants in the HP Self-Maintainer program perform insertion or removal of a micro SIM or microSD card. Any damage caused by the customer removing the tablet from the jacket is not covered under the limited warranty of the product. HP requires that HP Custom Integration Services (CIS), an authorized HP service provider, or participants in the HP Self-Maintainer program perform future maintenance operations.

To insert or remove a micro SIM or microSD card, follow these steps:

**NOTE:** To see a video of how to remove and replace the tablet jacket, go to <http://www.hp.com/go/sml>.

1. Shut down the tablet.
2. Disconnect all external devices connected to the tablet.
3. Unplug the power cord from the AC outlet.
4. Remove the top four screws **(1)**, and then remove the eight screws from the bottom and sides of the jacket **(2)**. Two of the bottom screws are inside the bottom I/O door.

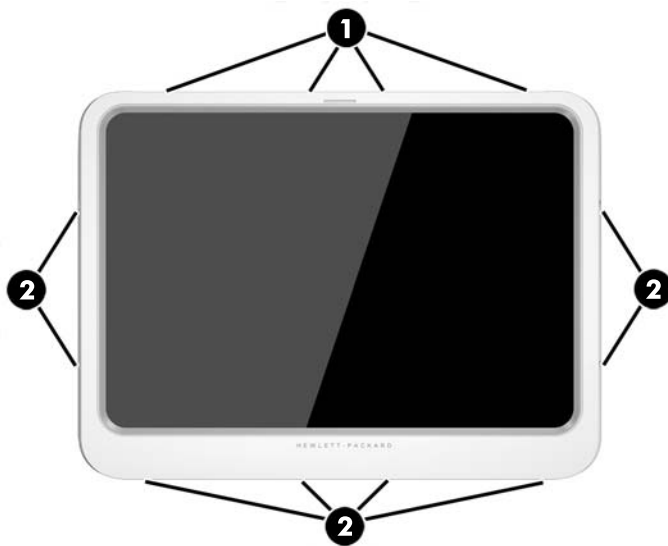



5. Carefully lift the edges of the front cover of the jacket, and then remove the cover.



6. Lift the tablet from the jacket at an angle, starting at the top.



7. Insert the end of a paper clip into the access door release hole **(1)**.
8. Press in gently until the access door is released, and then open the access door **(2)**.

9. Insert the micro SIM into the micro SIM slot **(3)** or the microSD card into the microSD card reader. Then, press in to lock it into place.

– or –

Release the micro SIM or microSD card by pressing on it. Then, remove it.

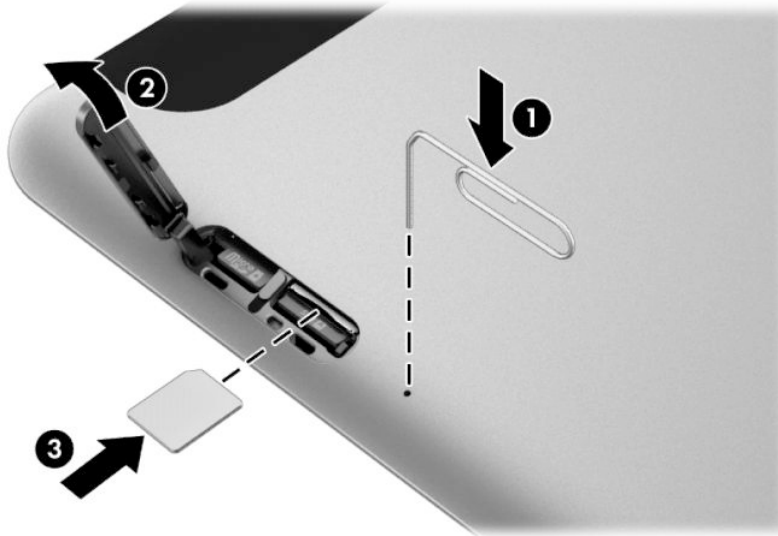

10. Reseat the access door hinge **(1)**, and then close the access door **(2)**.



11. Insert the tablet into the bottom cover of the jacket, making sure that the power connector on the bottom cover is inserted into the power connector port of the tablet. Be sure that the edges of the tablet are flush with the bottom cover.

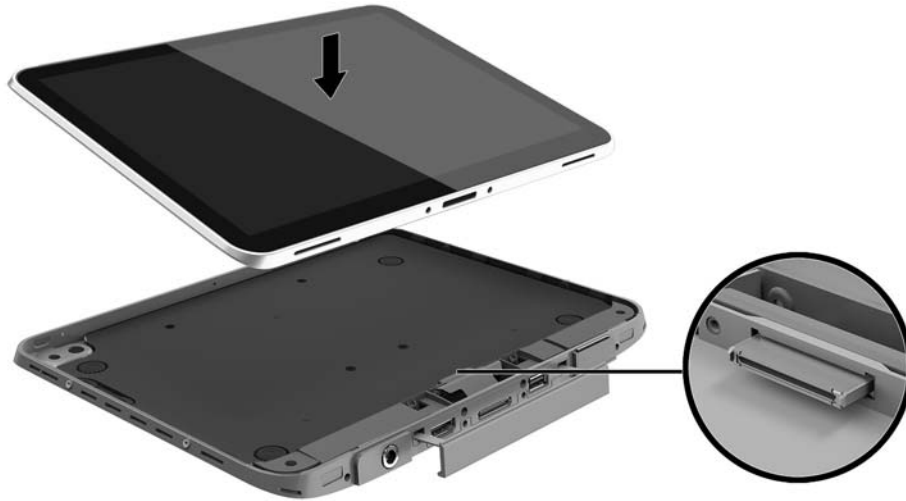

12. Starting with the top edge (1), gently press the front cover of the jacket onto the bottom cover until it snaps into place (2). Turn the tablet over and apply pressure to the bottom cover to confirm that the assembly is secure.



**NOTE:** Make sure that the power button is properly positioned in the cutout.

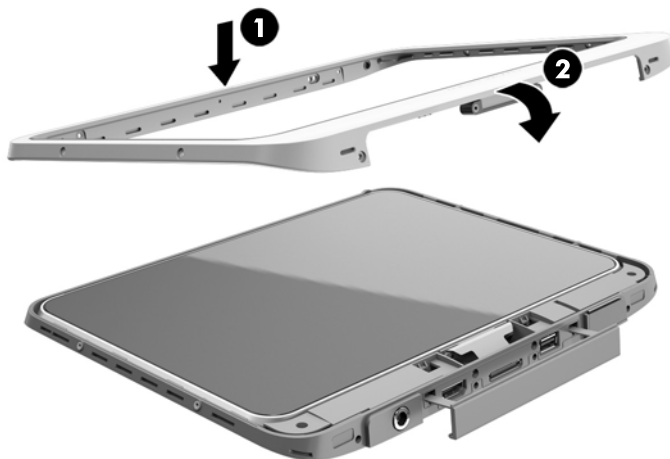

13. Insert and partially tighten the 12 screws in the order shown in the following figure. Then, firmly tighten the screws.

**CAUTION:** Overtightening the screws can degrade the tablet's resistance to water and dust.

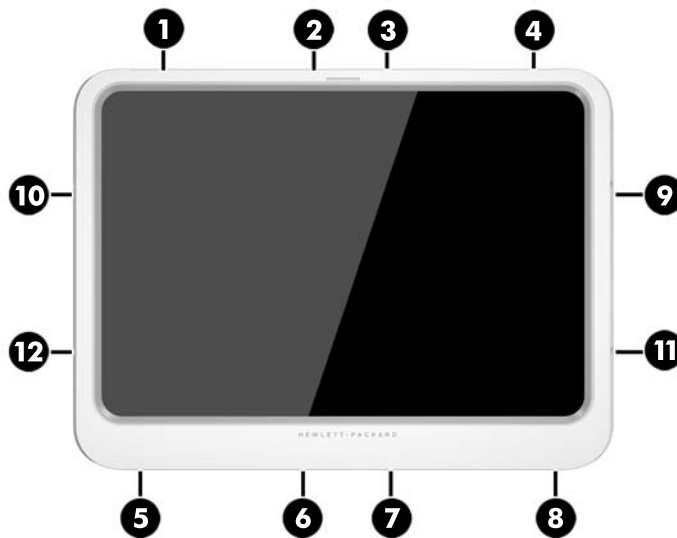

14. Reconnect external power.
15. Reconnect external devices.
16. Turn on the tablet.

---

## 4 Navigating using touch gestures

Your tablet allows navigation using touch gestures on the touch screen.

### Using touch screen gestures

You can control items on the touch screen directly with your fingers.

#### One-finger slide

The one-finger slide is mostly used to pan or scroll through lists and pages, but you can use it for other interactions, too, such as moving an object.

- To scroll across the screen, lightly slide one finger across the screen in the direction you want to move.

---

 **NOTE:** When many apps are displayed on the Start screen, you can slide your finger to move the screen left or right.

---

- To drag, press and hold an object, and then drag the object to move it.

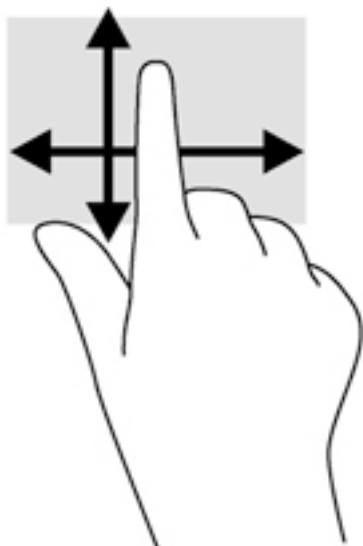

## Tapping

To make an on-screen selection, use the tap function.

- Use one finger to tap an object on the screen to make a selection. Double-tap an item to open it.

 **NOTE:** Press and hold your finger on an object to open a help screen that provides information about the object.

---



## Scrolling

Scrolling is useful for moving the pointer up, down, left, or right on a page or image.

- Place two fingers on the screen and then drag them in an up, down, left, or right motion.

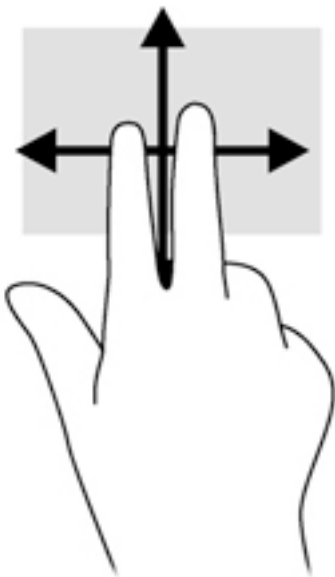

## 2-finger pinch zoom

2-finger pinch zoom allows you to zoom out or in on images or text.

- Zoom in by placing two fingers together on the display and then moving your fingers apart.
- Zoom out by placing two fingers apart on the display and then moving your fingers together.

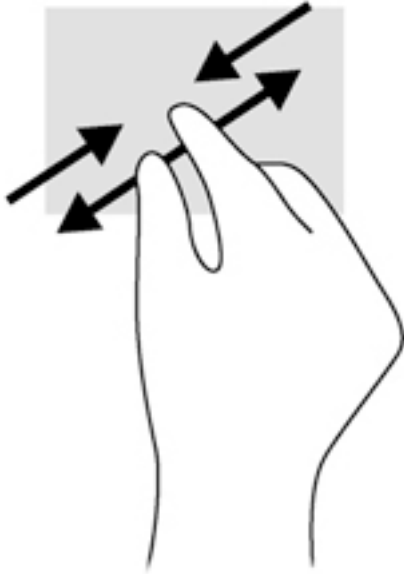

## 2-finger click

2-finger click allows you to make menu selections for an object on the screen.

 **NOTE:** Using 2-finger click is the same action as using right-click with a mouse.

- Place two fingers on the TouchPad zone and press to open the options menu for the selected object.



## Rotating (select models only)

Rotating allows you to turn items such as photos.

- Anchor the forefinger of your left hand on the object you want to rotate. Using your right hand, slide your forefinger around in a sweeping motion from 12 o'clock to 3 o'clock. To reverse the rotation, move your forefinger from 3 o'clock to 12 o'clock.



**NOTE:** Rotate is intended for specific apps where you can manipulate an object or image. Rotate may not be functional for all apps.

---

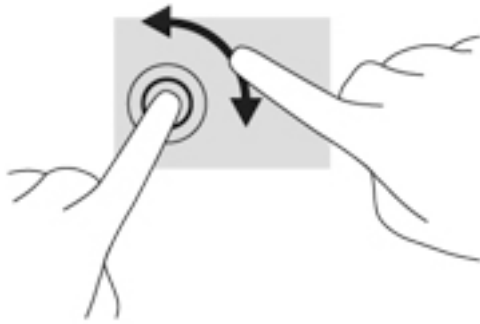

## Edge swipes

Edge swipes allow you to access toolbars on your tablet for tasks such as changing settings and finding or using apps.

### Right-edge swipe

The right-edge swipe reveals the charms, which let you search, share, start apps, access devices, or change settings.

- Swipe your finger gently from the right edge to reveal the charms.

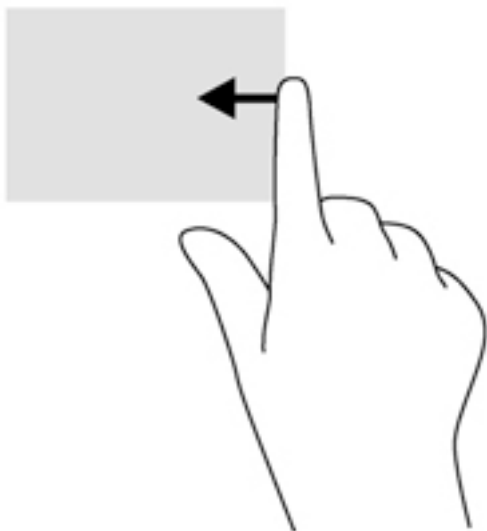



## Left-edge swipe

The left-edge swipe reveals your open apps so that you can switch between them quickly.

- Swipe your finger gently from the left edge to switch between apps. Without lifting your finger, swipe back toward the left edge to display all open apps.

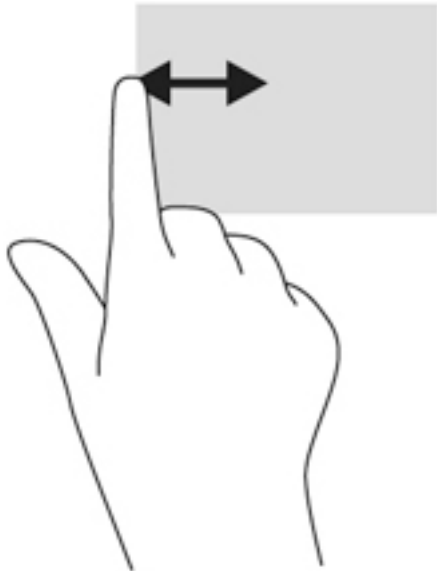

## Top-edge swipe

The top-edge swipe displays app command options that allow you to customize apps.

- Gently swipe finger from the top edge to reveal the app command options.

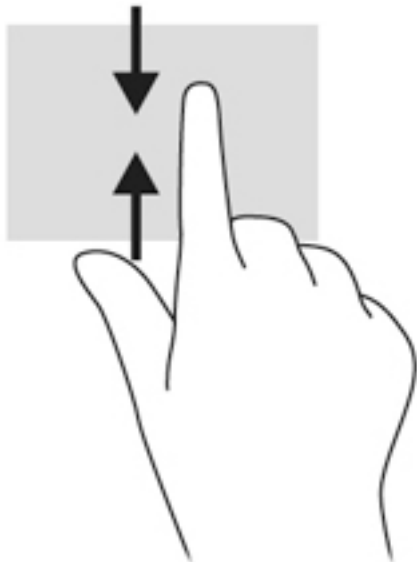

## Using the on-screen keyboard

You may want to enter data into a data field. This may be required when you set up a wireless network configuration or a weather reporting location, or when you access user accounts on Internet sites. The tablet has an on-screen keyboard that is displayed when you need to enter such information into data fields.

1. To display the keyboard on the Start screen, tap in the first data field. The keyboard is displayed.

– or –

To display the keyboard on the Windows desktop, tap the keyboard icon in the navigation area, at the far right of the taskbar.

2. Tap each character, continuing until you have spelled out the name or word that you are entering into the data field.



---

**NOTE:** Suggested words may be displayed at the top of the keyboard. If an appropriate word is displayed, tap to select it.

---

3. Tap **enter** on the keyboard.

To change settings for the on-screen keyboard:

1. Swipe from the right side of the touch screen to display the charms, and then tap **Settings**.
2. Tap **Change PC settings**, tap **PC and devices**, tap **Typing**, and then follow the on-screen instructions.

---

## 5 Detailed functions

Your tablet includes the following:

- Integrated speakers
- Integrated microphones
- Integrated webcam
- Bar-code scanner (select models only)
- Multimedia buttons or keys



**NOTE:** The I/O door on the bottom of the tablet provides access to multimedia ports. Do not use this door as a handle.

---



### Audio

Using your tablet, you can download and listen to music, stream audio content from the web (including radio), record audio, or mix audio and video to create multimedia. To enhance your listening enjoyment, attach external audio devices such as speakers or headphones.

#### Connecting speakers

You can attach wired speakers to your tablet by connecting them to a USB port or to the audio-out (headphone)/audio-in (microphone) jack on your tablet or on a docking station.

To connect wireless speakers to your tablet, follow the device manufacturer's instructions. To connect high-definition speakers to the assembly, see [Configuring audio for HDMI on page 30](#). Before connecting audio devices, be sure to adjust the volume.

## Adjusting the volume

You can adjust the volume using the volume buttons on the back of the tablet.

 **WARNING!** To reduce the risk of personal injury, adjust the volume before putting on headphones, earbuds, or a headset. For additional safety information, see the *Regulatory, Safety and Environmental Notices*. To access this guide, from the Start screen, type `support`, and then select the **HP Support Assistant** app.

 **NOTE:** Volume can also be controlled through the operating system and some programs.

## Connecting headphones and microphones

You can connect wired headphones or headsets to the audio-out (headphone)/audio-in (microphone) jack on your tablet. Many headsets with integrated microphones are commercially available.

Only vertical 6.3 mm headphone jacks are compatible with this tablet.

To connect *wireless* headphones or headsets to your tablet, follow the device manufacturer's instructions.

 **WARNING!** To reduce the risk of personal injury, lower the volume setting before putting on headphones, earbuds, or a headset. For additional safety information, see the *Regulatory, Safety and Environmental Notices*. To access this guide, from the Start screen, type `support`, and then select the **HP Support Assistant** app.

 **NOTE:** If the audio functions are not working correctly, see your tablet user guide for troubleshooting suggestions.

## Checking audio functions on the tablet

 **NOTE:** For best results when recording, speak directly into the microphone and record sound in a setting free of background noise.

To check the audio functions on your tablet, follow these steps:

1. Swipe from the right edge of the touch screen to display the charms, tap **Search**, and then tap the search box.
2. In the search box, type `c`, and then tap **Control Panel**.
3. Tap **Hardware and Sound**, and then tap **Sound**.

When the Sound window opens, tap the **Sounds** tab. Under **Program Events**, tap any sound event, such as a beep or alarm and then tap **Test**. You should hear sound through the speakers or through connected headphones.

To check the recording functions on your tablet, follow these steps:

1. Swipe from the right edge of the touch screen to display the charms, tap **Search**, and then tap the search box
2. In the search box, type `so`, and then tap **Sound Recorder**.
3. Tap **Start Recording** and speak into the microphone.
4. Save the file to your Windows desktop.
5. Open a multimedia program and play back the recording.

To confirm or change the audio settings on your tablet:

1. Swipe from the right edge of the touch screen to display the charms, tap **Search**, and then tap the search box.
2. In the search box, type **c**, and then tap **Control Panel**.
3. Tap **Hardware and Sound**, and then tap **Sound**.

## Webcam

Your tablet includes two integrated webcams. With the preinstalled software, you can use the webcams to take a photo or record a video. You can preview and save the photo or video recording.

The webcam software enables you to experiment with the following features:

- Capturing and sharing video
- Streaming video with instant message software
- Taking still photos

For best results, use both hands to steady the tablet.

For details about using the webcam, see the webcam software Help.

## Video

Your HP tablet is a powerful video device that enables you to watch streaming video from your favorite websites and download video and movies to watch on your tablet without needing to connect to a network.

To enhance your viewing enjoyment, use the video port on the tablet to connect an external monitor, projector, or TV. The high-definition multimedia interface (HDMI) port allows you to connect a high-definition monitor or TV.

---

 **IMPORTANT:** Be sure that the external device is connected to the correct port on the tablet, using the correct cable. Check the device manufacturer's instructions if you have questions.

 **NOTE:** For information about your tablet's video ports, see [Getting to know your tablet on page 4](#).

---

## HDMI

The HDMI port connects the tablet to an optional video or audio device, such as a high-definition display, or to any compatible digital or audio component.

 **NOTE:** To transmit video and/or audio signals through the HDMI port, you need an HDMI cable (purchased separately).

One HDMI device can be connected to the HDMI port on the tablet. The information displayed on the tablet screen can be simultaneously displayed on the HDMI device.

To connect a video or audio device to the HDMI port:

1. After opening the I/O door at the bottom of the tablet, connect one end of the HDMI cable to the HDMI port on the tablet.

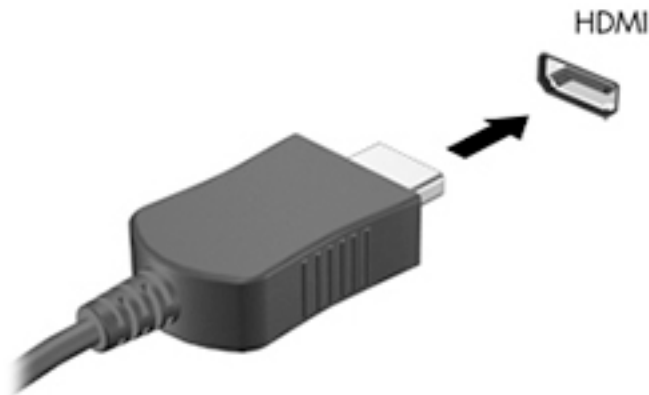

2. Connect the other end of the cable to the video device.
3. You can alternate the tablet screen image between 4 display states:
  - **PC screen only:** View the screen image on the tablet only.
  - **Duplicate:** View the screen image simultaneously on both the tablet and external device.
  - **Extend:** View the screen image extended across both the tablet and external device.
  - **Second screen only:** View the screen image on the external device only.

 **NOTE:** For best results, especially if you choose the “Extend” option, adjust the screen resolution of the external device, as follows. From the Start screen, enter `control panel`, and then select **Control Panel** from the list of applications. Select **Appearance and Personalization**. Under **Display**, select **Adjust screen resolution**.

## Configuring audio for HDMI

To configure HDMI audio, first connect an audio or video device, such as a high-definition display, to the HDMI port on your tablet. Then configure the default audio playback device as follows:

1. From the Windows desktop, right-click the **Speakers** icon in the notification area, at the far right of the taskbar, and then select **Playback devices**.
2. On the Playback tab, select either **Digital Output** or **Digital Output Device (HDMI)**.
3. Click **Set Default**, and then select **OK**.

To return audio to the tablet speakers, follow these steps:

1. From the Windows desktop, right-click the **Speakers** icon in the notification area, at the far right of the taskbar, and then select **Playback devices**.
2. On the Playback tab, select **Speakers**.
3. Click **Set Default**, and then select **OK**.

## Bar-code scanner (select models only)

To use the bar-code scanner:

1. Open a bar-code reading utility (sold separately) that you have installed on the tablet.
2. Press and hold one of the bar-code scanner buttons, and aim the scanner beam at the bar code.
3. The cross is the center of the field of view and the red dots are the border. Make sure that the scanner beam covers the entire bar code.

 **TIP:** For best results, steady the tablet using both hands, with the scanner lens 152.4 or 177.8 mm (six or seven inches) from the bar code.



 **WARNING!** Do not look at the scanner beam with a magnifying device positioned closer than 100 mm (3.9 in). Doing so can cause an eye injury.

4. A green dot appears after a successful scan.

 **NOTE:** For more information about programming the bar-code scanner, go to <http://www.datalogic.com/>.

## Configuring carriage returns

To configure the bar-code scanner to insert a carriage return after each scanned bar code:

1. Open programming mode by scanning the following QR code.



2. Scan the following QR code.



3. Exit programming mode by scanning the following QR code.

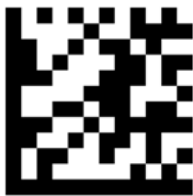

The bar-code scanner inserts a carriage return after each scanned bar code until you either repeat the previous procedure or restore the default settings (see [Restoring default settings on page 33](#)).

## Configuring the bar-code scanner volume

The tablet is shipped with the tone and volume of the bar-code scanner turned off.

To turn on the tone and adjust the volume:

1. Open programming mode by scanning the following QR code.



2. Scan one of the following QR codes:

- To set the volume to low:





- To set the volume to medium:



- To set the volume to high:



- To turn the volume off:



3. Exit programming mode by scanning the following QR code.

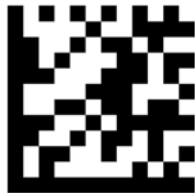

## Restoring default settings

To restore the bar-code scanner to its original settings:

1. Open programming mode by scanning the following QR code.



2. Scan the following QR code.



3. Exit programming mode by scanning the following QR code.



## Near Field Communications (NFC)

You can touch an NFC-compatible device to the center front NFC area on the tablet to wirelessly connect and communicate with the tablet and transfer data back and forth. NFC can also be used for security purposes. See [Front on page 4](#) to locate the NFC tapping area.

The tablet supports communication with Type 1 and Type 2 NFC devices within <20 mm and Type 4A NFC devices within 10 mm. See your device documentation to determine its NFC type.

---

# 6 Power management

---

 **NOTE:** Your tablet has a power button.

---

## Shutting down the tablet

---

 **CAUTION:** Unsaved information is lost when the tablet shuts down.

---

The shutdown command closes all open programs, including the operating system, and then turns off the tablet.

Shut down the tablet when the tablet will be unused and disconnected from external power for an extended period

Although you can turn off the tablet with the power button, the recommended procedure is to use the Windows shutdown command:

---

 **NOTE:** If the tablet is in the Sleep state, you must first exit Sleep before shutdown is possible by briefly pressing the power button.

---

1. Save your work and close all open programs.
2. Swipe from the right edge of the touch screen to display the charms, tap **Settings**, tap the **Power** icon, and then tap **Shut down**.

If the tablet is unresponsive and you are unable to use the preceding shutdown procedure, try the following emergency procedures in the sequence provided:

- Press and hold the power button for at least 5 seconds.
- Disconnect the tablet from external power.

## Setting power options

### Using power-saving states

Sleep is enabled at the factory.

When Sleep is initiated, the screen clears, and your work is saved to memory.

---

 **CAUTION:** To reduce the risk of possible audio and video degradation, loss of audio or video playback functionality, or loss of information, do not initiate Sleep while reading from or writing to a disc or an external media card.

---

### Initiating and exiting Sleep

With the tablet on, you can initiate Sleep in any of the following ways:

- Briefly press the power button.
- Swipe from the right edge of the touch screen to display the charms, tap **Settings**, tap the **Power** icon, and then tap **Sleep**.

To exit Sleep, briefly press the power button.

When the tablet exits Sleep, the tablet returns to the screen where you stopped working.



**NOTE:** If you have set a password to be required on wakeup, you must enter your Windows password before the tablet will return to the screen.

---

## Using the power meter and power settings

The power meter is located on the Windows desktop. The power meter allows you to quickly access power settings and view the remaining battery charge.

- To display the percentage of remaining battery charge and the current power plan, on the Windows desktop, tap the power meter icon.
- To use Power Options, or to change the power plan, tap the power meter icon, and then tap an item from the list. Swipe from the right edge of the touch screen to display the charms, tap **Search**, and then tap the search box. In the search box, type `power`, tap **Settings**, and then tap **Power Options**.

Different power meter icons indicate whether the tablet is running on battery or external power. The icon also displays a message if the battery has reached a low or critical battery level.

## Setting password protection on wakeup

To set the tablet to prompt for a password when the tablet exits Sleep, follow these steps:

1. Swipe from the right edge of the touch screen to display the charms, tap **Search**, and then tap the search box.
2. In the search box, type `power`, tap **Settings**, and then tap **Power Options**.
3. In the left pane, tap **Require a password on wakeup**.
4. Tap **Change Settings that are currently unavailable**.
5. Tap **Require a password (recommended)**.



**NOTE:** If you need to create a user account password or change your current user account password, tap **Create or change your user account password**, and then follow the on-screen instructions. If you do not need to create or change a user account password, go to step 5.

---

6. Tap **Save changes**.

## Using battery power

The tablet runs on battery power whenever it is not plugged into external AC power. Tablet battery life varies, depending on power management settings, programs running on the tablet, display brightness, external devices connected to the tablet, and other factors. When the tablet is plugged into AC power, the battery is charged and your work is protected in case of a power outage. If the battery is charged and the tablet is running on external AC power, the tablet automatically switches to battery power if the AC adapter is disconnected from the tablet or an AC power loss occurs.



**NOTE:** When you disconnect AC power, the display brightness is automatically decreased to save battery life. For more information, see [Using external AC power on page 39](#).

---

## Factory-sealed battery

To monitor the status of your battery, or if the battery is no longer holding a charge, run Battery Check in HP Support Assistant. To access battery information, tap the **HP Support Assistant** app on the Start screen, and then tap **Battery and performance**. If Battery Check indicates that your battery should be replaced, contact support.

The battery(ies) in this product cannot be easily replaced by users themselves. Removing or replacing the battery could affect your warranty coverage. If a battery is no longer holding a charge, contact support.

When a battery has reached the end of its useful life, do not dispose of the battery in general household waste. Follow the local laws and regulations in your area for battery disposal.

## Finding additional battery information

HP Support Assistant provides the tools and information about the battery. To access battery information, tap the **HP Support Assistant** app on the Start screen, and then tap **Battery and performance**.

- Battery Check tool to test battery performance
- Information on calibration, power management, and proper care and storage to maximize battery life
- Information on battery types, specifications, life cycles, and capacity

## Using Battery Check

HP Support Assistant provides information on the status of the battery installed in the tablet.

To run Battery Check:

1. Connect the AC adapter to the tablet.



**NOTE:** The tablet must be connected to external power for Battery Check to work properly.

2. To access battery information, tap the **HP Support Assistant** app on the Start screen, and then tap **Battery and performance**.

Battery Check examines the battery and its cells to see if they are functioning properly, and then reports the results of the examination.

## Displaying the remaining battery charge

- ▲ Tap the power meter icon on the Windows desktop in the notification area, at the far right of the taskbar.

## Maximizing battery discharge time

Battery discharge time varies depending on features you use while on battery power. Maximum discharge time gradually decreases as the battery storage capacity naturally degrades.

To maximize battery discharge time, lower the brightness on the display.

## Managing low battery levels

The information in this section describes the alerts and system responses set at the factory. Some low-battery alerts and system responses can be changed using Power Options. Preferences set using Power Options do not affect lights.

1. Swipe from the right edge of the touch screen to display the charms, tap **Search**, and then tap the search box.
2. In the search box, type `power`, and then tap **Power Options**.

## Identifying low battery levels

When a battery that is the sole power source for the tablet reaches a low or critical battery level, the following behavior occurs:

- On the Windows desktop, the power meter icon in the notification area shows a low or critical battery notification.



**NOTE:** For additional information about the power meter, see [Using the power meter and power settings on page 36](#).

If the tablet is on or in the Sleep state, the tablet remains briefly in the Sleep state and then shuts down and loses any unsaved information.

## Resolving a low battery level

### Resolving a low battery level when external power is available

- ▲ Connect one of the following devices:
  - AC adapter

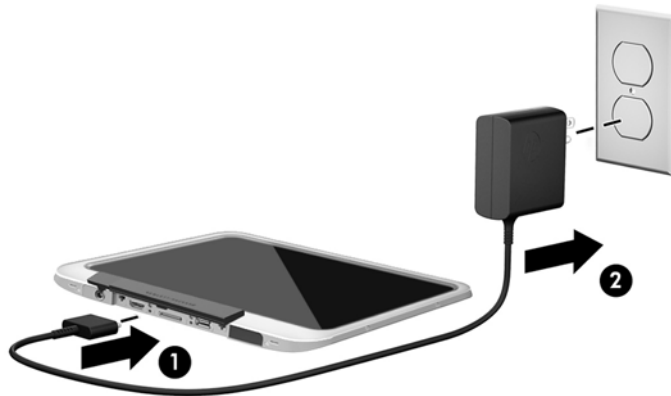

- Optional docking or expansion device



- Optional power adapter purchased as an accessory from HP

## Resolving a low battery level when no power source is available

To resolve a low battery level when no power source is available, save your work and shut down the tablet.

## Conserving battery power

- Swipe from the right edge of the touch screen to display the charms, tap **Search**, and then tap the search box. In the search box, type `power`, tap **Settings**, and then tap **Power Options**.
- Select low power-use settings through Power Options.
- Turn off wireless and LAN connections when you are not using them.
- Disconnect unused external devices that are not plugged into an external power source.
- Stop, disable, or remove any external media cards that you are not using.
- Decrease screen brightness.
- Before you leave your work, initiate Sleep, or shut down the tablet.

## Using external AC power

---

 **WARNING!** Do not charge the tablet battery while you are onboard aircraft.

 **WARNING!** To reduce potential safety issues, use only the AC adapter provided with the tablet, a replacement AC adapter provided by HP, or a compatible AC adapter purchased from HP.

 **NOTE:** For information on connecting to AC power, see the *Setup Instructions* poster provided in the tablet box.

---

External AC power is supplied through an approved AC adapter or an optional docking or expansion device.

Connect the tablet to external AC power under any of the following conditions:

- When charging a battery
- When installing or modifying system software
- When running Disk Defragmenter
- When performing a backup or recovery

When you connect the tablet to external AC power, the following events occur:

- The battery begins to charge.
- If the tablet is turned on, the power meter icon in the notification area changes appearance.

When you disconnect external AC power, the following events occur:

- The tablet switches to battery power.
- The display brightness is automatically decreased to save battery life.

---

# 7 External cards and devices

## Using smart cards

 **NOTE:** The term *smart card* is used throughout this chapter to mean both smart cards and Java™ Cards.

A smart card is a credit card-sized accessory that carries a microchip containing memory and a microprocessor. Like personal computers, smart cards have an operating system to manage input and output, and they include security features to protect against tampering. Industry-standard smart cards are used with the smart card reader.

A PIN is needed to gain access to the contents of the microchip. For more information about smart card security features, access HP Support Assistant. To access HP Support Assistant on the Start screen, select the **HP Support Assistant** app.

### Inserting a smart card

1. Gently lift the I/O door on the back of the tablet to open it.
2. Hold the card label-side up, and gently slide the card into the smart card reader slot until the card is seated.

 **TIP:** When the card is fully seated, the smart card light turns on.



3. Close the I/O door.
4. Follow the on-screen instructions for logging on to the tablet using the smart card PIN.



## Removing a smart card

1. Gently lift the I/O door on the back of the tablet to open it.
2. Grasp the edge of the smart card, and then slide it out of the smart card reader.
3. Close the I/O door.

## Using a USB device

Universal Serial Bus (USB) is a hardware interface that can be used to connect an optional external device, such as a USB keyboard, mouse, drive, printer, scanner, or hub.

Some USB devices may require additional support software, which is usually included with the device. For more information about device-specific software, see the manufacturer's instructions. These instructions may be provided with the software, on disc, or on the manufacturer's website.

The tablet has one USB port that supports USB 1.0, 1.1, 2.0, or 3.0 devices. An optional docking device or USB hub provides additional USB ports that can be used with the tablet.

## Connecting a USB device

---

**CAUTION:** To reduce the risk of damage to a USB connector, use minimal force to connect the device.

---

- ▲ After opening the I/O door at the bottom of the tablet, connect the USB cable for the device to the USB port.

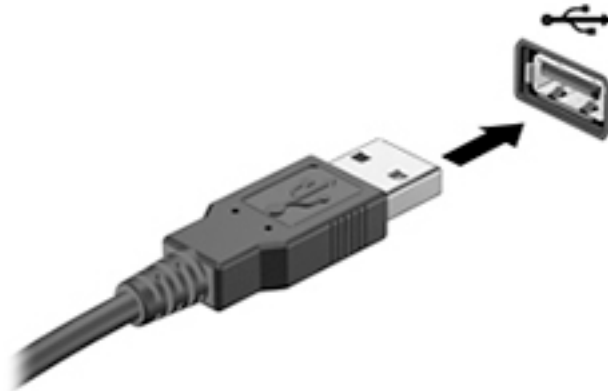

You will hear a sound when the device has been detected.

---

**NOTE:** The first time you connect a USB device, a message in the notification area lets you know that the device is recognized by the tablet.

---

## Removing a USB device

---

**CAUTION:** To reduce the risk of damage to a USB connector, do not pull on the cable to remove the USB device.

**CAUTION:** To reduce the risk of loss of information or an unresponsive system, use the following procedure to safely remove the USB device.

---

1. To remove a USB device, save your information and close all programs associated with the device.
2. Click the remove hardware icon on the Windows desktop in the notification area, at the far right of the taskbar, and then follow the on-screen instructions.
3. Remove the device.

## Connecting a stylus

To connect a stylus to the tablet, follow the stylus manufacturer's instructions for downloading software and drivers, if necessary.

To store the stylus:

1. Connect the included stylus holder to the tablet.

 **NOTE:** The stylus holder is not reversible. Verify that you have attached it correctly before continuing.

2. Connect the stylus (not included) to the stylus holder.

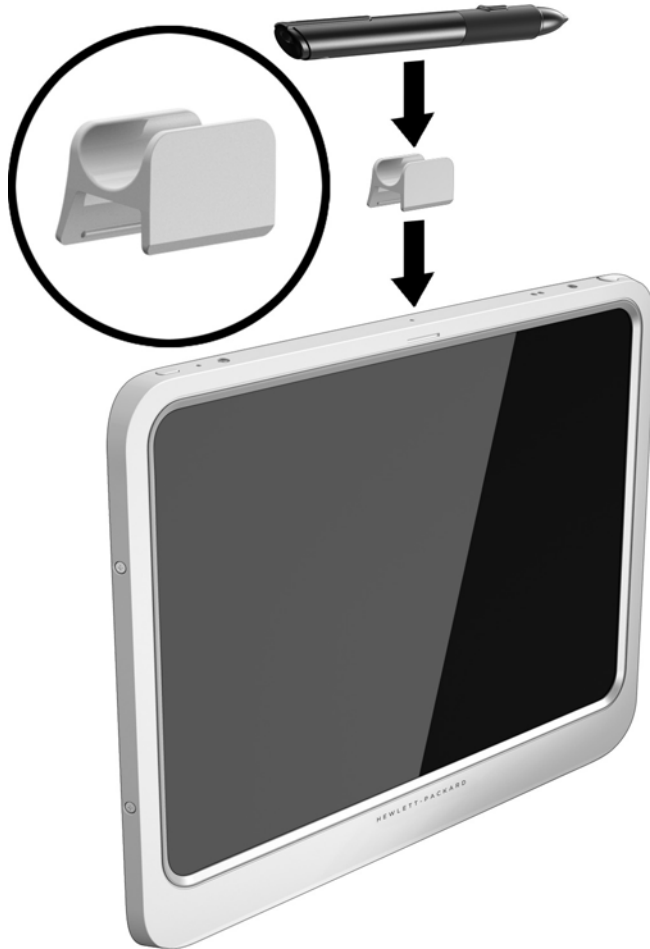

To store a stylus using a lanyard:

1. Insert the bottom loop of the lanyard through the stylus connector **(1)**.

2. Insert the rest of the lanyard through the bottom loop **(2)**, and then pull the lanyard away from the loop to secure it **(3)**.

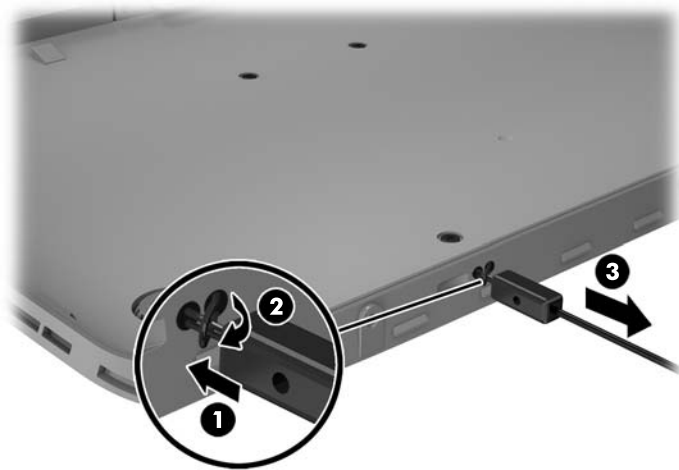

## Using optional external devices

 **NOTE:** For more information about required software and drivers, or to learn which port to use, see the manufacturer's instructions.

To connect an external device to the tablet:

 **CAUTION:** To reduce the risk of damage to the equipment when connecting a powered device, be sure that the device is turned off and the AC power cord is unplugged.

1. Connect the device to the tablet.
2. If you are connecting a powered device, plug the device power cord into a grounded AC outlet.
3. Turn on the device.

To disconnect an unpowered external device, turn off the device, and then disconnect it from the tablet. To disconnect a powered external device, turn off the device, disconnect it from the tablet, and then unplug the AC power cord.

## Using optional external drives

Removable external drives expand your options for storing and accessing information. A USB drive can be added by connecting the drive to a USB port on the tablet.

 **NOTE:** HP external USB optical drives should be connected only to powered USB ports; therefore, HP does not recommend connecting HP external USB optical drives to the tablet.

USB drives include the following types:

- 1.44-megabyte diskette drive
- Hard drive module
- External optical drive (CD, DVD, and Blu-ray)
- MultiBay device

## Installing an optional security cable

 **NOTE:** A security cable is designed to act as a deterrent, but it may not prevent the tablet from being mishandled or stolen.

 **NOTE:** The security cable slot on your tablet might look slightly different from the illustration in this section. See [Getting to know your tablet on page 4](#) for the location of the security cable slot on your tablet.



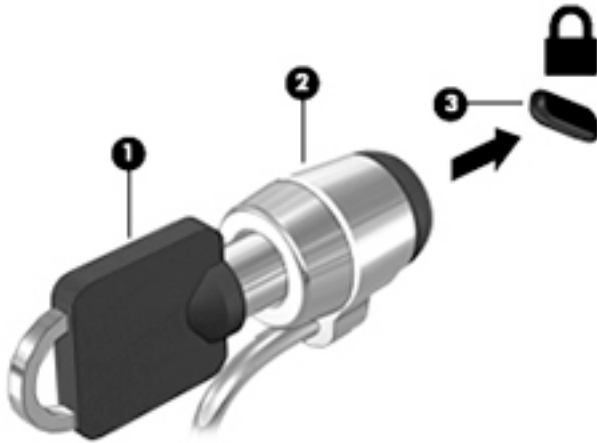

1. Lift the edge of the security cable slot dust cover that has a rectangular indentation.
2. Loop the security cable around a secured object.
3. Insert the key (1) into the cable lock (2).
4. Insert the cable lock into the security cable slot on the tablet (3), and then lock the cable lock with the key.



# 8 Security

## Protecting the tablet

Standard security features provided by the Windows operating system and Computer Setup can protect your personal settings and data from a variety of risks.

-  **NOTE:** Security solutions are designed to act as deterrents. These deterrents may not prevent a product from being mishandled or stolen.
-  **NOTE:** Before you send your tablet for service, back up and delete confidential files, and remove all password settings.
-  **NOTE:** Some features listed in this chapter may not be available on your tablet.
-  **NOTE:** Your tablet supports Absolute Data Protect. If your tablet is lost or stolen, it can be located and locked, and personal data can be deleted from a remote location. The tablet must be connected to the Internet.

Tablet risk	Security feature
Unauthorized use of the tablet	HP Client Security, in combination with a password or other authentication credential
Unauthorized access to Computer Setup and other system identification information	BIOS administrator password in Computer Setup
Unauthorized startup from an optional external flash drive	Boot options feature in Computer Setup
Unauthorized access to a Windows user account	Windows user password
Unauthorized access to data	<ul style="list-style-type: none"><li>• HP Drive Encryption software</li><li>• Windows Defender</li></ul>

## Using passwords

A password is a group of characters that you choose to secure your tablet information. Several types of passwords can be set, depending on how you want to control access to your information. Passwords can be set in Windows or in Computer Setup that is preinstalled on the tablet.

- Setup passwords are set in Computer Setup and are managed by the system BIOS.
- Windows passwords are set only in the Windows operating system.

Use the following tips for creating and saving passwords:

- When creating passwords, follow requirements set by the program.
- Do not use the same password for multiple applications or websites, and do not reuse your Windows password for any other application or website.
- Use HP Password Manager to store all of your user names and passwords for all of your websites and applications. You can securely read them in the future if they cannot be remembered.
- Do not store passwords in a file on the tablet.

The following tables list commonly used Windows and BIOS administrator passwords and describe their functions.

## Setting passwords in Windows

Password	Function
Administrator password*	Protects access to a Windows administrator-level account. <b>NOTE:</b> Setting the Windows Administrator password does not set the BIOS Administrator password.
User password*	Protects access to a Windows user account.

\*For information about setting a Windows administrator password or a Windows user password, access HP Support Assistant. To access HP Support Assistant, on the Start screen, tap the **HP Support Assistant** app.

## Setting passwords in Computer Setup

Password	Function
BIOS administrator password	Protects access to Computer Setup.

## Using antivirus software

When you use the tablet to access email, a network, or the Internet, you potentially expose it to computer viruses. Computer viruses can disable the operating system, programs, or utilities, or cause them to function abnormally.

Antivirus software can detect most viruses, destroy them, and, in most cases, repair any damage they have caused. To provide ongoing protection against newly discovered viruses, antivirus software must be kept up to date.

Windows Defender, which includes antivirus features, is preinstalled on your tablet. It is strongly recommended that you continue to use an antivirus program in order to fully protect your tablet.

For more information about viruses, access HP Support Assistant. To access HP Support Assistant, on the Start screen, tap the **HP Support Assistant** app.

## Using firewall software

Firewalls are designed to prevent unauthorized access to a system or network. A firewall can be a software program you install on your tablet and/or network, or it can be a solution made up of both hardware and software.

There are two types of firewalls to consider:

- Host-based firewalls—Software that protects only the computer it is installed on.
- Network-based firewalls—Installed between your DSL or cable modem and your home network to protect all the computers on the network.

When a firewall is installed on a system, all data sent to and from the system is monitored and compared with a set of user-defined security criteria. Any data that does not meet those criteria is blocked.

Windows Defender is installed on your tablet.



**NOTE:** Under some circumstances a firewall can block access to Internet games, interfere with printer or file sharing on a network, or block authorized email attachments. To permanently resolve the problem, reconfigure the firewall. To temporarily resolve the problem, disable the firewall, perform the task that you want to perform, and then reenable the firewall.

## Installing critical security updates



**CAUTION:** Microsoft sends out alerts regarding critical updates. To protect the tablet from security breaches and computer viruses, install all critical updates from Microsoft as soon as you receive an alert.

You can choose whether updates are installed automatically. To change the settings, on the Start screen, swipe from the right side of the screen, tap **Settings**, and then tap **Control Panel**. Tap **System and Security**, tap **Windows Update**, tap **Change settings**, and then follow the on-screen instructions.

## Using HP Client Security

HP Client Security software is preinstalled on your tablet. This software can be accessed through the HP Client Security tile on the Start screen, the icon on the Windows desktop in the notification area, at the far right of the taskbar, and Windows Control Panel. It provides security features that help protect against unauthorized access to the tablet, networks, and critical data. For more information, see the HP Client Security software Help.



---

## 9 Maintenance

### IP-54 rating

This tablet is rated IP-54, which means that it is protected against dust and splashing water.

To maintain the IP-54 rating, close the audio-out (headphone)/audio-in (microphone) combo jack and all I/O doors.

To close the bottom I/O door:

1. Insert the bottom edge of the I/O door beneath the front edge of the tablet **(1)**, and then press the door to close it **(2)**.



2. Press the door on each side as well as the middle to ensure that there is a good seal. Visually confirm that it is fully closed.



## Cleaning your tablet

Your tablet is treated with Sureshield, an antimicrobial agent which helps protect the tablet. The quick release pins, camera lens, camera flash cover, bar-code scanner cover, screws, screen, and HP logo are not treated with Sureshield.

To preserve the antimicrobial coating, store your tablet in a cool, dry place and do not freeze it. Avoid heat, sparks, open flame, strong acids, ammonia, oxidizing agents, carbon monoxide, and carbon dioxide.

Use one of the following chemical mixtures to safely clean your tablet:

- Benzyl-C12-18-alkyldimethyl ammonium chlorides <1% with quaternary ammonium compounds, C12-14-alkyl[(ethylphenyl)methyl]dimethyl, chlorides <1%
- Isopropanol 10%–20%, 2-Butoxyethanol 1%–4%, benzyl-C12-18-alkyldimethyl ammonium chlorides <0.125%, and quaternary ammonium compounds, C12-18-alkyl [(ethylphenyl) methyl] dimethyl, chlorides <0.125%
- Isopropanol 30%–60%, benzyl-C12-18-alkyldimethyl ammonium chlorides 0.1%–1%, and quaternary ammonium compounds, C12-18-alkyl [(ethylphenyl) methyl] dimethyl 0.1%–1%
- Isopropyl alcohol wipes (Isopropyl alcohol 70%)
- Isopropanol 10%–20% and ethylene glycol monobutyl ether 1%–5%
- n-Alkyl dimethyl benzyl ammonium chloride 5%–10%, didecyl dimethyl ammonium chloride 5%–10%, ethyl alcohol 1%–5%, and lauryl dimethyl amine oxide 0.1%–1.5%
- n-Alkyl dimethyl benzyl ammonium chloride 0.2%–0.4% with lauramine oxide 0.5%–1.5%
- Ethylene glycol n-hexyl ether 0.1%–1.0%, isopropanol 1%–5%, and water 90%–95%
- Sodium hypochlorite 1%–5% with sodium hydroxide 0.5%–2%
- Gentle dish soap and water
- Dry microfiber cleaning cloth or a chamois (static-free cloth without oil)
- Static-free cloth wipes

---

**⚠ CAUTION:** The common hospital cleaning agents listed previously were successfully tested with this product. Cleaning solvents other than those on this list may damage your tablet.

Fibrous materials, such as paper towels, can scratch the tablet. Over time, dirt particles and cleaning agents can get trapped in the scratches.

---

## Cleaning procedures

Follow the procedures in this section to safely clean your tablet.

---

**⚠ WARNING!** To prevent electric shock or damage to components, do not attempt to clean your tablet while it is on.

Turn off the tablet.

Disconnect AC power.

Disconnect all powered external devices.

**⚠ CAUTION:** To prevent damage to internal components, do not spray cleaning agents or liquids directly on any tablet port surface. Liquids dripped on the surface can permanently damage internal components. Close all ports and I/O doors.

---

## Cleaning the display

Gently wipe the display using a soft, lint-free cloth moistened with an *alcohol-free* glass cleaner. Be sure that the display is dry before storing the tablet.

## Cleaning the tablet

To clean the tablet, use a soft microfiber cloth or chamois moistened with one of the cleaning solutions listed previously or use an acceptable disposable wipe.



---

**NOTE:** When cleaning the tablet, use a circular motion to aid in removing dirt and debris.

---

## Updating programs and drivers

HP recommends that you update your programs and drivers on a regular basis with the latest versions. Go to <http://www.hp.com/support> to download the latest versions. You can also register to receive automatic update notifications when they become available.

## Using SoftPaq Download Manager

HP SoftPaq Download Manager (SDM) is a tool that provides quick access to SoftPaq information for HP business tablets without requiring the SoftPaq number. Using this tool, you can easily search for SoftPaqs, and then download and unpack them.

SoftPaq Download Manager works by reading and downloading, from the HP FTP site, a published database file containing tablet model and SoftPaq information. SoftPaq Download Manager allows you to specify one or more tablet models to determine which SoftPaqs are available for download.

SoftPaq Download Manager checks the HP FTP site for updates to the database and software. If updates are found, they are downloaded and applied automatically.

SoftPaq Download Manager is available on the HP website. To use SoftPaq Download Manager to download SoftPaqs, you must first download and install the program. Go to the HP website at <http://www.hp.com/go/sdm>, and then follow the instructions to download and install SoftPaq Download Manager.

To download SoftPaqs:

1. Swipe from the right edge of the touch screen to display the charms, tap **Search**, and then tap the search box.
2. In the search box, type `softpaq`, and then tap HP SoftPaq Download Manager. Follow the instructions to download SoftPaqs.



---

**NOTE:** If prompted by User Account Control, tap **Yes**.

---

---

## 10 Backup and recovery

To protect your information, use Windows backup and restore utilities to back up individual files and folders, back up your entire hard drive, create system repair media (select models only) by using an optional external flash drive, or an optional external optical drive, or create system restore points. In case of system failure, you can use the backup files to restore the contents of your tablet.

1. Swipe from the right edge of the touch screen to display the charms, tap **Search**, and then tap the search box.
2. In the search box, type `restore`, and then select from the list of displayed options.

---

 **NOTE:** For detailed instructions on various backup and restore options, perform a search for these topics in Windows Help and Support.

In case of system instability, HP recommends that you print the recovery procedures and save them for later use.

 **NOTE:** Windows includes the User Account Control feature to improve the security of your tablet. You may be prompted for your permission or password for tasks such as installing software, running utilities, or changing Windows settings. For more information, see Windows Help and Support.

---

### Backing up your information

Recovery after a system failure is as good as your most recent backup. You should create system repair media and your initial backup immediately after initial system setup. As you add new software and data files, you should continue to back up your system on a regular basis to maintain a reasonably current backup.

For more information on the Windows backup features, see Windows Help and Support.

### Performing a system recovery

In case of system failure or instability, the tablet provides the following tools to recover your files:

- Windows recovery tools: You can use Windows Backup and Restore to recover information you have previously backed up. You can also use Windows Automatic Repair to fix problems that might prevent Windows from starting correctly.
- **f11** recovery tools: You can use the **f11** recovery tools to recover your original hard drive image. The image includes the Windows operating system and software programs installed at the factory.

---

 **NOTE:** If you are unable to boot (start up) your tablet and you cannot use the system repair media you previously created (select models only), contact support.

---

### Using the Windows recovery tools

To recover information you previously backed up, see Windows Help and Support for steps on restoring files and folders.

To recover your information using Automatic Repair, follow these steps:

---

 **CAUTION:** Some Startup Repair options will completely erase and reformat the hard drive. All files you have created and any software installed on the tablet are permanently removed. When reformatting is complete, the recovery process restores the operating system, as well as the drivers, software, and utilities from the backup used for recovery.

 **NOTE:** An external keyboard, mouse, and external flash drive may be required to perform this procedure.

---

1. If possible, back up all personal files.
2. If possible, check for the presence of the Recovery Image partition and the Windows partition. Swipe from the right edge of the touch screen, tap **Search**, and then tap the search box. Type `file`, and then tap **File Explorer**.
3. If the Windows partition and the Recovery Image partition are listed, shut down the tablet.
4. To power on the tablet, press the **Power** button and **Volume down** button simultaneously. The Startup menu is displayed.
5. Select **Troubleshoot**, select **Advanced Options**, and then select **Startup Repair**.
6. Follow the on-screen instructions.

 **NOTE:** For additional information on recovering information using the Windows tools, perform a search for these topics in Windows Help and Support.

---

## Using f11 recovery tools

 **CAUTION:** Using **f11** completely erases hard drive contents and reformats the hard drive. All files that you have created and any software that you have installed on the tablet are permanently removed. The **f11** recovery tool reinstalls the operating system, drivers, Windows updates, and language packs that were installed at the factory. All other software applications must be downloaded from HP.com or the Windows Store.

 **NOTE:** An external keyboard, mouse, and external flash drive may be required to perform this procedure.

---

To recover the original hard drive image using **f11**:

1. If possible, back up all personal files.
2. If possible, check for the presence of the HP Recovery partition: Swipe from the right edge of the touch screen, tap **Search**, and then tap the search box. Type `pc`, and then tap **This PC**.
3. If the HP Recovery partition is listed, shut down the tablet.
4. To power on the tablet, press the **Power** button and **Volume down** button simultaneously. The Startup menu is displayed.
5. Tap **F11 HP Recovery**, and then follow the on-screen instructions.

## Changing the boot device order

To change the boot order so that you can boot from an external device:

 **NOTE:** An external flash drive is required to perform this procedure.

---

1. If possible, back up all personal files.
2. Shut down the tablet.
3. Connect the external flash drive.

4. To power on the tablet, press the **Power** button and **Volume down** button simultaneously.  
The Startup menu is displayed.
5. Tap **F9 Boot Options**.
6. Select the external flash drive as the boot device.
7. Restart the tablet.

## Using Windows Refresh or Windows Reset

When your tablet is not working properly and you need to regain system stability, the Windows Refresh option allows you to start fresh and keep what is important to you.

The Windows Reset option allows you to perform detailed reformatting of your tablet, or remove personal information before you give away or recycle your tablet. For more information on these features, see Windows Help and Support.

---

# 11 Computer Setup and HP PC Hardware Diagnostics (UEFI)

## Using Computer Setup

Computer Setup, or F10 BIOS Setup (Basic Input/Output System), controls communication between all the input and output devices on the system (such as disk drives, display, keyboard, mouse, and printer). Computer Setup includes settings for the types of devices installed, the startup sequence of the tablet, and the amount of system and extended memory.



**NOTE:** Use extreme care when making changes in Computer Setup. Errors can prevent the tablet from operating properly.

---

## Starting Computer Setup

To start Computer Setup, follow these steps:

1. Shut down the tablet.
2. To power on the tablet, press the **Power** button and **Volume down** button simultaneously.  
The Startup menu is displayed.
3. Press **f10** to enter Computer Setup.

## Navigating and selecting in Computer Setup

To navigate and select in Computer Setup, follow these steps:

1. Shut down the tablet.
2. To power on the tablet, press the **Power** button and **Volume down** button simultaneously.  
The Startup menu is displayed.
3. Press **f10** to enter Computer Setup.
  - Tap a menu or a menu item to select it.
  - To close open dialog boxes and return to the main Computer Setup screen, tap **Escape**, and then follow the on-screen instructions.
4. To exit Computer Setup menus without saving your changes, select **Main**, select **Ignore Changes and Exit**, and then follow the on-screen instructions.
5. To save your changes and exit, select **Main**, select **Save Changes and Exit**, and then follow the on-screen instructions.

## Restoring factory settings in Computer Setup



**NOTE:** Restoring defaults will not change the hard drive mode.

---

To return all settings in Computer Setup to the values that were set at the factory, follow these steps:

1. Shut down the tablet.
2. To power on the tablet, press the **Power** button and **Volume down** button simultaneously.  
The Startup menu is displayed.
3. Press **f10** to enter Computer Setup.
4. Select **Main**, and then tap **Restore Defaults**.
5. Follow the on-screen instructions.
6. To save your changes and exit, select **Save Changes and Exit**, and then follow the on-screen instructions.

Your changes go into effect when the tablet restarts.



**NOTE:** Your password settings and security settings are not changed when you restore the factory settings.

## Updating the BIOS

Updated versions of the BIOS may be available on the HP website.

Most BIOS updates on the HP website are packaged in compressed files called *SoftPaqs*.

Some download packages contain a file named *Readme.txt*, which contains information regarding installing and troubleshooting the file.

## Determining the BIOS version

To determine whether available BIOS updates contain later BIOS versions than those currently installed on the tablet, you need to know the version of the system BIOS currently installed.

To display BIOS version information (also known as *ROM date* and *System BIOS*), see [Using Computer Setup on page 55](#).

1. Shut down the tablet.
2. To power on the tablet, press the **Power** button and **Volume down** button simultaneously.  
The Startup menu is displayed.
3. Press **f10** to enter Computer Setup.
4. Select **Main**, and then select **System Information**.
5. Follow the on-screen instructions.
6. To exit Computer Setup menus without saving your changes, select **Main**, select **Ignore Changes and Exit**, and then follow the on-screen instructions.



## Downloading a BIOS update

 **CAUTION:** To reduce the risk of damage to the tablet or an unsuccessful installation, download and install a BIOS update only when the tablet is connected to reliable external power using the AC adapter. Do not download or install a BIOS update while the tablet is running on battery power, docked in an optional docking device, or connected to an optional power source. During the download and installation, follow these instructions:

Do not disconnect power on the tablet by unplugging the power cord from the AC outlet.

Do not shut down the tablet or initiate Sleep.

Do not insert, remove, connect, or disconnect any device, cable, or cord.

1. To access HP Support Assistant on the Start screen, tap the **HP Support Assistant** app.
2. Tap **Updates and tune-ups**, and then tap **Check for HP updates now**.
3. Follow the on-screen instructions.
4. At the download area, follow these steps:
  - a. Identify the most recent BIOS update and compare it to the BIOS version currently installed on your tablet. Make a note of the date, name, or other identifier. You may need this information to locate the update later, after it has been downloaded to your hard drive.
  - b. Follow the on-screen instructions to download your selection to the hard drive.

If the update is more recent than your BIOS, make a note of the path to the location on your hard drive where the BIOS update is downloaded. You will need to access this path when you are ready to install the update.

 **NOTE:** If you connect your tablet to a network, consult the network administrator before installing any software updates, especially system BIOS updates.

BIOS installation procedures vary. Follow any instructions that are revealed on the screen after the download is complete. If no instructions are revealed, follow these steps:

1. Swipe from the right edge of the touch screen, tap **Search**, and then tap the search box. Type *file*, and then tap **File Explorer**.
2. Select your hard drive designation. The hard drive designation is typically Local Disk (C:).
3. Using the hard drive path you recorded earlier, open the folder on your hard drive that contains the update.
4. Double-tap the file that has an .exe extension (for example, filename.exe).

The BIOS installation begins.
5. Complete the installation by following the on-screen instructions.

 **NOTE:** After a message on the screen reports a successful installation, you can delete the downloaded file from your hard drive.

## Using HP PC Hardware Diagnostics (UEFI)

HP PC Hardware Diagnostics is a Unified Extensible Firmware Interface (UEFI) that allows you to run diagnostic tests to determine if the tablet hardware is functioning properly. The tool runs outside of the operating system to isolate hardware failures from issues that may be caused by the operating system or other software components.

To start HP PC Hardware Diagnostics UEFI:

1. Shut down the tablet if it is not already powered off
2. To power on the tablet, press the **Power** button, and then press the **Volume down** button.
3. Select **System Diagnostics**.
4. Select the type of diagnostic test that you want to run, and then follow the on-screen instructions.



---

**NOTE:** If you need to stop a diagnostic test while it is running, press anywhere on the screen.

---

# 12 Specifications

## Input power

The power information in this section may be helpful if you plan to travel internationally with the tablet.

The tablet operates on DC power, which can be supplied by an AC or a DC power source. The AC power source must be rated at 100–240 V, 50–60 Hz. Although the tablet can be powered from a standalone DC power source, it should be powered only with an AC adapter or a DC power source supplied and approved by HP for use with this tablet.

The tablet can operate on DC power within the following specifications.

Input Power	Rating
Operating voltage and current	9 V DC @ 1.1A – 10W

 **NOTE:** This product is designed for IT power systems in Norway with phase-to-phase voltage not exceeding 240 V rms.

 **NOTE:** The tablet operating voltage and current can be found on the system regulatory label.

## Operating environment

Factor	Metric	U.S.
<b>Temperature</b>		
Operating (writing to optical disc)	<b>5°C to 35°C</b>	41°F to 95°F
Nonoperating	<b>-20°C to 60°C</b>	-4°F to 140°F
<b>Relative humidity</b> (noncondensing)		
Operating	<b>10% to 90%</b>	10% to 90%
Nonoperating	<b>5% to 95%</b>	5% to 95%
<b>Maximum altitude</b> (unpressurized)		
Operating	<b>-15 m to 3,048 m</b>	-50 ft to 10,000 ft
Nonoperating	<b>-15 m to 12,192 m</b>	-50 ft to 40,000 ft

## EN 60601-1-2: 2007

The HP ElitePad 1000 G2 Healthcare Tablet needs special precautions regarding EMC and needs to be used according to the EMC information provided in this document.

 **WARNING!** Portable and mobile RF communications equipment can affect the HP ElitePad 1000 G2 Healthcare Tablet.

## Accessories and cables

**⚠ WARNING!** Use of accessories, transducers and cables other than those specified or provided by the manufacturer of this equipment could result in increased electromagnetic emissions or decreased electromagnetic immunity of this equipment and result in improper operation.

Port type	Name/description
HDMI	Display/monitor
USB	USB keyboard
USB	USB mouse
USB	External HDD (USB 2.0)
Audio	Headphone/microphone
Smart card slot	Smart card

Port type	Name/description	Manufacturer	Model number
Dock	HP ElitePad Docking Station	HP	HP ElitePad Docking Station
Dock PSU	HP AC/DC Power Supply for Dock	HP	HSTNN-DA35
AC/DC PSU	HP AC/DC Power Supply	Delta Electronics, Inc.	HSTNN-DA34

**Table 12-1** Ports and cabling – Standalone

Port name on EUT	Cable description (or reason for no cables)	Qty	Length as tested (m)	Max length (m)	Shielded? (Y/N)	Termination box ID & port name
AC Input	AC/DC adapter	1	2.0	>3.0	No	Input Power
HDMI	HDMI	1	2.0	>3.0	No	Monitor
USB	USB port	1	0.5	>3.0	No	HDD

**Table 12-2** Ports and cabling – Docked

Port name on EUT	Cable description (or reason for no cables)	Qty	Length as tested (m)	Max length (m)	Shielded? (Y/N)	Termination box ID & port name
AC Input–Dock	AC/DC adapter	1	4.0	>3.0	No	Input Power
HDMI	HDMI	1	2.0	>3.0	No	Monitor
USB	USB port	2	0.5	>3.0	No	HDD
USB	Keyboard	1	2.0	>3.0	No	Keyboard
USB	Mouse	1	2.0	>3.0	No	Mouse
Line Out	3.5 mm	1	2.0	>3.0	No	Headphone

**Table 12-2 Ports and cabling – Docked (continued)**

Port name on EUT	Cable description (or reason for no cables)	Qty	Length as tested (m)	Max length (m)	Shielded? (Y/N)	Termination box ID & port name
LAN	Ethernet	1	2.0	>3.0	No	Switch
VGA	VGA	1	1.0	>3.0	No	Monitor

## Electromagnetic emissions

### Guidance and manufacturer's declaration—electromagnetic emissions

The HP ElitePad 1000 G2 Healthcare Tablet is intended for use in the electromagnetic environment specified below. The customer or the user of the HP ElitePad 1000 G2 Healthcare Tablet should assure that it is used in such an environment.

Emissions test	Compliance	Electromagnetic environment—guidance
RF emissions CISPR 11	Group 1	The ElitePad 1000 G2 uses RF energy only for its internal function. Therefore, its RF emissions are very low and are not likely to cause any interference in nearby electronic equipment.
RF emissions CISPR 11	Class B	The ElitePad 1000 G2 is suitable for use in all establishments, including domestic establishments and those directly connected to the public low-voltage power supply network that supplies buildings used for domestic purposes.
Harmonic emissions IEC 61000-3-2	Class D	
Voltage fluctuations/flicker emissions IEC 61000-3-3	Class Complies	

**⚠ WARNING!** Use of this equipment adjacent to or stacked with other equipment should be avoided because it could result in improper operation. If such use is necessary, this equipment and the other equipment should be observed to verify that they are operating normally.

### Guidance and manufacturer's declaration—electromagnetic immunity

The HP ElitePad 1000 G2 Healthcare Tablet is intended for use in the electromagnetic environment specified below. The customer or the user of the HP ElitePad 1000 G2 Healthcare Tablet should assure that it is used in such an environment.

Immunity test	IEC 60601 test level	Compliance level	Electromagnetic environment—guidance
Electrostatic discharge (ESD) IEC 61000-4-2	± 6 kV contact ± 8 kV air	± 8 kV contact ± 2, 4, 8, 15 air	Floors should be wood, concrete, or ceramic tile. If floors are covered with synthetic material, the relative humidity should be at least 30%.
Electrical fast transient/burst IEC 61000-4-4	± 2 kV for power supply lines ± 1 kV for input/output lines	± 2 kV for power supply lines ± 1 kV for input/output lines	Mains power quality should be that of a typical commercial or hospital environment.
Surge IEC 61000-4-5	± 1 kV line(s) to line(s) ± 2 kV line(s) to earth	± 0.5 kV, ± 1 kV line(s) to line(s)	Mains power quality should be that of a typical commercial or hospital environment.

**Guidance and manufacturer's declaration—electromagnetic immunity**

		± 0.5 kV, ± 1 kV, ± 2 kV line(s) to earth	
Voltage dips, short interruptions, and voltage variations on power supply input lines  IEC 61000-4-11	<5 % U <sub>T</sub> (>95 % dip in U <sub>T</sub> ) for 0.5 cycle	0% U <sub>T</sub> (100 % dip in U <sub>T</sub> ) for 0.5 cycle	Mains power quality should be that of a typical commercial or hospital environment. If the user of the HP ElitePad 1000 G2 Healthcare Tablet requires continued operation during power mains interruptions, it is recommended that the HP ElitePad 1000 G2 Healthcare Tablet be powered from an uninterruptible power supply or battery.
	40 % U <sub>T</sub> (60 % dip in U <sub>T</sub> ) for 5 cycles	At 0°, 45°, 90°, 135°, 180°, 225°, 270° and 315°	
	70 % U <sub>T</sub> (30 % dip in U <sub>T</sub> ) for 25 cycles	40 % U <sub>T</sub> (60 % dip in U <sub>T</sub> ) for 5 cycles	
	<5 % U <sub>T</sub> (>95 % dip in U <sub>T</sub> ) for 5 s	70 % U <sub>T</sub> (30 % dip in U <sub>T</sub> ) for 25/30 cycles	
		0% U <sub>T</sub> (100 % dip in U <sub>T</sub> ) for 250/300 cycle	
		0% U <sub>T</sub> (100 % dip in U <sub>T</sub> ) for 1 cycle	
Power frequency (50/60 Hz) magnetic field  IEC 61000-4-8	3 A/m	30 A/m  50 Hz and 60 Hz	Power frequency magnetic fields should be at levels characteristic of a typical location in a typical commercial or hospital environment.

**NOTE:** U<sub>T</sub> is the AC mains voltage prior to application of the test level.

Because there can be many different applications/uses of the tablet, the Essential Performance is not determined at this time and will be defined by the end user.

**Guidance and manufacturer's declaration—electromagnetic immunity**

The HP ElitePad 1000 G2 Healthcare Tablet is intended for use in the electromagnetic environment specified below. The customer or the user of HP ElitePad 1000 G2 Healthcare Tablet should assure that it is used in such an environment.

Immunity test	IEC 60601 test level	Compliance level	Electromagnetic environment—guidance
Conducted RF  IEC 61000-4-6	3 Vrms  150 kHz to 80 MHz	3 V	Portable and mobile RF communications equipment should be used no closer to any part of the HP ElitePad 1000 G2 Healthcare Tablet, including cables, than the recommended separation distance calculated from the equipment applicable to the frequency of the transmitter.
Radiated RF  IEC 61000-4-3	3 V/m  80 MHz to 2.5 GHz	10 V/m	

**Recommended separation distance**

$$d = \frac{3.5}{V_1} \sqrt{P} = \frac{3.5}{3} \sqrt{P} = 1.2\sqrt{P}$$

80 MHz to 800 MHz:

$$d = \frac{3.5}{E_1} \sqrt{P} = \frac{3.5}{10} \sqrt{P} = 0.35\sqrt{P}$$

800 MHz to 2.5 GHz:

**Guidance and manufacturer's declaration—electromagnetic immunity**

$$d = \frac{7}{E1} \sqrt{P} = \frac{7}{10} \sqrt{P} = 0.70\sqrt{P}$$

Where P is the maximum output power rating of the transmitter in watts (W) according to the transmitter manufacturer and d is the recommended separation distance in metres (m).

Field strengths from fixed RF transmitters, as determined by an electromagnetic site survey<sup>a</sup>, should be less than the compliance level in each frequency range.<sup>b</sup>

Interference may occur in the vicinity of equipment marked with the following symbol:



**NOTE:** At 80 MHz and 800 MHz, the higher frequency range applies.

**NOTE:** These guidelines may not apply in all situations. Electromagnetic propagation is affected by absorption and reflection from structures, objects and people.

<sup>a</sup> Field strengths from fixed transmitters, such as base stations for radio (cellular/cordless) telephones and land mobile radios, amateur radio, AM and FM radio broadcast and TV broadcast cannot be predicted theoretically with accuracy. To assess the electromagnetic environment due to fixed RF transmitters, an electromagnetic site survey should be considered. If the measured field strength in the location in which the HP ElitePad 1000 G2 Healthcare Tablet is used exceeds the applicable RF compliance level above, the HP ElitePad 1000 G2 Healthcare Tablet should be observed to verify normal operation. If abnormal performance is observed, additional measures may be necessary, such as re-orienting or relocating the HP ElitePad 1000 G2 Healthcare Tablet.

<sup>b</sup> Over the frequency range 150 kHz to 80 MHz, field strengths should be less than 3 V/m.

**Recommended separation distances between portable and mobile RF communications equipment and the HP ElitePad 1000 G2 Healthcare Tablet**

The HP ElitePad 1000 G2 Healthcare Tablet is intended for use in an electromagnetic environment in which radiated RF disturbances are controlled. The customer or the user of the HP ElitePad 1000 G2 Healthcare Tablet can help prevent electromagnetic interference by maintaining a minimum distance between portable and mobile RF communications equipment (transmitters) and the HP ElitePad 1000 G2 Healthcare Tablet as recommended below, according to the maximum output power of the communications equipment.

Rated maximum output power of transmitter (W)	Separation distance according to frequency of transmitter (m)		
	150 kHz to 80 MHz	80 MHz to 800 MHz	80 MHz to 800 MHz
	$d=1.20\sqrt{P}$	$d=0.35\sqrt{P}$	$d=0.70\sqrt{P}$
0.01	0.12	0.035	0.070
0.1	0.38	0.11	0.22
1	1.20	0.35	0.70
10	3.80	1.1	2.2
100	12	3.5	7.0

For transmitters rated at a maximum output power not listed above, the recommended separation distance d in metres (m) can be estimated using the equation applicable to the frequency of the transmitter, where P is the maximum output power rating of the transmitter in watts (W) according to the transmitter manufacturer.

**NOTE:** At 80 MHz and 800 MHz, the separation distance for the higher frequency range applies.

---

**Recommended separation distances between portable and mobile RF communications equipment and the HP ElitePad 1000 G2 Healthcare Tablet**

---

**NOTE:** These guidelines may not apply in all situations. Electromagnetic propagation is affected by absorption and reflection from structures, objects, and people.

---

## Radiofrequency bandwidths

Receiver technology	Frequency or frequency band of reception	Bandwidth
Bluetooth 4.0	2.4 GHz	2 MHz
Wifi 802.11 a/b/g/n	2.4 GHz and 5.0 GHz	20/40 MHz
NFC ISO18092, ISO14443A/B	13.553–13.567 MHz	14 kHz
LTE cat3	1900 MHz, 2100 MHz, 850 MHz, 2600 MHz, 1800 MHz, 900 MHz, 800 MHz LTE bands 1, 2, 3, 5, 7, 8, 20	20 MHz

---

**⚠ WARNING!** The HP ElitePad 1000 G2 Healthcare Tablet may be interfered with by other equipment, even if that other equipment complies with CISPR Emission requirements.

---

## Radiofrequency transmitter bands and ERP

Transmitter technology	Frequency or frequency band	ERP (Effective Radiated Power)	E.I.R.P.
Bluetooth 4.0	2.4 GHz	8.04 dBm	10.19 dBm
Wifi 802.11 a/b/g/n	2.4 GHz and 5.0 GHz	2.4 GHz: 17.39 dBm 5 GHz: 19.7 dBm	2.4 GHz: 19.54 dBm 5 GHz: 21.85 dBm
NFC ISO18092, ISO14443A/B	13.5 MHz	-43 dBm	-40.85 dBm
LTE cat3	2100 MHz, 1900 MHz, 1800 MHz, 1700 MHz, 850 MHz, 2500 MHz, 900 MHz, 800 MHz	B1: 25.19 dBm B2: 26.02 dBm B3: 24.17 dBm B5: 22.87 dBm B7: 21.63 dBm B8: 21.75 dBm B20: 22.87 dBm	B1: 27.34 dBm B2: 28.17 dBm B3: 26.32 dBm B5: 25.02 dBm B7: 23.78 dBm B8: 23.9 dBm B20: 25.02 dBm

---

## Emissions requirements of cables, transducers, and accessories

**⚠ WARNING!** Use of an accessory with the HP ElitePad 1000 G2 Healthcare Tablet other than those specified in the table above may result in increased Emissions or decreased Immunity of the HP ElitePad 1000 G2 Healthcare Tablet.

---



Port type	Name/description	Manufacturer	Model number
Dock	HP ElitePad Docking Station	HP	HP ElitePad Docking Station
Dock PSU	HP AC/DC Power Supply for Dock	HP	HSTNN-LA35
Dock PSU	HP AC/DC Power Supply for Dock	HP	HSTNN-DA35
AC/DC PSU	HP AC/DC Power Supply	Delta Electronics, Inc.	HSTNN-DA34

## IEC 60601-1-2: 2014

HP ElitePad 1000 G2 Healthcare Tablet is suitable for use in all establishments, including domestic establishments and those directly connected to the public low-voltage power supply network that supplies buildings used for domestic purposes.

Essential Performance is not determined at this time and will be defined by the end user. There could be many different applications/uses of the tablet.

Use of this equipment adjacent to or stacked with other equipment should be avoided because it could result in improper operation. If such use is necessary, this equipment and the other equipment should be observed to verify that they are operating normally.

## Accessories and cables

**⚠ WARNING!** Use of accessories, transducers and cables other than those specified or provided by the manufacturer of this equipment could result in increased electromagnetic emissions or decreased electromagnetic immunity of this equipment and result in improper operation.

Port type	Name/description
HDMI	Display/monitor
USB	USB keyboard
USB	USB mouse
USB	External HDD (USB 2.0)
Audio	Headphone/microphone
Smart card slot	Smart card

Port type	Name/description	Manufacturer	Model number
Dock	HP ElitePad Docking Station	HP	HP ElitePad Docking Station
Dock PSU	HP AC/DC Power Supply for Dock	HP	HSTNN-DA35
AC/DC PSU	HP AC/DC Power Supply	Delta Electronics, Inc.	HSTNN-DA34

Port name on EUT	Cable description (or reason for no cables)	Qty	Length as tested (m)	Max length (m)	Shielded? (Y/N)	Termination box ID & port name
AC Input	AC/DC adapter	1	2.0	>3.0	No	Input Power
HDMI	HDMI	1	2.0	>3.0	No	Monitor
USB	USB port	1	0.5	>3.0	No	HDD

Port name on EUT	Cable description (or reason for no cables)	Qty	Length as tested (m)	Max length (m)	Shielded? (Y/N)	Termination box ID & port name
AC Input–Dock	AC/DC adapter	1	4.0	>3.0	No	Input Power
HDMI	HDMI	1	2.0	>3.0	No	Monitor
USB	USB port	2	0.5	>3.0	No	HDD
USB	Keyboard	1	2.0	>3.0	No	Keyboard
USB	Mouse	1	2.0	>3.0	No	Mouse
Line Out	3.5 mm	1	2.0	>3.0	No	Headphone
LAN	Ethernet	1	2.0	>3.0	No	Switch
VGA	VGA	1	1.0	>3.0	No	Monitor

## Electromagnetic and radiofrequency emissions

**⚠ WARNING!** Portable RF communications equipment (including peripherals such as antenna cables and external antennas) should be used no closer than 30 cm (12 inches) to any part of the HP ElitePad 1000 G2 Healthcare Tablet including cables specified by the manufacturer. Otherwise, degradation of the performance of this equipment could result.

Emissions test	Level/Class	Compliance
RF emissions (Radiated) CISPR 11	Group 1	Compliant
RF emissions (Conducted) CISPR 11	Class B	Compliant
Harmonic emissions IEC 61000-3-2	Class D	Compliant
Voltage fluctuations/ flicker emissions IEC 61000-3-3	N/A	Compliant

### Guidance and manufacturer's declaration—electromagnetic immunity

The HP ElitePad 1000 G2 Healthcare Tablet is intended for use in the electromagnetic environment specified below. The customer or the user of the HP ElitePad 1000 G2 Healthcare Tablet should assure that it is used in such an environment.

<b>Guidance and manufacturer's declaration—electromagnetic immunity</b>			
<b>Immunity test</b>	<b>IEC 60601-1-2:2014 home healthcare test level</b>	<b>Compliance level</b>	<b>Compliance</b>
Electrostatic discharge (ESD) IEC 61000-4-2	± 8 kV contact ± 2, 4, 8, 15 air	± 8 kV contact ± 2, 4, 8, 15 air	Compliant
Electrical fast transient/burst IEC 61000-4-4	± 2 kV, 100 kHz for power supply lines ± 1 kV, 100 kHz for input/output lines	± 2 kV, 100 kHz for power supply lines ± 1 kV, 100 kHz for input/output lines	Compliant
Surge IEC 61000-4-5	± 0.5 kv, ± 1 kv line(s) to line(s) ±0.5 kv, ±1 kv, ± 2 kV line(s) to earth	± 0.5 kv, ± 1 kv line(s) to line(s) ±0.5 kv, ±1 kv, ± 2 kV line(s) to earth	Compliant
Voltage dips, short interruptions, and voltage variations on power supply input lines IEC 61000-4-11	0% $U_T$ (100 % dip in $U_T$ ) for 0.5 cycle At 0°, 45°, 90°, 135°, 180°, 225°, 270°, and 315° 70 % $U_T$ (30 % dip in $U_T$ ) for 25/30 cycles 0% $U_T$ (100 % dip in $U_T$ ) for 250/300 cycle 0% $U_T$ (100 % dip in $U_T$ ) for 1 cycle	0% $U_T$ (100 % dip in $U_T$ ) for 0.5 cycle At 0°, 45°, 90°, 135°, 180°, 225°, 270°, and 315° 70 % $U_T$ (30 % dip in $U_T$ ) for 25/30 cycles 0% $U_T$ (100 % dip in $U_T$ ) for 250/300 cycle 0% $U_T$ (100 % dip in $U_T$ ) for 1 cycle 40 % $U_T$ (60 % dip in $U_T$ ) for 5 cycles	Compliant
Power frequency (50/60 Hz) magnetic field IEC 61000-4-8	30 A/m 50 Hz and 60 Hz	30 A/m 50 Hz and 60 Hz	Compliant

**NOTE:**  $U_T$  is the AC mains voltage prior to application of the test level.

<b>Guidance and manufacturer's declaration—electromagnetic immunity</b>			
The HP ElitePad 1000 G2 Healthcare Tablet is intended for use in the electromagnetic environment specified below. The customer or the user of the HP ElitePad 1000 G2 Healthcare Tablet should assure that it is used in such an environment.			
<b>Immunity test</b>	<b>IEC 60601-1-2:2014 home healthcare test level</b>	<b>Compliance level</b>	<b>Electromagnetic environment—guidance</b>
Conducted RF IEC 61000-4-6	Applies to both power supply lines and input/output lines: 3 V 0.15–80 MHz 6 V in ISM and amateur radio bands <sup>a</sup> between 0.15–80 MHz 80% AM at 1 kHz	Applies to both power supply lines and input/output lines: 3 V 0.15–80 MHz 6 V in ISM and amateur radio bands <sup>a</sup> between 0.15–80 MHz 80% AM at 1 kHz	Compliant
Radiated RF EM Fields IEC 61000-4-3	10 V/m 80 MHz–2.7 GHz 80% AM at 1 kHz	10 V/m 80 MHz–2.7 GHz 80% AM at 1 kHz	Compliant

**Guidance and manufacturer's declaration—electromagnetic immunity**

Proximity fields from RF wireless communication equipment	See <a href="#">Table 12-3 Proximity fields from RF wireless communication equipment on page 68.</a>	See <a href="#">Table 12-3 Proximity fields from RF wireless communication equipment on page 68.</a>	Compliant
---	--	--	-----------

<sup>a</sup> The ISM (industrial, scientific and medical) bands between 0,15 MHz and 80 MHz are 6,765 MHz to 6,795 MHz; 13,553 MHz to 13,567 MHz; 26,957 MHz to 27,283 MHz; and 40,66 MHz to 40,70 MHz. The amateur radio bands between 0,15 MHz and 80 MHz are 1,8 MHz to 2,0 MHz, 3,5 MHz to 4,0 MHz, 5,3 MHz to 5,4 MHz, 7 MHz to 7,3 MHz, 10,1 MHz to 10,15 MHz, 14 MHz to 14,2 MHz, 18,07 MHz to 18,17 MHz, 21,0 MHz to 21,4 MHz, 24,89 MHz to 24,99 MHz, 28,0 MHz to 29,7 MHz and 50,0 MHz to 54,0 MHz.

**Table 12-3 Proximity fields from RF wireless communication equipment**

Test frequency (MHz)	Band (MHz)	Service	Voltage level (V/m)	Modulation	Compliance
385	380–390	TETRA 400	27	50% PM, 18 Hz	Compliant
450	430–470	GMRS 460, FRS 460	28	FM ± 5 kHz deviation, 1 kHz sine	Compliant
710	704–787	LTE Band 13, 17	9	50% PM, 217 Hz	Compliant
745					Compliant
780					Compliant
810	800–960	GSM 800/900, TETRA 800, IDEN 820, CDMA 850, LTE Band 5	28	50% PM, 18 Hz	Compliant
870					Compliant
930					Compliant
1720	1700–1990	GSM 1800, CDMA 1900, GSM 1900, DECT, LTE Band 1, 3, 4, 25, UMTS	28	50% PM, 217 Hz	Compliant
1845					Compliant
1970					Compliant
2450	2400–2570	Bluetooth, WLAN, 802.11 b/g/n, RFID 2450, LTE Band 7	28	50% PM, 217 Hz	Compliant
5240	5100–5800	WLAN 802.11 a/n	9	50% PM, 217 Hz	Compliant
5500					Compliant
5785					Compliant

## Radiofrequency bandwidths

Receiver technology	Frequency or frequency band of reception	Bandwidth
Bluetooth 4.0	2.4 GHz	2 MHz
Wifi 802.11 a/b/g/n	2.4 GHz and 5.0 GHz	20/40 MHz
NFC ISO18092, ISO14443A/B	13.553–13.567 MHz	14 kHz
LTE cat3	1900 MHz, 2100 MHz, 850 MHz, 2600 MHz, 1800 MHz, 900 MHz, 800 MHz  LTE bands 1, 2, 3, 5, 7, 8, 20	20 MHz

## Radiofrequency transmitter bands and ERP

Transmitter technology	Frequency or frequency band	ERP (Effective Radiated Power)	E.I.R.P.
Bluetooth 4.0	2.4 GHz	8.04 dBm	10.19 dBm
Wifi 802.11 a/b/g/n	2.4 GHz and 5.0 GHz	2.4 GHz: 17.39 dBm	2.4 GHz: 19.54 dBm
		5 GHz: 19.7 dBm	5 GHz: 21.85 dBm
NFC ISO18092, ISO14443A/B	13.5 MHz	-43 dBm	-40.85 dBm
LTE cat3	2100 MHz, 1900 MHz, 1800 MHz, 1700 MHz, 850 MHz, 2500 MHz, 900 MHz, 800 MHz	B1: 25.19 dBm	B1: 27.34 dBm
		B2: 26.02 dBm	B2: 28.17 dBm
		B3: 24.17 dBm	B3: 26.32 dBm
		B5: 22.87 dBm	B5: 25.02 dBm
		B7: 21.63 dBm	B7: 23.78 dBm
		B8: 21.75 dBm	B8: 23.9 dBm
		B20: 22.87 dBm	B20: 25.02 dBm

---

# A Traveling with the tablet

For best results, follow these traveling and shipping tips:

- Prepare the tablet for traveling or shipping:

- Back up your information.
- Remove all external media cards, such as smart cards.

---

 **CAUTION:** To reduce the risk of damage to the tablet, damage to a drive, or loss of information, remove the media from a drive before shipping, storing, or traveling with a drive.

---

- Turn off and then disconnect all external devices.
  - Shut down the tablet.
- Take along a backup of your information. Keep the backup separate from the tablet.
  - When traveling by air, carry the tablet as hand luggage; do not check it in with the rest of your bags.

---

 **CAUTION:** Avoid exposing a drive to magnetic fields. Security devices with magnetic fields include airport walk-through devices and security wands. Airport conveyer belts and similar security devices that check carry-on baggage use X-rays instead of magnetism and do not damage drives.

---

- In-flight tablet use is at the discretion of the airline. If you plan to use the tablet during a flight, check with the airline in advance.
- If you are shipping the tablet, use suitable protective packaging and label the package “FRAGILE.”
- If the tablet has a wireless device installed, such as an 802.11 b/g device, a Global System for Mobile Communications (GSM) device, or a General Packet Radio Service (GPRS) device, the use of these devices may be restricted in some environments. Such restrictions may apply onboard aircraft, in hospitals, near explosives, and in hazardous locations. If you are uncertain of the policy that applies to the use of a particular device, ask for authorization to use it before you turn it on.
- If you are traveling internationally, follow these suggestions:
  - Check the tablet-related customs regulations for each country or region on your itinerary.
  - Check the power cord and adapter requirements for each location in which you plan to use the tablet. Voltage, frequency, and plug configurations vary.

---

 **WARNING!** To reduce the risk of electric shock, fire, or damage to the equipment, do not attempt to power the tablet with a voltage converter kit sold for appliances.

---

---

# B Troubleshooting

## Troubleshooting resources

- Access website links and additional information about the tablet through HP Support Assistant. To access HP Support Assistant, from the Start screen, select the **HP Support Assistant** app.

---

 **NOTE:** Some checkup and repair tools require an Internet connection. HP also provides additional tools that do not require an Internet connection.

---

- Contact HP support. For U.S. support, go to <http://www.hp.com/go/contactHP>. For worldwide support, go to [http://welcome.hp.com/country/us/en/wwcontact\\_us.html](http://welcome.hp.com/country/us/en/wwcontact_us.html).

Choose from the following types of support:

- Chat online with an HP technician.

---

 **NOTE:** When chat is not available in a particular language, it is available in English.

---

- Send an email to HP support.
- Find HP support worldwide telephone numbers.
- Locate an HP service center.

## Resolving issues

The following sections describe several common issues and solutions.

### The tablet is unable to start up

If the tablet does not turn on when you press the power button, the following suggestions may help you determine why the tablet does not start up:

- If the tablet is plugged into an AC outlet, unplug the tablet and plug another electrical device into the outlet to be sure that the outlet is providing adequate power.

---

 **NOTE:** Use only the AC adapter provided with the tablet or one approved by HP for this tablet.

---

- If the tablet is plugged into an external power source other than an AC outlet, plug the tablet into an AC outlet using the AC adapter. Be sure that the power cord and AC adapter connections are secure.

### An external device is not working

Follow these suggestions if an external device does not function as expected:

- Turn on the device according to the manufacturer's instructions.
- Be sure that all device connections are secure.
- Be sure that the device is receiving electrical power.
- Be sure that the device, especially if it is older, is compatible with the operating system.
- Be sure that the correct drivers are installed and updated.

## A video is not visible on an external display

1. If both the tablet and an external display device are on, use the on-screen keyboard to press **fn+f4** one or more times to switch between the tablet screen and the external display.
2. Configure the monitor settings to make the external display primary:
  - a. From the Windows desktop, right-click on a blank area of the screen, and select **Screen resolution**.
  - b. Specify a primary display and a secondary display.



**NOTE:** When using both displays, a DVD image will not appear on any display designated as the secondary display.

---



# Index

## A

- administrator password 47
- ambient light sensor, identifying 4
- antivirus software 47
- audio functions, checking 28
- audio-out (headphone)/audio-in (microphone) jack, identifying 7

## B

- bar-code scanner
  - configuring 31, 32
  - default settings 33
  - identifying 8
  - scanning 31
- battery
  - conserving power 39
  - discharging 37
  - displaying remaining charge 37
  - low battery levels 37
- Battery Check 37
- battery information, finding 37
- battery power 36

## BIOS

- determining version 56
- updating 56

Bluetooth device 12, 15

Bluetooth label 8

bottom 8

## buttons

- bar-code scanner 6
- power 7, 35
- volume 28

## C

- cable, USB 41
- caring for your tablet 50
- checking audio functions 28
- cleaning your tablet 50
- components
  - back 6
  - bottom 8
  - front 4
  - top 7
- configuring
  - audio for HDMI 30

- connecting to a WLAN 14
- connector, power 8
- conservation, power 39
- corporate WLAN connection 14
- critical battery level 35
- critical updates, software 48

## D

- docking connector, identifying 8
- drive media 35
- drives
  - external 44
  - hard 44
  - optical 44

## E

- edge-swipe gestures 24, 25
- external AC power, using 39
- external devices 44
- external drive 44

## F

- f11 recovery 53
- firewall software 47

## G

GPS 15

## H

- hard drive recovery 53
- hard drive, external 44
- HDMI port
  - connecting 30
  - identifying 8
- HDMI, configuring audio 30
- headphones and microphones, connecting 28
- high-definition devices, connecting 30
- HP Client Security 48
- HP Mobile Broadband, disabled 16
- HP PC Hardware Diagnostics (UEFI) 57
- hubs 41

## I

- input power 59
- integrated webcam light, identifying 6
- internal microphones, identifying 7
- Internet connection setup 13
- issues, resolving 71

## J

- Java Card
  - defined 40
  - inserting 40
  - removing 41

## L

- labels
  - Bluetooth 8
  - Microsoft Certificate of Authenticity 8
  - regulatory 8
  - serial number 8
  - service 8
  - wireless certification 8
  - WLAN 8
- left-edge swipe 25
- lights, webcam 6
- low battery level 37

## M

- micro SIM, inserting 16
- microSD card, inserting 16

## N

- Near Field Communications 34
- NFC tapping area 5

## O

- operating environment 59
- optical drive 44
- optional external devices, using 44

## P

- password protection on wakeup 36

- passwords
  - administrator 47
  - user 47
- pinching touch screen gesture 23
- ports
  - HDMI 8, 30
- power
  - battery 36
  - conserving 39
  - options 35
- power button 35
- power button, identifying 7
- power connector, identifying 8
- power-saving states 35
- product name and number,
  - computer 8
- public WLAN connection 14
  
- R**
- readable media 35
- recovery 54
- recovery partition 53
- refresh 54
- regulatory information
  - regulatory label 8
  - wireless certification labels 8
- restoring the hard drive 53
- right-edge swipe 24
  
- S**
- security cable slot, identifying 6
- security, wireless 13
- serial number 8
- serial number, computer 8
- service labels, locating 8
- setting
  - password protection on wakeup 36
  - power options 35
- setup of WLAN 13
- shutdown 35
- Sleep
  - exiting 35
  - initiating 35
- slot, security cable 6
- smart card
  - defined 40
  - inserting 40
  - removing 41
- smart card reader 6

- SoftPaqs, downloading 51
- software
  - antivirus 47
  - critical updates 48
  - firewall 47
- speakers, identifying 8
  
- T**
- tablet, traveling 70
- top-edge swipe 25
- touch screen gestures 24, 25
  - 2-finger click 23
  - edge-swipe gestures 24, 25
  - one-finger slide 21
  - pinch 23
  - rotating 24
  - scrolling 22
  - tapping 22
- touch screen, using 21
- traveling with the computer 8
- traveling with the tablet 70
- troubleshooting, external display 72
- turning off the tablet 35
  
- U**
- unresponsive system 35
- USB 3.0 port 8
- USB cable, connecting 41
- USB devices
  - connecting 41
  - description 41
  - removing 41
- USB hubs 41
- USB ports, identifying 8
- user password 47
- using
  - external AC power 39
  - power-saving states 35
  
- V**
- video 29
- volume
  - adjusting 28
  - buttons 28
  
- W**
- webcam 4
  - identifying 6
  - using 29
- webcam light, identifying 6

- Windows
  - Refresh 54
- Windows button, identifying 5
- wireless antennas, identifying 4
- wireless certification label 8
- wireless controls, operating system 12
- wireless network (WLAN)
  - connecting 14
  - corporate WLAN connection 14
  - equipment needed 13
  - functional range 14
  - public WLAN connection 14
  - security 13
  - using 12
- WLAN
  - antennas, identifying 4
  - device 12
- WLAN device 8
- WLAN label 8
- writable media 35
- WWAN
  - antennas, identifying 4
  - device 15
  
- Z**
- zoom touch screen gesture 23

## Free Manuals Download Website

<http://myh66.com>

<http://usermanuals.us>

<http://www.somanuals.com>

<http://www.4manuals.cc>

<http://www.manual-lib.com>

<http://www.404manual.com>

<http://www.luxmanual.com>

<http://aubethermostatmanual.com>

Golf course search by state

<http://golfingnear.com>

Email search by domain

<http://emailbydomain.com>

Auto manuals search

<http://auto.somanuals.com>

TV manuals search

<http://tv.somanuals.com>