



HP EliteBook 820 G3 Notebook PC

Maintenance and Service Guide

© Copyright 2015 HP Development Company, L.P.

AMD is a trademark of Advanced Micro Devices, Inc. Bluetooth is a trademark owned by its proprietor and used by HP Inc. under license. Intel is a trademark of Intel Corporation in the U.S. and other countries. Linux® is the registered trademark of Linus Torvalds in the U.S. and other countries. Microsoft and Windows are either registered trademarks or trademarks of Microsoft Corporation in the United States and/or other countries. Qualcomm is a trademark of Qualcomm Incorporated, registered in the United States and other countries, used with permission.

For DTS patents, see <http://patents.dts.com>. Manufactured under license from DTS Licensing Limited. DTS, the Symbol, & DTS and the Symbol together are registered trademarks, and DTS Studio Sound is a trademark of DTS, Inc. © DTS, Inc. All Rights

Reserved  .

Product notice

This guide describes features that are common to most models. Some features may not be available on your computer.

Not all features are available in all editions of Windows 10 or Windows 8. This computer may require upgraded and/or separately purchased hardware, drivers and/or software to take full advantage of Windows 10 or Windows 8 functionality. See <http://www.microsoft.com> for details.

The information contained herein is subject to change without notice. The only warranties for HP products and services are set forth in the express warranty statements accompanying such products and services. Nothing herein should be construed as constituting an additional warranty. HP shall not be liable for technical or editorial errors or omissions contained herein.

First Edition: October 2015

Document Part Number: 843203-001

Important Notice about Customer Self-Repair Parts

 **CAUTION:** Your computer includes Customer Self-Repair parts and parts that should only be accessed by an authorized service provider. See Chapter 5, "Removal and replacement procedures for Customer Self-Repair parts," for details. Accessing parts described in Chapter 6, "Removal and replacement procedures for Authorized Service Provider only parts," can damage the computer or void your warranty.

Safety warning notice

 **WARNING!** To reduce the possibility of heat-related injuries or of overheating the device, do not place the device directly on your lap or obstruct the device air vents. Use the device only on a hard, flat surface. Do not allow another hard surface, such as an adjoining optional printer, or a soft surface, such as pillows or rugs or clothing, to block airflow. Also, do not allow the AC adapter to contact the skin or a soft surface, such as pillows or rugs or clothing, during operation. The device and the AC adapter comply with the user-accessible surface temperature limits defined by the International Standard for Safety of Information Technology Equipment (IEC 60950-1).

Table of contents

1 Product description	1
2 External component identification	6
Right	6
Left	8
Display	9
Top	10
TouchPad	10
Lights	11
Buttons, speakers, and fingerprint reader	12
Keys	13
Using the hot keys	13
Bottom	15
Front	15
Locating system information	16
3 Illustrated parts catalog	18
Computer major components	18
Display assembly subcomponents	21
Plastics kit	22
Cable kit	23
Mass storage devices	24
Miscellaneous parts	25
4 Removal and replacement procedures preliminary requirements	27
Tools required	27
Service considerations	27
Plastic parts	27
Cables and connectors	28
Drive handling	28
Grounding guidelines	29
Electrostatic discharge damage	29
Packaging and transporting guidelines	30
Workstation guidelines	30
Equipment guidelines	31

5 Removal and replacement procedures for Customer Self-Repair parts	32
Component replacement procedures	32
Bottom cover	32
Battery	35
Hard drive	36
SSD	38
Memory modules	40
WLAN/Bluetooth combo card	42
WWAN module	44
Keyboard	46
6 Removal and replacement procedures for Authorized Service Provider parts	49
Component replacement procedures	49
System board	49
RTC battery	52
Heat sink/fan assembly	53
Fingerprint reader assembly	55
Touchpad button board	56
NFC module	57
Smart card reader board	58
Speaker assembly	59
Display assembly	61
Top cover	65
7 Computer Setup (BIOS), TPM, and HP Sure Start in Windows 10	67
Using Computer Setup	67
Starting Computer Setup	67
Navigating and selecting in Computer Setup	67
Restoring factory settings in Computer Setup	68
Updating the BIOS	69
Determining the BIOS version	69
Downloading a BIOS update	69
Changing the boot order using the f9 prompt	70
TPM BIOS settings (select products only)	70
Using HP Sure Start (select products only)	71
8 Computer Setup (BIOS), TPM, and HP Sure Start in Windows 8	72
Using Computer Setup	72
Starting Computer Setup	72
Navigating and selecting in Computer Setup	72

Restoring factory settings in Computer Setup	73
Updating the BIOS	74
Determining the BIOS version	74
Downloading a BIOS update	74
Changing the boot order using the f9 prompt	75
TPM BIOS settings (select products only)	75
Using HP Sure Start (select products only)	76
9 Computer Setup (BIOS), TPM, and HP Sure Start in Windows 7	77
Using Computer Setup	77
Starting Computer Setup	77
Navigating and selecting in Computer Setup	77
Restoring factory settings in Computer Setup	78
Updating the BIOS	79
Determining the BIOS version	79
Downloading a BIOS update	79
Changing the boot order using the f9 prompt	80
TPM BIOS settings (select products only)	80
Using HP Sure Start (select products only)	81
10 HP PC Hardware Diagnostics (UEFI)	82
Downloading HP PC Hardware Diagnostics (UEFI) to a USB device	82
11 Backing up and recovering Windows 10	84
Creating recovery media and backups	84
Creating HP Recovery media (select products only)	84
Using Windows tools	85
Restore and recovery	86
Recovering using HP Recovery Manager	86
What you need to know before you get started	86
Using the HP Recovery partition (select products only)	87
Using HP Recovery media to recover	87
Changing the computer boot order	88
Removing the HP Recovery partition (select products only)	89
12 Backing up and recovering Windows 8	90
Backing up your information	90
Performing a system recovery	90
Using the Windows recovery tools	90
Using f11 recovery tools	91

Using Windows operating system media (purchased separately)	92
Using Windows Refresh or Windows Reset	93
Using HP Software Setup	93
13 Backing up and recovering Windows 7	94
Creating recovery media and backups	94
Guidelines	94
Creating recovery media with HP Recovery Disc Creator	94
Creating recovery media	95
Backing up your information	95
Performing a system recovery	96
Using the Windows recovery tools	96
Using f11 recovery tools (select models only)	97
Using Windows 7 operating system media	97
14 Specifications	99
Input power	99
Operating environment	99
15 Power cord set requirements	100
Requirements for all countries	100
Requirements for specific countries and regions	100
16 Statement of memory volatility	102
Nonvolatile memory usage	104
Questions and answers	106
Using HP Sure Start (select models only)	107
17 Recycling	108
Index	109

1 Product description

Category	Description
Product Name	HP EliteBook 820 G3 Notebook PC
Processors	<p>Processors are attached to the system board.</p> <p>Sixth-generation Intel® Core™ processors:</p> <ul style="list-style-type: none">• Intel Core™ i7-6600U• Intel Core i7-6500U• Intel Core i5-6300U• Intel Core i5-6200U• Intel Core i3-6100U
Chipset	<p>Integrated with processor</p> <p>Intel Skylake Premium, for use with 6th generation Intel Core processors</p> <p>Intel UMA graphics (with shared video memory)</p> <p>Up to three independent displays supported with docking solution</p> <ul style="list-style-type: none">• Intel HD Graphics 520
Panel	<p>12.5 in (31.75 cm), high-definition (HD), Slim eDP (1366×768), SVA AG, typical brightness: 220 cd/m2 (nits) with and without webcam</p> <p>12.5 in (31.75 cm), full high-definition (FHD), UltraSlim eDP (1920×1080), UWVA AG, typical brightness: 300 cd/m2 (nits) with and without webcam</p> <p>12.5 in (31.75 cm), full high-definition (FHD), UltraSlim eDP (1920×1080) UWVA AG, typical brightness: 300 cd/m2 (nits) with touch and webcam</p>
Memory	<p>Two SODIMM customer-accessible/upgradable memory module slots</p> <p>Supports up to 16 GB of system RAM</p> <p>DDR4 PC4-17000 (2133 MHz) dual channel support</p> <p>Supports the following configurations:</p> <ul style="list-style-type: none">• 16384 MB (8192 MB×2; not supported on computer models with a Windows® 7 32-bit operating system)• 12288 (8192 MB + 4096 MB; not supported on computer models with a Windows 7 32-bit operating system)• 8192 MB (8192 MB×1 or 4096 MB×2; not supported on computer models with a Windows 7 32-bit operating system)• 4096 MB (4096 MB×1)
Hard drive	<p>HDDs:</p> <p>Supports 6.35 cm (2.5 in) hard drives in 7.0 mm (.28 in) thicknesses (all hard drives use the same bracket)</p> <p>Serial ATA</p> <ul style="list-style-type: none">• 1 TB, 5400 rpm, 7.0 mm• 500 GB, 7200 rpm, 7.0 mm, self-encrypting (FIPS-140-2; Opal 2)

Category	Description
	<ul style="list-style-type: none"> • 500 GB, 7200 rpm, 7.0 mm, self-encrypting (Opal 2) • 500 GB, 7200 rpm, 7.0 mm • 500 GB, 7.0 mm, hybrid, 8 GB cach <p>SSDs:</p> <ul style="list-style-type: none"> • M.2 (2280) 512 GB SATA-3 TLC • M.2 (2280) 256 GB PCIe-3×4 SS NVMe • M.2 (2280) 256 GB SATA-3 self-encrypting (Opal 2) MLC • M.2 (2280) 256 GB SATA-3 TLC • M.2 (2280) 240 GB SATA-3 MLC DS • M.2 (2280) 180 GB SATA-3 self-encrypting (Opal 2) MLC • M.2 (2280) 180 GB SATA-3 MLC • M.2 (2280) 128 GB SATA-3 TLC
Audio and video	<p>Supports:</p> <p>DTS Studio Sound</p> <p>Conexant smart amplifier and ambient noise suppression</p> <p>Dual-array microphone</p> <p>Dual speakers</p> <p>Webcamera (720p)</p> <ul style="list-style-type: none"> • Intel WGI219V 10/100/1000 Ethernet, non-vPro, for use with computer models with i7-6500U, i5-6200U, or i3-6100U processors • Intel WGI219LM 10/100/1000 Ethernet, iAMT, for use with computer models with i7-6600U or i5-6300U processors <p>S3/S4/S5 Wake-on-LAN</p>
Wireless	<p>WLAN</p> <p>Integrated wireless local area network (WLAN) options by way of wireless module</p> <p>Two WLAN antennas built into display assembly</p> <p>Integrated wireless personal area network (PAN) supported by Bluetooth® 4.0 or Bluetooth 4.2 combo card</p> <p>Compatible with Miracast-certified devices</p> <p>Support for the following WWAN formats:</p> <ul style="list-style-type: none"> • Intel Dual Band Wireless-AC 8260NGW 802.11a/b/g/n+ac 2x2 Wi-Fi + BT 4.2 combo adapter (i7-6600U, i5-6300U) • Intel Dual Band Wireless-AC 8260NGW 802.11a/b/g/n+ac non-vPro 2x2 Wi-Fi + BT 4.2 combo adapter (i7-6500U, i5-6200U, i3-6100U) • Intel Dual Band Wireless-AC 3165 802.11a/b/g/n+ac 1x1 Wi-Fi + BT 4.0 combo adapter (i7-6500U, i5-6200U, i3-6100U) <p>Supports no WLAN option</p> <hr/> <p>NFC</p> <p>Supports the following NFC formats:</p> <p>Integrated NFC Galapagos NXP NPC100 12C NCI 10 mm x 25 mm module</p>

Category	Description
	<p>NFC antenna</p> <p>Supports no NFC option</p> <hr/> <p>WWAN</p> <p>Integrated wireless wide area network (WWAN) options by way of wireless module</p> <p>Two WWAN antennas built into display assembly</p> <p>Supports the following WWAN formats:</p> <ul style="list-style-type: none"> • HP It4120 Qualcomm® Snapdragon™ X5 LTE Mobile Broadband Module • HP hs31110 HSPA + Intel Mobile Broadband Module <p>Supports no WWAN option</p> <hr/>
External media cards	<p>SIM card reader</p> <p>Memory card reader (SD, SDHC, SDXC)</p> <hr/>
Ports	<p>VGA</p> <p>USB 3.0 charging</p> <p>USB 3.0</p> <p>USB Type-C</p> <p>DisplayPort</p> <p>RJ-45</p> <p>Docking connector</p> <p>Audio-out (headphone)/audio-in (microphone) combo jack</p> <p>AC port</p> <hr/>
Keyboard/pointing devices	<p>Keyboard:</p> <p>Dura keys, backlit, spill resistant with drain</p> <p>Spill resistant with drain</p> <p>TouchPad:</p> <p>Gestures enabled by default: two-finger scrolling, two-finger pinch-zoom</p> <p>Taps enabled by default</p> <p>On/off button</p> <p>Glass</p> <hr/>
Power requirements	<p>3-cell Li-Ion battery, 44 WHr, 3.91 Ahr</p> <p>65 W HP Smart AC adapter</p> <p>45 W HP Smart AC adapter</p> <p>45 W, 2-prong AC adapter</p> <hr/>
Security	<p>Security lock</p> <p>Fingerprint reader</p> <p>Supports Trusted Platform Module (TPM) 1.2 or 2.0 (Infineon, soldered down)</p> <p>Integrated Smart Card reader (active)</p> <p>Preboot authentication (password, smart card)</p> <hr/>





Category	Description
Operating system	Preinstalled: <ul style="list-style-type: none"> • Windows 7 Professional 32-bit and 64-bit • Windows 8.1 China 64 (CPPP) • Windows 8.1 High-end Emerging Markets 64 • Windows 8.1 Emerging Markets 64 • Windows 8.1 High-end Multilingual 64 • Windows 8.1 Multilingual 64 • Windows 8.1 Professional 64 • Windows 8.1 Core for Higher Education (Emerging Markets) • Windows 10 Home 64 • Windows 10 Home 64 Single Language • Windows 10 Home 64 Chinese Market (CPPP) • Windows 10 Home High-End • Windows 10 Home High-End Single Language • Windows 10 Professional 64 • Windows 10 Professional 64 with downgrade to Windows 7 32- or 64-bit • Windows 10 Professional 64 Chinese Market • Windows 10 Professional 64 with downgrade to Windows 7 32- or 64-bit Chinese Market • NeoKylin Linux 64-bit • FreeDOS 2.0
	Restore Media—DR/SR-DVD <ul style="list-style-type: none"> • Windows 7 • Windows 8.1 • Windows 10 • NeoKylin Linux
	Restore Media—OSDVD: <ul style="list-style-type: none"> • Windows 7 Professional 32- or 64-bit • Windows 8.1 Professional 64-bit • Windows 8.1 64-bit • Windows 8.1 Country Specific 64-bit • Windows 8.1 Emerging Markets 64-bit • Windows 10 Professional 64
	Certified: <ul style="list-style-type: none"> • Microsoft WHQL
	Web-only support: <ul style="list-style-type: none"> • Windows 7 Enterprise 32 • Windows 7 Enterprise 64

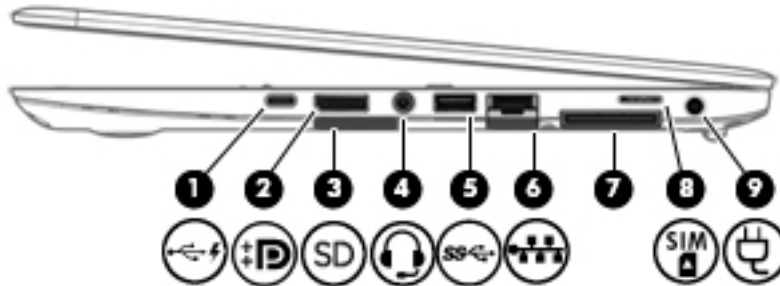

Category	Description
	<ul style="list-style-type: none">• Windows 8.1 Enterprise 64• Windows 10 Professional 64
Serviceability	End user replaceable parts: AC adapter Battery Hard drive SSD Memory module WLAN WWAN Keyboard

2 External component identification

Right





Component	Description
(1)  USB Type-C (charging) port	Connects any USB device with a Type-C connector. NOTE: USB Type-C ports charge products such as cell phones, laptops, tablets, and MP3 players, even when the computer is off. Also, some USB Type-C ports connect DisplayPort, VGA, HDMI and other video devices to provide video output. NOTE: Adapters (purchased separately) may be required.
(2)  Dual-Mode DisplayPort	Connects an optional digital display device, such as a high-performance monitor or projector.
(3)  Memory card reader	Reads optional memory cards that store, manage, share, or access information.
(4)  Audio-out (headphone)/Audio-in (microphone) combo jack	Connects optional powered stereo speakers, headphones, earbuds, a headset, or a television audio cable. Also connects an optional headset microphone. This jack does not support optional microphone-only devices. WARNING! To reduce the risk of personal injury, adjust the volume before putting on headphones, earbuds, or a headset. For additional safety information, refer to the <i>Regulatory, Safety, and Environmental Notices</i> . To access this guide: Windows 10: Select the Start button, select All apps , select HP Help and Support , and then select HP Documentation . Windows 8 or Windows 7: Select the HP Support Assistant app on the Start screen, select My computer , and then select User guides . NOTE: When a device is connected to the jack, the computer speakers are disabled.
(5)  USB 3.0 port	Connects an optional USB device, such as a keyboard, mouse, external drive, printer, scanner or USB hub.

Component	Description
(6)  RJ-45 (network) jack/status lights	Connects a network cable. <ul style="list-style-type: none">• Green (left): The network is connected.• Amber (right): Activity is occurring on the network.
(7) Docking connector	Connects an optional docking device.
(8)  SIM card slot	Supports a wireless subscriber identity module (SIM) card.
(9)  Power connector	Connects an AC adapter.

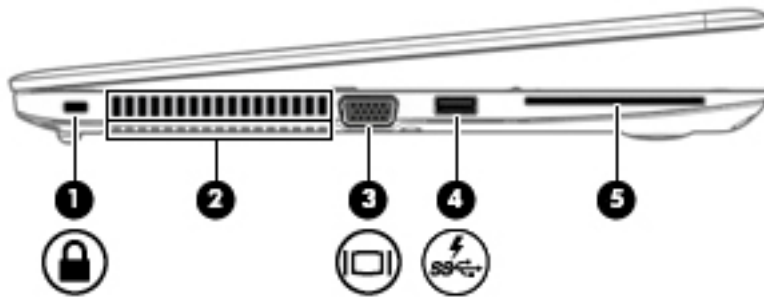
Left



Component	Description
(1)  Security cable slot	Attaches an optional security cable to the computer. NOTE: The security cable is designed to act as a deterrent, but it may not prevent the computer from being mishandled or stolen.
(2) Vents (2)	Enable airflow to cool internal components. NOTE: The computer fan starts up automatically to cool internal components and prevent overheating. It is normal for the internal fan to cycle on and off during routine operation.
(3)  External monitor port	Connects an external VGA monitor or projector.
(4)  USB 3.0 charging (powered) port	Connects an optional USB device, such as a keyboard, mouse, external drive, printer, scanner or USB hub. Standard USB ports will not charge all USB devices or will charge using a low current. Some USB devices require power and require you to use a powered port. NOTE: USB charging ports can also charge select models of cell phones and MP3 players, even when the computer is off.
(5) Smart card reader	Supports optional smart cards.

Display



Component	Description
(1) WLAN antennas*	Send and receive wireless signals to communicate with wireless local area networks (WLANs).
(2) WWAN antennas*	Send and receive wireless signals to communicate with wireless wide area networks (WWANs).
(3) Internal microphones	Record sound.
(4) Webcam light	On: The webcam is in use.
(5) Webcam	Records video and captures photographs. Some models allow you to video conference and chat online using streaming video. To use the webcam: <ul style="list-style-type: none">▲ Type <code>camera</code> in the taskbar search box, and then select Camera.

*The antennas are not visible from the outside of the computer. For optimal transmission, keep the areas immediately around the antennas free from obstructions.

For wireless regulatory notices, see the section of the *Regulatory, Safety, and Environmental Notices* that applies to your country or region.

To access this guide:

Windows 10:

Select the **Start** button, select **All apps**, select **HP Help and Support**, and then select **HP Documentation**.

Windows 8 or Windows 7:

Select the **HP Support Assistant** app on the Start screen, select **My computer**, and then select **User guides**.

Top



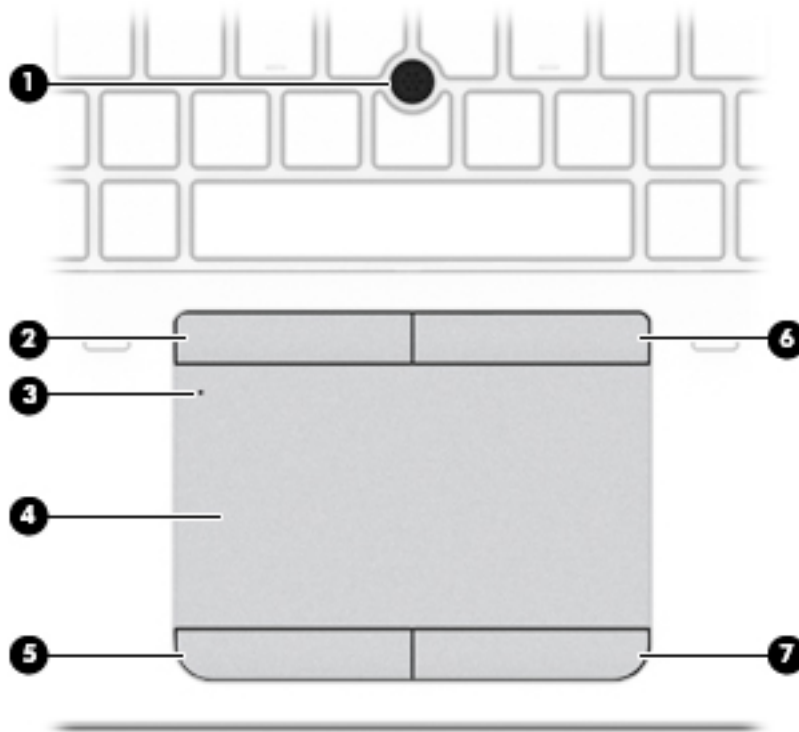

TouchPad

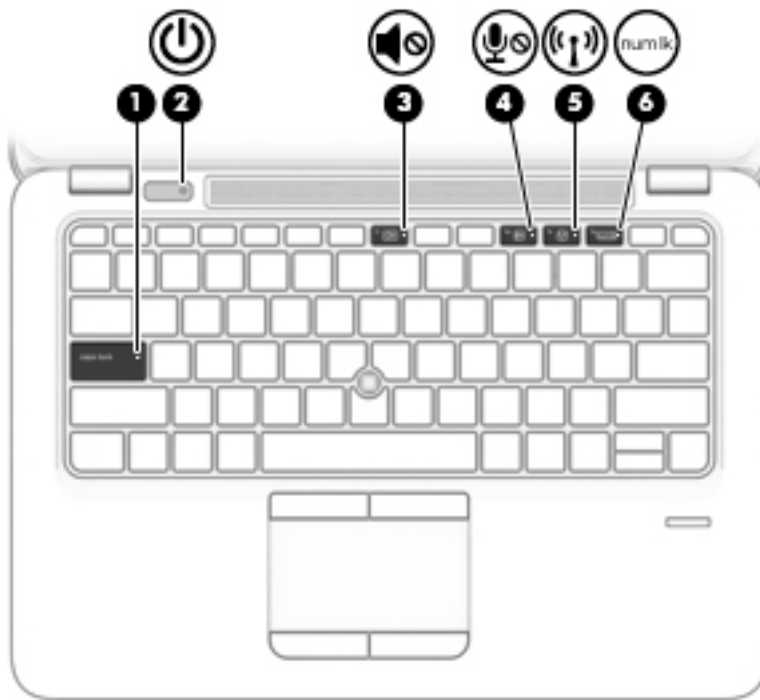

Component	Description
(1)	Pointing stick (select products only) Moves the pointer and selects or activates items on the screen.
(2)	Left pointing stick button (select products only) Functions like the left button on an external mouse.
(3)	TouchPad on/off button/TouchPad light Turns the TouchPad on and off. <ul style="list-style-type: none">• On: The TouchPad is off.• Off: The TouchPad is on.
(4)	TouchPad zone Reads your finger gestures to move the pointer or activate items on the screen.
(5)	Left TouchPad button Functions like the left button on an external mouse.
(6)	Right pointing stick button (select products only) Functions like the right button on an external mouse.
(7)	Right TouchPad button Functions like the right button on an external mouse.

Lights



Component	Description
(1) Caps lock light	On: Caps lock is on, which switches the key input to all capital letters.
(2)  Power light	<ul style="list-style-type: none"> On: The computer is on. Blinking: The computer is in the Sleep state, a power-saving state. The computer shuts off power to the display and other unneeded components. Off: The computer is off or in Hibernation. Hibernation is a power-saving state that uses the least amount of power.
(3)  Mute light	<ul style="list-style-type: none"> Amber: Computer sound is off. Off: Computer sound is on.
(4)  Microphone mute light	<ul style="list-style-type: none"> Amber: microphone sound is off. Off: microphone sound is on.
(5)  Wireless light	<p>On: An integrated wireless device, such as a wireless local area network (WLAN) device and/or a Bluetooth® device, is on.</p> <p>NOTE: On some models, the wireless light is amber when all wireless devices are off.</p>
(6)  Num lock light	On: Num lock is on.



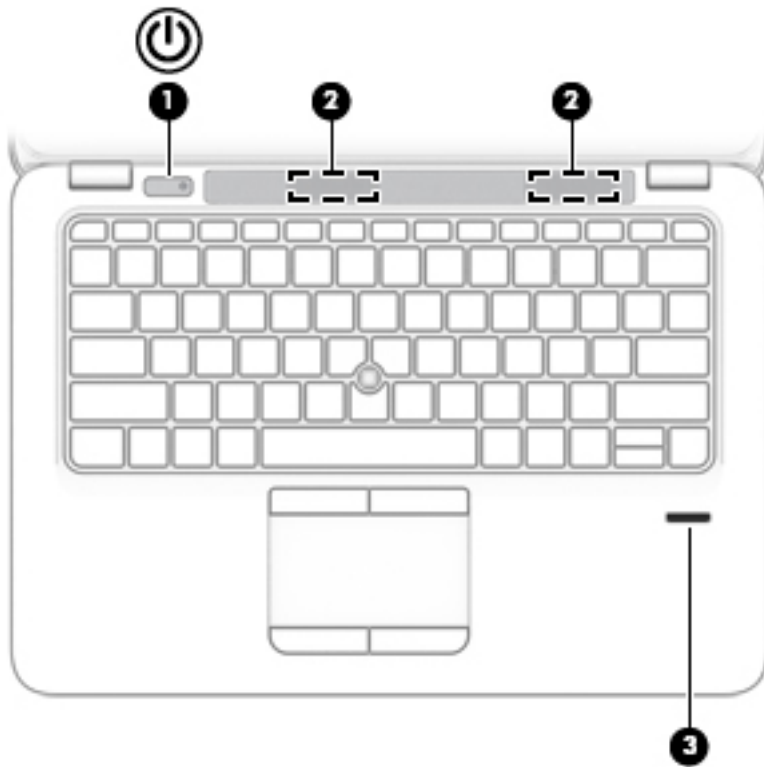

Buttons, speakers, and fingerprint reader

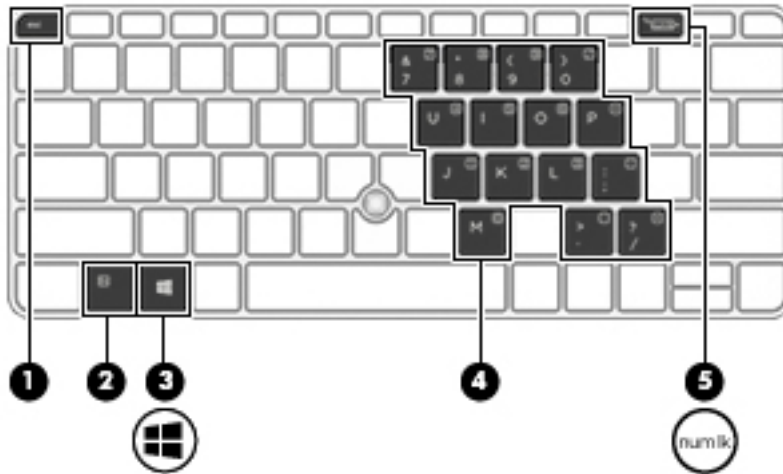

Component	Description
<p>(1)  Power button</p>	<ul style="list-style-type: none"> • When the computer is off, press the button to turn on the computer. • When the computer is on, press the button briefly to initiate Sleep. • When the computer is in the Sleep state, press the button briefly to exit Sleep. • When the computer is in Hibernation, press the button briefly to exit Hibernation. <p>CAUTION: Pressing and holding down the power button results in the loss of unsaved information.</p> <p>If the computer has stopped responding and shutdown procedures are ineffective, press and hold the power button for at least 15 seconds to turn off the computer.</p> <p>To learn more about your power settings, see your power options.</p> <p>▲ Type <code>power</code> in the taskbar search box, and then select Power and sleep settings.</p> <p>– or –</p> <p>Right-click the Start button, and then select Power Options.</p>
<p>(2) Speakers</p>	<p>Produce sound.</p>
<p>(3) Fingerprint reader (select products only)</p>	<p>Allows a fingerprint logon to Windows, instead of a password logon.</p>

Keys













Component	Description
(1)  esc key	Displays system information when pressed in combination with the fn key.
(2)  fn key	Executes frequently used system functions when pressed in combination with a function key, the num lock key, or the esc key. See Using the hot keys on page 13
(3)  Windows key	Opens the Start menu. NOTE: Pressing the Windows key again will close the Start menu.
(4) Embedded numeric keypad	A numeric keypad superimposed over the keyboard alphabet keys that enables you to add, subtract, and perform other numeric tasks. When num lock is on, the keypad can be used like an external numeric keypad.
(5)  num lk num lock key	Turns the embedded numeric keypad on and off.

Using the hot keys

To use a hot key:

- ▲ Press the **fn** key, and then press the correct function key represented by the icons below.

Press fn +function key	Description
	Initiates Sleep, which saves your information in system memory. The display and other system components turn off and power is conserved. To exit Sleep, briefly press the power button. CAUTION: To reduce the risk of information loss, save your work before initiating Sleep.
	Turns the backlight keyboard off or on. NOTE: To conserve battery power, turn off this feature.

Press fn +function key	Description
	<p>Switches the screen image among display devices connected to the system. For example, if a monitor is connected to the computer, repeatedly pressing fn+f4 alternates the screen image from computer display to monitor display to simultaneous display on both the computer and the monitor.</p> <p>Most external monitors receive video information on the computer using the external VGA video standard. The fn+f4 hot key can also alternate images among other devices that are receiving video information on the computer.</p>
	Decreases the screen brightness incrementally as long as you hold down the key.
	Increases the screen brightness incrementally as long as you hold down the key.
	Mutes or restores speaker sound.
	Decreases speaker volume incrementally while you hold down the key.
	Increases speaker volume incrementally while you hold down the key.
	Mutes the microphone.
	<p>Turns the wireless feature on or off.</p> <p>NOTE: A wireless network must be set up before a wireless connection is possible.</p>
R	Pauses or breaks an operation. This replaces the break key.
C	Locks cell. This replaces the scroll lock key.
S	Sends a programming query. This replaces the sys rq key.

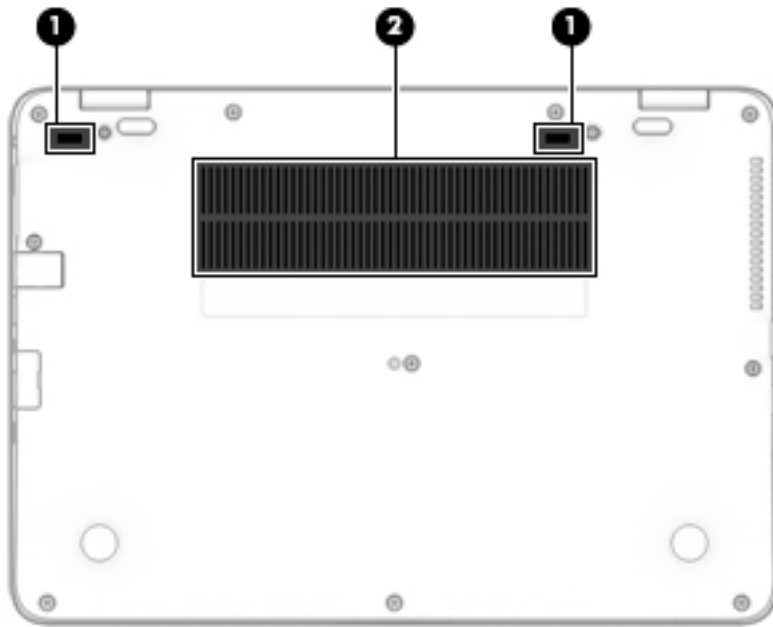

Bottom





Component		Description
(1)	Docking connector	Connects an optional docking device.
(2)	Vents (2)	Enable airflow to cool internal components. NOTE: The computer fan starts up automatically to cool internal components and prevent overheating. It is normal for the internal fan to cycle on and off during routine operation.

Front



Component		Description
(1)		Wireless light On: An integrated wireless device, such as a wireless local area network (WLAN) device and/or a Bluetooth® device, is on. NOTE: On some models, the wireless light is amber when all wireless devices are off.
(2)		Power light • On: The computer is on.

Component	Description
	<ul style="list-style-type: none"> Blinking: The computer is in the Sleep state, a power-saving state. The computer shuts off power to the display and other unneeded components. Off: The computer is off or in Hibernation. Hibernation is a power-saving state that uses the least amount of power.
(3)  Battery light	<p>When AC power is connected:</p> <ul style="list-style-type: none"> White: The battery charge is greater than 90 percent. Amber: The battery charge is from 0 to 90 percent. Off: The battery is not charging. <p>When AC power is disconnected (battery not charging):</p> <ul style="list-style-type: none"> Blinking amber: The battery has reached a low battery level. When the battery has reached a critical battery level, the battery light begins blinking rapidly. Off: The battery is not charging.
(4)  Drive light	<ul style="list-style-type: none"> Blinking white: The hard drive is being accessed. Amber: HP 3D DriveGuard has temporarily parked the hard drive.

Locating system information

Important system information is located on the bottom edge of the tablet or on the keyboard base. You may need the information when travelling internationally or when you contact support:

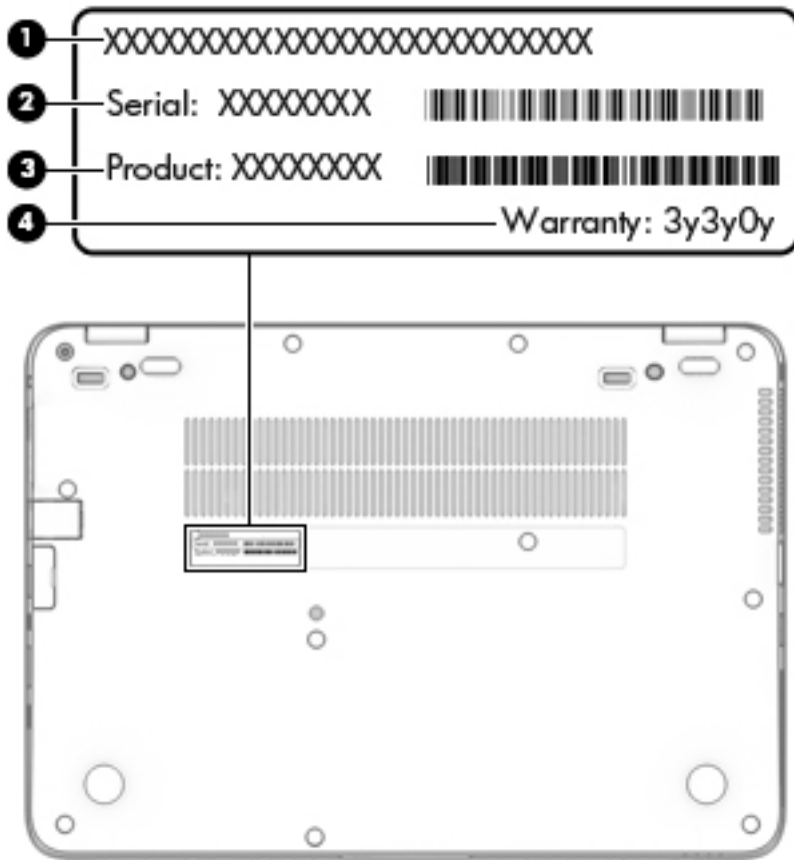

- (1):** Serial number
- (2):** Product number
- (3):** Model number
- (4):** Warranty period



Using Windows, briefly press the **fn+esc** key combination to display the System Information screen, which provides the product name and serial number of your computer, as well as information about the memory, processor, BIOS, and keyboard.

3 Illustrated parts catalog

Computer major components

-  **NOTE:** HP continually improves and changes product parts. For complete and current information on supported parts for your computer, go to <http://partsurfer.hp.com>, select your country or region, and then follow the on-screen instructions.
-  **NOTE:** Details about your computer, including model, serial number, product key, and length of warranty, are on the service tag at the bottom of your computer. See [Locating system information on page 16](#) for details.

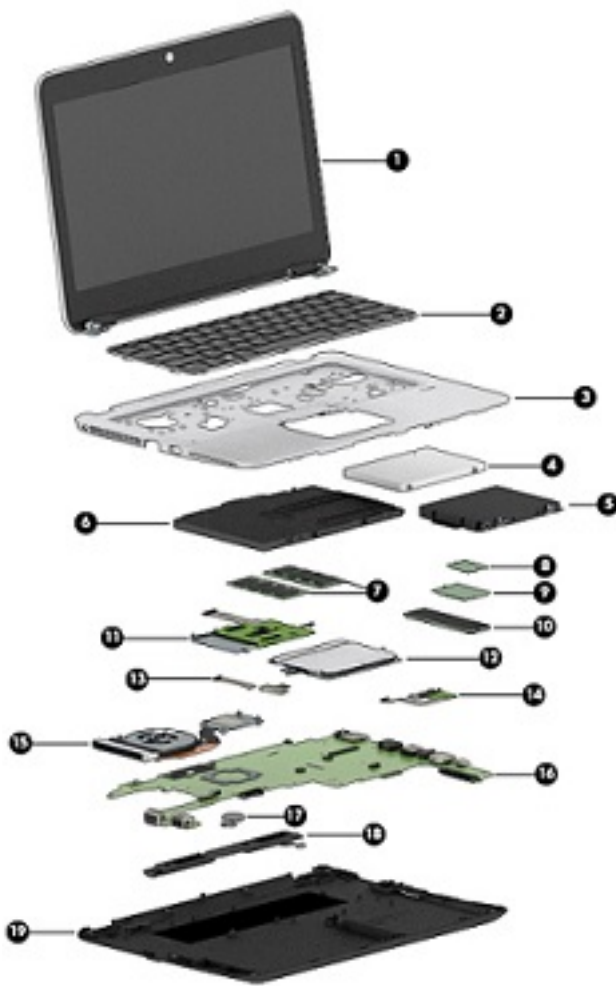

Item	Component	Spare part number
(1)	Display assembly: Display assembly: Non-touch display assemblies are spared at the subcomponent level only. For more non-touch display assembly spare part information, see Display assembly subcomponents on page 21 .	
(2)	Keyboard (see Keyboard on page 46)	
(3)	Top cover	821692-001

Item	Component	Spare part number
(4)	Hard drive hardware kit	821665-001
(5)	Hard drive (does not include hard drive connector cable or hard drive rubber bracket):	
	1 TB, 5400 rpm, 7 mm	762990-001
	500 GB, 7200 rpm, 7 mm, FIPS	820572-001
	500 GB, 7200 rpm, 7 mm, Opal-2	820573-001
	500 GB, 7200 rpm, 7 mm	703267-001
	500 GB, 5400 rpm, 7 mm, hybrid, 8 GB cache	732000-001
(6)	Battery	800514-001
(7)	Memory modules	
	4-GB (2133-MHz, DDR4)	820569-001
	8-GB (2133-MHz, DDR4)	820570-001
(8)	WLAN/Bluetooth combo card	
	Intel Dual Band Wireless-AC 3165 802.11ac 1x1 WiFi + BT 4.0 combo adapter	806723-001
	Intel Dual Band Wireless-AC 8260NGW 802.11a/g/n+ac 2x2 WiFi + BT 4.2 combo adapter	806721-001
	Intel Dual Band Wireless-AC 8260NGW 802.11a/b/g/n+ac non-vPro 2x2 WiFi + BT 4.2 combo adapter	806722-001
(9)	WWAN module	
	HP lt4120 LTE/EVDO/HSPA+ SnapdragonT X5 LTE Mobile Broadband Module	800870-001
	HP hs31110 HSPA + Intel Mobile Broadband Module	822828-001
(10)	Solid-state drive (SSD)	
	512 GB, SATA-3 TLC	840633-001
	256 GB, PCIe 3x4	821683-001
	256 GB, SATA-3 self-encrypting drive Opal-2	821680-001
	256 GB, SATA-3 TLC	821681-001
	240 GB, SATA-3	831760-001
	180 GB, SATA-3, self-encrypting drive Opal-2	821679-001
	180 GB, SATA-3	821678-001
	128 GB, SATA-3 TLC	821677-001
(11)	Smart card reader board (includes cable)	821695-001
(12)	Touchpad button board	
	Touchpad button board	821668-001
	Touchpad button board w/NFC antenna	821667-001
(13)	NFC module	821666-001
(14)	Fingerprint reader board (includes cable, bracket, and bezel)	821693-001
(15)	Heat sink/fan assembly	821691-001

Item	Component	Spare part number
(16)	System board (includes processor and replacement thermal material, see System board on page 49)	
(17)	RTC battery	702853-001
(18)	Speaker assembly (includes cable)	821684-001
(19)	Bottom cover	821662-001

Display assembly subcomponents

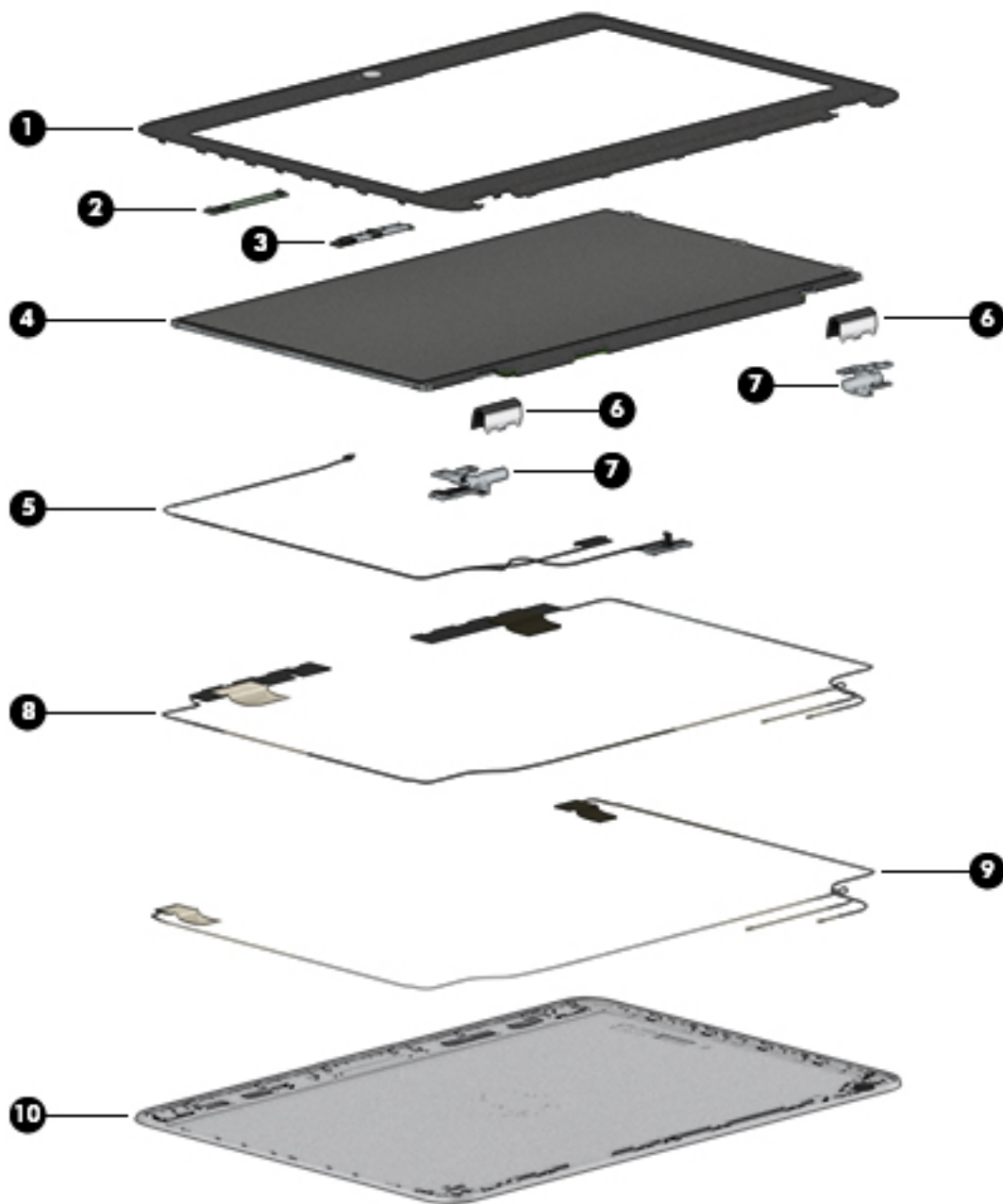

Item	Component	Spare part number
(1)	Bezel	821658-001
(2)	Microphone module	821696-001
(3)	Webcam module (includes microphone and cable)	821676-001
(4)	Raw panel	
	HD	821655-001
	FHD	821656-001

Item	Component	Spare part number
(5)	Display cable (spared with the cable kit)	
(6)	Hinge covers (spared with the plastics kit)	
(7)	Hinges	821674-001
(8)	WWAN antenna (spared with back cover)	
(9)	WLAN antenna (spared with back cover)	
(10)	Back cover (includes antennas)	821672-001

Plastics kit

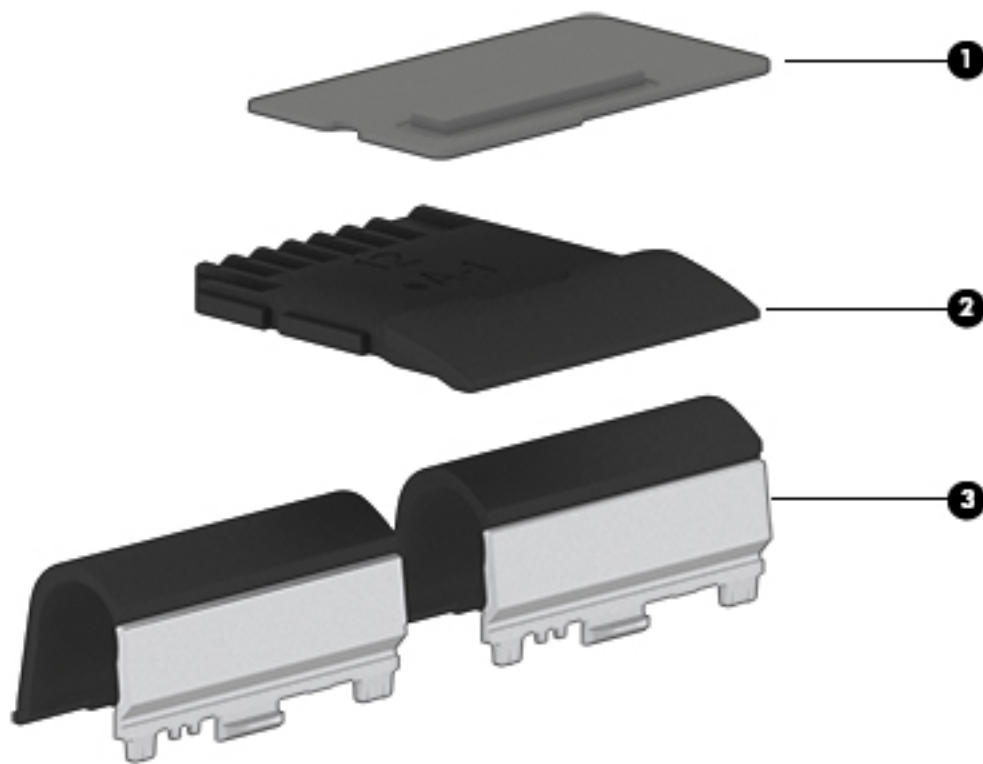

Item	Component	Spare part number
	Plastics kit	821675-001
(1)	Fingerprint reader blank (includes bracket)	
(2)	SD card blank	
(3)	Hinge covers	
	Silicone rubber bumpers (not shown)	

Cable kit

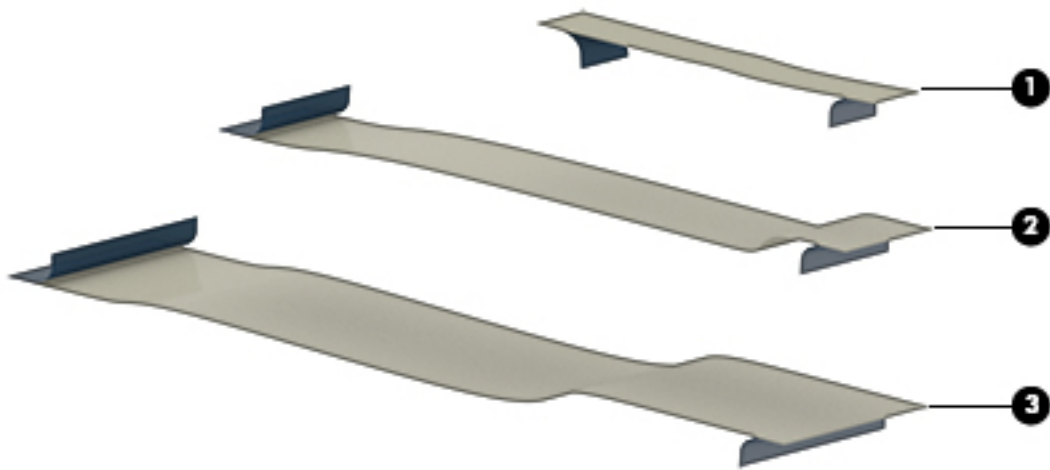

Item	Component	Spare part number
	Cable kit	821669-001
(1)	NFC module cable	
(2)	Pointing stick cable	
(3)	Display cable	

Mass storage devices

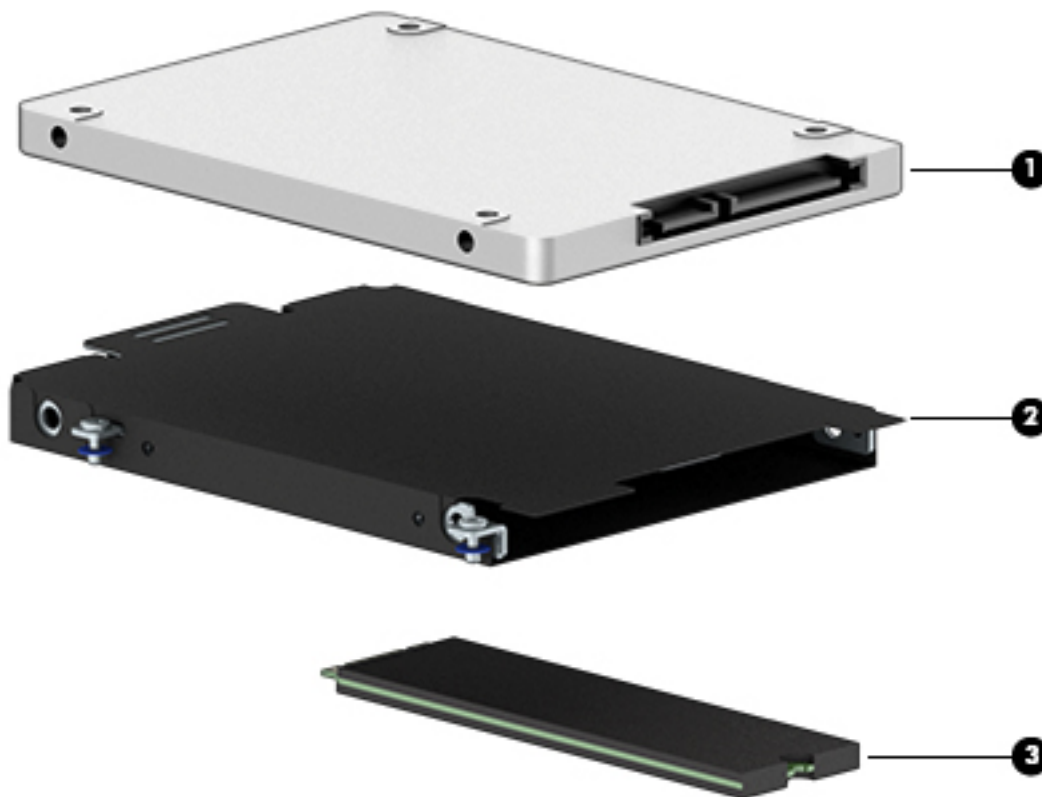

Item	Component	Spare part number
(1)	Hard drive	
	1 TB, 5400 rpm, 7 mm	762990-001
	500 GB, 7200 rpm, 7 mm, FIPS	820572-001
	500 GB, 7200 rpm, 7 mm, Opal-2	820573-001
	500 GB, 7200 rpm, 7 mm	703267-001
	500 GB, 5400 rpm, 7 mm, hybrid, 8 GB cache	732000-001
(2)	Hard drive hardware kit	821665-001
(3)	Solid-state drive (SSD)	
	512 GB, SATA-3 TLC	840633-001
	256 GB, PCIe 3x4	821683-001
	256 GB, SATA-3 self-encrypting drive Opal-2	821680-001
	256 GB, SATA-3 TLC	821681-001
	240 GB, SATA-3	831760-001
	180 GB, SATA-3, self-encrypting drive Opal-2	821679-001

Item	Component	Spare part number
	180 GB, SATA-3	821678-001
	128 GB, SATA-3 TLC	821677-001

Miscellaneous parts

Component	Spare part number
AC adapter:	
65 W Smart Adapter RC/V, emerging markets	693710-001
65 W Smart Adapter NPFC	693711-001
65 W Adapter NPFC S-3P	710412-001
65 W Smart Adapter NPFC, emerging markets	714657-001
45 W Smart Adapter NPFC nSlim	741727-001
45 W Smart Adapter NPFC 2-prong	742436-001
HP Smart AC Adapter 4.5 mm to 7.4 mm adapter	734734-001
HP DisplayPort to HDMI 1.4 Adapter	749288-001
HP Essential Top Load Case	679921-001
HP Business Top Load Case	718550-001
HP Slim Ultrabook Top Load Case	747078-001
Docking station	732252-001
Cable lock docking station	575921-001
HP Ultralim Keyed Cable Lock	703372-001
HP USB Laser Mouse	674318-001
HP Comfort Grip Wireless Mouse	691922-001
HP USB Travel Mouse	757770-001
HP Mobile Connect	714749-001
Power cord (3-pin, black, 1.83 m):	
For use in Argentina	490371-D01
For use in Australia	490371-011
For use in Brazil	490371-202
For use in Denmark	490371-081
For use in Europe	490371-021
For use in India	490371-D61
For use in Israel	490371-BB1
For use in Italy	490371-061

Component	Spare part number
For use in Japan	490371-291
For use in North America	490371-001
For use in the People's Republic of China	490371-AA1
For use in South Africa	490371-AR1
For use in South Korea	490371-AD1
For use in Switzerland	490371-111
For use in Taiwan	490371-AB1
For use in Thailand	490371-201
For use in the United Kingdom	490371-031
Power cord (3-pin, black, 1 m):	
For use in Argentina	755530-D01
For use in Australia	755530-011
For use in Brazil	755530-202
For use in Denmark	755530-081
For use in Europe	755530-021
For use in India	755530-D61
For use in Israel	755530-BB1
For use in Italy	755530-061
For use in Japan	755530-291
For use in North America	755530-001
For use in the People's Republic of China	755530-AA1
For use in South Africa	755530-AR1
For use in South Korea	755530-AD1
For use in Switzerland	755530-111
For use in Taiwan	755530-AB1
For use in Thailand	755530-201
For use in the United Kingdom	755530-031
Power cord (2-pin, black, 1.0 m): For use in Japan	762689-291
Rubber kit (includes pointing stick cover)	828884-001
Screw kit	821664-001

4 Removal and replacement procedures preliminary requirements

Tools required

You will need the following tools to complete the removal and replacement procedures:

- Flat-bladed screwdriver
- Magnetic screwdriver
- Phillips P0 and P1 screwdrivers

Service considerations

The following sections include some of the considerations that you must keep in mind during disassembly and assembly procedures.

 **NOTE:** As you remove each subassembly from the computer, place the subassembly (and all accompanying screws) away from the work area to prevent damage.

Plastic parts

 **CAUTION:** Using excessive force during disassembly and reassembly can damage plastic parts. Use care when handling the plastic

Cables and connectors

⚠ CAUTION: When servicing the computer, be sure that cables are placed in their proper locations during the reassembly process. Improper cable placement can damage the computer.

Cables must be handled with extreme care to avoid damage. Apply only the tension required to unseat or seat the cables during removal and insertion. Handle cables by the connector whenever possible. In all cases, avoid bending, twisting, or tearing cables. Be sure that cables are routed in such a way that they cannot be caught or snagged by parts being removed or replaced. Handle flex cables with extreme care; these cables tear easily.

Drive handling

⚠ CAUTION: Drives are fragile components that must be handled with care. To prevent damage to the computer, damage to a drive, or loss of information, observe these precautions:

Before removing or inserting a hard drive, shut down the computer. If you are unsure whether the computer is off or in Hibernation, turn the computer on, and then shut it down through the operating system.

Before handling a drive, be sure that you are discharged of static electricity. While handling a drive, avoid touching the connector.

Before removing a diskette drive or optical drive, be sure that a diskette or disc is not in the drive and be sure that the optical drive tray is closed.

Handle drives on surfaces covered with at least one inch of shock-proof foam.

Avoid dropping drives from any height onto any surface.

Avoid exposing an internal hard drive to products that have magnetic fields, such as monitors or speakers.

Avoid exposing an internal hard drive to products that have magnetic fields, such as monitors or speakers.

Avoid exposing a drive to temperature extremes or liquids.

If a drive must be mailed, place the drive in a bubble pack mailer or other suitable form of protective packaging and label the package "FRAGILE."

Grounding guidelines

Electrostatic discharge damage

Electronic components are sensitive to electrostatic discharge (ESD). Circuitry design and structure determine the degree of sensitivity. Networks built into many integrated circuits provide some protection, but in many cases, ESD contains enough power to alter device parameters or melt silicon junctions.

A discharge of static electricity from a finger or other conductor can destroy static-sensitive devices or microcircuitry. Even if the spark is neither felt nor heard, damage may have occurred.

An electronic device exposed to ESD may not be affected at all and can work perfectly throughout a normal cycle. Or the device may function normally for a while, then degrade in the internal layers, reducing its life expectancy.

CAUTION: To prevent damage to the computer when you are removing or installing internal components, observe these precautions:

Keep components in their electrostatic-safe containers until you are ready to install them.

Before touching an electronic component, discharge static electricity by using the guidelines described in this section.

Avoid touching pins, leads, and circuitry. Handle electronic components as little as possible.

If you remove a component, place it in an electrostatic-safe container.

The following table shows how humidity affects the electrostatic voltage levels generated by different activities.

CAUTION: A product can be degraded by as little as 700 V.

Typical electrostatic voltage levels			
Event	Relative humidity		
	10%	40%	55%
Walking across carpet	35,000 V	15,000 V	7,500 V
Walking across vinyl floor	12,000 V	5,000 V	3,000 V
Motions of bench worker	6,000 V	800 V	400 V
Removing DIPS from plastic tube	2,000 V	700 V	400 V
Removing DIPS from vinyl tray	11,500 V	4,000 V	2,000 V
Removing DIPS from Styrofoam	14,500 V	5,000 V	3,500 V
Removing bubble pack from PCB	26,500 V	20,000 V	7,000 V
Packing PCBs in foam-lined box	21,000 V	11,000 V	5,000 V

Packaging and transporting guidelines

Follow these grounding guidelines when packaging and transporting equipment:

- To avoid hand contact, transport products in static-safe tubes, bags, or boxes.
- Protect ESD-sensitive parts and assemblies with conductive or approved containers or packaging.
- Keep ESD-sensitive parts in their containers until the parts arrive at static-free workstations.
- Place items on a grounded surface before removing items from their containers.
- Always be properly grounded when touching a component or assembly.
- Store reusable ESD-sensitive parts from assemblies in protective packaging or nonconductive foam.
- Use transporters and conveyors made of antistatic belts and roller bushings. Be sure that mechanized equipment used for moving materials is wired to ground and that proper materials are selected to avoid static charging. When grounding is not possible, use an ionizer to dissipate electric charges.

Workstation guidelines

Follow these grounding workstation guidelines:

- Cover the workstation with approved static-shielding material.
- Use a wrist strap connected to a properly grounded work surface and use properly grounded tools and equipment.
- Use conductive field service tools, such as cutters, screwdrivers, and vacuums.
- When fixtures must directly contact dissipative surfaces, use fixtures made only of static safe materials.
- Keep the work area free of nonconductive materials, such as ordinary plastic assembly aids and Styrofoam.
- Handle ESD-sensitive components, parts, and assemblies by the case or PCM laminate. Handle these items only at static-free workstations.
- Avoid contact with pins, leads, or circuitry.
- Turn off power and input signals before inserting or removing connectors or test equipment.

Equipment guidelines

Grounding equipment must include either a wrist strap or a foot strap at a grounded workstation.

- When seated, wear a wrist strap connected to a grounded system. Wrist straps are flexible straps with a minimum of one megohm $\pm 10\%$ resistance in the ground cords. To provide proper ground, wear a strap snugly against the skin at all times. On grounded mats with banana-plug connectors, use alligator clips to connect a wrist strap.
- When standing, use foot straps and a grounded floor mat. Foot straps (heel, toe, or boot straps) can be used at standing workstations and are compatible with most types of shoes or boots. On conductive floors or dissipative floor mats, use foot straps on both feet with a minimum of one megohm resistance between the operator and ground. To be effective, the conductive must be worn in contact with the skin.

The following grounding equipment is recommended to prevent electrostatic damage:

- Antistatic tape
- Antistatic smocks, aprons, and sleeve protectors
- Conductive bins and other assembly or soldering aids
- Nonconductive foam
- Conductive tabletop workstations with ground cords of one megohm resistance
- Static-dissipative tables or floor mats with hard ties to the ground
- Field service kits
- Static awareness labels
- Material-handling packages
- Nonconductive plastic bags, tubes, or boxes
- Metal tote boxes
- Electrostatic voltage levels and protective materials

The following table lists the shielding protection provided by antistatic bags and floor mats.

Material	Use	Voltage protection level
Antistatic plastics	Bags	1,500 V
Carbon-loaded plastic	Floor mats	7,500 V
Metallized laminate	Floor mats	5,000 V

5 Removal and replacement procedures for Customer Self-Repair parts

This chapter provides removal and replacement procedures for Customer Self-Repair parts.

 **NOTE:** The Customer Self-Repair program is not available in all locations. Installing a part not supported by the Customer Self-Repair program may void your warranty. Check your warranty to determine if Customer Self-Repair is supported in your location.

Component replacement procedures

 **NOTE:** Details about your computer, including model, serial number, product key, and length of warranty, are on the service tag at the bottom of your computer. See [Locating system information on page 16](#) for details.

 **NOTE:** HP continually improves and changes product parts. For complete and current information on supported parts for your computer, go to <http://partsurfer.hp.com>, select your country or region, and then follow the on-screen instructions.

There are as many as xx screws that must be removed, replaced, and/or loosened when servicing Customer Self-Repair parts. Make special note of each screw size and location during removal and replacement.

Bottom cover

Description	Spare part number
Bottom cover	821662-001

Before removing the bottom cover, follow these steps:

1. Turn off the computer. If you are unsure whether the computer is off or in Hibernation, turn the computer on, and then shut it down through the operating system.
2. Disconnect the power from the computer by unplugging the power cord from the computer.
3. Disconnect all external devices from the computer.

Remove the bottom cover:

1. Turn the computer upside down on a flat surface.

2. Remove the 11 rubber plugs **(1)** and the 11 Phillips PM2.5x5.0 screws beneath them **(2)** from the bottom cover.

Be sure to remove the screws in the following order.

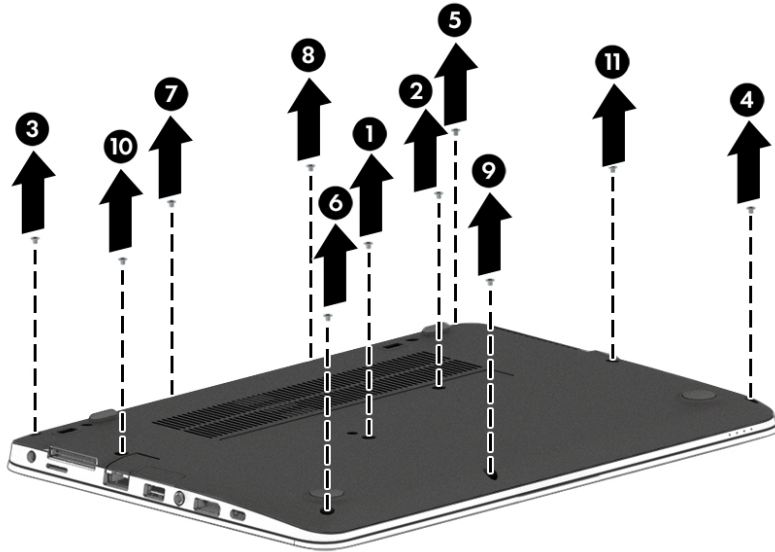

3. Remove the SD card blank and the 1 PM2.0x7.0 screw beneath it **(3)** that secures the bottom cover to the computer.

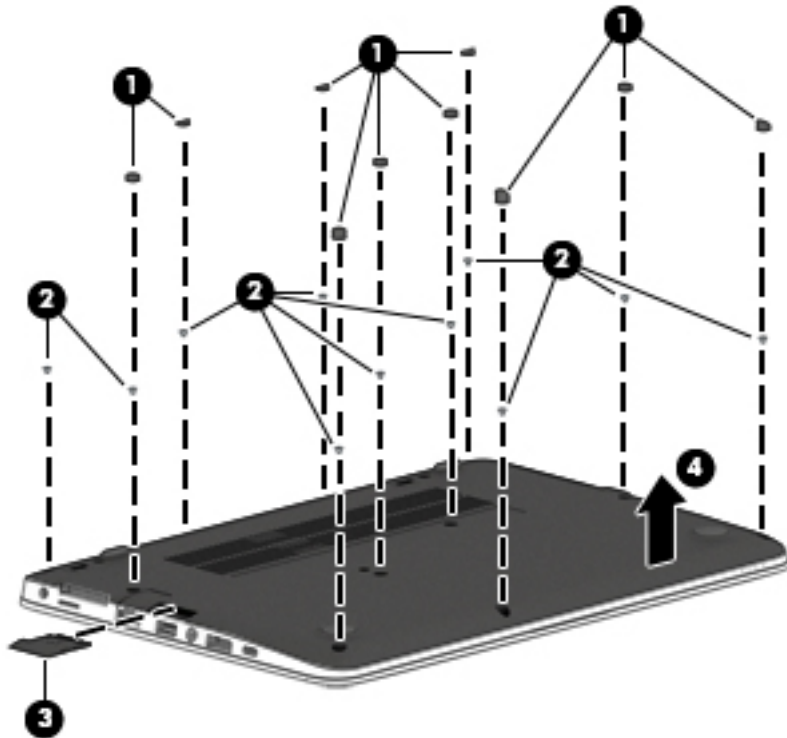

4. Pry up on the top (near the display hinge) of the bottom cover to disengage it from the computer **(4)**.

Reverse the removal procedures to install the bottom cover.

 **NOTE:** There are four different sizes of rubber plugs. Be sure that you reinstall them over the correct screws.

The rubber-plug sizes are as follows.

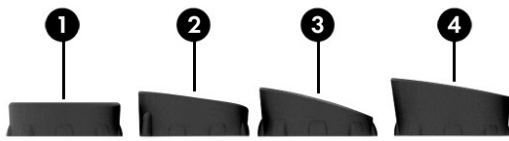

The rubber-plug locations are as follows.

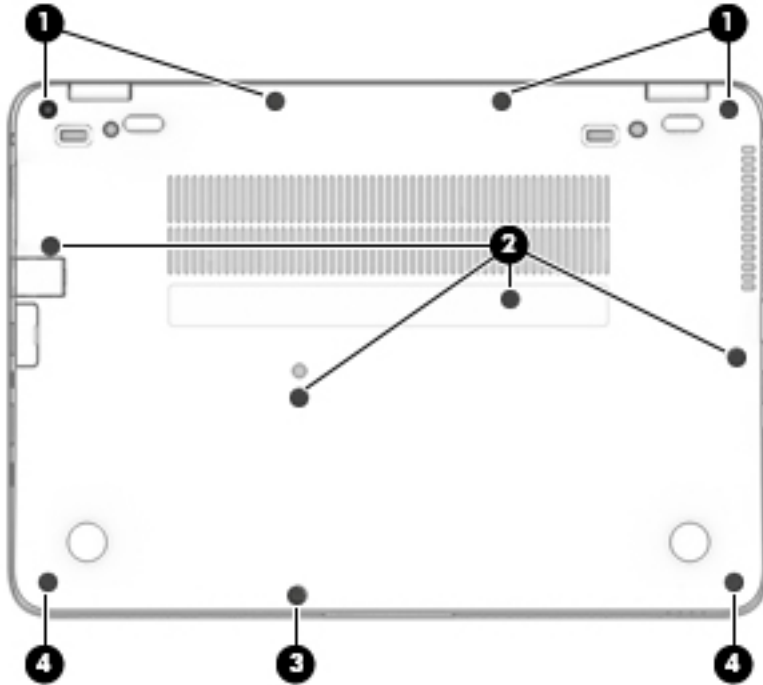

Battery

Description	Spare part number
3-cell, 44 WHr, 3.91 Ah Li-ion battery	800514-001

Before removing the battery, follow these steps:

1. Turn off the computer. If you are unsure whether the computer is off or in Hibernation, turn the computer on, and then shut it down through the operating system.
2. Disconnect the power from the computer by unplugging the power cord from the computer.
3. Disconnect all external devices from the computer.
4. Remove the bottom cover (see [Bottom cover on page 32](#)).

To remove the battery:

- ⚠ **WARNING!** To reduce potential safety issues, use only the user-replaceable battery provided with the computer, a replacement battery provided by HP, or a compatible battery purchased from HP.
- ⚠ **CAUTION:** Removing a user-replaceable battery that is the sole power source for the computer can cause loss of information. To prevent loss of information, save your work or shut down the computer through Windows before removing the battery.

- ▲ Loosen the captive screw **(1)** and lift the tab to remove the battery from the computer **(2)**.

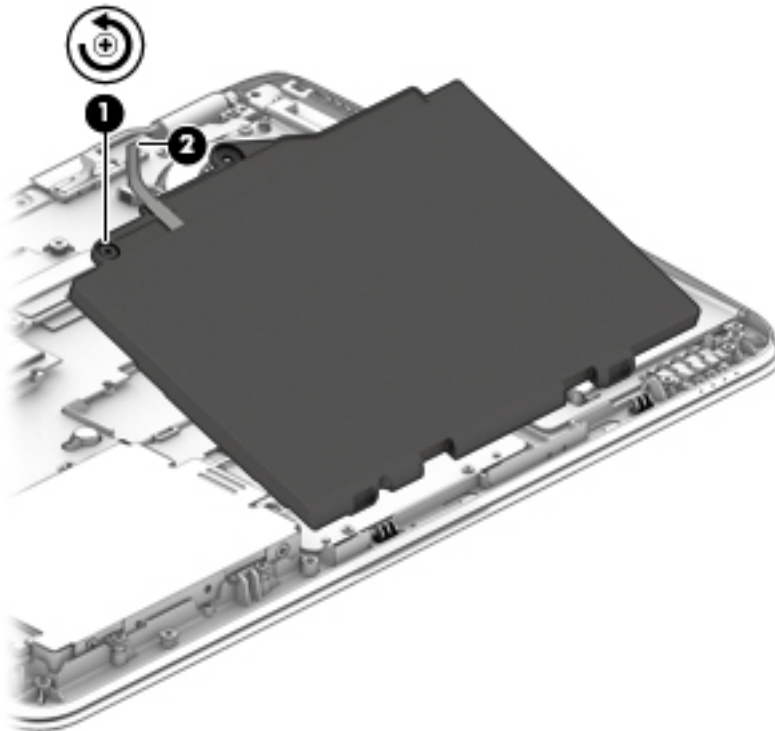

To insert the battery, reverse the removal procedures.

Hard drive

Description	Spare part number
1 TB, 5400 rpm, 7 mm	762990-001
500 GB, 7200 rpm, 7 mm, FIPS	820572-001
500 GB, 7200 rpm, 7 mm, Opal-2	820573-001
500 GB, 7200 rpm, 7 mm	703267-001
500 GB, 5400 rpm, 7 mm, hybrid, 8 GB cache	732000-001

Before removing the hard drive, follow these steps:

1. Shut down the computer. If you are unsure whether the computer is off or in Hibernation, turn the computer on, and then shut it down through the operating system.
2. Disconnect all external devices connected to the computer.
3. Disconnect the power from the computer by first unplugging the power cord from the AC outlet, and then unplugging the AC adapter from the computer.
4. Remove the bottom cover (see [Bottom cover on page 32](#)).
5. Remove the battery (see [Battery on page 35](#)).

To remove a hard drive:

1. Loosen the 4 captive screws **(1)** that secure the hard drive to the chassis.
2. Slide the hard drive **(2)** away from the center of the computer to disengage it from the connector.
3. Lift to remove the hard drive from the bay **(3)**.

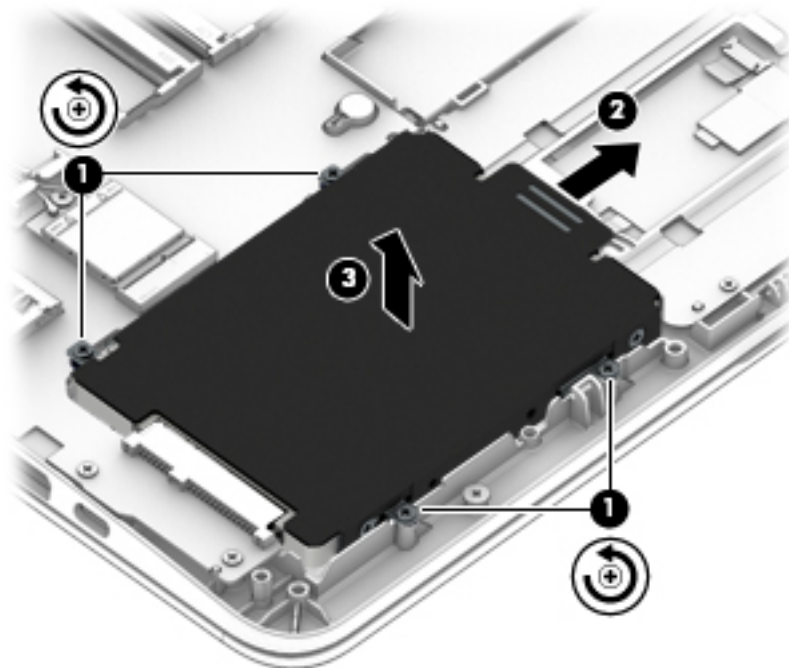

4. To remove the hard drive cover and bracket from the hard drive, lift the Mylar cover up off the drive, remove the 4 Phillips PM3.0×3.0 screws (1) that secure the bracket to the drive, and then lift the bracket up and off the hard drive (2).

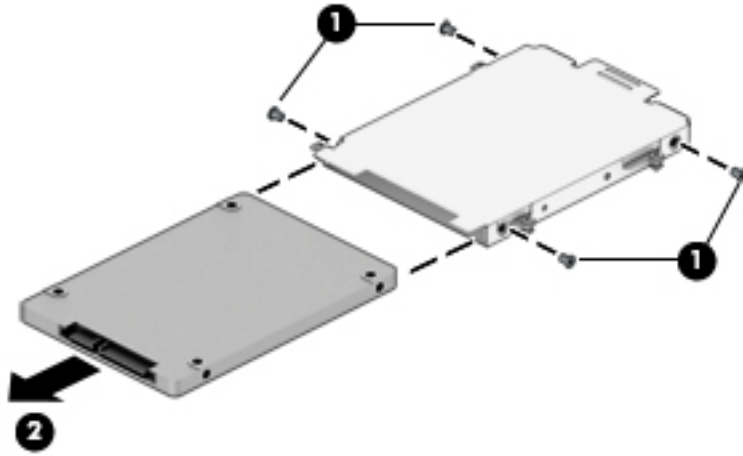

Reverse this procedure to install a hard drive.

 **NOTE:** Only a hard drive or an SSD can be installed. To install a hard drive, be sure that the standee is stored beside the hard drive slot and not installed across from the SSD connector.

SSD

Description	Spare part number
Solid-state drive	
512 GB, SATA-3 TLC	840633-001
256 GB, PCIe 3x4	821683-001
256 GB, SATA-3 self-encrypting drive Opal-2	821680-001
256 GB, SATA-3 TLC	821681-001
240 GB, SATA-3	831760-001
180 GB, SATA-3, self-encrypting drive Opal-2	821679-001
180 GB, SATA-3	821678-001
128 GB, SATA-3 TLC	821677-001

Before removing the SSD, follow these steps:

1. Turn off the computer. If you are unsure whether the computer is off or in Hibernation, turn the computer on, and then shut it down through the operating system.
2. Disconnect the power from the computer by unplugging the power cord from the computer.
3. Disconnect all external devices from the computer.
4. Remove the bottom cover (see [Bottom cover on page 32](#)).
5. Disconnect the battery (see [Battery on page 35](#)).

Remove the SSD:

1. Remove the Phillips PM2.0×3.0 screw **(1)** that secures the drive to the system board.

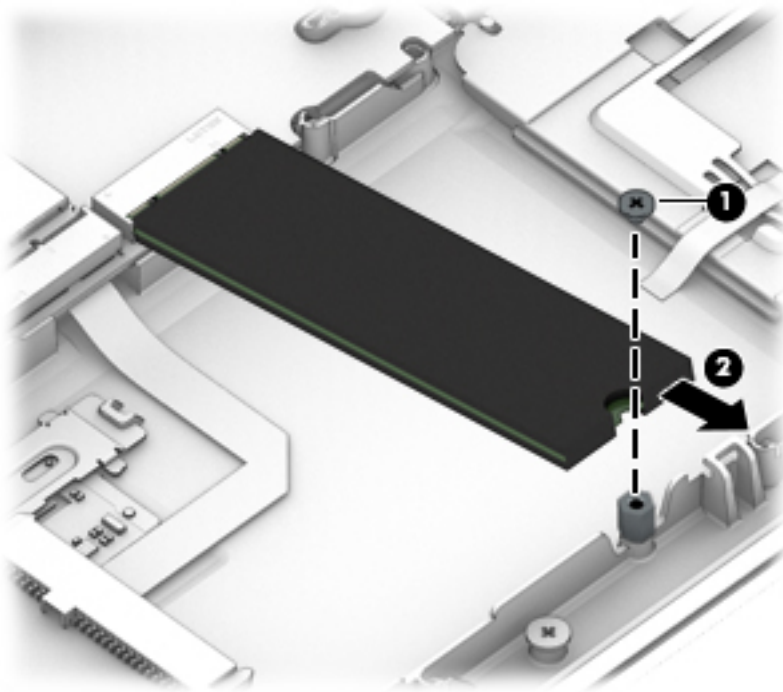

2. Remove the drive **(2)** by pulling it away from the connector.

 **NOTE:** mSATA drives are designed with notches to prevent incorrect insertion.

Reverse this procedure to reassemble and install the mSATA drive.

 **NOTE:** Only a hard drive or an SSD can be installed. To install an SSD, be sure that the standee is in place across from the connector and not stored beside the hard drive slot.

Memory modules

 **NOTE:** Primary and expansion memory is installed in a side-by-side configuration in the bottom of the computer.

If only one memory module is installed, it must be installed in the socket labeled 1.

Description	Spare part number
4-GB (2133-MHz, DDR4)	820569-001
8-GB (2133-MHz, DDR4)	820570-001

Update BIOS before adding memory modules

Before adding new memory, make sure you update the computer to the latest BIOS.

 **CAUTION:** Failure to update the computer to the latest BIOS prior to installing new memory may result in various system problems.

To update BIOS:

1. Navigate to www.hp.com.
2. Click **Support & Drivers** > click **Drivers & Software**.
3. In the **Enter a product name/number** box, type the computer model information, and then click **Search**.
4. Click the link for the computer model.
5. Select the operating system, and then click **Next**.
6. Under **Step 2: Select a Download**, click the **BIOS** link.
7. Click the link for the most recent BIOS.
8. Click the **Download** button, and then follow the on-screen instructions.

Before removing the memory module, follow these steps:

1. Shut down the computer. If you are unsure whether the computer is off or in Hibernation, turn the computer on, and then shut it down through the operating system.
2. Disconnect all external devices connected to the computer.
3. Disconnect the power from the computer by first unplugging the power cord from the AC outlet, and then unplugging the AC adapter from the computer.
4. Remove the bottom cover (see [Bottom cover on page 32](#)).
5. Remove the battery (see [Battery on page 35](#)).

Remove the memory module:

1. Spread the retaining tabs **(1)** on each side of the memory module slot to release the memory module. (The edge of the module opposite the slot rises away from the computer.)

2. Remove the memory module **(2)** by pulling the module away from the slot at an angle.

 **NOTE:** Memory modules are designed with a notch to prevent incorrect insertion into the memory module slot.

 **NOTE:** The computer uses two memory sockets. The socket labeled 2 houses the expansion memory module and the socket labeled 1 houses the primary memory module. The removal procedure is the same for both memory sockets.

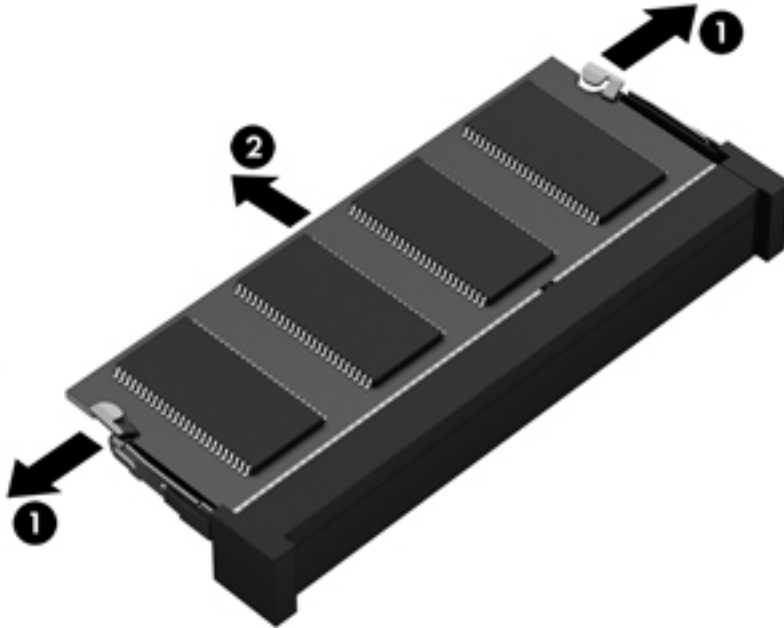

Reverse this procedure to install a memory module.

WLAN/Bluetooth combo card

The computer uses a card that provides both WLAN and Bluetooth functionality.

The WLAN module and WWAN module are not interchangeable.

Description	Spare part number
Intel Dual Band Wireless-AC 3165 802.11ac 1x1 WiFi + BT 4.0 combo adapter	806723-001
Intel Dual Band Wireless-AC 8260NGW 802.11a/g/g/n+ac 2x2 WiFi + BT 4.2 combo adapter	806721-001
Intel Dual Band Wireless-AC 8260NGW 802.11a/b/g/n+ac non-vPro 2x2 WiFi + BT 4.2 combo adapter	806722-001

Before removing the WLAN module, follow these steps:

1. Shut down the computer. If you are unsure whether the computer is off or in Hibernation, turn the computer on, and then shut it down through the operating system.
2. Disconnect all external devices connected to the computer.
3. Disconnect the power from the computer by first unplugging the power cord from the AC outlet, and then unplugging the AC adapter from the computer.
4. Remove the bottom cover (see [Bottom cover on page 32](#)).
5. Remove the battery (see [Battery on page 35](#)).

Remove the WLAN module:

1. Disconnect the WLAN antenna cables **(1)** from the terminals on the WLAN module.





NOTE: The WLAN antenna cable labeled “1” connects to the WLAN module “Main” terminal labeled “1”. The WLAN antenna cable labeled “2” connects to the WLAN module “Aux” terminal labeled “2”. If the computer is equipped with an 802.11a/b/g/n WLAN module, the yellow WLAN antenna cable connects to the middle terminal on the WLAN module.

2. Remove the one Phillips PM2.5×3.0 screw **(2)** that secures the WLAN module to the computer. (The edge of the module opposite the slot rises away from the computer.)

3. Remove the WLAN module by pulling the module away from the slot at an angle (3).

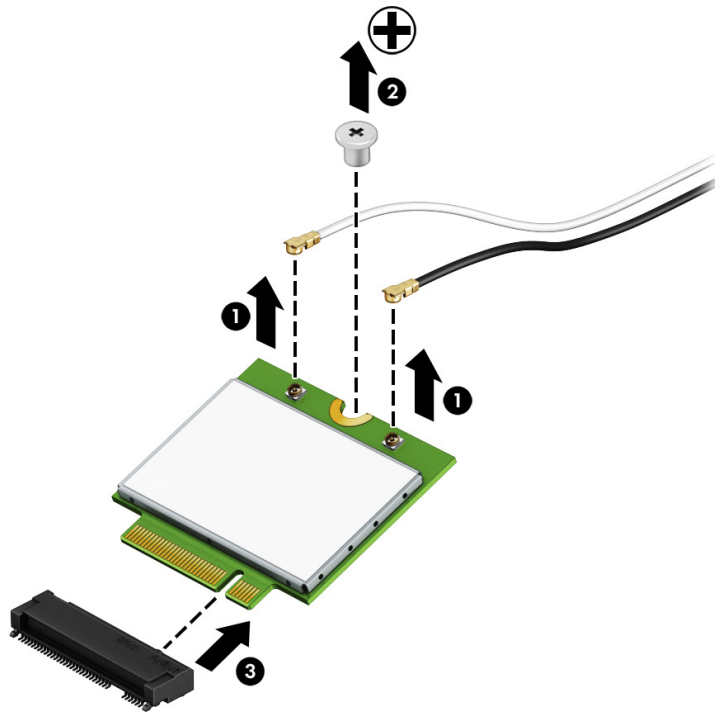
 **NOTE:** WLAN modules are designed with a notch to prevent incorrect insertion.



 **NOTE:** If the WLAN antennas are not connected to the terminals on the WLAN module, the protective sleeves must be installed on the antenna connectors, as shown in the following illustration.



Reverse this procedure to install the WLAN module.

WWAN module

The WLAN module and WWAN module are not interchangeable.

The WWAN module is available on select models only.

Description	Spare part number
HP It4120 LTE/EVDO/HSPA+ SnapdragonT X5 LTE Mobile Broadband Module	800870-001
HP hs31110 HSPA + Intel Mobile Broadband Module	822828-001

Before removing the WWAN module, follow these steps:

1. Shut down the computer. If you are unsure whether the computer is off or in Hibernation, turn the computer on, and then shut it down through the operating system.
2. Disconnect all external devices connected to the computer.
3. Disconnect the power from the computer by first unplugging the power cord from the AC outlet, and then unplugging the AC adapter from the computer.
4. Remove the bottom cover (see [Bottom cover on page 32](#)).
5. Remove the battery (see [Battery on page 35](#)).

Remove the WWAN module:

1. Position the computer upside-down.
2. Disconnect the WWAN antenna cables **(1)** from the terminals on the WWAN module.





NOTE: The red WWAN antenna cable is connected to the WWAN module “Main” terminal. The blue WWAN antenna cable is connected to the WWAN module “Aux” terminal.

3. Remove the one Phillips PM2.5×3.0 screws **(2)** that secure the WWAN module to the computer. (The edge of the module opposite the slot rises away from the computer.)

4. Remove the WWAN module (3) by pulling the module away from the slot at an angle.

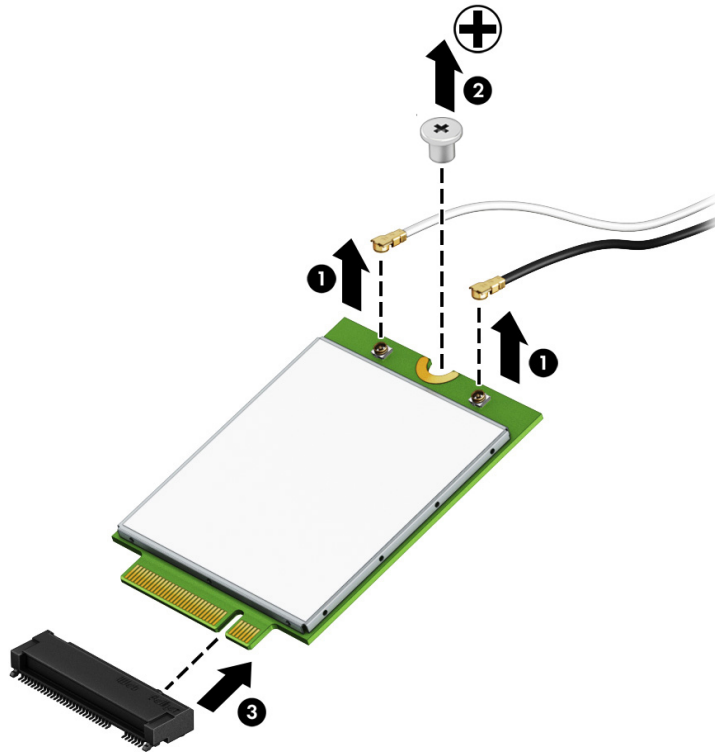
 **NOTE:** WWAN modules are designed with a notch to prevent incorrect insertion.



 **NOTE:** If the WWAN antennas are not connected to the terminals on the WWAN module, the protective sleeves must be installed on the antenna connectors, as shown in the following illustration.



Reverse this procedure to install the WWAN module.

Keyboard

In this section, the first table provides the main spare part number for the keyboards. The second table provides the country codes.

Description	Spare part number
Keyboard, no backlight	826631-xx1
Keyboard, backlit	826630-xx1

For use in country or region	Spare part number	For use in country or region	Spare part number	For use in country or region	Spare part number
Belgium	-A41	India	-D61	Slovenia	-BA1
Brazil	-201	Israel	-BB1	South Korea	-AD1
Bulgaria	-261	Italy	-061	Spain	-071
Canada	-DB1	Japan	-291	Sweden and Finland	-B71
Czech Republic and Slovakia	-FL1	Latin America	-161	Switzerland	-BG1
Denmark	-081	The Netherlands	-B31	Taiwan	-AB1
Denmark, Finland, and Norway	-DH1	Northern Africa	-FP1	Thailand	-281
France	-051	Norway	-091	Turkey	-141
Germany	-041	Portugal	-131	Turkey	-541
Greece	-151	Romania	-271	United Kingdom	-031
Hungary	-211	Russia	-251	United States	-001
Iceland	-DD1	Saudi Arabia	-171		

Before removing the keyboard, follow these steps:

1. Shut down the computer. If you are unsure whether the computer is off or in Hibernation, turn the computer on, and then shut it down through the operating system.
2. Disconnect all external devices connected to the computer.
3. Disconnect the power from the computer by first unplugging the power cord from the AC outlet, and then unplugging the AC adapter from the computer.
4. Remove the bottom cover (see [Bottom cover on page 32](#)).
5. Remove the battery (see [Battery on page 35](#)).

Remove the keyboard:

1. Remove the 2 Phillips PM2.5×3.0 screws that secure the keyboard to the computer **(1)**.
2. Position the computer upright with the front toward you.
3. Open the computer as far as possible.

4. Insert a screwdriver or similar thin tool into the hole beside the heat sink/fan assembly, and then press on the back of the keyboard until it disengages from the computer **(2)**. Rotate the top of the keyboard upward, and then lift the keyboard up at an angle to disengage the tabs at the bottom of the keyboard.

 **NOTE:** Cables connect the bottom of the keyboard to the system board. Make sure not to prematurely pull the keyboard cables out of the system board connectors.

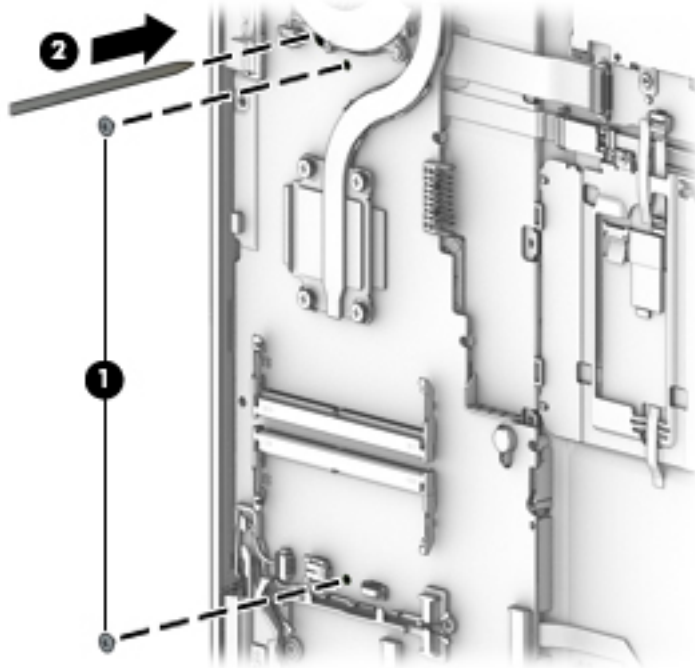

5. Slide the keyboard slightly downward toward the palm rest to disengage the top of the keyboard from the top cover **(1)**. Remove the pointing stick cable **(2)**, the keyboard backlight cable **(3)**, and the keyboard cable **(4)**.

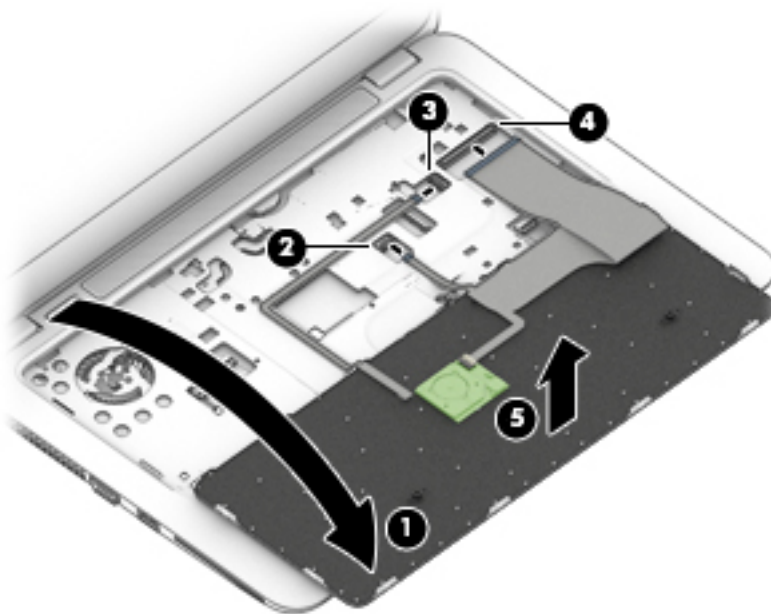

6. Remove the keyboard **(5)**.

Reverse this procedure to install the keyboard.

6 Removal and replacement procedures for Authorized Service Provider parts

This chapter provides removal and replacement procedures for Authorized Service Provider only parts.

 **CAUTION:** Components described in this chapter should only be accessed by an authorized service provider. Accessing these parts can damage the computer or void the warranty.

CAUTION: This computer does not have user-replaceable parts. Only HP authorized service providers should perform the removal and replacement procedures described here. Accessing the internal part could damage the computer or void the warranty.

Component replacement procedures

 **NOTE:** Details about your computer, including model, serial number, product key, and length of warranty, are on the service tag at the bottom of your computer. See [Locating system information on page 16](#) for details.

 **NOTE:** HP continually improves and changes product parts. For complete and current information on supported parts for your computer, go to <http://partsurfer.hp.com>, select your country or region, and then follow the on-screen instructions.

There are as many as xx screws that must be removed, replaced, and/or loosened when servicing Authorized Service Provider only parts. Make special note of each screw size and location during removal and replacement.

System board

 **NOTE:** All system board spare part kits include replacement thermal material.

All system boards use the following part numbers:

xxxxxx-001: Non-Windows operating systems

xxxxxx-601: Windows operating system

Description	Spare part number
Intel i7-6600U; UMA graphics memory	831765-xxx
Intel i7-6500U; UMA graphics memory	831764-xxx
Intel i5-6300U; UMA graphics memory	831763-xxx
Intel i5-6200U; UMA graphics memory	831762-xxx
Intel i3-6100U; UMA graphics memory	831761-xxx

Before removing the system board, follow these steps:

1. Shut down the computer. If you are unsure whether the computer is off or in Hibernation, turn the computer on, and then shut it down through the operating system.
2. Disconnect all external devices connected to the computer.
3. Disconnect the power from the computer by first unplugging the power cord from the AC outlet, and then unplugging the AC adapter from the computer.
4. Remove the bottom cover (see [Bottom cover on page 32](#)).
5. Remove the battery (see [Battery on page 35](#)).
6. Remove the following components:
 - a. Keyboard (see [Keyboard on page 46](#))
 - b. Hard drive (see [Hard drive on page 36](#))
 - c. SSD (see [SSD on page 38](#))

When replacing the system board, be sure to remove the following components from the defective system board and install on the replacement system board:

- Memory modules (see [Memory modules on page 40](#))
- WLAN/Bluetooth module (see [WLAN/Bluetooth combo card on page 42](#))
- WWAN module (see [WWAN module on page 44](#))
- RTC battery (see [RTC battery on page 52](#))
- Heat sink/ fan assembly (see [Heat sink/fan assembly on page 53](#))

Remove the system board:

1. Disconnect the following cables from the system board:
 - (1) Speaker cable
 - (2) WLAN cables
 - (3) WWAN cables
 - (4) Display cable

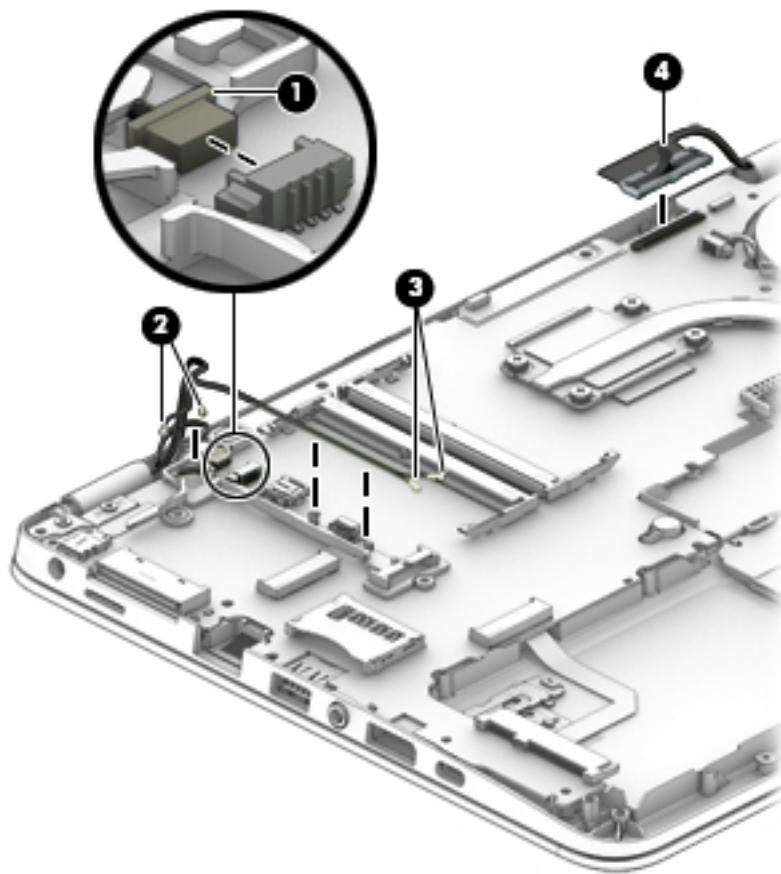

2. Remove the 4 Phillips PM2.5×5.0 screws **(1)** that secure the system board to the computer.

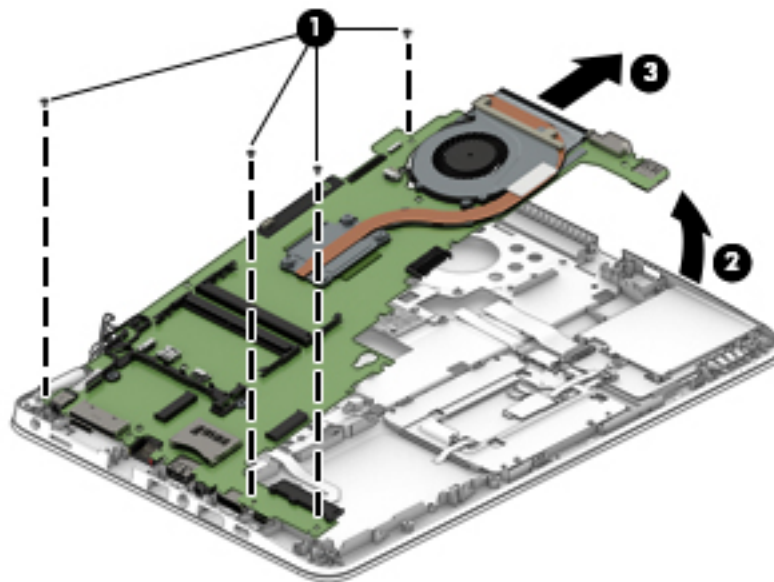

3. Lift the right side of the system board up at an angle **(2)**.
4. Pull the system board up and toward the right to remove it from the computer **(3)**.

Reverse this procedure to install the system board.

RTC battery

Description	Spare part number
RTC battery	702853-001

Before removing the RTC battery, follow these steps:

1. Shut down the computer. If you are unsure whether the computer is off or in Hibernation, turn the computer on, and then shut it down through the operating system.
2. Disconnect all external devices connected to the computer.
3. Disconnect the power from the computer by first unplugging the power cord from the AC outlet, and then unplugging the AC adapter from the computer.
4. Remove the bottom cover (see [Bottom cover on page 32](#)).
5. Remove the battery (see [Battery on page 35](#)).
6. Remove the system board (see [System board on page 49](#)).

Remove the RTC battery:

1. Remove the RTC battery cable from the system board **(1)**.
2. Using a flat tool, pry the battery out of the socket **(2)**.

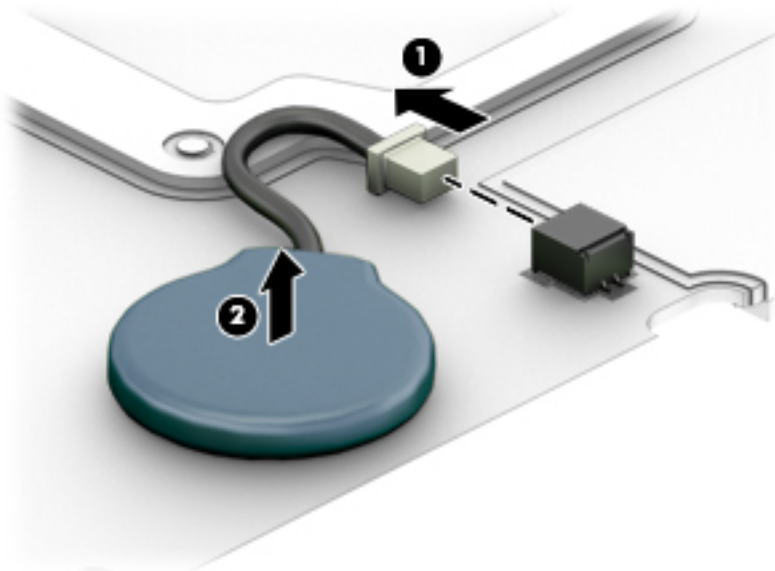

Reverse this procedure to install the RTC battery.

Heat sink/fan assembly

 **NOTE:** The heat sink/fan assembly spare part kit includes replacement thermal material.

Description	Spare part number
Heat sink/thermal module with fans	821691-001

Before removing the heat sink/fan assembly, follow these steps:

1. Turn off the computer. If you are unsure whether the computer is off or in Hibernation, turn the computer on, and then shut it down through the operating system.
2. Disconnect the power from the computer by unplugging the power cord from the computer.
3. Disconnect all external devices from the computer.
4. Bottom cover (see [Bottom cover on page 32](#)).
5. Remove the battery (see [Battery on page 35](#)).
6. Remove the system board (see [System board on page 49](#)).

Remove the heat sink/fan assembly:

- ▲ Disconnect the fan cable (1), loosen the six captive screws on the fan and heat sink following the sequence stamped on the heat sink (2), and then remove the heat sink/fan assembly from the system board (3).

 **CAUTION:** Take extreme care when removing the heat sink and fan assembly. The heatpipes between the fans are very fragile and can be easily damaged and bent during removal.

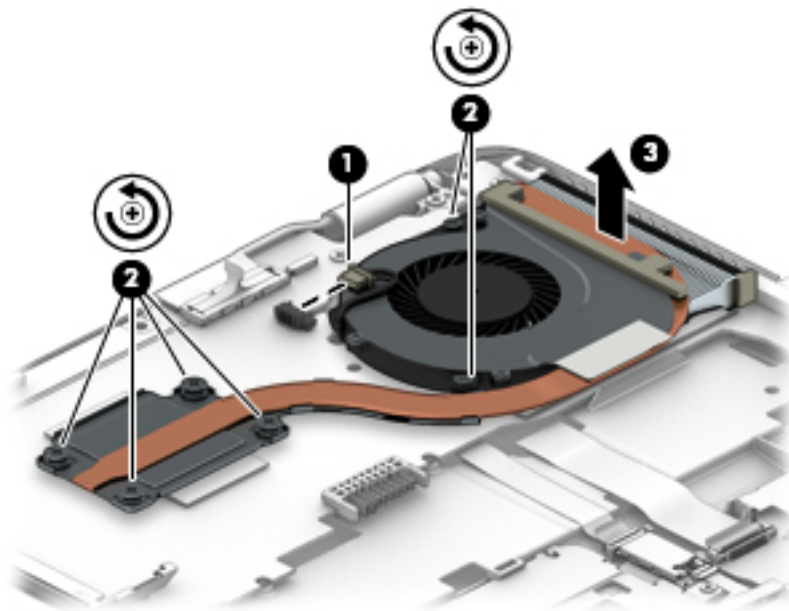

 **NOTE:** The thermal material must be thoroughly cleaned from the surfaces of the heat sink and the system board components each time the heat sink is removed. Replacement thermal material is included with the heat sink, processor, and system board spare part kits.

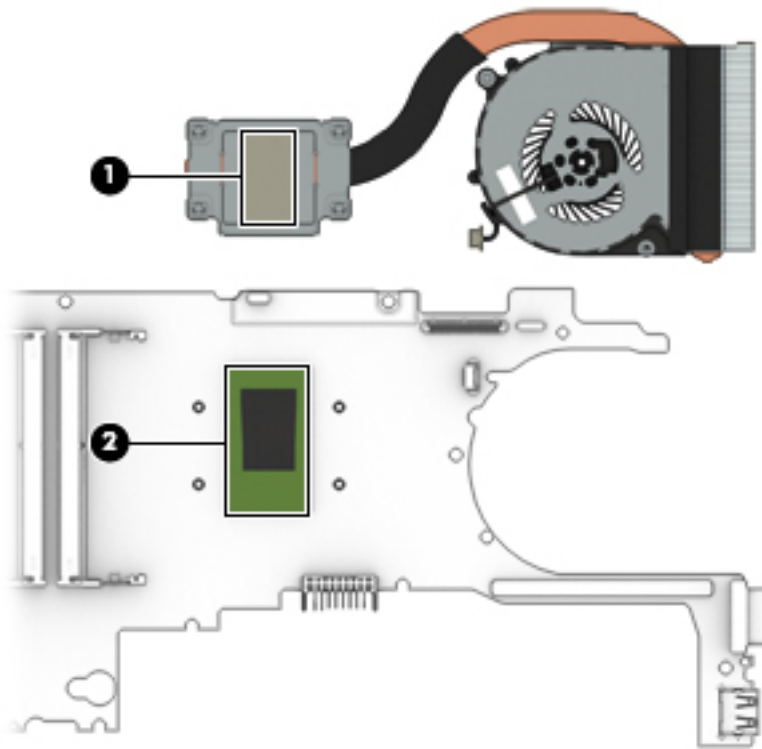

Reverse this procedure to install the heat sink/fan assembly.

Fingerprint reader assembly

Description	Spare part number
Fingerprint reader assembly (includes cable, bracket, and bezel)	821693-001

Before removing the fingerprint reader assembly, follow these steps:

1. Shut down the computer. If you are unsure whether the computer is off or in Hibernation, turn the computer on, and then shut it down through the operating system.
2. Disconnect all external devices connected to the computer.
3. Disconnect the power from the computer by first unplugging the power cord from the AC outlet, and then unplugging the AC adapter from the computer.
4. Remove the bottom cover (see [Bottom cover on page 32](#)).
5. Remove the battery (see [Battery on page 35](#)).
6. Remove the system board (see [System board on page 49](#)).

Remove the fingerprint reader assembly:

1. Remove the Phillips PM2.5x3.0 screw **(1)** that secures the bracket to the top cover.
2. Slide the bracket right, and then lift it off the top cover **(2)**.
3. Disconnect the fingerprint reader board cable from the system board.
4. Remove the fingerprint reader board and cable assembly from the top cover **(3)**.

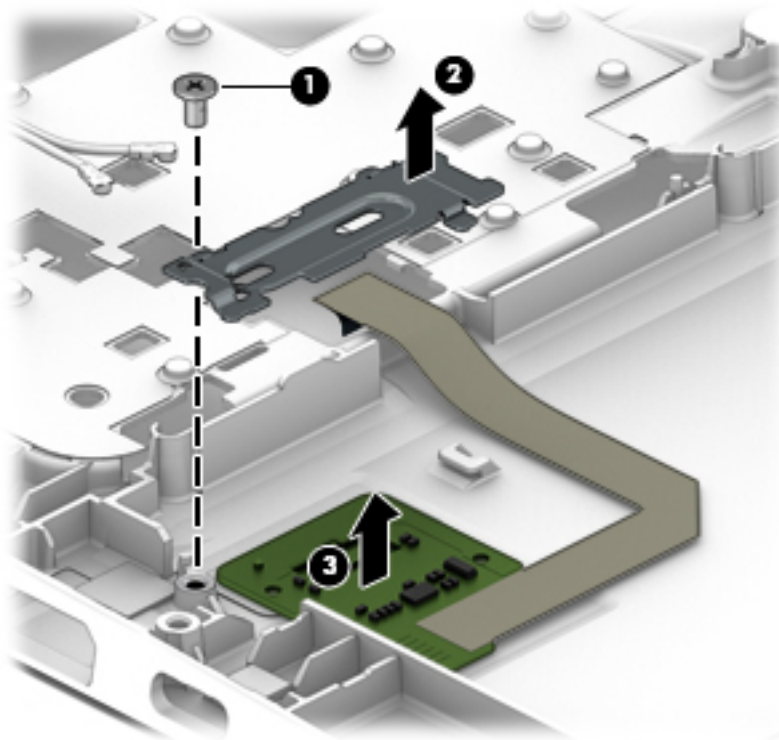

Reverse this procedure to install the fingerprint reader assembly.

Touchpad button board

Description	Spare part number
Touchpad button board	821668-001
Touchpad button board w/NFC antenna	821667-001

Before removing the touchpad button board, follow these steps:

1. Shut down the computer. If you are unsure whether the computer is off or in Hibernation, turn the computer on, and then shut it down through the operating system.
2. Disconnect all external devices connected to the computer.
3. Disconnect the power from the computer by first unplugging the power cord from the AC outlet, and then unplugging the AC adapter from the computer.
4. Remove the bottom cover (see [Bottom cover on page 32](#)).
5. Remove the battery (see [Battery on page 35](#)).
6. Remove the system board (see [System board on page 49](#)).

Remove the touchpad button board:

1. Disconnect the cable from the touchpad to the smart card reader board **(1)**, and then disconnect the NFC antenna from the NFC module **(2)**.
2. Lift the tape, and then remove the 3 Phillips PM2.5x3.0 screws **(3)** that secure the touchpad button board to the top cover.
3. Lift the bottom of the touchpad button board up, and then pull it forward to remove it from the slot **(4)**.

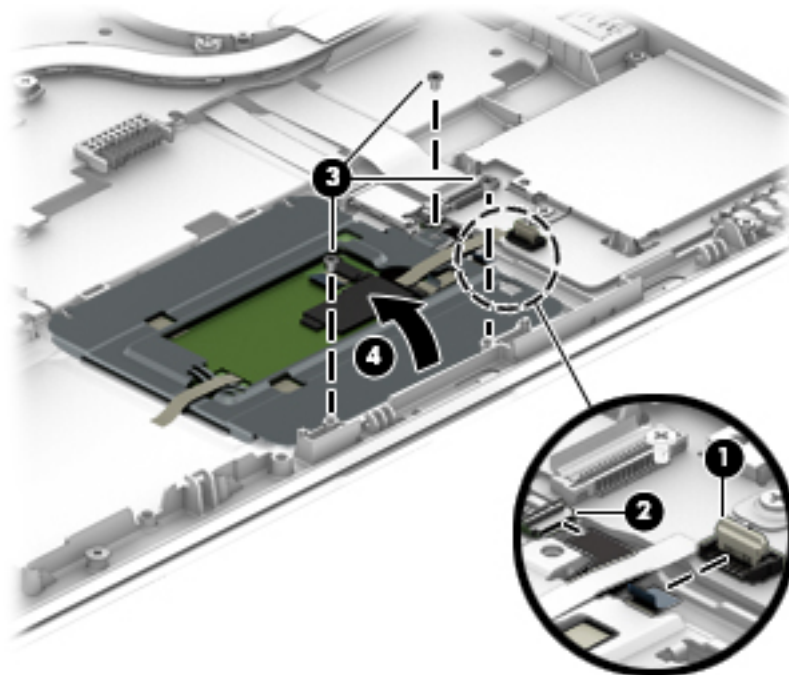

Reverse this procedure to install the touchpad board.

NFC module

Description	Spare part number
NFC (Near Field Communication) module	821666-001

Before removing the NFC module, follow these steps:

1. Turn off the computer. If you are unsure whether the computer is off or in Hibernation, turn the computer on, and then shut it down through the operating system.
2. Disconnect the power from the computer by unplugging the power cord from the computer.
3. Disconnect all external devices from the computer.
4. Remove the bottom cover (see [Bottom cover on page 32](#)).
5. Remove the battery (see [Battery on page 35](#)).
6. Remove the system board (see [System board on page 49](#)).

Remove the NFC module:

1. Disconnect the system board cable (1) and the NFC antenna from the NFC module.
2. Pry the NFC module from the smart card reader, and then lift it from the computer (2).

 **NOTE:** The NFC antenna is spared with the touchpad.

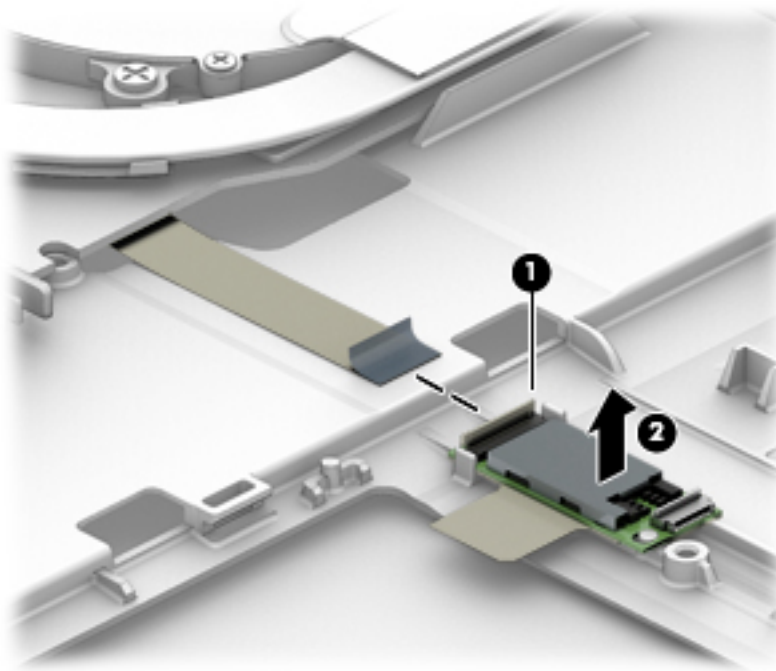

Reverse the removal procedures to install the NFC module.

Smart card reader board

Description	Spare part number
Smart card reader board (includes cable)	821695-001

Before removing the card reader board, follow these steps:

1. Shut down the computer. If you are unsure whether the computer is off or in Hibernation, turn the computer on, and then shut it down through the operating system.
2. Disconnect all external devices connected to the computer.
3. Disconnect the power from the computer by first unplugging the power cord from the AC outlet, and then unplugging the AC adapter from the computer.
4. Remove the bottom cover (see [Bottom cover on page 32](#)).
5. Remove the battery (see [Battery on page 35](#)).
6. Remove the system board (see [System board on page 49](#)).

Remove the smart card reader board:



NOTE: Before you remove the smart card reader, make sure nothing (memory card or plastic insert) is installed.

1. Disconnect the cable from the board **(1)**.
2. Disconnect the cable from the touchpad **(2)**.
3. Remove the 3 Phillips PM2.5x3.0 screws that secure the bracket to the top cover **(3)**, and then lift to remove it from the computer **(4)**.

4. Lift the smart card reader board left to remove it from the top cover **(5)**.

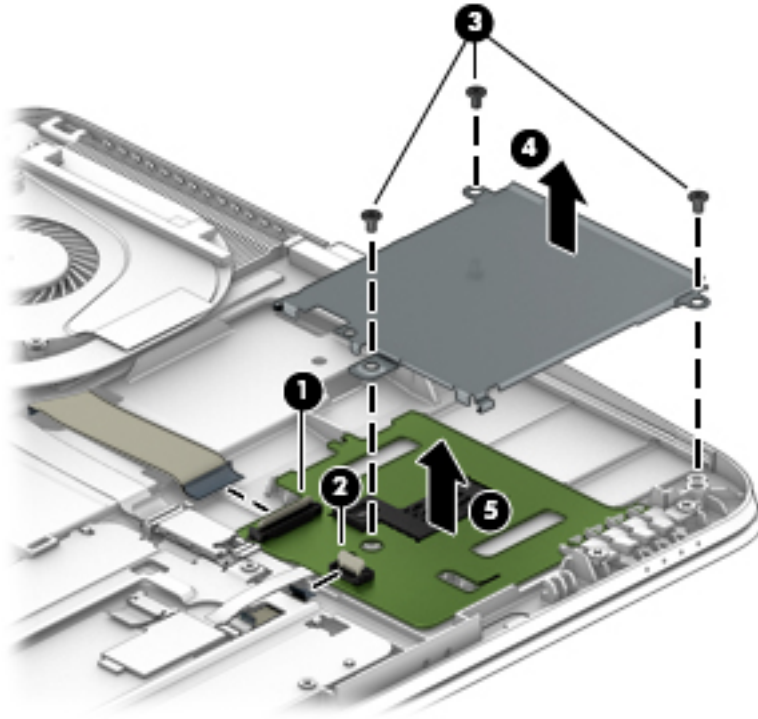

Reverse this procedure to install the card reader board.

Speaker assembly

Description	Spare part number
Speaker assembly (includes cable)	821684-001

Before removing the speaker assembly, follow these steps:

1. Turn off the computer. If you are unsure whether the computer is off or in Hibernation, turn the computer on, and then shut it down through the operating system.
2. Disconnect the power from the computer by unplugging the power cord from the computer.
3. Disconnect all external devices from the computer.
4. Remove the bottom cover (see [Bottom cover on page 32](#)).
5. Remove the battery (see [Battery on page 35](#)).
6. Remove the system board (see [System board on page 49](#)).

Remove the speaker assembly:

1. Remove the two Phillips PM2.5x3.0 screws that secure the speakers to the computer **(1)**.

2. Remove the speaker **(2)** from the computer.

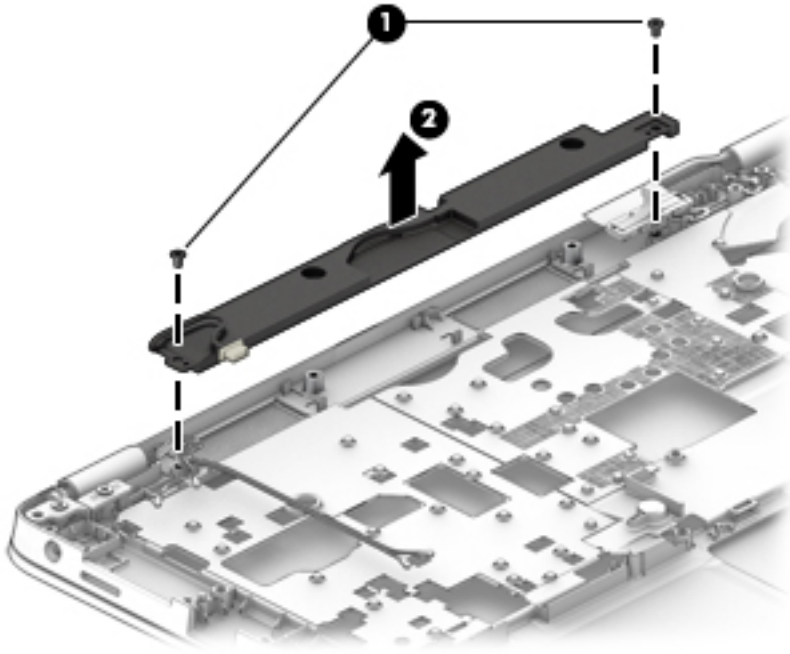

Reverse this procedure to install the speakers.

Display assembly

Description	Spare part number
Display panel assembly, touch screen	821657-001

Before removing the display assembly, follow these steps:

1. Shut down the computer. If you are unsure whether the computer is off or in Hibernation, turn the computer on, and then shut it down through the operating system.
2. Disconnect all external devices connected to the computer.
3. Disconnect the power from the computer by first unplugging the power cord from the AC outlet, and then unplugging the AC adapter from the computer.
4. Remove the bottom cover (see [Bottom cover on page 32](#)).
5. Remove the battery (see [Battery on page 35](#)).

Remove the display assembly:

1. Position the computer upside down.
2. Disconnect the display cable from the system board.

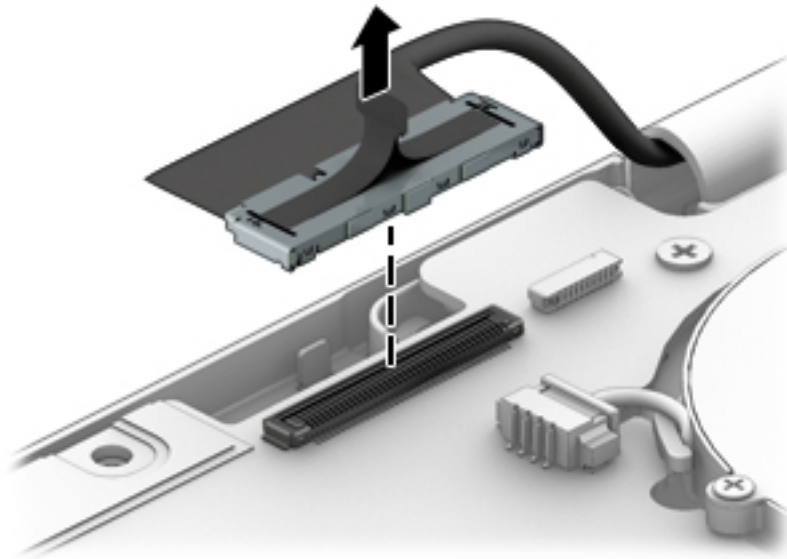

3. Remove the WWAN antennas (1) and WLAN antennas (2) (if equipped) from the routing path along the base of the computer.

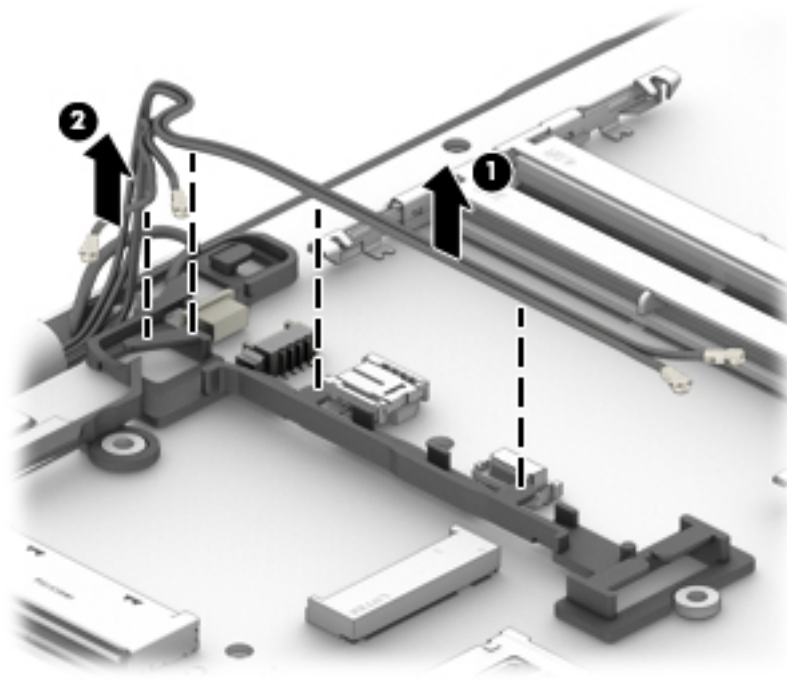

4. Remove the 4 Phillips PM2.5×5.0 screws (1) from the display hinges.

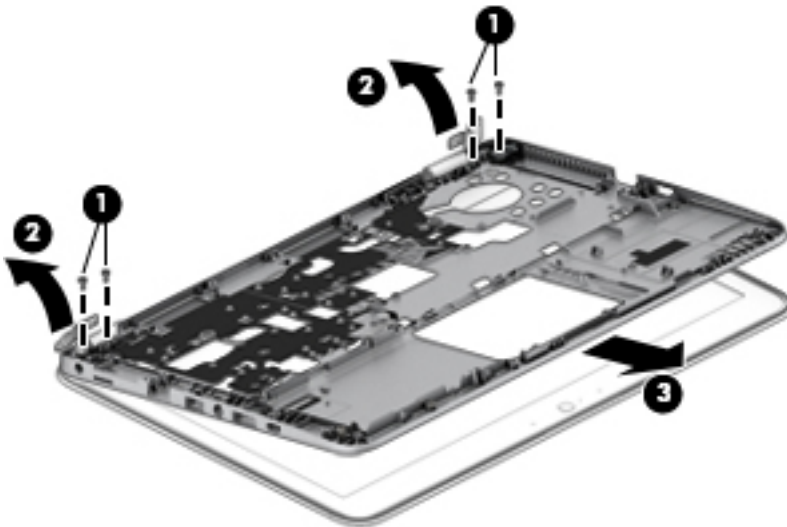

5. Lift the hinges (2) up and remove the top cover from the display assembly (3).

CAUTION: When installing the display assembly, be sure that the wireless antenna cables are routed and arranged properly.

Failure to properly route the antennas can result in degradation of the computer's wireless performance.

6. If you need to remove the display bezel, flex the top (1) of the bezel, the inside edges of the left and right sides (2), and then the bottom (3) of the bezel until it disengages from the display enclosure.

NOTE: Make sure the hinges are not bent (see hinge position in following image) when you remove the bezel.

7. Remove the display bezel (4).

The display bezel is available using spare part number 821658-001.

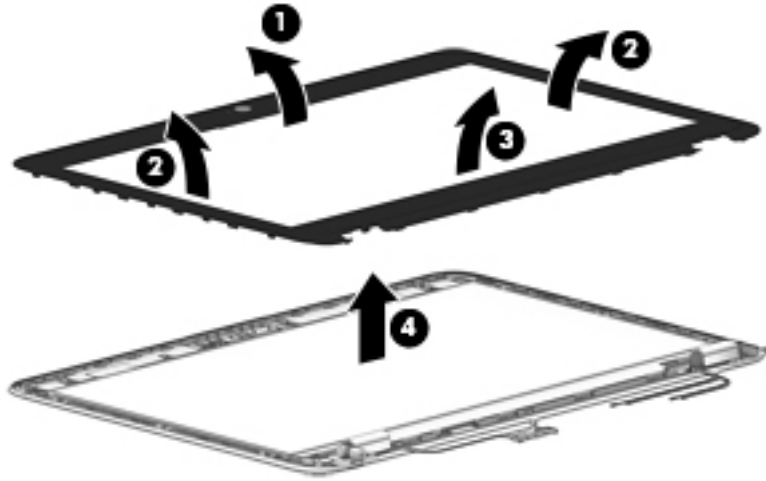

8. If it is necessary to replace the webcam or microphone module, gently pull the module away from the double-sided tape on the display enclosure (1), and then disconnect the cable from the module (2).

The webcam module is available using spare part number 821676-001. The microphone module is available using spare part number 821696-001.

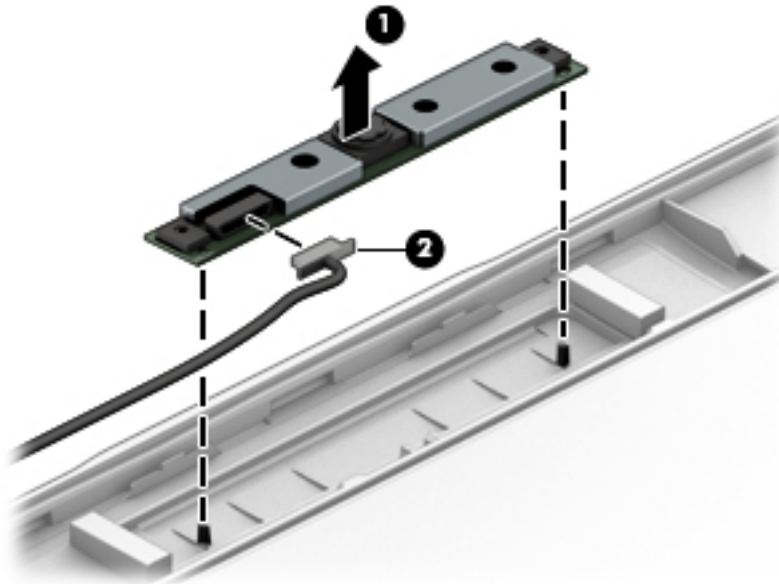

9. If it is necessary to remove the display panel from the enclosure, remove the 4 Phillips PM2.0×3.0 screws that secure the panel to the display enclosure, and then lift the top of the panel upward.

The raw display panel is available using spare part number 821655-001 for HD panels and 821656-001 for FHD panels.

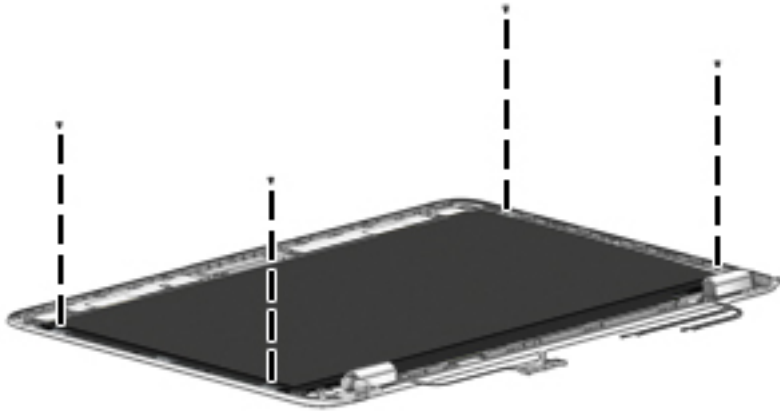

10. Rotate the display panel all the way over (1), disconnect the display cable from the rear of the panel (2), and then remove the display panel from the enclosure.

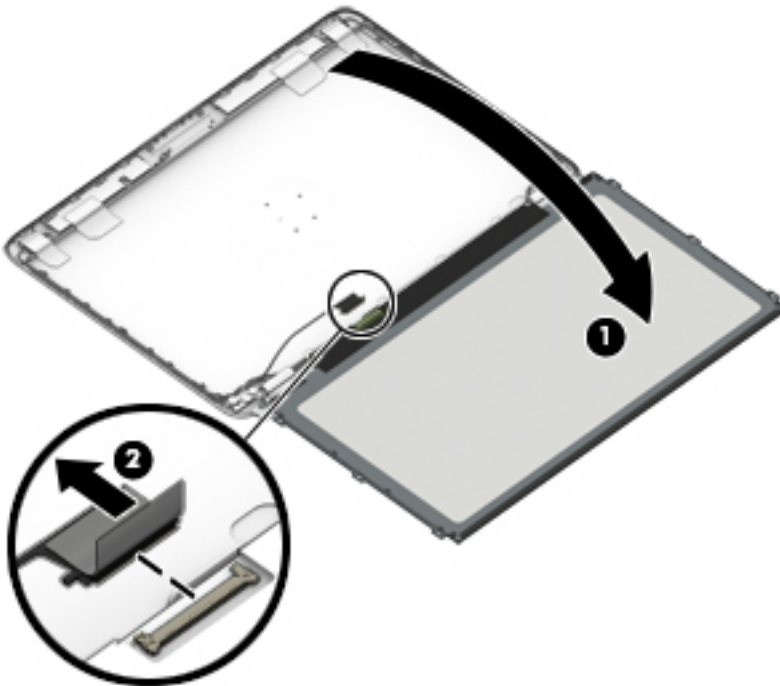

11. If it is necessary to replace the display hinges, remove the 1 Phillips PM2.0×3.0 screw (1) that secure the hinge covers to the display enclosure, and then remove the hinge covers (2).

12. Remove the 6 Phillips PM2.5x2.5 screws that secure the hinges to the display enclosure (3), and then remove the display hinges from the display enclosure (4).

Display hinges are available in the Display Hinge Kit using spare part number 821674-001.

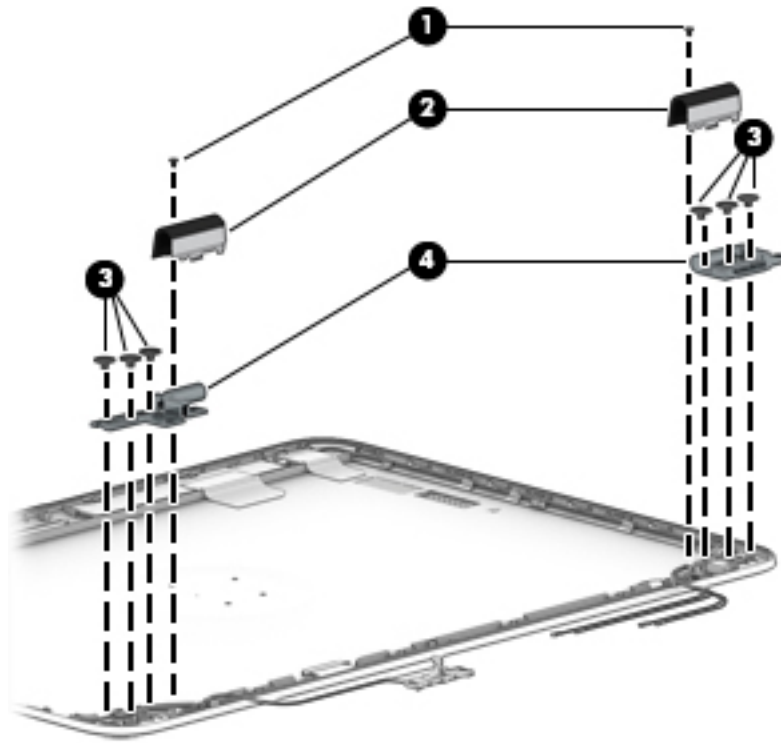

13. If it is necessary to replace the display/webcam cable, remove the display/webcam cable assembly from the routing (1) and then lift it from the computer (2).

The display cable is available in the Cable Kit using spare part number 821669-001.

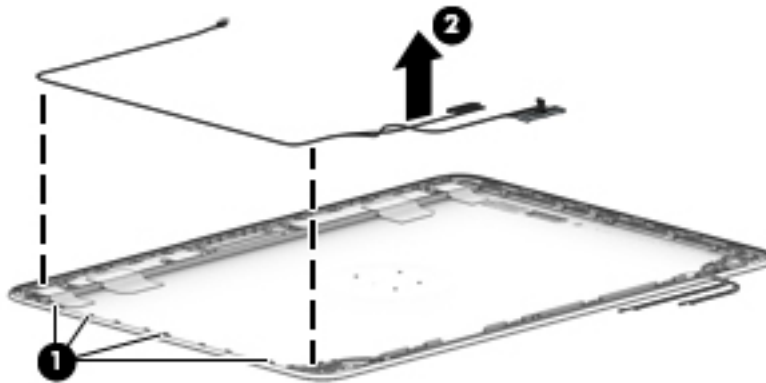

Reverse this procedure to reassemble and install the display assembly.

Top cover

Description	Spare part number
Top cover	821692-001

Before removing the top cover, follow these steps:

1. Shut down the computer. If you are unsure whether the computer is off or in Hibernation, turn the computer on, and then shut it down through the operating system.
2. Disconnect all external devices connected to the computer.
3. Disconnect the power from the computer by first unplugging the power cord from the AC outlet, and then unplugging the AC adapter from the computer.
4. Remove all other components.

Reverse this procedure to install the top cover.

7 Computer Setup (BIOS), TPM, and HP Sure Start in Windows 10

Using Computer Setup

Computer Setup, or Basic Input/Output System (BIOS), controls communication between all the input and output devices on the system (such as disk drives, display, keyboard, mouse, and printer). Computer Setup includes settings for the types of devices installed, the startup sequence of the computer, and the amount of system and extended memory.

 **NOTE:** Use extreme care when making changes in Computer Setup. Errors can prevent the computer from operating properly.

Starting Computer Setup

 **NOTE:** An external keyboard or mouse connected to a USB port can be used with Computer Setup only if USB legacy support is enabled.

To start Computer Setup, follow these steps:

- ▲ Start Computer Setup.
 - Computers or tablets with keyboards:
 - ▲ Turn on or restart the computer, and when the HP logo appears, press **F10** to enter Computer Setup.
 - Tablets without keyboards:
 - ▲ Turn off the tablet. Press the power button in combination with the volume down button until the Startup menu is displayed, and then tap **F10** to enter Computer Setup.

Navigating and selecting in Computer Setup

- To select a menu or a menu item, use the **tab** key and the keyboard arrow keys and then press **enter**, or use a pointing device to select the item.

 **NOTE:** On tablets without keyboards, you can use your finger to make selections.

- To scroll up and down, select the up arrow or the down arrow in the upper-right corner of the screen, or use the up arrow key or the down arrow key on the keyboard.
- To close open dialog boxes and return to the main Computer Setup screen, press **esc**, and then follow the on-screen instructions.

To exit Computer Setup menus, choose one of the following methods:

- To exit Computer Setup menus without saving your changes:
Select the **Exit** icon in the lower-right corner of the screen, and then follow the on-screen instructions.
– or –
Select **Main**, select **Ignore Changes and Exit**, and then press [enter](#).
- To save your changes and exit Computer Setup menus:
Select the **Save** icon in the lower-right corner of the screen, and then follow the on-screen instructions.
– or –
Select **Main**, select **Save Changes and Exit**, and then press [enter](#).

Your changes go into effect when the computer restarts.

Restoring factory settings in Computer Setup

 **NOTE:** Restoring defaults will not change the hard drive mode.

To return all settings in Computer Setup to the values that were set at the factory, follow these steps:

1. Start Computer Setup. See [Starting Computer Setup on page 67](#).
2. Select **Main**, and then select **Apply Factory Defaults and Exit**.

 **NOTE:** On select products, the selections may display **Restore Defaults** instead of **Apply Factory Defaults and Exit**.

3. Follow the on-screen instructions.
4. To save your changes and exit, select the **Save** icon in the lower-right corner of the screen, and then follow the on-screen instructions.
– or –
Select **Main**, select **Save Changes and Exit**, and then press [enter](#).

Your changes go into effect when the computer restarts.

 **NOTE:** Your password settings and security settings are not changed when you restore the factory settings.

Updating the BIOS

Updated versions of the BIOS may be available on the HP website.

Most BIOS updates on the HP website are packaged in compressed files called *SoftPaqs*.

Some download packages contain a file named *Readme.txt*, which contains information regarding installing and troubleshooting the file.

Determining the BIOS version

To decide whether you need to update Computer Setup (BIOS), first determine the BIOS version on your computer.

BIOS version information (also known as *ROM date* and *System BIOS*) can be accessed by pressing **fn+esc** (if you are already in Windows) or by using Computer Setup.

1. Start Computer Setup. See [Starting Computer Setup on page 67](#).
2. Select **Main**, and then select **System Information**.
3. To exit Computer Setup without saving your changes, select the **Exit** icon in the lower-right corner of the screen, and then follow the on-screen instructions.

– or –

Select **Main**, select **Ignore Changes and Exit**, and then press **enter**.

To check for later BIOS versions, see [Downloading a BIOS update on page 69](#).

Downloading a BIOS update

 **CAUTION:** To reduce the risk of damage to the computer or an unsuccessful installation, download and install a BIOS update only when the computer is connected to reliable external power using the AC adapter. Do not download or install a BIOS update while the computer is running on battery power, docked in an optional docking device, or connected to an optional power source. During the download and installation, follow these instructions:

Do not disconnect power on the computer by unplugging the power cord from the AC outlet.

Do not shut down the computer or initiate Sleep.

Do not insert, remove, connect, or disconnect any device, cable, or cord.

1. Type `support` in the taskbar search box, and then select the HP Support Assistant app.
– or –
Select the question mark icon in the taskbar.
2. Select **Updates**, and then select **Check for updates and messages**.
3. Follow the on-screen instructions.
4. At the download area, follow these steps:
 - a. Identify the most recent BIOS update and compare it to the BIOS version currently installed on your computer. Make a note of the date, name, or other identifier. You may need this information to locate the update later, after it has been downloaded to your hard drive.
 - b. Follow the on-screen instructions to download your selection to the hard drive.
Make a note of the path to the location on your hard drive where the BIOS update is downloaded. You will need to access this path when you are ready to install the update.

 **NOTE:** If you connect your computer to a network, consult the network administrator before installing any software updates, especially system BIOS updates.

BIOS installation procedures vary. Follow any instructions that are revealed on the screen after the download is complete. If no instructions are revealed, follow these steps:

1. Type `file` in the taskbar search box, and then select **File Explorer**.
2. Select your hard drive designation. The hard drive designation is typically Local Disk (C:).
3. Using the hard drive path you recorded earlier, open the folder that contains the update.
4. Double-click the file that has an `.exe` extension (for example, `filename.exe`).
The BIOS installation begins.
5. Complete the installation by following the on-screen instructions.

 **NOTE:** After a message on the screen reports a successful installation, you can delete the downloaded file from your hard drive.

Changing the boot order using the f9 prompt

To dynamically choose a boot device for the current startup sequence, follow these steps:

1. Access the Boot Device Options menu:
 - Computers or tablets with keyboards:
 - ▲ Turn on or restart the computer, and when the HP logo appears, press **f9** to enter the Boot Device Options menu.
 - Tablets without keyboards:
 - ▲ Turn off the tablet. Press the power button in combination with the volume down button until the Startup menu is displayed, and then tap **F9** to enter the Boot Device Options menu.
2. Select a boot device, then press `enter`.

TPM BIOS settings (select products only)

 **IMPORTANT:** Before enabling Trusted Platform Module (TPM) functionality on this system, you must ensure that your intended use of TPM complies with relevant local laws, regulations and policies, and approvals or licenses must be obtained if applicable. For any compliance issues arising from your operation/usage of TPM which violates the above mentioned requirement, you shall bear all the liabilities wholly and solely. HP will not be responsible for any related liabilities.

TPM provides additional security for your computer. You can modify the TPM settings in Computer Setup (BIOS).

 **NOTE:** If you change the TPM setting to Hidden, TPM is not visible in the operating system.

To access TPM settings in Computer Setup:

1. Start Computer Setup. See [Starting Computer Setup on page 67](#).
2. Select **Security**, select **TPM Embedded Security**, and then follow the on-screen instructions.

Using HP Sure Start (select products only)

Select computer models are configured with HP Sure Start, a technology that continuously monitors the computer's BIOS for attacks or corruption. If the BIOS becomes corrupted or is attacked, HP Sure Start automatically restores the BIOS to its previously safe state, without user intervention.

HP Sure Start is configured and already enabled so that most users can use the HP Sure Start default configuration. The default configuration can be customized by advanced users.

To access the latest documentation on HP Sure Start, go to <http://www.hp.com/support>, and select your country. Select **Drivers & Downloads**, and then follow the on-screen instructions.

8 Computer Setup (BIOS), TPM, and HP Sure Start in Windows 8

Using Computer Setup

Computer Setup, or Basic Input/Output System (BIOS), controls communication between all the input and output devices on the system (such as disk drives, display, keyboard, mouse, and printer). Computer Setup includes settings for the types of devices installed, the startup sequence of the computer, and the amount of system and extended memory.

 **NOTE:** Use extreme care when making changes in Computer Setup. Errors can prevent the computer from operating properly.

Starting Computer Setup

 **NOTE:** An external keyboard or mouse connected to a USB port can be used with Computer Setup only if USB legacy support is enabled.

To start Computer Setup, follow these steps:

- ▲ Start Computer Setup.
 - Computers or tablets with keyboards:
 - ▲ Turn on or restart the computer, and when the HP logo appears, press **F10** to enter Computer Setup.
 - Tablets without keyboards:
 - ▲ Turn off the tablet. Press the power button in combination with the volume down button until the Startup menu is displayed, and then tap **F10** to enter Computer Setup.

Navigating and selecting in Computer Setup

- To select a menu or a menu item, use the **tab** key and the keyboard arrow keys and then press **enter**, or use a pointing device to select the item.

 **NOTE:** On tablets without keyboards, you can use your finger to make selections.

- To scroll up and down, select the up arrow or the down arrow in the upper-right corner of the screen, or use the up arrow key or the down arrow key on the keyboard.
- To close open dialog boxes and return to the main Computer Setup screen, press **esc**, and then follow the on-screen instructions.

To exit Computer Setup menus, choose one of the following methods:

- To exit Computer Setup menus without saving your changes:
Select the **Exit** icon in the lower-right corner of the screen, and then follow the on-screen instructions.
– or –
Select **Main**, select **Ignore Changes and Exit**, and then press [enter](#).
- To save your changes and exit Computer Setup menus:
Select the **Save** icon in the lower-right corner of the screen, and then follow the on-screen instructions.
– or –
Select **Main**, select **Save Changes and Exit**, and then press [enter](#).

Your changes go into effect when the computer restarts.

Restoring factory settings in Computer Setup

 **NOTE:** Restoring defaults will not change the hard drive mode.

To return all settings in Computer Setup to the values that were set at the factory, follow these steps:

1. Start Computer Setup. See [Starting Computer Setup on page 72](#).
2. Select **Main**, and then select **Apply Factory Defaults and Exit**.

 **NOTE:** On select products, the selections may display **Restore Defaults** instead of **Apply Factory Defaults and Exit**.

3. Follow the on-screen instructions.
4. To save your changes and exit, select the **Save** icon in the lower-right corner of the screen, and then follow the on-screen instructions.
– or –
Select **Main**, select **Save Changes and Exit**, and then press [enter](#).

Your changes go into effect when the computer restarts.

 **NOTE:** Your password settings and security settings are not changed when you restore the factory settings.

Updating the BIOS

Updated versions of the BIOS may be available on the HP website.

Most BIOS updates on the HP website are packaged in compressed files called *SoftPaqs*.

Some download packages contain a file named *Readme.txt*, which contains information regarding installing and troubleshooting the file.

Determining the BIOS version

To decide whether you need to update Computer Setup (BIOS), first determine the BIOS version on your computer.

BIOS version information (also known as *ROM date* and *System BIOS*) can be accessed by pressing **fn+esc** (if you are already in Windows) or by using Computer Setup.

1. Start Computer Setup. See [Starting Computer Setup on page 72](#).
2. Select **Main**, and then select **System Information**.
3. To exit Computer Setup without saving your changes, select the **Exit** icon in the lower-right corner of the screen, and then follow the on-screen instructions.

– or –

Select **Main**, select **Ignore Changes and Exit**, and then press **enter**.

To check for later BIOS versions, see [Downloading a BIOS update on page 74](#).

Downloading a BIOS update

 **CAUTION:** To reduce the risk of damage to the computer or an unsuccessful installation, download and install a BIOS update only when the computer is connected to reliable external power using the AC adapter. Do not download or install a BIOS update while the computer is running on battery power, docked in an optional docking device, or connected to an optional power source. During the download and installation, follow these instructions:

Do not disconnect power on the computer by unplugging the power cord from the AC outlet.

Do not shut down the computer or initiate Sleep.

Do not insert, remove, connect, or disconnect any device, cable, or cord.

1. From the Start screen, type `support`, and then select the **HP Support Assistant** app.
2. Select **Updates**, and then select **Check for updates and messages**.
3. Follow the on-screen instructions.
4. At the download area, follow these steps:
 - a. Identify the most recent BIOS update and compare it to the BIOS version currently installed on your computer. Make a note of the date, name, or other identifier. You may need this information to locate the update later, after it has been downloaded to your hard drive.
 - b. Follow the on-screen instructions to download your selection to the hard drive.

Make a note of the path to the location on your hard drive where the BIOS update is downloaded. You will need to access this path when you are ready to install the update.

 **NOTE:** If you connect your computer to a network, consult the network administrator before installing any software updates, especially system BIOS updates.

BIOS installation procedures vary. Follow any instructions that are revealed on the screen after the download is complete. If no instructions are revealed, follow these steps:

1. From the Start screen, type *file*, and then select **File Explorer**.
2. Select your hard drive designation. The hard drive designation is typically Local Disk (C:).
3. Using the hard drive path you recorded earlier, open the folder that contains the update.
4. Double-click the file that has an .exe extension (for example, *filename.exe*).
The BIOS installation begins.
5. Complete the installation by following the on-screen instructions.

 **NOTE:** After a message on the screen reports a successful installation, you can delete the downloaded file from your hard drive.

Changing the boot order using the f9 prompt

To dynamically choose a boot device for the current startup sequence, follow these steps:

1. Access the Boot Device Options menu:
 - Computers or tablets with keyboards:
 - ▲ Turn on or restart the computer, and when the HP logo appears, press **f9** to enter the Boot Device Options menu.
 - Tablets without keyboards:
 - ▲ Turn off the tablet. Press the power button in combination with the volume down button until the Startup menu is displayed, and then tap **F9** to enter the Boot Device Options menu.
2. Select a boot device, then press **enter**.

TPM BIOS settings (select products only)

 **IMPORTANT:** Before enabling Trusted Platform Module (TPM) functionality on this system, you must ensure that your intended use of TPM complies with relevant local laws, regulations and policies, and approvals or licenses must be obtained if applicable. For any compliance issues arising from your operation/usage of TPM which violates the above mentioned requirement, you shall bear all the liabilities wholly and solely. HP will not be responsible for any related liabilities.

TPM provides additional security for your computer. You can modify the TPM settings in Computer Setup (BIOS).

 **NOTE:** If you change the TPM setting to Hidden, TPM is not visible in the operating system.

To access TPM settings in Computer Setup:

1. Start Computer Setup. See [Starting Computer Setup on page 72](#).
2. Select **Security**, select **TPM Embedded Security**, and then follow the on-screen instructions.

Using HP Sure Start (select products only)

Select computer models are configured with HP Sure Start, a technology that continuously monitors the computer's BIOS for attacks or corruption. If the BIOS becomes corrupted or is attacked, HP Sure Start automatically restores the BIOS to its previously safe state, without user intervention.

HP Sure Start is configured and already enabled so that most users can use the HP Sure Start default configuration. The default configuration can be customized by advanced users.

To access the latest documentation on HP Sure Start, go to <http://www.hp.com/support>, and select your country. Select **Drivers & Downloads**, and then follow the on-screen instructions.

9 Computer Setup (BIOS), TPM, and HP Sure Start in Windows 7

Using Computer Setup

Computer Setup, or Basic Input/Output System (BIOS), controls communication between all the input and output devices on the system (such as disk drives, display, keyboard, mouse, and printer). Computer Setup includes settings for the types of devices installed, the startup sequence of the computer, and the amount of system and extended memory.

 **NOTE:** Use extreme care when making changes in Computer Setup. Errors can prevent the computer from operating properly.

Starting Computer Setup

 **NOTE:** An external keyboard or mouse connected to a USB port can be used with Computer Setup only if USB legacy support is enabled.

To start Computer Setup, follow these steps:

- ▲ Start Computer Setup.
 - Computers or tablets with keyboards:
 - ▲ Turn on or restart the computer, and when the HP logo appears, press **F10** to enter Computer Setup.
 - Tablets without keyboards:
 - ▲ Turn off the tablet. Press the power button in combination with the volume down button until the Startup menu is displayed, and then tap **F10** to enter Computer Setup.

Navigating and selecting in Computer Setup

- To select a menu or a menu item, use the **tab** key and the keyboard arrow keys and then press **enter**, or use a pointing device to select the item.

 **NOTE:** On tablets without keyboards, you can use your finger to make selections.

- To scroll up and down, select the up arrow or the down arrow in the upper-right corner of the screen, or use the up arrow key or the down arrow key on the keyboard.
- To close open dialog boxes and return to the main Computer Setup screen, press **esc**, and then follow the on-screen instructions.

To exit Computer Setup menus, choose one of the following methods:

- To exit Computer Setup menus without saving your changes:
Select the **Exit** icon in the lower-right corner of the screen, and then follow the on-screen instructions.
– or –
Select **Main**, select **Ignore Changes and Exit**, and then press [enter](#).
- To save your changes and exit Computer Setup menus:
Select the **Save** icon in the lower-right corner of the screen, and then follow the on-screen instructions.
– or –
Select **Main**, select **Save Changes and Exit**, and then press [enter](#).

Your changes go into effect when the computer restarts.

Restoring factory settings in Computer Setup

 **NOTE:** Restoring defaults will not change the hard drive mode.

To return all settings in Computer Setup to the values that were set at the factory, follow these steps:

1. Start Computer Setup. See [Starting Computer Setup on page 77](#).
2. Select **Main**, and then select **Apply Factory Defaults and Exit**.

 **NOTE:** On select products, the selections may display **Restore Defaults** instead of **Apply Factory Defaults and Exit**.

3. Follow the on-screen instructions.
4. To save your changes and exit, select the **Save** icon in the lower-right corner of the screen, and then follow the on-screen instructions.
– or –
Select **Main**, select **Save Changes and Exit**, and then press [enter](#).

Your changes go into effect when the computer restarts.

 **NOTE:** Your password settings and security settings are not changed when you restore the factory settings.

Updating the BIOS

Updated versions of the BIOS may be available on the HP website.

Most BIOS updates on the HP website are packaged in compressed files called *SoftPaqs*.

Some download packages contain a file named *Readme.txt*, which contains information regarding installing and troubleshooting the file.

Determining the BIOS version

To decide whether you need to update Computer Setup (BIOS), first determine the BIOS version on your computer.

BIOS version information (also known as *ROM date* and *System BIOS*) can be accessed by pressing **fn+esc** (if you are already in Windows) or by using Computer Setup.

1. Start Computer Setup. See [Starting Computer Setup on page 77](#).
2. Select **Main**, and then select **System Information**.
3. To exit Computer Setup without saving your changes, select the **Exit** icon in the lower-right corner of the screen, and then follow the on-screen instructions.

– or –

Select **Main**, select **Ignore Changes and Exit**, and then press **enter**.

To check for later BIOS versions, see [Downloading a BIOS update on page 79](#).

Downloading a BIOS update

 **CAUTION:** To reduce the risk of damage to the computer or an unsuccessful installation, download and install a BIOS update only when the computer is connected to reliable external power using the AC adapter. Do not download or install a BIOS update while the computer is running on battery power, docked in an optional docking device, or connected to an optional power source. During the download and installation, follow these instructions:

Do not disconnect power on the computer by unplugging the power cord from the AC outlet.

Do not shut down the computer or initiate Sleep.

Do not insert, remove, connect, or disconnect any device, cable, or cord.

1. Access Help and Support by selecting **Start > All Programs > HP Help and Support > HP Support Assistant**.
2. Select **Updates**, and then select **Check for updates and messages**.
3. Follow the on-screen instructions.
4. At the download area, follow these steps:
 - a. Identify the most recent BIOS update and compare it to the BIOS version currently installed on your computer. Make a note of the date, name, or other identifier. You may need this information to locate the update later, after it has been downloaded to your hard drive.
 - b. Follow the on-screen instructions to download your selection to the hard drive.

Make a note of the path to the location on your hard drive where the BIOS update is downloaded. You will need to access this path when you are ready to install the update.

 **NOTE:** If you connect your computer to a network, consult the network administrator before installing any software updates, especially system BIOS updates.

BIOS installation procedures vary. Follow any instructions that are revealed on the screen after the download is complete. If no instructions are revealed, follow these steps:

1. Select **Start > Computer**.
2. Select your hard drive designation. The hard drive designation is typically Local Disk (C:).
3. Using the hard drive path you recorded earlier, open the folder that contains the update.
4. Double-click the file that has an .exe extension (for example, *filename.exe*).
The BIOS installation begins.
5. Complete the installation by following the on-screen instructions.

 **NOTE:** After a message on the screen reports a successful installation, you can delete the downloaded file from your hard drive.

Changing the boot order using the f9 prompt

To dynamically choose a boot device for the current startup sequence, follow these steps:

1. Access the Boot Device Options menu:
 - Computers or tablets with keyboards:
 - ▲ Turn on or restart the computer, and when the HP logo appears, press **f9** to enter the Boot Device Options menu.
 - Tablets without keyboards:
 - ▲ Turn off the tablet. Press the power button in combination with the volume down button until the Startup menu is displayed, and then tap **F9** to enter the Boot Device Options menu.
2. Select a boot device, then press [enter](#).

TPM BIOS settings (select products only)

 **IMPORTANT:** Before enabling Trusted Platform Module (TPM) functionality on this system, you must ensure that your intended use of TPM complies with relevant local laws, regulations and policies, and approvals or licenses must be obtained if applicable. For any compliance issues arising from your operation/usage of TPM which violates the above mentioned requirement, you shall bear all the liabilities wholly and solely. HP will not be responsible for any related liabilities.

TPM provides additional security for your computer. You can modify the TPM settings in Computer Setup (BIOS).

 **NOTE:** If you change the TPM setting to Hidden, TPM is not visible in the operating system.

To access TPM settings in Computer Setup:

1. Start Computer Setup. See [Starting Computer Setup on page 77](#).
2. Select **Security**, select **TPM Embedded Security**, and then follow the on-screen instructions.

Using HP Sure Start (select products only)

Select computer models are configured with HP Sure Start, a technology that continuously monitors the computer's BIOS for attacks or corruption. If the BIOS becomes corrupted or is attacked, HP Sure Start automatically restores the BIOS to its previously safe state, without user intervention.

HP Sure Start is configured and already enabled so that most users can use the HP Sure Start default configuration. The default configuration can be customized by advanced users.

To access the latest documentation on HP Sure Start, go to <http://www.hp.com/support>, and select your country. Select **Drivers & Downloads**, and then follow the on-screen instructions.

10 HP PC Hardware Diagnostics (UEFI)

HP PC Hardware Diagnostics is a Unified Extensible Firmware Interface (UEFI) that allows you to run diagnostic tests to determine whether the computer hardware is functioning properly. The tool runs outside the operating system so that it can isolate hardware failures from issues that are caused by the operating system or other software components.

When HP PC Hardware Diagnostics (UEFI) detects a failure that requires hardware replacement, a 24-digit Failure ID is generated. This ID can then be provided to support to help determine how to correct the problem.

 **NOTE:** To start diagnostics on a convertible computer, your computer must be in notebook mode and you must use the keyboard attached.

To start HP PC Hardware Diagnostics (UEFI), follow these steps:

1. Turn on or restart the computer, quickly press **esc**.

 **NOTE:** The HP PC Hardware Diagnostics (UEFI) download instructions are provided in English only, and you must use a Windows computer to download and create the HP UEFI support environment because only .exe files are offered.

2. Press or tap **f2**.

The BIOS searches three places for the diagnostic tools, in the following order:

- a. Connected USB drive

 **NOTE:** To download the HP PC Hardware Diagnostics (UEFI) tool to a USB drive, see [Downloading HP PC Hardware Diagnostics \(UEFI\) to a USB device on page 82](#).

- b. Hard drive

- c. BIOS

3. When the diagnostic tool opens, select the type of diagnostic test you want to run, and then follow the on-screen instructions.

 **NOTE:** If you need to stop a diagnostic test, press **esc**.

Downloading HP PC Hardware Diagnostics (UEFI) to a USB device

 **NOTE:** The HP PC Hardware Diagnostics (UEFI) download instructions are provided in English only, and you must use a Windows computer to download and create the HP UEFI support environment because only .exe files are offered.

There are two options to download HP PC Hardware Diagnostics to a USB device.

Download the latest UEFI version

1. Go to <http://www.hp.com/go/techcenter/pcdiags>. The HP PC Diagnostics home page is displayed.
2. In the HP PC Hardware Diagnostics section, click the **Download** link, and then select **Run**.

Download any version of UEFI for a specific product

1. Go to <http://www.hp.com/support>, and then select your country. The HP Support page is displayed.
2. Click **Drivers & Downloads**.
3. In the text box, enter the product name, and then click **Go**.
– or –
Click **Find Now** to let HP automatically detect your product.
4. Select your computer, and then select your operating system.
5. In the **Diagnostic** section, follow the on-screen instructions to select and download the UEFI version you want.

11 Backing up and recovering Windows 10

This chapter provides information about the following processes. The information in the chapter is standard procedure for most products.

- Creating recovery media and backups
- Restoring and recovering your system

For additional information, refer to the HP support assistant app.

▲ Type `support` in the taskbar search box, and then select the **HP Support Assistant** app.

– or –

Click the question mark icon in the taskbar.

 **IMPORTANT:** If you will be performing recovery procedures on a tablet, the tablet battery must be at least 70% charged before you start the recovery process.

IMPORTANT: For a tablet with a detachable keyboard, connect the keyboard to the keyboard dock before beginning any recovery process.

Creating recovery media and backups

The following methods of creating recovery media and backups are available on select products only. Choose the available method according to your computer model.

- Use HP Recovery Manager to create HP Recovery media after you successfully set up the computer. This step creates a backup of the HP Recovery partition on the computer. The backup can be used to reinstall the original operating system in cases where the hard drive is corrupted or has been replaced. For information on creating recovery media, see [Creating HP Recovery media \(select products only\) on page 84](#). For information on the recovery options that are available using the recovery media, see [Using Windows tools on page 85](#).
- Use Windows tools to create system restore points and create backups of personal information.

For more information, see [Recovering using HP Recovery Manager on page 86](#).

 **NOTE:** If storage is 32 GB or less, Microsoft System Restore is disabled by default.

Creating HP Recovery media (select products only)

If possible, check for the presence of the Recovery partition and the Windows partition. From the **Start** menu, select **File Explorer**, and then select **This PC**.

- If your computer does not list the Windows partition and the Recovery partition, you can obtain recovery media for your system from support. See the *Worldwide Telephone Numbers* booklet included with the computer. You can also find contact information on the HP website. Go to <http://www.hp.com/support>, select your country or region, and follow the on-screen instructions.

You can use Windows tools to create system restore points and create backups of personal information, see [Using Windows tools on page 85](#).

- If your computer does list the Recovery partition and the Windows partition, you can use HP Recovery Manager to create recovery media after you successfully set up the computer. HP Recovery media can be used to perform system recovery if the hard drive becomes corrupted. System recovery reinstalls the original operating system and software programs that were installed at the factory and then configures the settings for the programs. HP Recovery media can also be used to customize the system or restore the factory image if you replace the hard drive.
 - Only one set of recovery media can be created. Handle these recovery tools carefully, and keep them in a safe place.
 - HP Recovery Manager examines the computer and determines the required storage capacity for the media that will be required.
 - To create recovery discs, your computer must have an optical drive with DVD writer capability, and you must use only high-quality blank DVD-R, DVD+R, DVD-R DL, or DVD+R DL discs. Do not use rewritable discs such as CD±RW, DVD±RW, double-layer DVD±RW, or BD-RE (rewritable Blu-ray) discs; they are not compatible with HP Recovery Manager software. Or, instead, you can use a high-quality blank USB flash drive.
 - If your computer does not include an integrated optical drive with DVD writer capability, but you would like to create DVD recovery media, you can use an external optical drive (purchased separately) to create recovery discs. If you use an external optical drive, it must be connected directly to a USB port on the computer; the drive cannot be connected to a USB port on an external device, such as a USB hub. If you cannot create DVD media yourself, you can obtain recovery discs for your computer from HP. See the *Worldwide Telephone Numbers* booklet included with the computer. You can also find contact information on the HP website. Go to <http://www.hp.com/support>, select your country or region, and follow the on-screen instructions.
 - Be sure that the computer is connected to AC power before you begin creating the recovery media.
 - The creation process can take an hour or more. Do not interrupt the creation process.
 - If necessary, you can exit the program before you have finished creating all of the recovery DVDs. HP Recovery Manager will finish burning the current DVD. The next time you start HP Recovery Manager, you will be prompted to continue.

To create HP Recovery media:

 **IMPORTANT:** For a tablet with a detachable keyboard, connect the keyboard to the keyboard dock before beginning these steps.

1. Type `recovery` in the taskbar search box, and then select **HP Recovery Manager**.
2. Select **Create recovery media**, and then follow the on-screen instructions.

If you ever need to recover the system, see [Recovering using HP Recovery Manager on page 86](#).

Using Windows tools

You can create recovery media, system restore points, and backups of personal information using Windows tools.

 **NOTE:** If storage is 32 GB or less, Microsoft System Restore is disabled by default.

For more information and steps, see the Get started app.

- ▲ Select the **Start** button, and then select the **Get started** app.

Restore and recovery

There are several options for recovering your system. Choose the method that best matches your situation and level of expertise:

 **IMPORTANT:** Not all methods are available on all products.

- Windows offers several options for restoring from backup, refreshing the computer, and resetting the computer to its original state. For more information see the Get started app.
 - ▲ Select the **Start** button, and then select the **Get started** app.
- If you need to correct a problem with a preinstalled application or driver, use the Reinstall drivers and/or applications option (select products only) of HP Recovery Manager to reinstall the individual application or driver.
 - ▲ Type `recovery` in the taskbar search box, select **HP Recovery Manager**, select **Reinstall drivers and/or applications**, and then follow the on-screen instructions.
- If you want to recover the Windows partition to original factory content, you can choose the System Recovery option from the HP Recovery partition (select products only) or use the HP Recovery media. For more information, see [Recovering using HP Recovery Manager on page 86](#). If you have not already created recovery media, see [Creating HP Recovery media \(select products only\) on page 84](#).
- On select products, if you want to recover the computer's original factory partition and content, or if you have replaced the hard drive, you can use the Factory Reset option of HP Recovery media. For more information, see [Recovering using HP Recovery Manager on page 86](#).
- On select products, if you want to remove the recovery partition to reclaim hard drive space, HP Recovery Manager offers the Remove Recovery Partition option.

For more information, see [Removing the HP Recovery partition \(select products only\) on page 89](#).

Recovering using HP Recovery Manager

HP Recovery Manager software allows you to recover the computer to its original factory state by using the HP Recovery media that you either created or that you obtained from HP, or by using the HP Recovery partition (select products only). If you have not already created recovery media, see [Creating HP Recovery media \(select products only\) on page 84](#).

What you need to know before you get started

- HP Recovery Manager recovers only software that was installed at the factory. For software not provided with this computer, you must either download the software from the manufacturer's website or reinstall the software from the media provided by the manufacturer.

 **IMPORTANT:** Recovery through HP Recovery Manager should be used as a final attempt to correct computer issues.

- HP Recovery media must be used if the computer hard drive fails. If you have not already created recovery media, see [Creating HP Recovery media \(select products only\) on page 84](#).
- To use the Factory Reset option (select products only), you must use HP Recovery media. If you have not already created recovery media, see [Creating HP Recovery media \(select products only\) on page 84](#).
- If your computer does not allow the creation of HP Recovery media or if the HP Recovery media does not work, you can obtain recovery media for your system from support. See the *Worldwide Telephone Numbers* booklet included with the computer. You can also find contact information from the HP

website. Go to <http://www.hp.com/support>, select your country or region, and follow the on-screen instructions.

 **IMPORTANT:** HP Recovery Manager does not automatically provide backups of your personal data. Before beginning recovery, back up any personal data you want to retain.

Using HP Recovery media, you can choose from one of the following recovery options:

 **NOTE:** Only the options available for your computer display when you start the recovery process.

- System Recovery—Reinstalls the original operating system, and then configures the settings for the programs that were installed at the factory.
- Factory Reset—Restores the computer to its original factory state by deleting all information from the hard drive and re-creating the partitions. Then it reinstalls the operating system and the software that was installed at the factory.

The HP Recovery partition (select products only) allows System Recovery only.

Using the HP Recovery partition (select products only)

The HP Recovery partition allows you to perform a system recovery without the need for recovery discs or a recovery USB flash drive. This type of recovery can be used only if the hard drive is still working.

To start HP Recovery Manager from the HP Recovery partition:

 **IMPORTANT:** For a tablet with a detachable keyboard, connect the keyboard to the keyboard dock before beginning these steps (select products only).

1. Type `recovery` in the taskbar search box, select **Recovery Manager**, and then select **HP Recovery Environment**.

- or -

For computers or tablets with keyboards attached, press **f11** while the computer boots, or press and hold **f11** as you press the power button.

For tablets without keyboards:

Turn on or restart the tablet, and then quickly hold down the volume down button; then select **f11**.

- or -

Turn on or restart the tablet, and then quickly hold down the Windows button; then select **f11**.

2. Select **Troubleshoot** from the boot options menu.
3. Select **Recovery Manager**, and then follow the on-screen instructions.

Using HP Recovery media to recover

You can use HP Recovery media to recover the original system. This method can be used if your system does not have an HP Recovery partition or if the hard drive is not working properly.

1. If possible, back up all personal files.
2. Insert the HP Recovery media, and then restart the computer.

 **NOTE:** If the computer does not automatically restart in HP Recovery Manager, change the computer boot order. See [Changing the computer boot order on page 88](#).

3. Follow the on-screen instructions.

Changing the computer boot order

If your computer does not restart in HP Recovery Manager, you can change the computer boot order, which is the order of devices listed in BIOS where the computer looks for startup information. You can change the selection to an optical drive or a USB flash drive.

To change the boot order:



IMPORTANT: For a tablet with a detachable keyboard, connect the keyboard to the keyboard dock before beginning these steps.

1. Insert the HP Recovery media.
2. Access BIOS:

For computers or tablets with keyboards attached:

- ▲ Turn on or restart the computer or tablet, quickly press **esc**, and then press **f9** for boot options.

For tablets without keyboards:

- ▲ Turn on or restart the tablet, and then quickly hold down the volume down button; then select **f9**.

- or -

Turn on or restart the tablet, and then quickly hold down the Windows button; then select **f9**.

3. Select the optical drive or USB flash drive from which you want to boot.
4. Follow the on-screen instructions.

Removing the HP Recovery partition (select products only)

HP Recovery Manager software allows you to remove the HP Recovery partition to free up hard drive space.



IMPORTANT: After you remove the HP Recovery partition, you will not be able to perform System Recovery or create HP recovery media from the HP Recovery partition. So before you remove the Recovery partition, create HP Recovery media; see [Creating HP Recovery media \(select products only\) on page 84](#).



NOTE: The Remove Recovery Partition option is only available on products that support this function.

Follow these steps to remove the HP Recovery partition:

1. Type `recovery` in the taskbar search box, and then select **HP Recovery Manager**.
2. Select **Remove Recovery Partition**, and then follow the on-screen instructions.

12 Backing up and recovering Windows 8

To protect your information, use Windows backup and restore utilities to back up individual files and folders, back up your entire hard drive, create system repair media (select models only) by using the installed optical drive (select models only) or an optional external optical drive, or create system restore points. In case of system failure, you can use the backup files to restore the contents of your computer.

From the Start screen, type `restore`, and then select from the list of displayed options.

 **NOTE:** For detailed instructions on various backup and restore options, perform a search for these topics in Windows Help and Support.

In case of system instability, HP recommends that you print the recovery procedures and save them for later use.

 **NOTE:** Windows includes the User Account Control feature to improve the security of your computer. You may be prompted for your permission or password for tasks such as installing software, running utilities, or changing Windows settings. For more information, see Windows Help and Support.

Backing up your information

Recovery after a system failure is as good as your most recent backup. You should create system repair media and your initial backup immediately after initial system setup. As you add new software and data files, you should continue to back up your system on a regular basis to maintain a reasonably current backup.

For more information on the Windows backup features, see Windows Help and Support.

Performing a system recovery

In case of system failure or instability, the computer provides the following tools to recover your files:

- **Windows recovery tools:** You can use Windows Backup and Restore to recover information you have previously backed up. You can also use Windows Automatic Repair to fix problems that might prevent Windows from starting correctly.
- **f11 recovery tools:** You can use the [f11](#) recovery tools to recover your original hard drive image. The image includes the Windows operating system and software programs installed at the factory.

 **NOTE:** If you are unable to boot (start up) your computer and you cannot use the system repair media you previously created (select models only), you must purchase Windows operating system media to reboot the computer and repair the operating system. For additional information, see [Using Windows operating system media \(purchased separately\) on page 92](#).

Using the Windows recovery tools

To recover information you previously backed up, see Windows Help and Support for steps on restoring files and folders.

To recover your information using Automatic Repair, follow these steps:

 **CAUTION:** Some Startup Repair options will completely erase and reformat the hard drive. All files you have created and any software installed on the computer are permanently removed. When reformatting is complete, the recovery process restores the operating system, as well as the drivers, software, and utilities from the backup used for recovery.

1. If possible, back up all personal files.
2. If possible, check for the presence of the Recovery Image partition and the Windows partition.

From the Start screen, type `file`, and then click **File Explorer**.

– or –

From the Start screen, type `pc`, and then select **This PC**.

 **NOTE:** If the Windows partition and the Recovery Image partition are not listed, you must recover your operating system and programs using the Windows operating system DVD and the *Driver Recovery* media (both purchased separately). For additional information, see [Using Windows operating system media \(purchased separately\) on page 92](#).

3. If the Windows partition and the Recovery Image partition are listed, restart the computer by pressing and holding the `shift` key while clicking **Restart**.
4. Select **Troubleshoot**, then select **Advanced Options**, and then select **Startup Repair**.
5. Follow the on-screen instructions.

 **NOTE:** For additional information on recovering information using the Windows tools, perform a search for these topics in Windows Help and Support.

Using f11 recovery tools

 **CAUTION:** Using `f11` completely erases hard drive contents and reformats the hard drive. All files that you have created and any software that you have installed on the computer are permanently removed. The `f11` recovery tool reinstalls the operating system and HP programs and drivers that were installed at the factory. Software not installed at the factory must be reinstalled.

To recover the original hard drive image using `f11`:

1. If possible, back up all personal files.
2. If possible, check for the presence of the Recovery Image partition: From the Start screen, type `pc`, and then select **This PC**.

 **NOTE:** If the Recovery Image partition is not listed, you must recover your operating system and programs using the Windows operating system media and the *Driver Recovery* media (both purchased separately). For additional information, see [Using Windows operating system media \(purchased separately\) on page 92](#).

3. If the Recovery Image partition is listed, restart the computer, and then press `esc` while the “Press the ESC key for Startup Menu” message is displayed at the bottom of the screen.
4. Press `f11` while the “Press <F11> for recovery” message is displayed on the screen.
5. Follow the on-screen instructions.

Using Windows operating system media (purchased separately)

To order a Windows operating system DVD, contact support. See the *Worldwide Telephone Numbers* booklet included with the computer. You can also find contact information from the HP website. Go to <http://www.hp.com/support>, select your country or region, and follow the on-screen instructions.

 **CAUTION:** Using a Windows operating system media completely erases hard drive contents and reformats the hard drive. All files that you have created and any software that you have installed on the computer are permanently removed. When reformatting is complete, the recovery process helps you restore the operating system, as well as drivers, software, and utilities.

To initiate a full install of the operating system using a Windows operating system DVD:

 **NOTE:** This process takes several minutes.

1. If possible, back up all personal files.
2. Insert the Windows operating system DVD into the optical drive, and then restart the computer.
3. When prompted, press any keyboard key.
4. Follow the on-screen instructions.

After the installation is completed:

1. Eject the Windows operating system media and then insert the *Driver Recovery* media.
2. Install the Hardware Enabling Drivers first, and then install Recommended Applications.

Using Windows Refresh or Windows Reset

When your computer is not working properly and you need to regain system stability, the Windows Refresh option allows you to start fresh and keep what is important to you.

The Windows Reset option allows you to perform detailed reformatting of your computer, or remove personal information before you give away or recycle your computer. For more information on these features, see Windows Help and Support.

Using HP Software Setup

HP Software Setup can be used to reinstall drivers or select software that has been corrupted or deleted from the system.

1. From the Start screen, type `HP Software Setup`.
2. Open HP Software Setup.
3. Follow the on-screen directions to reinstall drivers or select software.

13 Backing up and recovering Windows 7

Your computer includes HP and Windows tools to help you safeguard your information and retrieve it if you ever need to. These tools will help you return your computer to a proper working state, all with simple steps. This section provides information about the following processes:

- Creating recovery media and backups
- Restoring and recovering your system

Creating recovery media and backups

Recovery after a system failure is only as good as your most recent backup.

1. After you successfully set up the computer, create HP Recovery media. This step creates a Windows 7 operating system DVD and a *Driver Recovery* DVD. The Windows DVD can be used to reinstall the original operating system in cases where the hard drive is corrupted or has been replaced. The *Driver Recovery* DVD installs specific drivers and applications. See [Creating recovery media with HP Recovery Disc Creator on page 94](#).
2. Use Windows Backup and Recovery tools to perform the following:
 - Back up individual files and folders
 - Back up your entire hard drive (select models only)
 - Create system repair discs (select models only) with the installed optical drive (select models only) or an optional external optical drive
 - Create system restore points

 **NOTE:** This guide describes an overview of backing up, restoring, and recovering options. For more details about the tools provided, see Help and Support. To access Help and Support, select **Start > Help and Support**.

 **NOTE:** HP recommends that you print the recovery procedures and save them for later use, in case of system instability.

In case of system failure, you can use the backup files to restore the contents of your computer. See [Backing up your information on page 95](#).

Guidelines

- When creating recovery media or backing up to discs, use any of the following types of discs (purchased separately): DVD+R, DVD+R DL, DVD-R, DVD-R DL, or DVD±RW. The discs you use will depend on the type of optical drive you are using.
- Be sure that the computer is connected to AC power before you start the recovery media creation process or the backup process.

Creating recovery media with HP Recovery Disc Creator

HP Recovery Disc Creator is a software program that offers an alternative way to create recovery media. After you successfully set up the computer, you can create recovery media using HP Recovery Disc Creator. This recovery media allows you to reinstall your original operating system as well as select drivers and

applications if the hard drive becomes corrupted. HP Recovery Disc Creator can create two kinds of recovery DVDs:

- Windows 7 operating system DVD—Installs the operating system without additional drivers or applications.
- *Driver Recovery* DVD—Installs specific drivers and applications only, in the same way that the HP Software Setup utility installs drivers and applications.

Creating recovery media

 **NOTE:** The Windows 7 operating system DVD can be created only once. Thereafter, the option to create that media will not be available after you create a Windows DVD.

To create the Windows DVD:

1. Select **Start > All Programs > Productivity and Tools > HP Recovery Disc Creator**.
2. Select **Windows disk**.
3. From the drop-down menu, select the drive for burning the recovery media.
4. Click the **Create** button to start the burning process.

After the Windows 7 operating system DVD has been created, create the *Driver Recovery* DVD:

1. Select **Start > All Programs > Productivity and Tools > HP Recovery Disc Creator**.
2. Select **Driver disk**.
3. From the drop-down menu, select the drive for burning the recovery media.
4. Click the **Create** button to start the burning process.

Backing up your information

You should create system repair media and your initial backup immediately after initial system setup. As you add new software and data files, you should continue to back up your system on a regular basis to maintain a reasonably current backup. You should also create Windows system repair media (select models only) which can be used to start up (boot) the computer and repair the operating system in case of system instability or failure. Your initial and subsequent backups allow you to restore your data and settings if a failure occurs.

You can back up your information to an optional external hard drive, a network drive, or discs.

Note the following when backing up:

- Store personal files in the Documents library, and back it up regularly.
- Back up templates that are stored in their associated directories.
- Save customized settings that appear in a window, toolbar, or menu bar by taking a screen shot of your settings. The screen shot can be a time-saver if you have to reset your preferences.
- When backing up to discs, number each disc after removing it from the drive.

 **NOTE:** For detailed instructions on various backup and restore options, perform a search for these topics in Help and Support. To access Help and Support, select **Start > Help and Support**.

 **NOTE:** Windows includes the User Account Control feature to improve the security of your computer. You may be prompted for your permission or password for tasks such as installing software, running utilities, or changing Windows settings. Refer to Help and Support. To access Help and Support, select **Start > Help and Support**.

To create a backup using Windows Backup and Restore:



NOTE: The backup process may take over an hour, depending on file size and the speed of the computer.

1. Select **Start > All Programs > Maintenance > Backup and Restore**.
2. Follow the on-screen instructions to set up your backup, create a system image (select models only), or create system repair media (select models only).

Performing a system recovery

In case of system failure or instability, the computer provides the following tools to recover your files:

- Windows recovery tools: You can use Windows Backup and Restore to recover information you have previously backed up. You can also use Windows Startup Repair to fix problems that might prevent Windows from starting correctly.
- f11 recovery tools (select models only): You can use the f11 recovery tools to recover your original hard drive image. The image includes the Windows operating system and software programs installed at the factory.



NOTE: If you are unable to boot (start up) your computer and you cannot use the system repair media you previously created (select models only), you must purchase Windows 7 operating system media to reboot the computer and repair the operating system. For additional information, see [Using Windows 7 operating system media on page 97](#).

Using the Windows recovery tools

Using the Windows recovery tools, you can:

- Recover individual files
- Restore the computer to a previous system restore point
- Recover information using recovery tools



NOTE: For detailed instructions on various recovery and restore options, perform a search for these topics in Help and Support. To access Help and Support, select **Start > Help and Support**.



NOTE: Windows includes the User Account Control feature to improve the security of your computer. You may be prompted for your permission or password for tasks such as installing software, running utilities, or changing Windows settings. Refer to Help and Support. To access Help and Support, select **Start > Help and Support**.

To recover information you previously backed up:

1. Select **Start > All Programs > Maintenance > Backup and Restore**.
2. Follow the on-screen instructions to recover your system settings, your computer (select models only), or your files.

To recover your information using Startup Repair, follow these steps:



CAUTION: Some Startup Repair options will completely erase and reformat the hard drive. All files you have created and any software installed on the computer are permanently removed. When reformatting is complete, the recovery process restores the operating system, as well as the drivers, software, and utilities from the backup used for recovery.

1. If possible, back up all personal files.
2. If possible, check for the presence of the Windows partition.

To check for the Windows partition, select **Start > Computer**.

 **NOTE:** If the Windows partition is not listed, you must recover your operating system and programs using the Windows 7 operating system DVD and the *Driver Recovery* media. For additional information, see [Using Windows 7 operating system media on page 97](#).

3. If the Windows partition is listed, restart the computer, and then press **f8** before the Windows operating system loads.
4. Select **Startup Repair**.
5. Follow the on-screen instructions.

 **NOTE:** For additional information on recovering information using the Windows tools, select **Start > Help and Support**.

Using f11 recovery tools (select models only)

 **CAUTION:** Using **f11** completely erases hard drive contents and reformats the hard drive. All files that you have created and any software that you have installed on the computer are permanently removed. The **f11** recovery tool reinstalls the operating system and HP programs and drivers that were installed at the factory. Software not installed at the factory must be reinstalled.

To recover the original hard drive image using **f11**:

1. If possible, back up all personal files.
2. If possible, check for the presence of the HP Recovery partition: click **Start**, right-click **Computer**, click **Manage**, and then click **Disk Management**.

 **NOTE:** If the HP Recovery partition is not listed, you must recover your operating system and programs using the Windows 7 operating system media and the *Driver Recovery* media. For additional information, see [Using Windows 7 operating system media on page 97](#).

3. If the HP Recovery partition is listed, restart the computer, and then press **f11** before the Windows operating system loads.
4. Follow the on-screen instructions.

Using Windows 7 operating system media

If you cannot use the recovery media you previously created using the HP Recovery Disc Creator (select models only), you must purchase a Windows 7 operating system DVD to reboot the computer and repair the operating system.

To order a Windows 7 operating system DVD, go to the HP website. For U.S. support, go to <http://www.hp.com/support>. For worldwide support, go to http://welcome.hp.com/country/us/en/wwcontact_us.html. You can also order the DVD by calling support. For contact information, see the *Worldwide Telephone Numbers* booklet included with the computer.

 **CAUTION:** Using a Windows 7 operating system DVD completely erases hard drive contents and reformats the hard drive. All files that you have created and any software that you have installed on the computer are permanently removed. When reformatting is complete, the recovery process helps you restore the operating system, as well as drivers, software, and utilities.

To initiate recovery using a Windows 7 operating system DVD:



NOTE: This process takes several minutes.

1. If possible, back up all personal files.
2. Restart the computer, and then insert the Windows 7 operating system DVD into the optical drive before the Windows operating system loads.
3. When prompted, press any keyboard key.
4. Follow the on-screen instructions.
5. Click **Next**.
6. Select **Repair your computer**.
7. Follow the on-screen instructions.

After the repair is completed:

1. Eject the Windows 7 operating system DVD and then insert the *Driver Recovery* DVD.
2. Install the Hardware Enabling Drivers first, and then install Recommended Applications.

14 Specifications

Input power

The power information in this section may be helpful if you plan to travel internationally with the computer.

The computer operates on DC power, which can be supplied by an AC or a DC power source. The AC power source must be rated at 100–240 V, 50–60 Hz. Although the computer can be powered from a standalone DC power source, it should be powered only with an AC adapter or a DC power source supplied and approved by HP for use with this computer.

The computer can operate on DC power within the following specifications.

Input Power	Rating
Operating voltage and current	19.5 V dc @ 2.31 A – 45 W
	19.5 V dc @ 3.33 A – 65 W

 **NOTE:** This product is designed for IT power systems in Norway with phase-to-phase voltage not exceeding 240 V rms.

 **NOTE:** The computer operating voltage and current can be found on the system regulatory label.

Operating environment

Factor	Metric	U.S.
Temperature		
Operating (writing to optical disc)	5°C to 35°C	41°F to 95°F
Nonoperating	-20°C to 60°C	-4°F to 140°F
Relative humidity (noncondensing)		
Operating	10% to 90%	10% to 90%
Nonoperating	5% to 95%	5% to 95%
Maximum altitude (unpressurized)		
Operating	-15 m to 3,048 m	-50 ft to 10,000 ft
Nonoperating	-15 m to 12,192 m	-50 ft to 40,000 ft

15 Power cord set requirements

The wide-range input feature of the computer permits it to operate from any line voltage from 100 to 120 volts AC, or from 220 to 240 volts AC.

The 3-conductor power cord set included with the computer meets the requirements for use in the country or region where the equipment is purchased.

Power cord sets for use in other countries and regions must meet the requirements of the country or region where the computer is used.

Requirements for all countries

The following requirements are applicable to all countries and regions:

- The length of the power cord set must be at least **1.0 m** (3.3 ft) and no more than **2.0 m** (6.5 ft).
- All power cord sets must be approved by an acceptable accredited agency responsible for evaluation in the country or region where the power cord set will be used.
- The power cord sets must have a minimum current capacity of 10 amps and a nominal voltage rating of 125 or 250 V AC, as required by the power system of each country or region.
- The appliance coupler must meet the mechanical configuration of an EN 60 320/IEC 320 Standard Sheet C13 connector for mating with the appliance inlet on the back of the computer.

Requirements for specific countries and regions

Country/region	Accredited agency	Applicable note number
Australia	EANSW	1
Austria	OVE	1
Belgium	CEBC	1
Canada	CSA	2
Denmark	DEMKO	1
Finland	FIMKO	1
France	UTE	1
Germany	VDE	1
Italy	IMQ	1
Japan	METI	3
The Netherlands	KEMA	1
Norway	NEMKO	1
The People's Republic of China	COC	5
South Korea	EK	4

Country/region	Accredited agency	Applicable note number
Sweden	SEMKO	1
Switzerland	SEV	1
Taiwan	BSMI	4
The United Kingdom	BSI	1
The United States	UL	2

1. The flexible cord must be Type H05VV-F, 3-conductor, 1.0-mm² conductor size. Power cord set fittings (appliance coupler and wall plug) must bear the certification mark of the agency responsible for evaluation in the country or region where it will be used.
2. The flexible cord must be Type SPT-3 or equivalent, No. 18 AWG, 3-conductor. The wall plug must be a two-pole grounding type with a NEMA 5-15P (15 A, 125 V) or NEMA 6-15P (15 A, 250 V) configuration.
3. The appliance coupler, flexible cord, and wall plug must bear a “T” mark and registration number in accordance with the Japanese Dentori Law. The flexible cord must be Type VCT or VCTF, 3-conductor, 1.00-mm² conductor size. The wall plug must be a two-pole grounding type with a Japanese Industrial Standard C8303 (7 A, 125 V) configuration.
4. The flexible cord must be Type RVV, 3-conductor, 0.75-mm² conductor size. Power cord set fittings (appliance coupler and wall plug) must bear the certification mark of the agency responsible for evaluation in the country or region where it will be used.
5. The flexible cord must be Type VCTF, 3-conductor, 0.75-mm² conductor size. Power cord set fittings (appliance coupler and wall plug) must bear the certification mark of the agency responsible for evaluation in the country or region where it will be used.

16 Statement of memory volatility

The purpose of this chapter is to provide general information regarding nonvolatile memory in HP Business PCs. This chapter also provides general instructions for restoring nonvolatile memory that can contain personal data after the system has been powered off and the hard drive has been removed.

HP Business PC products that use Intel®-based or AMD®-based system boards contain volatile DDR memory. The amount of nonvolatile memory present in the system depends upon the system configuration. Intel-based and AMD-based system boards contain nonvolatile memory subcomponents as originally shipped from HP, assuming that no subsequent modifications have been made to the system and assuming that no applications, features, or functionality have been added to or installed on the system.

Following system shutdown and removal of all power sources from an HP Business PC system, personal data can remain on volatile system memory (DIMMs) for a finite period of time and will also remain in nonvolatile memory. Use the steps below to remove personal data from the PC, including the nonvolatile memory found in Intel-based and AMD-based system boards.

1. Follow steps (a) through (j) below to restore the nonvolatile memory that can contain personal data. Restoring or reprogramming nonvolatile memory that does not store personal data is neither necessary nor recommended.

- a. Turn on or restart the computer, and then press **esc** while the “Press the ESC key for Startup Menu” message is displayed at the bottom of the screen.



NOTE: If the system has a BIOS administrator password, enter the password at the prompt.

- b. Select **Main**, select **Restore Defaults**, and then select **Yes** to load defaults.
- c. Select the **Security** menu, select **Restore Security Level Defaults**, and then select **Yes** to restore security level defaults.
- d. If an asset or ownership tag is set, select the **Security** menu and scroll down to the **Utilities** menu. Select **System IDs**, and then select **Asset Tracking Number**. Clear the tag, and then make the selection to return to the prior menu.
- e. If a DriveLock password is set, select the **Security** menu, and scroll down to **Hard Drive Tools** under the **Utilities** menu. Select **Hard Drive Tools**, select **DriveLock**, then uncheck the checkbox for **DriveLock password on restart**. Select **OK** to proceed.
- f. If an Automatic DriveLock password is set, select the **Security** menu, scroll down to **Hard Drive Tools** under the **Utilities** menu. Select **Hard Drive Tools**, scroll down to **Automatic DriveLock**, then select the desired hard drive and disable protection. At the automatic drive lock warning screen, select **Yes** to continue. Repeat this procedure if more than one hard drive has an Automatic DriveLock password.
- g. Select the **Main** menu, and then select **Reset BIOS Security to factory default**. Click **Yes** at the warning message.
- h. Select the **Main** menu, select **Save Changes and Exit**, select **Yes** to save changes and exit, and then select **Shutdown**.

- i. Reboot the system. If the system has a Trusted Platform Module (TPM) and/or fingerprint reader, one or two prompts will appear—one to clear the TPM and the other to Reset Fingerprint Sensor; press or tap **F1** to accept or **F2** to reject.
 - j. Remove all power and system batteries for at least 24 hours.
2. Complete one of the following:
- Remove and retain the storage drive.
 - or –
 - Clear the drive contents by using a third party utility designed to erase data from an SSD.
 - or –
 - Clear the contents of the drive by using the following BIOS Setup Secure Erase command option steps:

 **IMPORTANT:** If you clear data using Secure Erase, it cannot be recovered.

- a. Turn on or restart the computer, and then press **esc** while the “Press the ESC key for Startup Menu” message is displayed at the bottom of the screen.
 - b. Select the **Security** menu and scroll down to the **Utilities** menu.
 - c. Select **Hard Drive Tools**.
 - d. Under **Utilities**, select **Secure Erase**, select the hard drive storing the data you want to clear, and then follow the on-screen instructions to continue.
- or –
- Clear the contents of the drive by using the following Disk Sanitizer command steps:

 **IMPORTANT:** If you clear data using Disk Sanitizer, it cannot be recovered.

 **NOTE:** The amount of time it takes for Disk Sanitizer to run can take several hours. Plug the computer into an AC outlet before starting.

- a. Turn on or restart the computer, and then press **esc** while the “Press the ESC key for Startup Menu” message is displayed at the bottom of the screen.
- b. Select the **Security** menu and scroll down to the **Utilities** menu.
- c. Select **Hard Drive Tools**.
- d. Under **Utilities**, select **Disk Sanitizer**, select the hard drive storing the data you want to clear, and then follow the on-screen instructions to continue.

Nonvolatile memory usage

Nonvolatile Memory Type	Amount (Size)	Does this memory store customer data?	Does this memory retain data when power is removed?	What is the purpose of this memory?	How is data input into this memory?	How is this memory write-protected?
HP Sure Start flash (select models only)	2 MBytes	No	Yes	Provides protected backup of critical System BIOS code, EC firmware, and critical PC configuration data for select platforms that support HP Sure Start. For more information, see Using HP Sure Start (select models only) on page 107 .	Data cannot be written to this device via the host processor. The content is managed solely by the HP Sure Start Embedded Controller.	This memory is protected by the HP Sure Start Embedded Controller.
Real Time Clock (RTC) battery backed-up CMOS configuration memory	256 Bytes	No	Yes	Stores system date and time and noncritical data.	RTC battery backed-up CMOS is programmed using the Computer Setup (BIOS), or changing the Microsoft Windows date & time.	This memory is not write-protected.
Controller (NIC) EEPROM	64 KBytes (not customer accessible)	No	Yes	Stores NIC configuration and NIC firmware.	NIC EEPROM is programmed using a utility from the NIC vendor that can be run from DOS.	A utility is required to write data to this memory and is available from the NIC vendor. Writing data to this ROM in an inappropriate manner will render the NIC non-functional.
DIMM Serial Presence Detect (SPD) configuration data	256 Bytes per memory module, 128 Bytes programmable (not customer accessible)	No	Yes	Stores memory module information.	DIMM SPD is programmed by the memory vendor.	Data cannot be written to this memory when the module is installed in a PC. The specific write-protection method varies by memory vendor.
System BIOS	4 MBytes to 5 MBytes	Yes	Yes	Stores system BIOS code and PC configuration data.	System BIOS code is programmed at the factory. Code is updated when the system BIOS is updated. Configuration data and settings are input using the Computer Setup (BIOS) or a custom utility.	NOTE: Writing data to this ROM in an inappropriate manner can render the PC non-functional. A utility is required for writing data to this memory and is available on the HP website; go to http://www.hp.com/support , and select your country. Select Drivers &

Nonvolatile Memory Type	Amount (Size)	Does this memory store customer data?	Does this memory retain data when power is removed?	What is the purpose of this memory?	How is data input into this memory?	How is this memory write-protected?
Intel Management Engine Firmware (present in only specific ZBook and EliteBook models. For more information, go to http://www.hp.com/support , and select your country. Select Drivers & Downloads , and then follow the on-screen instructions.)	1.5 MBytes or 5 MBytes	Yes	Yes	Stores Management Engine Code, Settings, Provisioning Data and iAMT third-party data store.	Management Engine Code is programmed at the factory. Code is updated via Intel secure firmware update utility. Unique Provisioning Data can be entered at the factory or by an administrator using the Management Engine (MEBx) setup utility. The third party data store contents can be populated by a remote management console or local applications that have been registered by an administrator to have access to the space.	Downloads , and then follow the on-screen instructions. The Intel chipset is configured to enforce hardware protection to block all direct read/write access to this area. An Intel utility is required for updating the firmware. Only firmware updates digitally signed by Intel can be applied using this utility.
Bluetooth flash	2 Mbit	No	Yes	Stores Bluetooth configuration and firmware.	Bluetooth flash is programmed at the factory. Tools for writing data to this memory are not publicly available but can be obtained from the silicon vendor.	A utility is required for writing data to this memory and is made available through newer versions of the driver whenever the flash requires an upgrade.
802.11 WLAN EEPROM	4 Kbit to 8 Kbit	No	Yes	Stores configuration and calibration data.	802.11 WLAN EEPROM is programmed at the factory. Tools for writing data to this memory are not made public.	A utility is required for writing data to this memory and is typically not made available to the public unless a firmware upgrade is necessary to address a unique issue.
Web camera	64 Kbit	No	Yes	Stores webcam configuration and firmware.	Webcam memory is programmed using a utility from the device manufacturer that can be run from Windows.	A utility is required for writing data to this memory and is typically not made available to the public unless a firmware upgrade is necessary to address a unique issue.
Fingerprint reader	512 KByte flash	Yes	Yes	Stores fingerprint templates.	Fingerprint reader memory is programmed by user enrollment in HP ProtectTools Security Manager.	Only a digitally signed application can make the call to write to the flash.

Questions and answers

1. How can the BIOS settings be restored (returned to factory settings)?



IMPORTANT: Restore defaults does not securely erase any data on your hard drive. See question and answer 6 for steps to securely erase data.

Restore defaults does not reset the Custom Secure Boot keys. See question and answer 7 for information about resetting the keys.

- a. Turn on or restart the computer, and then press **esc** while the “Press the ESC key for Startup Menu” message is displayed at the bottom of the screen.
- b. Select **Main**, and then select **Restore defaults**.
- c. Follow the on-screen instructions.
- d. Select **Main**, select **Save Changes and Exit**, and then follow the on-screen instructions.

2. What is a UEFI BIOS, and how is it different from a legacy BIOS?

The Unified Extensible Firmware Interface (UEFI) BIOS is an industry-standard software interface between the platform firmware and an operating system (OS). It is a replacement for the older BIOS architecture, but supports much of the legacy BIOS functionality.

Like the legacy BIOS, the UEFI BIOS provides an interface to display the system information and configuration settings and to change the configuration of your computer before an OS is loaded. BIOS provides a secure run-time environment that supports a Graphic User Interface (GUI). In this environment, you can use either a pointing device (Touchscreen, TouchPad, pointing stick, or USB mouse) or the keyboard to navigate and make menu and configuration selections. The UEFI BIOS also contains basic system diagnostics.

The UEFI BIOS provides functionality beyond that of the legacy BIOS. In addition, the UEFI BIOS works to initialize the computer’s hardware before loading and executing the OS; the run-time environment allows the loading and execution of software programs from storage devices to provide more functionality, such as advanced hardware diagnostics (with the ability to display more detailed system information) and advanced firmware management and recovery software.

HP has provided options in Computer Setup (BIOS) to allow you to run in legacy BIOS, if required by the operating system. Examples of this requirement would be if you upgrade or downgrade the OS.

3. Where does the UEFI BIOS reside?

The UEFI BIOS resides on a flash memory chip. A utility is required to write to the chip.

4. What kind of configuration data is stored on the DIMM Serial Presence Detect (SPD) memory module? How would this data be written?

The DIMM SPD memory contains information about the memory module, such as size, serial number, data width, speed/timing, voltage, and thermal information. This information is written by the module manufacturer and stored on an EEPROM. This EEPROM cannot be written to when the memory module is installed in a PC. Third-party tools do exist that can write to the EEPROM when the memory module is not installed in a PC. Various third-party tools are available to read SPD memory.

5. What is meant by “Restore the nonvolatile memory found in Intel-based system boards”?

This message relates to clearing the Real Time Clock (RTC) CMOS memory that contains PC configuration data.

6. How can the BIOS security be reset to factory defaults and data erased?

 **IMPORTANT:** Resetting will result in the loss of information.

These steps will not reset Custom Secure Boot Keys. See question and answer 7 for information about resetting the keys.

- a. Turn on or restart the computer, and then press **esc** while the “Press the ESC key for Startup Menu” message is displayed at the bottom of the screen.
- b. Select **Main**, and then select **Reset BIOS Security to Factory Default**.
- c. Follow the on-screen instructions.
- d. Select **Main**, select **Save Changes and Exit**, and then follow the on-screen instructions.

7. How can the Custom Secure Boot Keys be reset?

Secure Boot is a feature to ensure that only authenticated code can start on a platform. If you enabled Secure Boot and created Custom Secure Boot Keys, simply disabling Secure Boot will not clear the keys. You must also select to clear the Custom Secure Boot Keys. Use the same Secure Boot access procedure you used to create the Custom Secure Boot Keys, but make the selection to clear or delete all Secure Boot Keys.

- a. Turn on or restart the computer, and then press **esc** while the “Press the ESC key for Startup Menu” message is displayed at the bottom of the screen.
- b. Select the **Security** menu, select **Secure Boot Configuration**, and then follow the on-screen instructions.
- c. At the **Secure Boot Configuration** window, select **Secure Boot**, select **Clear Secure Boot Keys**, and then follow the on-screen instructions to continue.

Using HP Sure Start (select models only)

Select computer models are configured with HP Sure Start, a technology that continuously monitors your computer's BIOS for attacks or corruption. If the BIOS becomes corrupted or is attacked, HP Sure Start restores the BIOS to its previously safe state, without user intervention. Those select computer models ship with HP Sure Start configured and enabled. HP Sure Start is configured and already enabled so that most users can use the HP Sure Start default configuration. The default configuration can be customized by advanced users.

To access the latest documentation on HP Sure Start, go to <http://www.hp.com/support>, and select your country. Select **Drivers & Downloads**, and then follow the on-screen instructions.

17 Recycling

When a non-rechargeable or rechargeable battery has reached the end of its useful life, do not dispose of the battery in general household waste. Follow the local laws and regulations in your area for battery disposal.

HP encourages customers to recycle used electronic hardware, HP original print cartridges, and rechargeable batteries. For more information about recycling programs, see the HP Web site at <http://www.hp.com/recycle>.

Index

A

AC adapter, spare part numbers 25
adapter
 spare part numbers 25
antennas
 disconnecting 42, 44
audio, product description 2
audio-out (headphone)/audio-in
 (microphone) combo jack,
 identifying 6

B

back cover
 spare part number 22
Backup and Restore 96
backup tools 94
backups 84
 creating 95
 recovering 96
battery
 removal 35
 spare part number 19, 35
battery light 16
bezel
 spare part number 21

BIOS

determining version 69, 74, 79
downloading an update 69, 74,
79
updating 69, 74, 79

Bluetooth card

spare part number 42

boot order

changing 88

bottom cover

spare part number 20, 32

buttons

left pointing stick 10
left TouchPad 10
power 12
right pointing stick 10
right TouchPad 10

C

cable lock docking station, spare part
 number 25
cable lock, spare part number 25
caps lock light, identifying 11
case
 spare part numbers 25
chipset, product description 1
components
 bottom 15
 display 9
 front 15
 left side 8
 right side 6
 top 10
computer major components 18
Computer Setup
 navigating and selecting 67, 72,
 77
 restoring factory settings 68,
 73, 78
connector, power 7

D

display assembly
 removal 61
 spare part numbers 61
 subcomponents 21
display bezel
 removal 62
display cable
 spare part number 22
display hinge
 removal 64
display image, switching 14
display panel
 product description 1
docking connector, identifying 7, 15
docking station, spare part number
 25
drive light 16
Driver Recovery DVD,
 creating 94
 using for restore 97

Dual-Mode DisplayPort

identifying 6

E

embedded numeric keypad,
 identifying 13
esc key, identifying 13
external monitor port 8

F

f11 recovery 91, 97
fingerprint reader assembly
 removal 55
 spare part number 55
fingerprint reader board
 spare part number 19
fingerprint reader, identifying 12
fn key, identifying 13

H

hard drive
 product description 1
 removing 36
 spare part numbers 19, 24, 36
hard drive hardware kit
 spare part number 19, 24
hard drive recovery 91, 97
heat sink
 removal 53
 spare part numbers 53
heat sink/fan assembly
 spare part number 19
hinge
 removal 64
hinges
 spare part number 22
hot keys
 microphone mute 14
 Sleep 13
 switching screen image 14
 using 13
HP PC Hardware Diagnostics (UEFI)
 using 82
HP Recovery Disc Creator, using 94

- HP Recovery Manager
 - correcting boot problems 88
 - starting 87
 - HP Recovery media
 - creating 84
 - recovery 87
 - HP Recovery partition
 - checking for presence 97
 - recovery 87
 - removing 89
 - using for recovery 97
 - HP Sure Start 107
- I**
- input power 99
 - integrated webcam light, identifying 9
 - internal microphones, identifying 9
- J**
- jacks
 - audio-out (headphone)/audio-in (microphone) combo 6
 - network 7
 - RJ-45 (network) 7
- K**
- keyboard
 - product description 3
 - removal 46
 - spare part number 18
 - spare part numbers 46
 - keypad
 - embedded numeric 13
 - keys
 - esc 13
 - fn 13
 - Windows key 13
- L**
- labels
 - serial number 16
 - legacy support, USB 67, 72, 77
 - lights
 - battery 16
 - caps lock 11
 - drive 16
 - microphone mute 11
 - num lock 11
 - power 11, 15
 - RJ-45 (network) 7
 - webcam 9
 - wireless 11, 15
- M**
- memory
 - nonvolatile 102
 - volatile 102
 - memory card reader, identifying 6
 - memory module
 - product description 1
 - removal 40
 - spare part number 19
 - spare part numbers 40
 - microphone
 - product description 2
 - microphone module
 - spare part number 21
 - microphone mute key, identifying 14
 - microphone mute light, identifying 11
 - minimized image recovery 87
 - minimized image, creating 86
 - model name 1
 - mouse
 - spare part numbers 25
- N**
- network jack, identifying 7
 - NFC module
 - removal 57
 - spare part number 57
 - spare part numbers 19
 - nonvolatile memory 102
 - num lock light 11
- O**
- operating environment 99
 - operating system, product description 4
 - original system recovery 86
- P**
- pointing device, product description 3
 - pointing stick 10
 - ports
 - Dual-Mode DisplayPort 6
 - external monitor 8
 - product description 3
 - USB 3.0 charging (powered) 8
 - USB Type-C (charging) 6
 - power button, identifying 12
 - power connector, identifying 7
 - power cord
 - set requirements 100
 - power lights 11, 15
 - power requirements, product description 3
 - processor
 - product description 1
 - product description
 - audio 2
 - chipset 1
 - display panel 1
 - external media cards 3
 - hard drive 1
 - keyboard 3
 - memory module 1
 - microphone 2
 - operating system 4
 - pointing device 3
 - ports 3
 - power requirements 3
 - processors 1
 - product name 1
 - security 3
 - serviceability 5
 - video 2
 - wireless 2
 - product name 1
 - product name and number, computer 16
- R**
- raw panel
 - spare part number 21
 - recover
 - options 86
 - recovery 93
 - discs 85, 87
 - HP Recovery Manager 86
 - media 87
 - starting 87
 - supported discs 85
 - system 86
 - USB flash drive 87
 - using HP Recovery media 85

- recovery media
 - creating 84
 - creating using HP Recovery Manager 85
- recovery media, creating 94
- recovery media, using for restore 97
- recovery partition 91, 97
 - removing 89
- recovery tools 94
- recovery tools, Windows 96
- recovery, system 96
- refresh 93
- regulatory information 16
- removal/replacement
 - procedures 32, 49
- removing personal data from volatile system memory 102
- reset 93
- restoring the hard drive 91, 97
- RJ-45 (network) jack, identifying 7
- RJ-45 (network) lights, identifying 7
- RTC battery
 - removal 52
 - spare part number 20, 52
- rubber kit, spare part number 26

S

- screen image, switching 14
- screw kit, spare part number 26
- security cable slot, identifying 8
- security, product description 3
- serial number 16
- serial number, computer 16
- serviceability, product description 5
- setup utility
 - navigating and selecting 67, 72, 77
 - restoring factory settings 68, 73, 78
- SIM
 - spare part numbers 25
- SIM card slot, identifying 7
- slots
 - security cable 8
 - SIM card 7
 - smart card 8
- smart card reader
 - spare part number 19

- smart card reader board
 - removal 58
 - spare part number 58
- smart card slot 8
- solid-state drive
 - removal 38
 - spare part numbers 19, 24, 38
- speaker assembly
 - removal 59
 - spare part number 20, 59
- speakers, identifying 12
- Startup Repair, using 96
- supported discs, recovery 85
- Sure Start
 - using 71, 76, 81
- system board
 - removal 49
 - spare part number 20
 - spare part numbers 49
- system information
 - locating 16
- system memory, removing personal data from volatile 102
- system recovery 86
- system restore point
 - creating 85
- system restore point, creating 84

T

- top cover
 - removal 65
 - spare part number 65
- TouchPad
 - buttons 10
- touchpad button board
 - removal 56
 - spare part number 19, 56
- TouchPad zone
 - identifying 10
- TPM settings 70, 75, 80

U

- USB 3.0 charging (powered), identifying 8
- USB 3.0 port 6
- USB legacy support 67, 72, 77
- USB ports, identifying 6
- USB Type-C (charging) port, identifying 6

V

- vents, identifying 8, 15
- video, product description 2

W

- warranty period 16
- webcam 9
- webcam light, identifying 9
- webcam module
 - removal 63
 - spare part number 21
- webcam, identifying 9
- Windows
 - Refresh 93
 - Reset 93
 - system restore point 84, 85
- Windows 7 operating system DVD
 - creating 94
 - using for restore 97
- Windows 7 operating system media
 - creating 94
 - using for restore 97
- Windows key, identifying 13
- Windows operating system DVD 92
- Windows Startup Repair, using 96
- Windows tools
 - using 85
- wireless antennas
 - disconnecting 42, 44
- wireless antennas, identifying 9
- wireless light 11, 15
- wireless, product description 2
- WLAN antenna
 - spare part number 22
- WLAN antennas, identifying 9
- WLAN/Bluetooth combo card
 - removal 42
 - spare part number 19, 42
- WWAN antenna
 - spare part number 22
- WWAN antennas, identifying 9
- WWAN module
 - removal 44
 - spare part number 44
 - spare part numbers 19

X

- xxxxxx
 - spare part numbers 18

Free Manuals Download Website

<http://myh66.com>

<http://usermanuals.us>

<http://www.somanuals.com>

<http://www.4manuals.cc>

<http://www.manual-lib.com>

<http://www.404manual.com>

<http://www.luxmanual.com>

<http://aubethermostatmanual.com>

Golf course search by state

<http://golfingnear.com>

Email search by domain

<http://emailbydomain.com>

Auto manuals search

<http://auto.somanuals.com>

TV manuals search

<http://tv.somanuals.com>