



**HP EliteBook 745 G2 Notebook PC**  
**HP EliteBook 755 G2 Notebook PC**

**Maintenance and Service Guide**

© Copyright 2014—2015 Hewlett-Packard Development Company, L.P.

AMD and Radeon are trademarks of Advanced Micro Devices, Inc. Bluetooth is a trademark owned by its proprietor and used by Hewlett-Packard Company under license. Intel is a trademark of Intel Corporation in the U.S. and other countries. Microsoft and Windows are trademarks of the Microsoft group of companies. SD Logo is a trademark of its proprietor.

The information contained herein is subject to change without notice. The only warranties for HP products and services are set forth in the express warranty statements accompanying such products and services. Nothing herein should be construed as constituting an additional warranty. HP shall not be liable for technical or editorial errors or omissions contained herein.

#### **Product notice**

This guide describes features that are common to most models. Some features may not be available on your computer.

Not all features are available in all editions of Windows 8. This computer may require upgraded and/or separately purchased hardware, drivers, and/or software to take full advantage of Windows 8 functionality. See for <http://www.microsoft.com> details.

This computer may require upgraded and/ or separately purchased hardware and/or a DVD drive to install the Windows 7 software and take full advantage of Windows 7 functionality. See <http://windows.microsoft.com/en-us/windows7/get-know-windows-7> for details.

To access the latest user guide, go to <http://www.hp.com/support>, and select your country. Select **Drivers & Downloads**, and then follow the on-screen instructions.

Second Edition: May 2015

First Edition: June 2014

Document Part Number: 764419-002

## Important Notice about Customer Self-Repair Parts

---

 **CAUTION:** Your computer includes Customer Self-Repair parts and parts that should only be accessed by an authorized service provider. See [Removal and replacement procedures for Customer Self-Repair parts on page 47](#) for details. Accessing parts described in [Removal and replacement procedures for Authorized Service Provider parts on page 63](#) can damage the computer or void your warranty.

---



## Safety warning notice

---

 **WARNING!** To reduce the possibility of heat-related injuries or of overheating the device, do not place the device directly on your lap or obstruct the device air vents. Use the device only on a hard, flat surface. Do not allow another hard surface, such as an adjoining optional printer, or a soft surface, such as pillows or rugs or clothing, to block airflow. Also, do not allow the AC adapter to contact the skin or a soft surface, such as pillows or rugs or clothing, during operation. The device and the AC adapter comply with the user-accessible surface temperature limits defined by the International Standard for Safety of Information Technology Equipment (IEC 60950).

---



---

# Table of contents

<b>1 Product description</b>	<b>1</b>
<b>2 External component identification</b>	<b>7</b>
Display	7
Top	8
TouchPad	8
Lights	10
Buttons, speakers, and fingerprint reader (select models only)	11
Keys	13
Front	14
Left	15
Right	16
Bottom	17
Service Label	20
<b>3 Illustrated parts catalog</b>	<b>21</b>
Computer major components	22
Display assembly subcomponents	26
HP EliteBook 745 models	26
HP EliteBook 755 models	28
Mass storage devices	30
Plastics Kit	31
Miscellaneous parts	32
Sequential part number listing	33
<b>4 Removal and replacement procedures preliminary requirements</b>	<b>41</b>
Tools required	41
Service considerations	41
Plastic parts	41
Cables and connectors	41
Drive handling	42

Grounding guidelines .....	42
Electrostatic discharge damage .....	42
Packaging and transporting guidelines .....	44
Workstation guidelines .....	44
<b>5 Removal and replacement procedures for Customer Self-Repair parts .....</b>	<b>47</b>
Component replacement procedures .....	47
Service door .....	47
Battery .....	49
Hard drive .....	50
Memory module .....	52
WWAN module .....	54
WLAN module .....	56
Keyboard .....	58
<b>6 Removal and replacement procedures for Authorized Service Provider parts .....</b>	<b>63</b>
Component replacement procedures .....	63
Display panel (non-touch) .....	63
RTC battery .....	67
Internal base enclosure .....	68
Internal base enclosure (HP EliteBook 745 models) .....	68
Internal base enclosure (HP EliteBook 755 models) .....	71
Fan .....	74
Card reader board .....	75
VGA/USB board .....	77
Heat sink .....	79
Power button board .....	81
Fingerprint reader assembly .....	83
System board .....	85
Speaker assembly .....	90
Display assembly .....	92
<b>7 Computer Setup (BIOS), MultiBoot, and System Diagnostics in Windows 8.1 .....</b>	<b>99</b>
Using Computer Setup .....	99
Starting Computer Setup .....	99
Navigating and selecting in Computer Setup .....	99
Restoring factory settings in Computer Setup .....	100
Updating the BIOS .....	100
Determining the BIOS version .....	101
Downloading a BIOS update .....	101



Using MultiBoot .....	102
About the boot device order .....	102
Choosing MultiBoot preferences .....	102
Setting a new boot order in Computer Setup .....	102
Dynamically choosing a boot device using the f9 prompt .....	103
Setting a MultiBoot Express prompt .....	103
Entering MultiBoot Express preferences .....	104
Using HP PC Hardware Diagnostics (UEFI) (select models only) .....	104
Downloading HP PC Hardware Diagnostics (UEFI) to a USB device .....	105
<b>8 Computer Setup (BIOS) and HP PC Hardware Diagnostics (UEFI) in Windows 7 .....</b>	<b>107</b>
Using Computer Setup .....	107
Starting Computer Setup .....	107
Navigating and selecting in Computer Setup .....	107
Restoring factory settings in Computer Setup .....	108
Updating the BIOS .....	108
Determining the BIOS version .....	109
Downloading a BIOS update .....	109
Using MultiBoot .....	110
About the boot device order .....	110
Choosing MultiBoot preferences .....	110
Setting a new boot order in Computer Setup .....	110
Dynamically choosing a boot device using the f9 prompt .....	111
Setting a MultiBoot Express prompt .....	111
Entering MultiBoot Express preferences .....	112
Using HP PC Hardware Diagnostics (UEFI) (select models only) .....	112
Downloading HP PC Hardware Diagnostics (UEFI) to a USB device .....	112
<b>9 Using Setup Utility (BIOS) and System Diagnostics in Ubuntu .....</b>	<b>115</b>
Starting Setup Utility .....	115
Using Setup Utility .....	115
Changing the language of Setup Utility .....	115
Navigating and selecting in Setup Utility .....	115
Displaying system information .....	116
Restoring factory default settings in Setup Utility .....	116
Exiting Setup Utility .....	116
Using HP PC Hardware Diagnostics (UEFI) .....	116
Downloading HP PC Hardware Diagnostics (UEFI) to a USB device .....	117

<b>10 Backup and recovery in Windows 8.1 .....</b>	<b>119</b>
Backing up your information .....	119
Performing a system recovery .....	119
Using the Windows recovery tools .....	120
Using f11 recovery tools .....	120
Using Windows 8.1 operating system media (purchased separately) .....	121
Using Windows Refresh or Windows Reset .....	122
Using HP Software Setup .....	122
<b>11 Backup and recovery in Windows 7 .....</b>	<b>123</b>
Creating recovery media and backups .....	123
Guidelines .....	124
Creating recovery media with HP Recovery Disc Creator .....	124
Creating recovery media .....	124
Backing up your information .....	124
Performing a system recovery .....	125
Using the Windows recovery tools .....	125
Using f11 recovery tools (select models only) .....	127
Using Windows 7 operating system media .....	127
<b>12 Backing up, restoring, and recovering in Ubuntu .....</b>	<b>129</b>
Creating a restore image .....	129
Creating restore image on DVDs .....	129
Creating a restore image on a USB device .....	130
Restoring the original factory state .....	130
Backing up your data files .....	132
Restoring your data files .....	133
<b>13 Specifications .....</b>	<b>135</b>
Computer specifications—HP EliteBook 745 models .....	135
Computer specifications—HP EliteBook 755 models .....	136
35.6 cm (14.0 in) HD SVA display specifications .....	138
35.6 cm (14.0 in) HD+ SVA display specifications .....	139
35.6 cm (14.0 in) FHD, UWVA display specifications .....	140
39.6 cm (15.6 in) HD SVA display specifications .....	141
39.6 cm (15.6 in) FHD SVA display specifications .....	142
Hard drive specifications .....	143
Solid-state drive specifications .....	144

<b>14 Statement of Volatility .....</b>	<b>145</b>
Non-volatile memory usage .....	146
Questions and answers .....	149
Using HP Sure Start (select models only) .....	150
<b>15 Power cord set requirements .....</b>	<b>151</b>
Requirements for all countries .....	151
Requirements for specific countries and regions .....	152
<b>16 Recycling .....</b>	<b>155</b>
<b>Index .....</b>	<b>157</b>



# 1 Product description

Category	Description	HP EliteBook 745	HP EliteBook 755
<b>Product Name</b>	HP EliteBook 745 G2 Notebook PC	√	
	HP EliteBook 755 G2 Notebook PC		√
<b>Processors</b>	Offers the following processors: <ul style="list-style-type: none"> <li>• AMD™ A6 Pro-7050B with Radeon™ R4 Graphics (dual-core; 3.0 GHz/2.2 GHz; 17 W; 1 MB L2 cache)</li> <li>• AMD A8 Pro-7150B with Radeon R5 Graphics (quad-core; 3.2 GHz/2.0 GHz; 19 W; 4 MB L2 cache)</li> <li>• AMD A10 Pro-7350B with Radeon R6 Graphics (quad-core; 3.3 GHz/2.1 GHz; 19 W; 4 MB L2 cache)</li> </ul>	√	√
<b>Fusion Controller Hub</b>	AMD A76M FCH	√	√
<b>Graphics</b>	AMD UMA Graphics - with shared video memory  Support dual-display ports through the dock  UMA configurations support 3 independent displays when on the HP 2013 UltraSlim Docking Station	√	√
<b>Panel</b>	All display assemblies include two wireless local area network (WLAN) antenna cables and two wireless wide area network (WWAN) antenna cables	√	√
	<ul style="list-style-type: none"> <li>• <b>(35.6 cm)</b> 14.0 in HD AG SVA 45% CG 200 nits (cd/m<sup>2</sup>) eDP 1.2 flat (1366x768) display with and without webcam</li> </ul>	√	
	<ul style="list-style-type: none"> <li>• <b>(35.6 cm)</b> 14.0 in HD+ AG SVA 45% CG 250 nits (cd/m<sup>2</sup>) eDP 1.2 flat (1600x900) display with and without webcam</li> </ul>		
	<ul style="list-style-type: none"> <li>• <b>(35.6 cm)</b> 14.0 in FHD AG UWVA 72% CG 300 nits (cd/m<sup>2</sup>) eDP 1.3 + PSR slim (1920x1080) display with and without webcam</li> </ul>		
	<ul style="list-style-type: none"> <li>• <b>(35.6 cm)</b> 14.0 in FHD UWVA 72% CG 300 nits (cd/m<sup>2</sup>) eDP 1.3 + PSR slim (1920x1080) display with capacitive touch enabled and webcam</li> </ul>		
	<ul style="list-style-type: none"> <li>• <b>(39.6 cm)</b> 15.6 in HD AG SVA 45% CG 200 nits (cd/m<sup>2</sup>) eDP 1.2 flat (1366x768) display with and without webcam</li> </ul>		√
	<ul style="list-style-type: none"> <li>• <b>(39.6 cm)</b> 15.6 in FHD AG SVA 60% CG 300 nits (cd/m<sup>2</sup>) eDP 1.2 slim (1920x1080) display with and without webcam</li> <li>• <b>(39.6 cm)</b> 15.6 in FHD AG SVA 60% CG 300 nits (cd/m<sup>2</sup>) eDP 1.2 slim (1920x1080) display capacitive touch enabled and webcam</li> </ul>		

Category	Description	HP EliteBook 745	HP EliteBook 755
<b>Memory</b>	<p>Two customer-accessible/upgradable memory module slots with the following specifications:</p> <p>DDR3L PC3L-12800 (1600 MHz) SODIMMs</p> <p>Supports dual channel memory</p> <p>Supports 16384 MB of system RAM in the following configurations:</p> <ul style="list-style-type: none"> <li>• 16384 MB (8192 MB×2)</li> <li>• 12288 MB (8192 MB+4096 MB)</li> <li>• 8192 MB (8192 MB×1 or 4096 MB×2)</li> <li>• 6144 MB (4096 MB+2048 MB)</li> <li>• 4096 MB (4096 MB×1)</li> <li>• 2048 MB (2048×1)</li> </ul>	√	√
<b>Primary storage</b>	<p>Supports 2.5 in (6.35 cm) hard drives in 9.5 mm (.37 in) and 7.0 mm (.28 in) thicknesses (all hard drives use the same bracket)</p> <p>Customer-accessible</p>	√	√
	<p>Supports the following hard drives:</p> <ul style="list-style-type: none"> <li>• 1 TB, 7200 rpm</li> <li>• 500 GB, 7200 rpm, self-encrypting drive (SED), supporting Opal 1.0 Storage Specification</li> <li>• 500 GB, 7200 rpm</li> <li>• 500 GB, 5400 rpm, self-encrypting drive (SED, FIPS-140-2), supporting Opal 2.0 Storage Specification</li> <li>• 320 GB, 7200 rpm</li> </ul> <p>Supports the following Solid-State Drives (SSDs):</p> <ul style="list-style-type: none"> <li>• 256 GB SATA III, SED, supporting Opal 2.0</li> <li>• 240 GB, SATA III</li> <li>• 180 GB, SATA III, SED, supporting Opal 1.0</li> <li>• 180 GB, SATA III</li> <li>• 128 GB, SATA III</li> </ul>	√	√
<b>Audio and video</b>	Two stereo speakers	√	√
	HD audio with DTS Sound Studio	√	√
	Integrated 720p webcam (supports no camera option)	√	√
	Integrated dual-array microphone	√	√
<b>Ethernet</b>	Realtek RTL8111EP 10/100/1000 Ethernet NIC with DASH Support	√	√
	S3/S4/S5 wake on LAN		

Category	Description	HP EliteBook 745	HP EliteBook 755
<b>Wireless</b>	<p>Integrated wireless local area network (WLAN) options by way of minicard</p> <p>Two WLAN antennas built into display assembly</p> <p>Support for the following WLAN formats:</p> <ul style="list-style-type: none"> <li>• Qualcomm Atheros AR9485 802.11b/g/n 1x1 WiFi Adaptor (select models only)</li> <li>• Broadcom BCM4352 802.11ac 2x2 Wi-Fi + Bluetooth® 4.0 combo (select models only)</li> <li>• Broadcom BCM943228HMB WiDi 802.11 a/b/g/n 2x2 Wi-Fi + Bluetooth 4.0 combo (select models only)</li> </ul> <p>Supports no WLAN option</p> <p>Compatible with Miracast-certified devices for Windows® 8.1</p>	√	√
	<p>Integrated wireless wide area network (WWAN) options by way of wireless module</p> <p>Two world-wide/5-band WWAN antennas built into display assembly</p> <p>Secured by subscriber identity module (SIM, user-accessible behind battery)</p> <p>Support for the following WWAN formats:</p> <ul style="list-style-type: none"> <li>• HP lt4211 LTE/EV-DO/HSPA+ 4G Mobile Broadband Module</li> <li>• HP lt4112 LTE/HSPA+ 4G Mobile Broadband Module</li> <li>• HP hs3110 HSPA+ Mobile Broadband Module</li> </ul> <p>Supports no WWAN option</p> <p>Supports WWAN after market option</p>	√	√
<b>External media cards</b>	<p>Media reader slot supporting the following digital card formats:</p> <ul style="list-style-type: none"> <li>• Secure Digital (SD) Memory Card</li> <li>• SDHC</li> <li>• SDXC</li> </ul>	√	√

Category	Description	HP EliteBook 745	HP EliteBook 755
<b>Ports</b>	Offers the following ports:	√	√
	<ul style="list-style-type: none"> <li>Headphone/microphone combo</li> <li>DisplayPort 1.2</li> <li>Docking connector</li> <li>USB 3.0 ports (3)</li> <li>USB 3.0 charging port</li> <li>HP Smart AC adapter</li> <li>RJ-45 (Ethernet)</li> <li>VGA (Dsub 15 pin) supporting: 1920×1200 external resolution @ 75 Hz, hot plug and unplug and auto detection for correct output to wide-aspect versus standard aspect video</li> </ul>		
	<ul style="list-style-type: none"> <li>Secondary battery connector</li> </ul>	√	
<b>Keyboard/pointing devices</b>	Glass with chemical etched surface, dual-point, spill-resistant with drain, DuraKeys	√	√
	Backlit (select models only)	√	√
	Gesture support: MultiTouch gestures enabled, two-finger scrolling, and pinch-zoom as default	√	√
	Taps enabled by default	√	√
	Supports two-way scroll	√	√
	On/off button	√	√
<b>Power requirements</b>	Supports the following HP Smart AC adapters:		
	<ul style="list-style-type: none"> <li>65 W HP Smart AC adapter (select models only)</li> </ul>	√	√
	<ul style="list-style-type: none"> <li>45 W HP Smart AC adapter (select models only)</li> </ul>	√	√
	<ul style="list-style-type: none"> <li>45 W 2-prong 7.4 mm DC jack AC adapter (select models only)</li> </ul>	√	√
	Supports the following batteries:	√	√
	<ul style="list-style-type: none"> <li>3 cell, 50 Wh, 4.45 Ah long-life battery</li> <li>3 cell, 24 Wh, 2.2 Ah long-life battery</li> <li>Secondary 6 cell, 60 Wh, 2.7 Ah battery</li> </ul>	√	
<b>Security</b>	Supports security cable lock	√	√
	Supports fingerprint reader and no fingerprint reader option	√	√
	Supports Trusted Platform Module (TPM) 1.2 (Infineon, soldered down) and TPM Enhanced Drive Lock	√	√
	Integrated Smart Card reader (active)	√	√
	Full volume encryption	√	√
	Preboot authentication (password, Smart Card)	√	√
<b>Operating system</b>	Windows 7, Service Pack 1	√	√



Category	Description	HP EliteBook 745	HP EliteBook 755
	<b>Preinstalled:</b>	√	√
	<ul style="list-style-type: none"> <li>• Windows® 8.1 ML 64</li> <li>• Windows 8.1 CH 64</li> <li>• Windows 8.1 EM 64</li> <li>• Windows 8.1 Professional 64</li> <li>• Windows 8.1 Professional 64 DPK with Windows 7 Professional 64 and 32</li> <li>• Windows 7 Home Premium 64</li> <li>• Windows 7 Home Premium 32 (only available if 4096 MB Total System Memory or less is selected)</li> <li>• Windows 7 Home Basic 32 (only available if 4096 MB Total System Memory or less is selected)</li> <li>• Windows 7 Professional 64</li> <li>• Windows 7 Professional 32 (only available if 4096 MB Total System Memory or less is selected)</li> <li>• FreeDOS 2.0</li> <li>• Ubuntu Linux</li> </ul>		
	<b>Restore media—DR-DVD:</b>	√	√
	<ul style="list-style-type: none"> <li>• Windows 8.1 (available with any Windows 8.1 operating system and required with Windows 8.1 Professional downgrade operating system)</li> <li>• Windows 7 (available with any Windows 7 or Windows 8.1 Professional downgrade operating system)</li> </ul>		
	<b>Restore media—OS-DVD:</b>	√	√
	<ul style="list-style-type: none"> <li>• Windows 8.1 Professional 64 (only available and required with Windows 8 Professional downgrade operating system)</li> <li>• Windows 8.1 64</li> <li>• Windows 8.1 Country-Specific 64</li> <li>• Windows 8.1 Emerging Market 64 (available with Windows 8.1 downgrade AVs only except Asia-Pacific countries and regions and the People's Republic of China)</li> <li>• Windows 7 Home Premium 64 and 32 (available with any Windows 7 HP operating system except Asia-Pacific countries and regions and the People's Republic of China)</li> <li>• Windows 7 Professional 64 and 32 (available with any Windows 7 Professional or Windows 8.1 Professional downgrade except Asia-Pacific countries and regions and the People's Republic of China)</li> <li>• Windows 7 Home Basic 32 (available with any Windows 7 Home Basic except Asia-Pacific countries and regions and the People's Republic of China)</li> </ul>		

Category	Description	HP EliteBook 745	HP EliteBook 755
	<b>Certified:</b> <ul style="list-style-type: none"> <li>• Microsoft® WHQL</li> </ul>	√	√
	<b>Web-only support:</b> <ul style="list-style-type: none"> <li>• Windows 8.1 Enterprise 64</li> <li>• Windows 7 Enterprise 64 and 32</li> </ul>	√	√
<b>Serviceability</b>	<b>End user replaceable parts:</b> <ul style="list-style-type: none"> <li>• AC adapter</li> <li>• Battery</li> <li>• HDD/SSD hard drive</li> <li>• Keyboard</li> <li>• Memory module</li> <li>• WLAN module</li> <li>• WWAN module</li> </ul>	√	√

## 2 External component identification

### Display



Component	Description
(1) WLAN antennas (2)* (select models only)	Send and receive wireless signals to communicate with wireless local area networks (WLAN).
(2) WWAN antennas (2)* (select models only)	Send and receive wireless signals to communicate with wireless wide area networks (WWAN).
(3) Internal microphones (2)	Record sound.
(4) Webcam light (select models only)	On: The webcam is in use.

Component	Description
(5) Webcam (select models only)	Records video and captures still photographs.  For information on using the webcam:  <b>Windows 8.1:</b>  On the Start screen, select the <b>HP Support Assistant</b> app.  <b>Windows 7:</b>  Select <b>Start &gt; All Programs &gt; Communication and Chat &gt; HP WebCam</b> .
(6) Internal display switch	Turns off the display or initiates Sleep if the display is closed while the power is on.  <b>NOTE:</b> The display switch is not visible on the outside of the computer.

\*The antennas are not visible on the outside of the computer. For optimal transmission, keep the areas immediately around the antennas free from obstructions. To see wireless regulatory notices, see the section of the *Regulatory, Safety, and Environmental Notices* that applies to your country or region.

## Top

### TouchPad

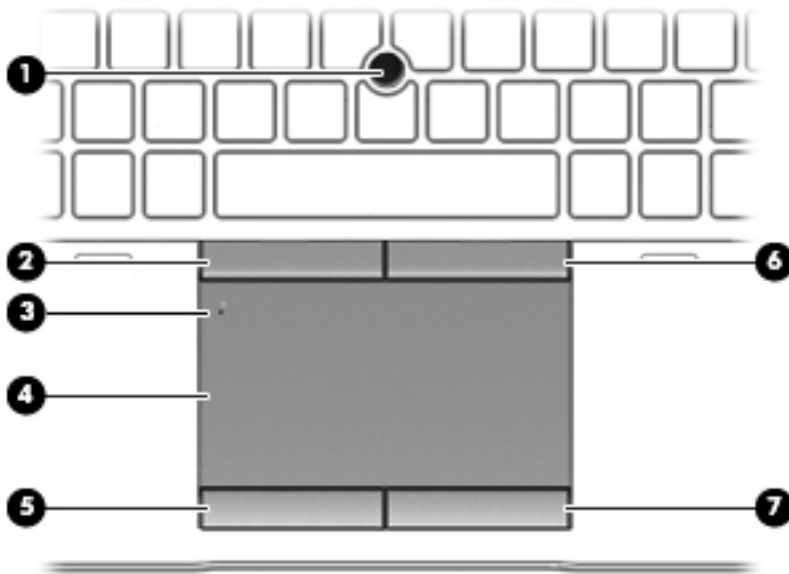

Component	Description
(1) Pointing stick	Moves the pointer and selects or activates items on the screen.
(2) Left pointing stick button	Functions like the left button on an external mouse.
(3) TouchPad on/off button	Turns the TouchPad on and off. (Select models only.)
(4) TouchPad zone	Moves the pointer and selects or activates items on the screen.
(5) Left TouchPad button	Functions like the left button on an external mouse.

<b>Component</b>	<b>Description</b>
<b>(6)</b> Right pointing stick button	Functions like the right button on an external mouse.
<b>(7)</b> Right TouchPad button	Functions like the right button on an external mouse.

## Lights

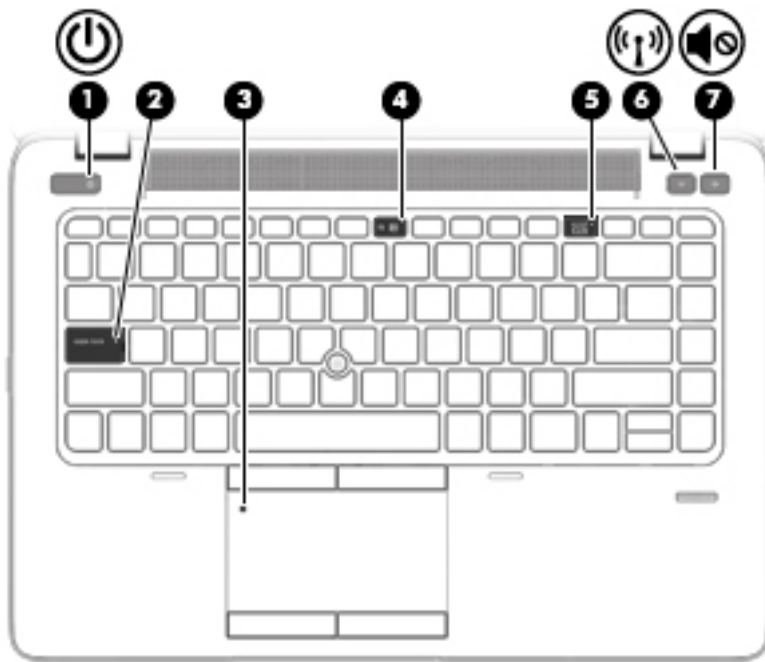

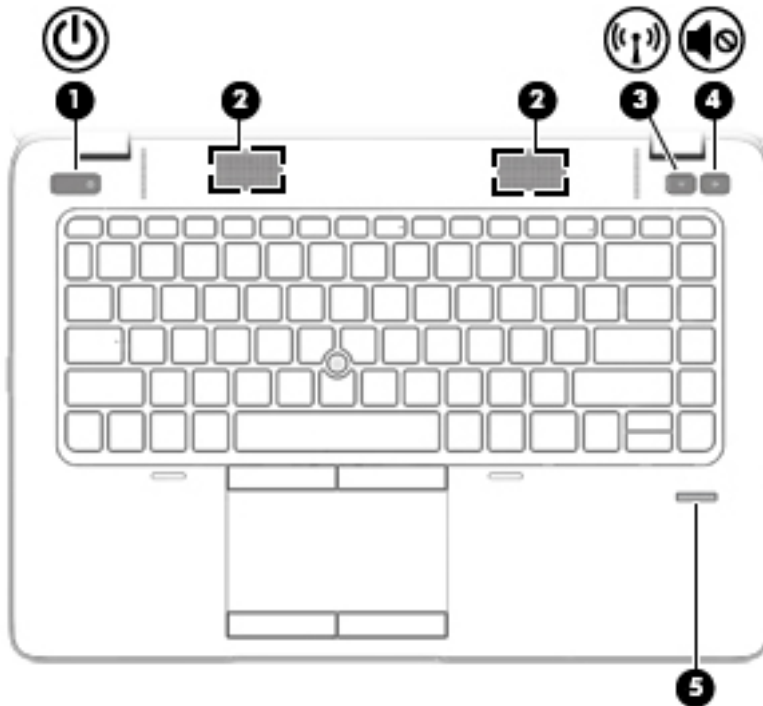

Component	Description
(1)  Power light	<ul style="list-style-type: none"> <li>On: The computer is on.</li> <li>Blinking: The computer is in the Sleep state.</li> <li>Off: The computer is off.</li> </ul>
(2) Caps lock light	On: Caps lock is on.
(3) TouchPad light	<ul style="list-style-type: none"> <li>On: The TouchPad is off.</li> <li>Off: The TouchPad is on.</li> </ul> (Select models only.)
(4)  Microphone mute light	<ul style="list-style-type: none"> <li>Amber: microphone sound is off.</li> <li>Off: microphone sound is on.</li> </ul>
(5) Num lock light	On: Num lock is on.
(6)  Wireless light	<ul style="list-style-type: none"> <li>White: An integrated wireless device, such as a wireless local area network (WLAN) device and/or a Bluetooth device, is on.</li> <li>Amber: All wireless devices are off.</li> </ul>
(7)  Mute light	<ul style="list-style-type: none"> <li>Amber: Computer sound is off.</li> <li>Off: Computer sound is on.</li> </ul>

## Buttons, speakers, and fingerprint reader (select models only)





Component	Description
<b>(1)</b>  Power button	<ul style="list-style-type: none"> <li>When the computer is off, press the button to turn on the computer.</li> <li>When the computer is on, press the button briefly to initiate Sleep.</li> <li>When the computer is in the Sleep state, press the button briefly to exit Sleep.</li> <li>When the computer is in Hibernation, press the button briefly to exit Hibernation.</li> </ul> <p><b>CAUTION:</b> Pressing and holding down the power button will result in the loss of unsaved information.</p> <p>If the computer has stopped responding and operating system shutdown procedures are ineffective, press and hold the power button for at least 5 seconds to turn off the computer.</p> <p>To learn more about your power settings:</p> <p><b>Windows 8.1:</b></p> <p>From the Start screen, type <code>power</code>, select <b>Settings</b>, and then select <b>Power Options</b>.</p> <p><b>Windows 7:</b></p> <p>Select <b>Start &gt; Control Panel &gt; System and Security &gt; Power Options</b>.</p>
<b>(2)</b> Speakers (2)	Produce sound.

Component		Description
(3)	 Wireless button	Turns the wireless feature on or off but does not establish a wireless connection.
(4)	 Volume mute button	Mutes and restores speaker sound.
(5)	Fingerprint reader (select models only)	Allows a fingerprint logon to Windows, instead of a password logon.

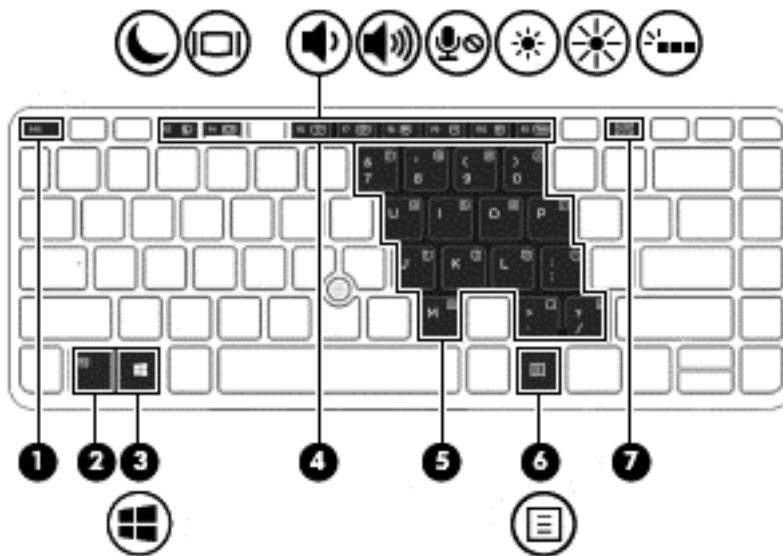

## Keys







Component	Description
(1) <a href="#">esc</a> key	(Windows only) Displays system information when pressed in combination with the <a href="#">fn</a> key.
(2) <a href="#">fn</a> key	Executes frequently used system functions when pressed in combination with a function key, the <a href="#">num lk</a> key, or the <a href="#">esc</a> key.
(3)  Windows key	<p><b>Windows 8.1:</b></p> <p>Returns you to the Start screen from an open app or the Windows desktop.</p> <p><b>NOTE:</b> Pressing the Windows key again will return you to the previous screen.</p> <p><b>Windows 7:</b></p> <p>Displays the Windows Start menu.</p> <p><b>Ubuntu:</b></p> <p>Displays the operating system menu.</p>
(4) Function keys	Execute frequently used system functions when pressed in combination with the <a href="#">fn</a> key.
(5) Embedded numeric keypad	<p>When the keypad is turned on, it can be used like an external numeric keypad.</p> <p>Each key on the keypad performs the function indicated by the icon in the upper-right corner of the key.</p>

Component	Description
(6)  Applications key	<p><b>Windows 8.1:</b></p> <p>Displays options for a selected object.</p> <p><b>Windows 7 and Ubuntu:</b></p> <p>Displays a shortcut menu for items beneath the cursor.</p>
(7) <a href="#">num lk key</a>	Turns the embedded numeric keypad on and off when pressed in combination with the <a href="#">fn</a> key.





## Front

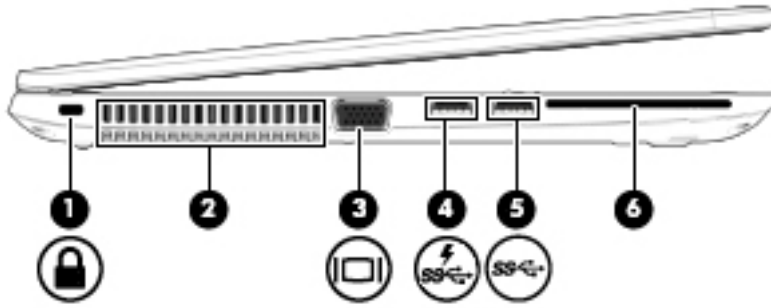

Component	Description
(1)  Wireless light	<ul style="list-style-type: none"> <li>White: An integrated wireless device, such as a wireless local area network (WLAN) device and/or a Bluetooth device, is on.</li> <li>Amber: All wireless devices are off.</li> </ul>
(2)  Power light	<ul style="list-style-type: none"> <li>On: The computer is on.</li> <li>Blinking: The computer is in the Sleep state.</li> <li>Off: The computer is off.</li> </ul>
(3)  AC adapter/Battery light	<ul style="list-style-type: none"> <li>White: The computer is connected to external power and the battery is charged from 90 to 99 percent.</li> <li>Amber: The computer is connected to external power and the battery is charged from 0 to 90 percent.</li> <li>Blinking amber: A battery that is the only available power source has reached a low battery level. When the battery reaches a critical battery level, the battery light begins blinking rapidly.</li> <li>Off: The battery is fully charged.</li> </ul>
(4)  Hard drive light	<ul style="list-style-type: none"> <li>Blinking white: The hard drive is being accessed.</li> <li>Amber: HP 3D DriveGuard has temporarily parked the hard drive.</li> </ul>





# Left

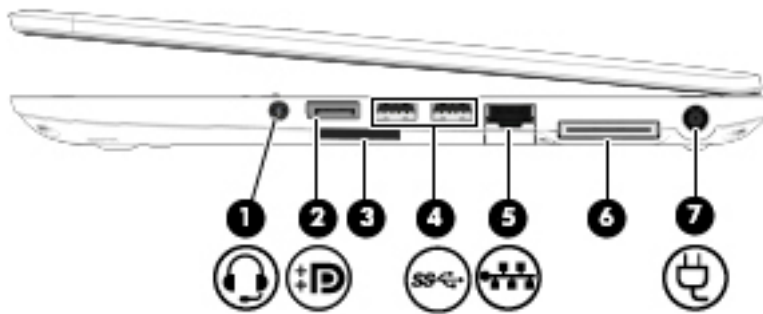

Component	Description
<b>(1)</b>  Security cable slot	Attaches an optional security cable to the computer.  <b>NOTE:</b> The security cable is designed to act as a deterrent, but it may not prevent the computer from being mishandled or stolen.
<b>(2)</b> Vent	Enables airflow to cool internal components.  <b>NOTE:</b> The computer fan starts up automatically to cool internal components and prevent overheating. It is normal for the internal fan to cycle on and off during routine operation.
<b>(3)</b>  External monitor port	Connects an external VGA monitor or projector.
<b>(4)</b>  USB 3.0 charging port	Connects optional USB 3.0 devices and provides enhanced USB power performance. The USB charging port can also charge select models of cell phones and MP3 players, even when the computer is off.
<b>(5)</b>  USB 3.0 port	Connects optional USB 3.0 devices and provide enhanced USB power performance.
<b>(6)</b> Smart card reader	Supports optional smart cards.

## Right





Component	Description
(1) 	<p>Audio-out (headphone) jack/Audio-in (microphone) jack</p> <p>Produces sound when connected to optional powered stereo speakers, headphones, earbuds, a headset, or television audio. Also connects an optional headset microphone.</p> <p><b>WARNING!</b> To reduce the risk of personal injury, adjust the volume before putting on headphones, earbuds, or a headset. For additional safety information, see the <i>Regulatory, Safety, and Environmental Notices</i>.</p> <p><b>NOTE:</b> When a device is connected to the jack, the computer speakers are disabled.</p> <p><b>NOTE:</b> Be sure that the device cable has a 4-conductor connector that supports both audio-out (headphone) and audio-in (microphone).</p>
(2) 	<p>DisplayPort</p> <p>Connects an optional digital display device, such as a high-performance monitor or projector.</p>
(3)	<p>Memory card reader</p> <p>Reads data from and writes data to memory cards such as Secure Digital (SD).</p>
(4) 	<p>USB 3.0 ports (2)</p> <p>Connect optional USB 3.0 devices and provide enhanced USB power performance.</p>
(5) 	<p>RJ-45 (network) jack</p> <p>Connects a network cable.</p>
(6)	<p>Docking connector</p> <p>Connects an optional docking device.</p>
(7) 	<p>Power connector</p> <p>Connects an AC adapter.</p>

# Bottom

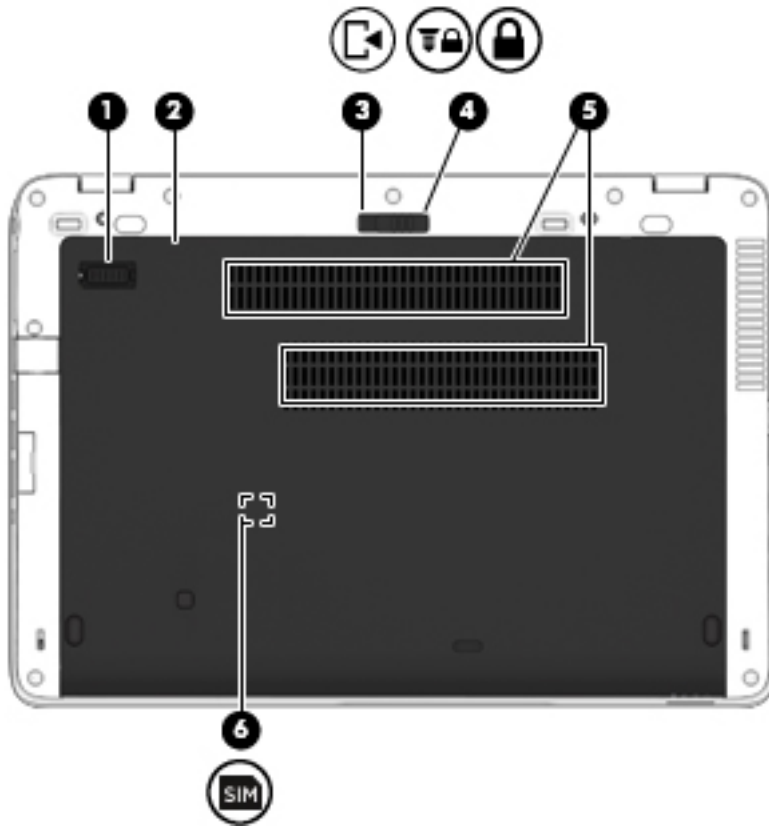

 **NOTE:** Your computer bottom will resemble one of the examples shown below. Refer to the illustration that most closely matches your computer.

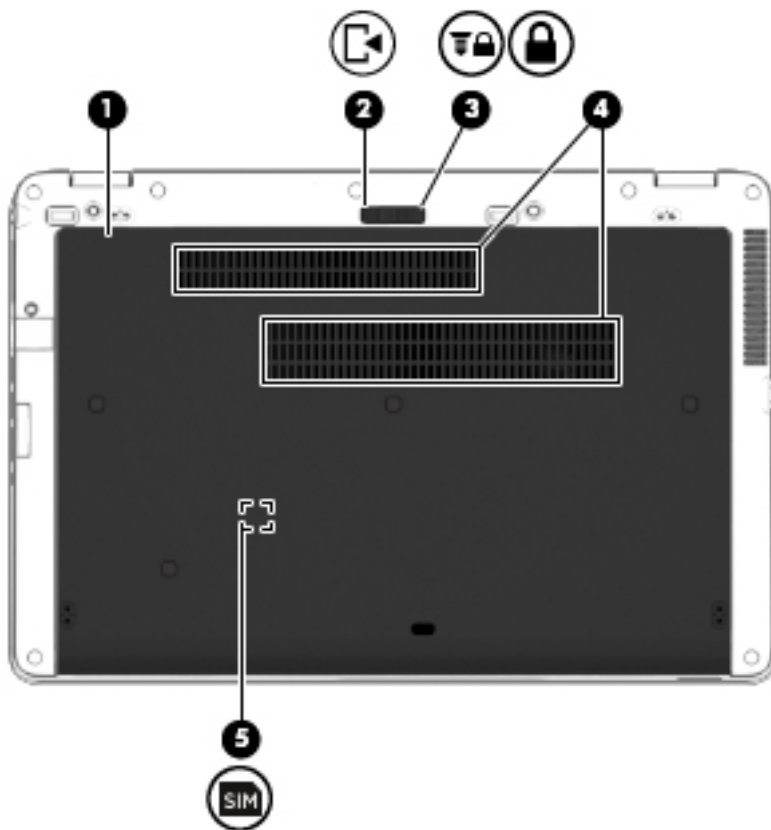

Component	Description
(1)	Accessory battery connector Connects an optional accessory battery.
(2)	Service door Provides access to the hard drive bay, the wireless LAN (WLAN) module slot, the WWAN module slot, and the memory module slots.  <b>CAUTION:</b> To prevent an unresponsive system, replace the wireless module only with a wireless module authorized for use in the computer by the governmental agency that regulates wireless devices in your country or region. If you replace the module and then receive a warning message, remove the module to restore computer functionality, and then contact support.  <b>Windows 8.1:</b>  On the Start screen, select the <b>HP Support Assistant</b> app.  <b>Other operating systems:</b>  Go to <a href="http://www.hp.com/support">http://www.hp.com/support</a> , select your country or region, and follow the on-screen instructions.
(3)	Service door release latch Releases the service door on the computer.

Component	Description
(4)  Service door release lock	Locks service door.
(5) Vents (2)	Enable airflow to cool internal components.  <b>NOTE:</b> The computer fan starts up automatically to cool internal components and prevent overheating. It is normal for the internal fan to cycle on and off during routine operation.
(6)  SIM slot (select models only)	Supports a wireless subscriber identity module (SIM). The SIM slot is located inside the battery bay.



Component	Description		
(1)	Service door	<p>Provides access to the hard drive bay, the wireless LAN (WLAN) module slot, the WWAN module slot, and the memory module slots.</p> <p><b>CAUTION:</b> To prevent an unresponsive system, replace the wireless module only with a wireless module authorized for use in the computer by the governmental agency that regulates wireless devices in your country or region. If you replace the module and then receive a warning message, remove the module to restore computer functionality, and then contact support.</p> <p><b>Windows 8.1:</b></p> <p>On the Start screen, select the <b>HP Support Assistant</b> app.</p> <p><b>Other operating systems:</b></p> <p>Go to <a href="http://www.hp.com/support">http://www.hp.com/support</a>, select your country or region, and follow the on-screen instructions.</p>	
(2)		Service door release latch	Releases the service door on the computer.
(3)		Service door release lock	Locks the service door.
(4)	Vents (2)	Enable airflow to cool internal components.	<p><b>NOTE:</b> The computer fan starts up automatically to cool internal components and prevent overheating. It is normal for the internal fan to cycle on and off during routine operation.</p>
(5)		SIM slot (select models only)	Supports a wireless subscriber identity module (SIM). The SIM slot is located inside the battery bay.

## Service Label

When ordering parts or requesting information, provide the computer serial number and model number provided on the label. It is necessary to remove the battery to obtain these numbers. See [Battery on page 49](#) for battery removal instructions.



Item	Component	Description
(1)	Serial number (s/n)	This is an alphanumeric identifier that is unique to each product.
(2)	Product name	This is the product name affixed to the front of the computer.
(3)	Warranty period	This number describes the duration of the warranty period for the computer.



---

## 3 Illustrated parts catalog



**NOTE:** HP continually improves and changes product parts. For complete and current information on supported parts for your computer, go to <http://partsurfer.hp.com>, select your country or region, and then follow the on-screen instructions.

---

# Computer major components

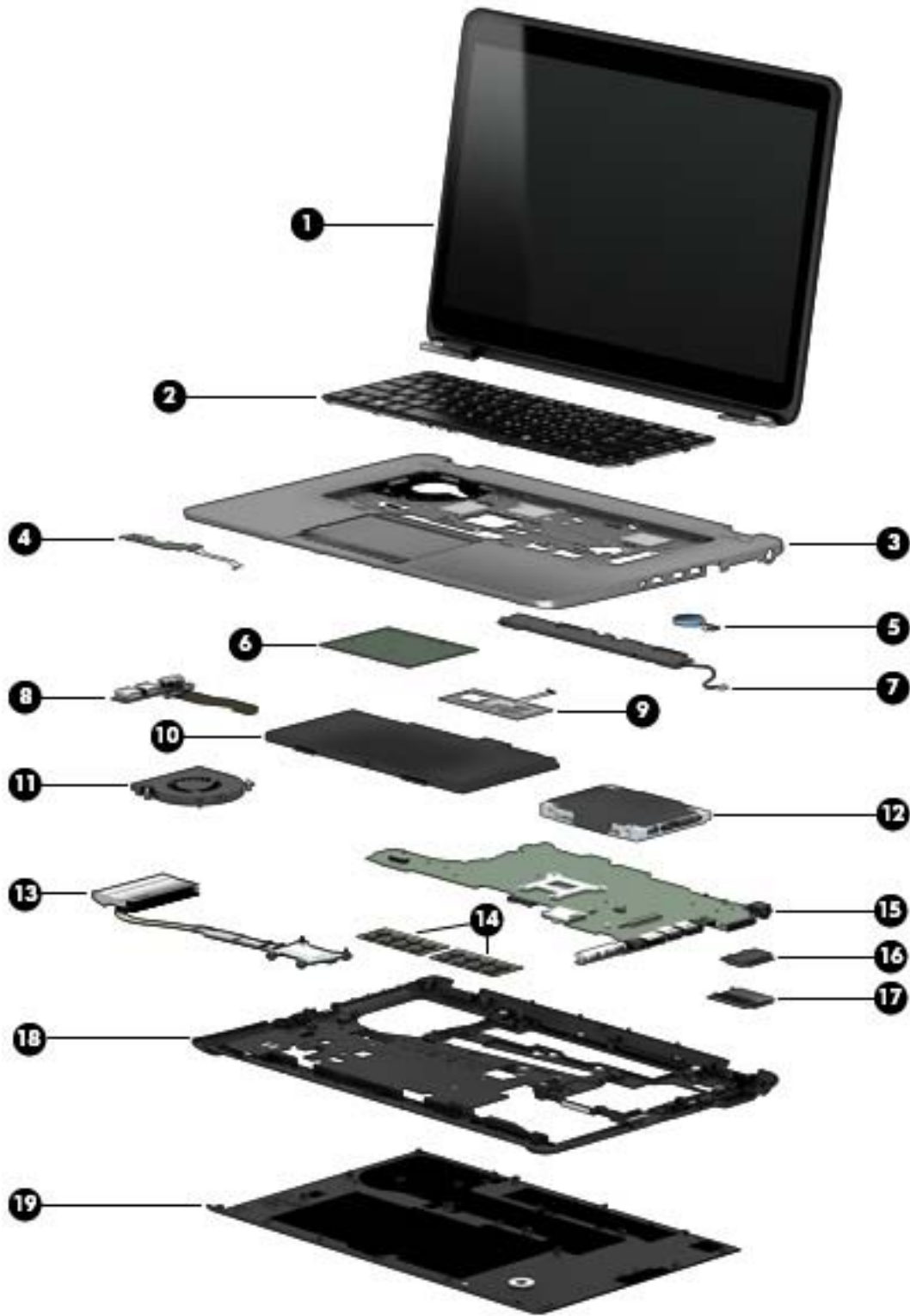



**IMPORTANT:** For system board (15) replacement on serial numbers xxx501xxxx and below, use the conversion kit (see product description for “(Gold Conversion Kit)” in the section marked 15a of the table below). For serial numbers xxx502xxxx and above, use the standard spare kit (see product description for “(Gold)”).

Item	Component	Spare part number
(1)	<b>Display assembly:</b> Non-touch display assemblies are spared at the subcomponent level only. For more display assembly spare part information, see <a href="#">Display assembly subcomponents on page 26</a> .	
	Touch screen display assemblies are only spared as whole units.	
	15 in, FHD,AG SVA, slim for use in HP EliteBook 755 models	774990-001
	14 in, FHD, UWVA, slim, for use in HP EliteBook 745 models	777325-001
(2)	<b>Keyboard</b> , with pointing stick, (includes cables)	
	<b>NOTE:</b> For a detailed list of available keyboards, see <a href="#">Sequential part number listing on page 33</a> .	
	Backlit	776475-xx1
	No backlight	776474-xx1
(3)	<b>Top cover</b> (includes TouchPad):	
	For use on HP EliteBook 745 models	779683-001
	For use on HP EliteBook 755 models	779687-001
(4)	<b>Power button board</b>	
	For use on HP EliteBook 745 models	730959-001
	For use on HP EliteBook 755 models	730822-001
(5)	<b>RTC battery</b>	665733-001
(6)	<b>Card reader board</b>	
	For use on HP EliteBook 745 models	768791-001
	For use on HP EliteBook 755 models	773960-001
(7)	<b>Speaker assembly</b> (includes cable)	730798-001
(8)	<b>VGA/USB board</b>	
	For use in HP EliteBook 745 models	768792-001
	For use in HP EliteBook 755 models	773961-001
(9)	<b>Fingerprint reader board</b> (includes cable, bracket, and insulator)	
	For use in HP EliteBook 745 models	730956-001
	For use in HP EliteBook 755 models	730817-001
(10)	<b>Battery</b> (Li ion):	
	3 cell, 50 Wh, 4.5 Ah	717376-001
	3 cell, 24 Wh, 2.4 Ah	717375-001
(11)	<b>Fan</b> (includes cable)	730792-001
(12)	<b>Hard drive</b>	

<b>Item</b>	<b>Component</b>	<b>Spare part number</b>
	<b>2.5 in HDD, SATA, 9.5 mm</b> (does not include the hard drive bracket or screws)	
	1 TB, 7200 rpm	766644-001
	<b>2.5 in HDD, SATA, 7 mm</b> (does not include the hard drive bracket or screws)	
	500 GB, 7200 rpm, SED	703268-001
	500 GB, 7200 rpm	703267-001
	500 GB, 5400 rpm, FIPS	730946-001
	320 GB, 7200 rpm	634862-001
	<b>Hard Drive Hardware Kit</b> (not illustrated, includes hard drive bracket and screws)	730793-001
	<b>2.5 in SSD</b> (includes hard drive bracket or screws)	
	256 GB, SATA III, Self-Encrypting Drive (SED), supporting Opal 2.0 Storage Specification	768807-001
	240 GB, SATA III	768805-001
	180 GB, SATA III, SED, supporting Opal 1.0	768804-001
	180 GB, SATA III	768803-001
	128 GB, SATA III	768802-001
<b>(13)</b>	<b>Heat sink</b> (includes replacement thermal material):	
	For use only on HP EliteBook 745 models	768790-001
	For use only on HP EliteBook 755 models	773959-001
<b>(14)</b>	<b>Memory modules</b> (PC3L, 12800, 1600 MHz):	
	8 GB memory module	693374-001
	4 GB memory module	691740-001
<b>(15)</b>	<b>System board</b> (includes replacement thermal material):	
	For use on models with AMD A6-7050B G2 processor for use with the Windows 8.1 Professional operating system (Gold)	802541-601
	For use on models with AMD A6-7050B G2 processor for use with the Windows 8.1 Standard operating system (Gold)	802541-501
	For use on models with AMD A6-7050B G2 processor for use with models without the Windows 8.1 operating system (Gold)	802541-001
	For use on models with AMD A8-7150B G2 processor for use with the Windows 8.1 Professional operating system (Gold)	802542-601
	For use on models with AMD A8-7150B G2 processor for use with the Windows 8.1 Standard operating system (Gold)	802542-501
	For use on models with AMD A8-7150B G2 processor for use with models without the Windows 8.1 operating system (Gold)	802542-001
	For use on models with AMD A10-7350B G2 processor for use with the Windows 8.1 Professional operating system (Gold)	802543-601
	For use on models with AMD A10-7350B G2 processor for use with the Windows 8.1 Standard operating system (Gold)	802543-501

Item	Component	Spare part number
	For use on models with AMD A10-7350B G2 processor for use with models without the Windows 8.1 operating system (Gold)	802543-001
<b>(15)</b>	<b>System board (Gold Conversion Kits)</b> (includes replacement thermal material):	
	For use on models with AMD A6-7050B G2 processor for use with the Windows 8.1 Professional operating system (Gold Conversion Kit)	802541-6C1
	For use on models with AMD A6-7050B G2 processor for use with the Windows 8.1 Standard operating system (Gold Conversion Kit)	802541-5C1
	For use on models with AMD A6-7050B G2 processor for use with models without the Windows 8.1 operating system (Gold Conversion Kit)	802541-0C1
	For use on models with AMD A8-7150B G2 processor for use with the Windows 8.1 Professional operating system (Gold Conversion Kit)	802542-6C1
	For use on models with AMD A8-7150B G2 processor for use with the Windows 8.1 Standard operating system (Gold Conversion Kit)	802542-5C1
	For use on models with AMD A8-7150B G2 processor for use with models without the Windows 8.1 operating system (Gold Conversion Kit)	802542-0C1
	For use on models with AMD A10-7350B G2 processor for use with the Windows 8.1 Professional operating system (Gold Conversion Kit)	802543-6C1
	For use on models with AMD A10-7350B G2 processor for use with the Windows 8.1 Standard operating system (Gold Conversion Kit)	802543-5C1
	For use on models with AMD A10-7350B G2 processor for use with models without the Windows 8.1 operating system (Gold Conversion Kit)	802543-0C1
<b>(16)</b>	<b>WLAN module:</b>	
	Qualcomm Atheros AR9485 802.11 b/g/n 1x1 WiFi Adaptor (select models only)	675794-001
	Broadcom BCM4352 802.11ac 2x2 Wi-Fi + Bluetooth 4.0 combo (select models only)	724935-001
	Broadcom BCM943228HMB WiDi 802.11 a/b/g/n 2x2 Wi-Fi + Bluetooth 4.0 combo (select models only)	730668-001
<b>(17)</b>	<b>WWAN module:</b>	
	HP lt4211 LTE/EV-DO/HSPA+ 4G Mobile Broadband Module	748021-001
	HP lt4112 LTE/HSPA+ 4G Mobile Broadband Module	740011-001
	HP hs3110 HSPA+ Mobile Broadband Module	748599-001
<b>(18)</b>	<b>Internal base enclosure</b> (includes RJ-45 door with spring)	
	For use only on HP EliteBook 745 models	779684-001
	For use only on HP EliteBook 755 models	779688-001
	<b>Rubber Kit</b> (not illustrated; includes rubber screw covers):	730796-001
<b>(19)</b>	<b>Service door</b>	
	For use only on HP EliteBook 745 models	768793-001
	For use only on HP EliteBook 755 models	773962-001

# Display assembly subcomponents

## HP EliteBook 745 models

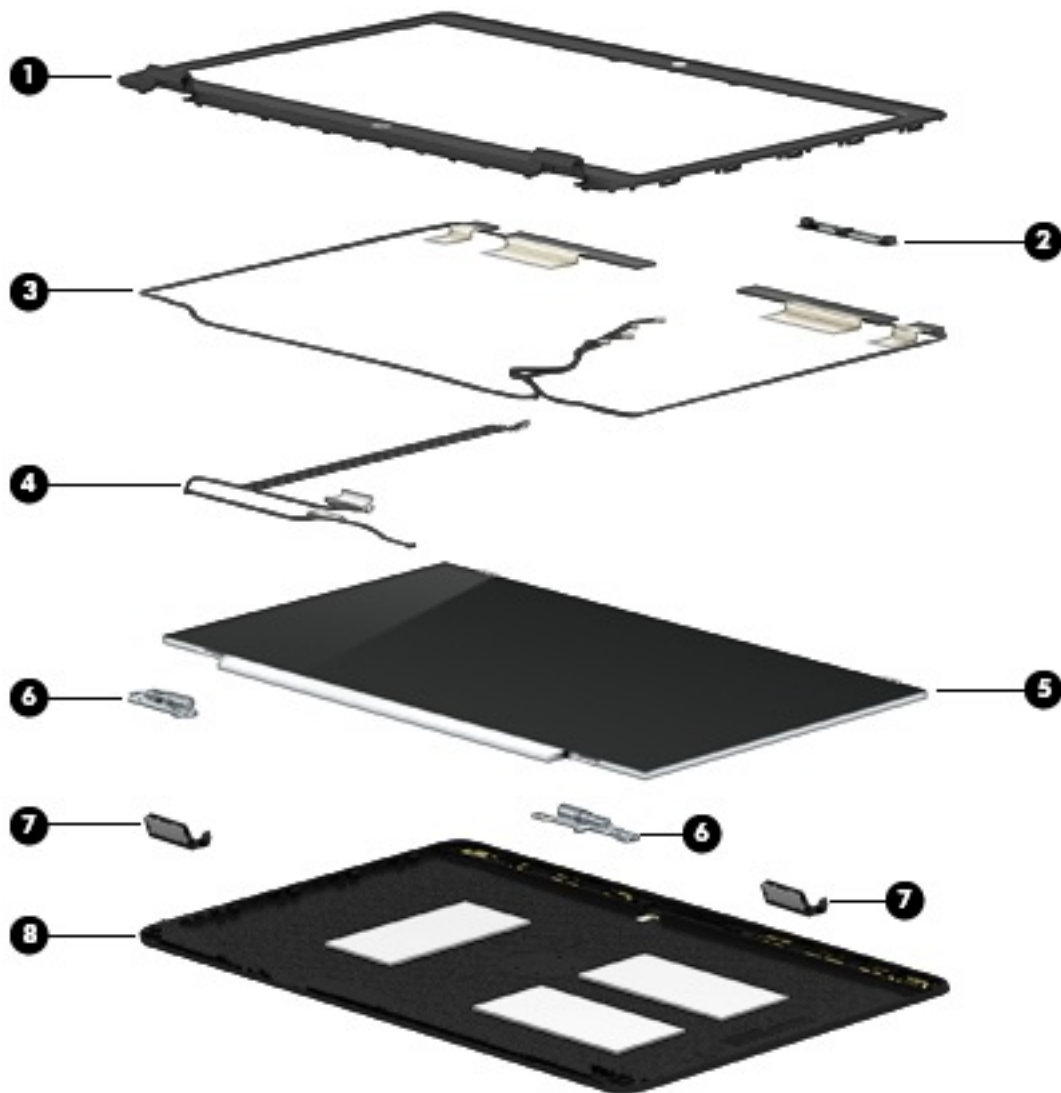

Item	Component	Spare part number
(1)	<b>Display bezel:</b>	768808-001
(2)	<b>Webcam</b>	777326-001
	<b>Microphone module</b> (not illustrated)	730795-001
(3)	<b>Antenna kit</b> (includes cables and transceivers for WLAN and WWAN)	780080-001
(4)	<b>Display panel cable</b> (includes webcam/microphone module cable)	730954-001
(5)	<b>(35.6 cm) 14.0 in, LED, AntiGlare display panel:</b>	
	HD, SVA (1366×768), 200 nits (cd/m <sup>2</sup> ), flat	768809-001
	HD+, SVA (1920×1080), 250 nits (cd/m <sup>2</sup> ), flat	768810-001

<b>Item</b>	<b>Component</b>	<b>Spare part number</b>
	FHD, SVA (1920×1080) 300 nits (cd/m <sup>2</sup> ), slim	768811-001
	<b>Display Hinge Kit</b> (includes left and right hinges and hinge covers)	730957-001
<b>(6)</b>	Left and right hinges	
<b>(7)</b>	Left and right hinge covers	
<b>(8)</b>	<b>Display enclosure</b>	779682-001

## HP EliteBook 755 models

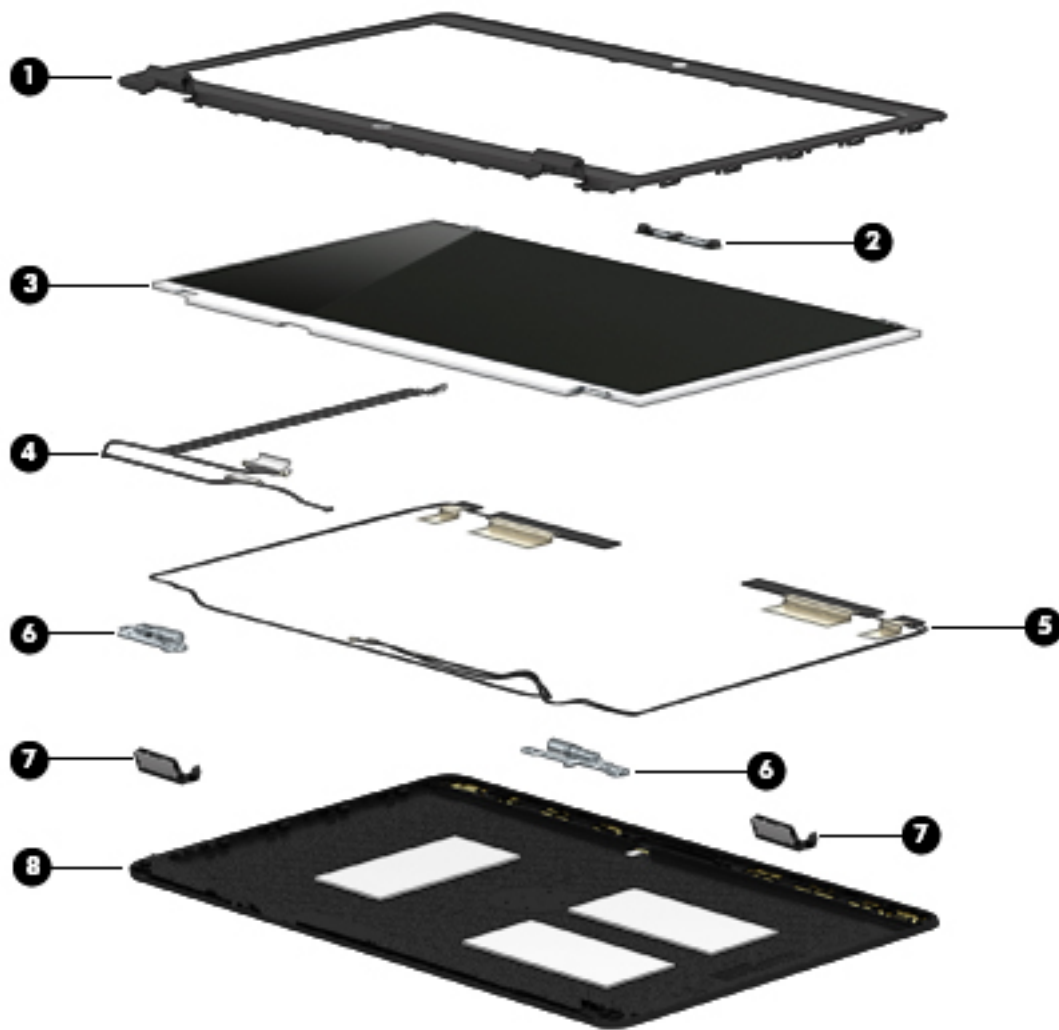

Item	Component	Spare part number
(1)	<b>Display bezel</b>	773963-001
(2)	<b>Webcam</b>	777326-001
	<b>Microphone module</b> (not illustrated)	730795-001
(3)	<b>(39.6 cm) 15.6 in, LED, AntiGlare display panel:</b>	
	HD AG SVA 45% CG 200 nits (cd/m <sup>2</sup> ) eDP 1.2 flat (1366x768)	777834-001
	FHD AG SVA 60% CG 300 nits (cd/m <sup>2</sup> ) eDP 1.2 slim (1920x1080)	777835-001
(4)	<b>Display panel cable</b> (includes webcam/microphone module cable)	730801-001
(5)	<b>Antenna kit</b> (includes cables and transceivers for WLAN and WWAN)	780081-001
	<b>Display Hinge Kit</b> (includes left and right hinges and hinge covers):	730819-001
(6)	Left and right hinges	



<b>Item</b>	<b>Component</b>	<b>Spare part number</b>
<b>(7)</b>	Left and right hinge covers	
<b>(8)</b>	<b>Display enclosure</b>	779686-001

## Mass storage devices



Item	Description	Spare part number
(1)	<b>Hard Drive Hardware Kit</b> , includes bracket	730793-001
(2)	<b>Hard drive</b> (does not include hard drive bracket or screws):	
	<b>2.5 in HDD, SATA, 9.5 mm</b> (does not include the hard drive bracket or screws)	
	1 TB, 7200 rpm	766644-001
	<b>2.5 in HDD, SATA, 7 mm</b> (does not include the hard drive bracket or screws)	
	500 GB, 7200 rpm, SED	703268-001
	500 GB, 7200 rpm	703267-001
	500 GB, 5400 rpm, FIPS	730946-001
	320 GB, 7200 rpm,	634862-001
	<b>2.5 in SSD</b> (includes hard drive bracket and screws):	
	256 GB, SATA III, SED, supporting Opal 2.0	768807-001
	240 GB, SATA III	768805-001
	180 GB, SATA III, SED, supporting Opal 1.0	768804-001
	180 GB, SATA III	768803-001
	128 GB, SATA III	768802-001

## Plastics Kit



Item	Description	Spare part number
	<b>Plastics Kit</b> for use only on HP EliteBook 745 models	730958-001
	<b>Plastics Kit</b> for use only on HP EliteBook 755 models	730802-001
(1)	SD card insert, illustrated	
(2)	Fingerprint reader insert	
(3)	RJ-45 spring	
(4)	RJ-45 door	

## Miscellaneous parts

Component	Spare part number
<b>AC adapter:</b>	
45 W HP Smart AC adapter (non-PFC, 7.4 mm RC NSLIM)	744893-001
45 W HP Smart AC adapter (non-PFC, RC 2 prong), for use in HP EliteBook 755 models	742437-001
65 W HP Smart AC travel adapter (non-PFC)	693716-001
65 W HP Smart AC adapter (RC/V, EM) for use in India and the People's Republic of China	693710-001
<b>Power cord (3-pin, black, 1.83 m):</b>	
For use in Argentina	490371-D01
For use in Australia	490371-011
For use in Brazil	490371-202
For use in Denmark	490371-081
For use in Europe	490371-021
For use in India	490371-D61
For use in Italy	490371-061
For use in Japan	490371-291
For use in North America	490371-001
For use in the People's Republic of China	490371-AA1
For use in South Africa	490371-AR1
For use in South Korea	490371-AD1
For use in Switzerland	490371-111
For use in Taiwan	490371-AB1
For use in Thailand	490371-201
For use in the United Kingdom and Singapore	490371-031
<b>Power cord 3-pin, black, 1.0 m</b>	
For use in Argentina	755530-D01
For use in Australia	755530-011
For use in Brazil	755530-202
For use in India	755530-D61
For use in Israel	755530-BB1
For use in Japan	755530-291
For use in North America	755530-001
For use in the People's Republic of China	755530-AA1
For use in South Africa	755530-AR1
For use in Taiwan	755530-AB1

Component	Spare part number
For use in Thailand	755530-201
For use in the United Kingdom and Singapore	755530-031
<b>Power cord</b> 2-pin, black, 1.0 m, for use in Japan	762689-291

## Sequential part number listing

CSR flag designations:

A = Mandatory

B = Optional

C = Service technician recommended

N = Non-user replaceable



**IMPORTANT:** For system board replacement on serial numbers xxx501xxxx and below, you must use a conversion kit (see product description for “(Gold Conversion Kit)”). For serial numbers xxx502xxxx and above, use the standard spare kit (see product description for “(Gold)”).

Spare part number	CSR flag	Description
490371-001	A	Power cord for use on all computer models in North America (3-pin, black, 1.83-m)
490371-011	A	Power cord for use on all computer models in Australia (3-pin, black, 1.83-m)
490371-021	A	Power cord for use on all computer models in Europe (3-pin, black, 1.83-m)
490371-031	A	Power cord for use on all computer models in the United Kingdom and Singapore (3-pin, black, 1.83-m)
490371-061	A	Power cord for use on all computer models in Italy (3-pin, black, 1.83-m)
490371-081	A	Power cord for use on all computer models in Denmark (3-pin, black, 1.83-m)
490371-111	A	Power cord for use on all computer models in Switzerland (3-pin, black, 1.83-m)
490371-201	A	Power cord for use on all computer models in Thailand (3-pin, black, 1.83-m)
490371-202	A	Power cord for use on all computer models in Brazil (3-pin, black, 1.83-m)
490371-291	A	Power cord for use on all computer models in Japan (3-pin, black, 1.83-m)
490371-AA1	A	Power cord for use on all computer models in the People's Republic of China (3-pin, black, 1.83-m)
490371-AB1	A	Power cord for use on all computer models in Taiwan (3-pin, black, 1.83-m)
490371-AD1	A	Power cord for use on all computer models in South Korea (3-pin, black, 1.83-m)
490371-AR1	A	Power cord for use on all computer models in South Africa (3-pin, black, 1.83-m)
490371-D01	A	Power cord for use on all computer models in Argentina (3-pin, black, 1.83-m)
490371-D61	A	Power cord for use on all computer models in India (3-pin, black, 1.83-m)
634862-001	A	320 GB, 7200 rpm, 7 mm hard drive (does not include hard drive bracket or screws)
665733-001	N	RTC battery

<b>Spare part number</b>	<b>CSR flag</b>	<b>Description</b>
675794-001	A	Qualcomm Atheros AR9485 802.11 b/g/n 1x1 WiFi Adaptor (select models only)
691740-001	A	4 GB memory module (PC3L, 12800, 1600 MHz)
693374-001	A	8 GB memory module (PC3L, 12800, 1600 MHz)
693710-001	A	65 W HP Smart AC adapter (RC/V, EM) for use in India and the People's Republic of China
693716-001	A	65 W HP Smart AC travel adapter (non-PFC)
703267-001	A	500 GB, 7200 rpm, 7 mm hard drive (does not include hard drive bracket or screws)
703268-001	A	500 GB, 7200 rpm, 7 mm, SED hard drive (does not include hard drive bracket or screws)
717375-001	A	3 cell, 24 Wh, 2.40 Ah, Li-ion battery
717376-001	A	3 cell, 50 Wh, 4.50 Ah, Li-ion battery
724935-001	A	Broadcom BCM4352 802.11ac 2x2 Wi-Fi + Bluetooth 4.0 combo adapter (select models only)
730668-001	A	Broadcom BCM943228HMB WiDi 802.11 a/b/g/n 2x2 Wi-Fi + Bluetooth 4.0 combo (select models only)
730792-001	C	Fan (includes cable)
730793-001	A	Hard Drive Hardware Kit (includes the hard drive bracket and screws)
730795-001	N	Microphone module
730796-001	A	Rubber Kit (includes rubber screw covers)
730797-001	N	Screw Kit
730798-001	N	Speaker assembly (includes cable)
730801-001	N	Display panel cable for use only on HP EliteBook 755 models
730802-001	C	Plastics Kit for use only on HP EliteBook 755 models (includes SD card insert, RJ-45 door, fingerprint reader insert, and RJ-45 spring)
730817-001	N	Fingerprint reader assembly for use in HP EliteBook 755 models (includes cable, bracket, and insulator)
730819-001	N	Display Hinge Kit for use only on HP EliteBook 755 models (includes left and right hinges and hinge covers)
730822-001	N	Power button board for use in HP EliteBook 755 models
730946-001	A	500 GB, 5400 rpm, 7 mm, FIPS hard drive (does not include hard drive bracket or screws)
730954-001	N	Display panel cable for use only on HP EliteBook 745 models
730956-001	N	Fingerprint reader assembly for use in HP EliteBook 745 models (includes cable, bracket, and insulator)
730957-001	N	Display Hinge Kit for use only on HP EliteBook 745 models (includes left and right hinges and hinge covers)
730958-001	C	Plastics Kit for use only on HP EliteBook 745 models (includes SD card insert, RJ-45 door, fingerprint reader insert, and RJ-45 spring)
730959-001	N	Power button board for use in HP EliteBook 745 models
777325-001	N	Display assembly, 14 in, FHD, for use in HP EliteBook 745 models
740011-001	B	HP lt4112 LTE/HSPA+ 4G Broadband Module
742437-001	A	45 W HP Smart AC adapter (non-PFC, RC 2 prong), for use in HP EliteBook 755 models

Spare part number	CSR flag	Description
744893-001	A	45 W HP Smart AC adapter (non-PFC, 7.4 mm RC NSLIM)
748021-001	B	HP lt4211 LTE/EV-DO/HSPA+ 4G Mobile Broadband Module
748599-001	B	HP hs3110 HSPA+ Mobile Broadband Module
755530-001	A	Power cord for use on all computer models in North America (3-pin, black, 1.0 m)
755530-011	A	Power cord for use on all computer models in Australia (3-pin, black, 1.0 m)
755530-031	A	Power cord for use on all computer models in the United Kingdom and Singapore (3-pin, black, 1.0 m)
755530-201	A	Power cord for use on all computer models in Thailand (3-pin, black, 1.0 m)
755530-202	A	Power cord for use on all computer models in Brazil (3-pin, black, 1.0 m)
755530-291	A	Power cord for use on all computer models in Japan (3-pin, black, 1.0 m)
755530-AA1	A	Power cord for use on all computer models in the People's Republic of China (3-pin, black, 1.0 m)
755530-AB1	A	Power cord for use on all computer models in Taiwan (3-pin, black, 1.0 m)
755530-AR1	A	Power cord for use on all computer models in South Africa (3-pin, black, 1.0 m)
755530-BB1	A	Power cord for use on all computer models in Israel (3-pin, black, 1.0 m)
755530-D01	A	Power cord for use on all computer models in Argentina (3-pin, black, 1.0 m)
755530-D61	A	Power cord for use on all computer models in India (3-pin, black, 1.0 m)
755530-291	A	Power cord for use on all computer models in Japan (3-pin, black, 1.0 m)
762689-291	A	<b>Power cord</b> 2-pin, black, 1.0 m, for use in Japan
766644-001	A	1 TB, 7200 rpm, 9.5 mm hard drive (does not include hard drive bracket or screws)
768790-001	N	Heat sink for use only on HP EliteBook 745 models (includes replacement thermal material)
768791-001	C	Card reader board for use in HP EliteBook 745 models
768792-001	C	VGA/USB board for use in HP EliteBook 745 models
768793-001	A	Service door for use only on HP EliteBook 745 models
768802-001	A	Solid-state drive, 2.5 in, 128 GB, SATA III (includes hard drive bracket and screws)
768803-001	A	Solid-state drive, 2.5 in, 180 GB, SATA III (includes hard drive bracket and screws)
768804-001	A	Solid-state drive, 2.5 in, 180 GB, SATA III, SED, supporting Opal 1.0 (includes hard drive bracket and screws)
768805-001	A	Solid-state drive, 2.5 in, 240 GB, SATA III (includes hard drive bracket and screws)
768807-001	A	Solid-state drive, 2.5 in, 256 GB, SATA III, Self-Encrypting Drive (SED), supporting Opal 2.0 (includes hard drive bracket and screws)
768808-001	N	Display bezel for use only on HP EliteBook 745 models
768809-001	C	Raw display panel, <b>(35.6 cm)</b> 14.0 in LED, HD, AG, SVA (1366×768), flat, 200 nits (cd/m <sup>2</sup> )
768810-001	C	Raw display panel, <b>(35.6 cm)</b> 14.0 in LED, HD+, AG, SVA (1920×1080), flat, 250 nits (cd/m <sup>2</sup> )
768811-001	C	Raw display panel, <b>(35.6 cm)</b> 14.0 in LED, FHD, AG, SVA (1920×1080), slim, 300 nits (cd/m <sup>2</sup> )
773959-001	N	Heat sink for use only on HP EliteBook 755 models (includes replacement thermal material)

<b>Spare part number</b>	<b>CSR flag</b>	<b>Description</b>
773960-001	C	Card reader board for use in HP EliteBook 755 models
773961-001	C	VGA/USB board for use in HP EliteBook 755 models
773962-001	A	Service door for use only on HP EliteBook 755 models
773963-001	A	Display bezel for use only on HP EliteBook 755 models
774990-001	N	Display assembly, 15 in, FHD, for use in HP EliteBook 755 models
776474-001	B	Keyboard with pointing stick for use in the United States (includes keyboard cable and pointing stick cable)
776474-031	B	Keyboard with pointing stick for use in the United Kingdom and Singapore (includes keyboard cable and pointing stick cable)
776474-041	B	Keyboard with pointing stick for use in Germany (includes keyboard cable and pointing stick cable)
776474-051	B	Keyboard with pointing stick for use in France (includes keyboard cable and pointing stick cable)
776474-061	B	Keyboard with pointing stick for use in Italy (includes keyboard cable and pointing stick cable)
776474-071	B	Keyboard with pointing stick for use in Spain (includes keyboard cable and pointing stick cable)
776474-081	B	Keyboard with pointing stick for use in Denmark (includes keyboard cable and pointing stick cable)
776474-091	B	Keyboard with pointing stick for use in Norway (includes keyboard cable and pointing stick cable)
776474-131	B	Keyboard with pointing stick for use in Portugal (includes keyboard cable and pointing stick cable)
776474-141	B	Keyboard with pointing stick for use in Turkey (includes keyboard cable and pointing stick cable)
776474-151	B	Keyboard with pointing stick for use in Greece (includes keyboard cable and pointing stick cable)
776474-161	B	Keyboard with pointing stick for use in Latin America (includes keyboard cable and pointing stick cable)
776474-171	B	Keyboard with pointing stick for use in Saudi Arabia (includes keyboard cable and pointing stick cable)
776474-201	B	Keyboard with pointing stick for use in Brazil (includes keyboard cable and pointing stick cable)
776474-211	B	Keyboard with pointing stick for use in Hungary (includes keyboard cable and pointing stick cable)
776474-251	B	Keyboard with pointing stick for use in Russia (includes keyboard cable and pointing stick cable)
776474-261	B	Keyboard with pointing stick for use in Bulgaria (includes keyboard cable and pointing stick cable)
776474-271	B	Keyboard with pointing stick for use in Romania (includes keyboard cable and pointing stick cable)
776474-281	B	Keyboard with pointing stick for use in Thailand (includes keyboard cable and pointing stick cable)
776474-291	B	Keyboard with pointing stick for use in Japan (includes keyboard cable and pointing stick cable)
776474-A41	B	Keyboard with pointing stick for use in Belgium (includes keyboard cable and pointing stick cable)
776474-AB1	B	Keyboard with pointing stick for use in Taiwan (includes keyboard cable and pointing stick cable)
776474-AD1	B	Keyboard with pointing stick for use in South Korea (includes keyboard cable and pointing stick cable)
776474-B31	B	Keyboard with pointing stick for use in the Netherlands (includes keyboard cable and pointing stick cable)
776474-B71	B	Keyboard with pointing stick for use in Sweden and Finland (includes keyboard cable and pointing stick cable)
776474-BA1	B	Keyboard with pointing stick for use in Slovenia (includes keyboard cable and pointing stick cable)



<b>Spare part number</b>	<b>CSR flag</b>	<b>Description</b>
776474-BB1	B	Keyboard with pointing stick for use in Israel (includes keyboard cable and pointing stick cable)
776474-BG1	B	Keyboard with pointing stick for use in Switzerland (includes keyboard cable and pointing stick cable)
776474-D61	B	Keyboard with pointing stick for use in India (includes keyboard cable and pointing stick cable)
776474-DB1	B	Keyboard with pointing stick for use in Canada (includes keyboard cable and pointing stick cable)
776474-DD1	B	Keyboard with pointing stick for use in Iceland (includes keyboard cable and pointing stick cable)
776474-FL1	B	Keyboard with pointing stick for use in the Czech Republic and Slovakia (includes keyboard cable and pointing stick cable)
776474-FP1	B	Keyboard with pointing stick for use in Northwest Africa (includes keyboard cable and pointing stick cable)
776475-001	B	Keyboard, backlit, with pointing stick for use in the United States (includes keyboard cable and pointing stick cable)
776475-031	B	Keyboard, backlit, with pointing stick for use in the United Kingdom and Singapore (includes keyboard cable and pointing stick cable)
776475-041	B	Keyboard, backlit, with pointing stick for use in Germany (includes keyboard cable and pointing stick cable)
776475-051	B	Keyboard, backlit, with pointing stick for use in France (includes keyboard cable and pointing stick cable)
776475-061	B	Keyboard, backlit, with pointing stick for use in Italy (includes keyboard cable and pointing stick cable)
776475-071	B	Keyboard, backlit, with pointing stick for use in Spain (includes keyboard cable and pointing stick cable)
776475-081	B	Keyboard, backlit, with pointing stick for use in Denmark (includes keyboard cable and pointing stick cable)
776475-091	B	Keyboard, backlit, with pointing stick for use in Norway (includes keyboard cable and pointing stick cable)
776475-131	B	Keyboard, backlit, with pointing stick for use in Portugal (includes keyboard cable and pointing stick cable)
776475-141	B	Keyboard, backlit, with pointing stick for use in Turkey (includes keyboard cable and pointing stick cable)
776475-151	B	Keyboard, backlit, with pointing stick for use in Greece (includes keyboard cable and pointing stick cable)
776475-161	B	Keyboard, backlit, with pointing stick for use in Latin America (includes keyboard cable and pointing stick cable)
776475-171	B	Keyboard, backlit, with pointing stick for use in Saudi Arabia (includes keyboard cable and pointing stick cable)
776475-201	B	Keyboard, backlit, with pointing stick for use in Brazil (includes keyboard cable and pointing stick cable)
776475-211	B	Keyboard, backlit, with pointing stick for use in Hungary (includes keyboard cable and pointing stick cable)
776475-251	B	Keyboard, backlit, with pointing stick for use in Russia (includes keyboard cable and pointing stick cable)
776475-261	B	Keyboard, backlit, with pointing stick for use in Bulgaria (includes keyboard cable and pointing stick cable)
776475-271	B	Keyboard, backlit, with pointing stick for use in Romania (includes keyboard cable and pointing stick cable)
776475-281	B	Keyboard, backlit, with pointing stick for use in Thailand (includes keyboard cable and pointing stick cable)

Spare part number	CSR flag	Description
776475-291	B	Keyboard, backlit, with pointing stick for use in Japan (includes keyboard cable and pointing stick cable)
776475-A41	B	Keyboard, backlit, with pointing stick for use in Belgium (includes keyboard cable and pointing stick cable)
776475-AB1	B	Keyboard, backlit, with pointing stick for use in Taiwan (includes keyboard cable and pointing stick cable)
776475-AD1	B	Keyboard, backlit, with pointing stick for use in South Korea (includes keyboard cable and pointing stick cable)
776475-B31	B	Keyboard, backlit, with pointing stick for use in the Netherlands (includes keyboard cable and pointing stick cable)
776475-B71	B	Keyboard, backlit, with pointing stick for use in Sweden and Finland (includes keyboard cable and pointing stick cable)
776475-BA1	B	Keyboard, backlit, with pointing stick for use in Slovenia (includes keyboard cable and pointing stick cable)
776475-BB1	B	Keyboard, backlit, with pointing stick for use in Israel (includes keyboard cable and pointing stick cable)
776475-BG1	B	Keyboard, backlit, with pointing stick for use in Switzerland (includes keyboard cable and pointing stick cable)
776475-D61	B	Keyboard, backlit, with pointing stick for use in India (includes keyboard cable and pointing stick cable)
776475-DB1	B	Keyboard, backlit, with pointing stick for use in Canada (includes keyboard cable and pointing stick cable)
776475-DD1	B	Keyboard, backlit, with pointing stick for use in Iceland (includes keyboard cable and pointing stick cable)
776475-FL1	B	Keyboard, backlit, with pointing stick for use in the Czech Republic and Slovakia (includes keyboard cable and pointing stick cable)
776475-FP1	B	Keyboard, backlit, with pointing stick for use in Northwest Africa (includes keyboard cable and pointing stick cable)
777326-001	N	Webcam module
777834-001	C	Raw display panel, <b>(39.6 cm)</b> 15.6 in HD AG SVA 45% CG 200 nits (cd/m <sup>2</sup> ) eDP 1.2 flat (1366x768)
777835-001	C	Raw display panel, <b>(39.6 cm)</b> 15.6 in FHD AG SVA 60% CG 300 nits (cd/m <sup>2</sup> ) eDP 1.2 slim (1920x1080)
779682-001	N	Display enclosure for use in HP EliteBook 745 models
779683-001	N	Top cover for use only on HP EliteBook 745 models (includes TouchPad)
779684-001	N	Internal base enclosure for use only on HP EliteBook 745 models (includes RJ-45 door with spring)
779686-001	N	Display enclosure for use in HP EliteBook 755 models
779687-001	N	Top cover for use only on HP EliteBook 755 models (includes TouchPad)
779688-001	C	Internal base enclosure for use only on HP EliteBook 755 models (includes RJ-45 door with spring)
780080-001	N	Antennas (WLAN, WWAN) for use only on HP EliteBook 745 models
780081-001	N	Antennas (WLAN, WWAN) for use only on HP EliteBook 755 models
802541-001	N	System board with AMD A6-7050B G2 processor for use in computer models without the Windows 8.1 operating system (Gold)

<b>Spare part number</b>	<b>CSR flag</b>	<b>Description</b>
802541-0C1	N	System board with AMD A6-7050B G2 processor for use in computer models without the Windows 8.1 operating system (Gold Conversion Kit)
802541-501	N	System board with AMD A6-7050B G2 processor for use with the Windows 8.1 Standard operating system (Gold)
802541-5C1	N	System board with AMD A6-7050B G2 processor for use with the Windows 8.1 Standard operating system (Gold Conversion Kit)
802541-601	N	System board with AMD A6-7050B G2 processor for use with the Windows 8.1 Professional operating system (Gold)
802541-6C1	N	System board with AMD A6-7050B G2 processor for use with the Windows 8.1 Professional operating system (Gold Conversion Kit)
802542-001	N	System board with AMD A8-7150B G2 processor for use with computer models without the Windows 8.1 operating system (Gold)
802542-0C1	N	System board with AMD A8-7150B G2 processor for use with computer models without the Windows 8.1 operating system (Gold Conversion Kit)
802542-501	N	System board with AMD A8-7150B G2 processor for use with the Windows 8.1 Standard operating system (Gold)
802542-5C1	N	System board with AMD A8-7150B G2 processor for use with the Windows 8.1 Standard operating system (Gold Conversion Kit)
802542-601	N	System board with AMD A8-7150B G2 processor for use with the Windows 8.1 Professional operating system (Gold)
802542-6C1	N	System board with AMD A8-7150B G2 processor for use with the Windows 8.1 Professional operating system (Gold Conversion Kit)
802543-001	N	System board with AMD A10-7350B G2 processor for use in computer models without the Windows 8.1 operating system (Gold)
802543-0C1	N	System board with AMD A10-7350B G2 processor for use in computer models without the Windows 8.1 operating system (Gold Conversion Kit)
802543-501	N	System board with AMD A10-7350B G2 processor for use with the Windows 8.1 Standard operating system (Gold)
802543-5C1	N	System board with AMD A10-7350B G2 processor for use with the Windows 8.1 Standard operating system (Gold Conversion Kit)
802543-601	N	System board with AMD A10-7350B G2 processor for use with the Windows 8.1 Professional operating system (Gold)
802543-6C1	N	System board with AMD A10-7350B G2 processor for use with the Windows 8.1 Professional operating system (Gold Conversion Kit)



---

# 4 Removal and replacement procedures preliminary requirements

## Tools required

You will need the following tools to complete the removal and replacement procedures:

- Flat-bladed screwdriver
- Magnetic screwdriver
- Phillips P0 and P1 screwdrivers

## Service considerations

The following sections include some of the considerations that you must keep in mind during disassembly and assembly procedures.

---

 **NOTE:** As you remove each subassembly from the computer, place the subassembly (and all accompanying screws) away from the work area to prevent damage.

---

## Plastic parts

---

 **CAUTION:** Using excessive force during disassembly and reassembly can damage plastic parts. Use care when handling the plastic parts. Apply pressure only at the points designated in the maintenance instructions.

---

## Cables and connectors

---

 **CAUTION:** When servicing the computer, be sure that cables are placed in their proper locations during the reassembly process. Improper cable placement can damage the computer.

---

Cables must be handled with extreme care to avoid damage. Apply only the tension required to unseat or seat the cables during removal and insertion. Handle cables by the connector whenever possible. In all cases, avoid bending, twisting, or tearing cables. Be sure that cables are routed in such a way that they cannot be caught or snagged by parts being removed or replaced. Handle flex cables with extreme care; these cables tear easily.

## Drive handling

---

**⚠ CAUTION:** Drives are fragile components that must be handled with care. To prevent damage to the computer, damage to a drive, or loss of information, observe these precautions:

Before removing or inserting a hard drive, shut down the computer. If you are unsure whether the computer is off or in Hibernation, turn the computer on, and then shut it down through the operating system.

Before handling a drive, be sure that you are discharged of static electricity. While handling a drive, avoid touching the connector.

Before removing a diskette drive or optical drive, be sure that a diskette or disc is not in the drive and be sure that the optical drive tray is closed.

Handle drives on surfaces covered with at least one inch of shock-proof foam.

Avoid dropping drives from any height onto any surface.

After removing a hard drive, an optical drive, or a diskette drive, place it in a static-proof bag.

Avoid exposing an internal hard drive to products that have magnetic fields, such as monitors or speakers.

Avoid exposing a drive to temperature extremes or liquids.

If a drive must be mailed, place the drive in a bubble pack mailer or other suitable form of protective packaging and label the package “FRAGILE.”

---

## Grounding guidelines

### Electrostatic discharge damage

Electronic components are sensitive to electrostatic discharge (ESD). Circuitry design and structure determine the degree of sensitivity. Networks built into many integrated circuits provide some protection, but in many cases, ESD contains enough power to alter device parameters or melt silicon junctions.

A discharge of static electricity from a finger or other conductor can destroy static-sensitive devices or microcircuitry. Even if the spark is neither felt nor heard, damage may have occurred.

An electronic device exposed to ESD may not be affected at all and can work perfectly throughout a normal cycle. Or the device may function normally for a while, then degrade in the internal layers, reducing its life expectancy.

---

**⚠ CAUTION:** To prevent damage to the computer when you are removing or installing internal components, observe these precautions:

Keep components in their electrostatic-safe containers until you are ready to install them.

Before touching an electronic component, discharge static electricity by using the guidelines described in this section.

Avoid touching pins, leads, and circuitry. Handle electronic components as little as possible.

If you remove a component, place it in an electrostatic-safe container.

---

The following table shows how humidity affects the electrostatic voltage levels generated by different activities.

 **CAUTION:** A product can be degraded by as little as 700 V.

<b>Typical electrostatic voltage levels</b>			
<b>Event</b>	<b>Relative humidity</b>		
	<b>10%</b>	<b>40%</b>	<b>55%</b>
Walking across carpet	35,000 V	15,000 V	7,500 V
Walking across vinyl floor	12,000 V	5,000 V	3,000 V
Motions of bench worker	6,000 V	800 V	400 V
Removing DIPS from plastic tube	2,000 V	700 V	400 V
Removing DIPS from vinyl tray	11,500 V	4,000 V	2,000 V
Removing DIPS from Styrofoam	14,500 V	5,000 V	3,500 V
Removing bubble pack from PCB	26,500 V	20,000 V	7,000 V
Packing PCBs in foam-lined box	21,000 V	11,000 V	5,000 V

## Packaging and transporting guidelines

Follow these grounding guidelines when packaging and transporting equipment:

- To avoid hand contact, transport products in static-safe tubes, bags, or boxes.
- Protect ESD-sensitive parts and assemblies with conductive or approved containers or packaging.
- Keep ESD-sensitive parts in their containers until the parts arrive at static-free workstations.
- Place items on a grounded surface before removing items from their containers.
- Always be properly grounded when touching a component or assembly.
- Store reusable ESD-sensitive parts from assemblies in protective packaging or nonconductive foam.
- Use transporters and conveyors made of antistatic belts and roller bushings. Be sure that mechanized equipment used for moving materials is wired to ground and that proper materials are selected to avoid static charging. When grounding is not possible, use an ionizer to dissipate electric charges.

## Workstation guidelines

Follow these grounding workstation guidelines:

- Cover the workstation with approved static-shielding material.
- Use a wrist strap connected to a properly grounded work surface and use properly grounded tools and equipment.
- Use conductive field service tools, such as cutters, screwdrivers, and vacuums.
- When fixtures must directly contact dissipative surfaces, use fixtures made only of static-safe materials.
- Keep the work area free of nonconductive materials, such as ordinary plastic assembly aids and Styrofoam.
- Handle ESD-sensitive components, parts, and assemblies by the case or PCM laminate. Handle these items only at static-free workstations.
- Avoid contact with pins, leads, or circuitry.
- Turn off power and input signals before inserting or removing connectors or test equipment.



## Equipment guidelines

Grounding equipment must include either a wrist strap or a foot strap at a grounded workstation.

- When seated, wear a wrist strap connected to a grounded system. Wrist straps are flexible straps with a minimum of one megohm  $\pm 10\%$  resistance in the ground cords. To provide proper ground, wear a strap snugly against the skin at all times. On grounded mats with banana-plug connectors, use alligator clips to connect a wrist strap.
- When standing, use foot straps and a grounded floor mat. Foot straps (heel, toe, or boot straps) can be used at standing workstations and are compatible with most types of shoes or boots. On conductive floors or dissipative floor mats, use foot straps on both feet with a minimum of one megohm resistance between the operator and ground. To be effective, the conductive must be worn in contact with the skin.

The following grounding equipment is recommended to prevent electrostatic damage:

- Antistatic tape
- Antistatic smocks, aprons, and sleeve protectors
- Conductive bins and other assembly or soldering aids
- Nonconductive foam
- Conductive tabletop workstations with ground cords of one megohm resistance
- Static-dissipative tables or floor mats with hard ties to the ground
- Field service kits
- Static awareness labels
- Material-handling packages
- Nonconductive plastic bags, tubes, or boxes
- Metal tote boxes
- Electrostatic voltage levels and protective materials

The following table lists the shielding protection provided by antistatic bags and floor mats.

Material	Use	Voltage protection level
Antistatic plastics	Bags	1,500 V
Carbon-loaded plastic	Floor mats	7,500 V
Metallized laminate	Floor mats	5,000 V





# 5 Removal and replacement procedures for Customer Self-Repair parts

 **CAUTION:** The Customer Self-Repair program is not available in all locations. Installing a part not supported by the Customer Self-Repair program may void your warranty. Check your warranty to determine if Customer Self-Repair is supported in your location.

 **NOTE:** HP continually improves and changes product parts. For complete and current information on supported parts for your computer, go to <http://partsurfer.hp.com>, select your country or region, and then follow the on-screen instructions.

## Component replacement procedures

 **NOTE:** Please read and follow the procedures described here to access and replace Customer Self-Repair parts successfully.

 **NOTE:** Details about your computer, including model, serial number, product key, and length of warranty, are on the service label at the bottom of your computer. See [Service Label on page 20](#) for details.

This chapter provides removal and replacement procedures for Customer Self-Repair parts.

There are as many as 15 screws that must be removed, replaced, and/or loosened when servicing the Customer Self-Repair parts. Make special note of each screw size and location during removal and replacement.

## Service door

Description	Spare part number
Service door for use only on HP EliteBook 745 models	768793-001
Service door for use only on HP EliteBook 755 models	773962-001

Before removing the service door, follow these steps:

1. Turn off the computer. If you are unsure whether the computer is off or in Hibernation, turn the computer on, and then shut it down through the operating system.
2. Disconnect the power from the computer by unplugging the power cord from the computer.
3. Disconnect all external devices from the computer.

Remove the service door:

1. Slide the service door release latch **(1)**, remove the screw (if the optional screw is being used) **(2)**, and then slide the release latch again **(3)** to release the service door.

 **NOTE:** If you do not want to use the optional screw, you can store it inside the service door.

2. Slide the service door toward the front of the computer **(4)** and lift **(5)** to remove the service door.

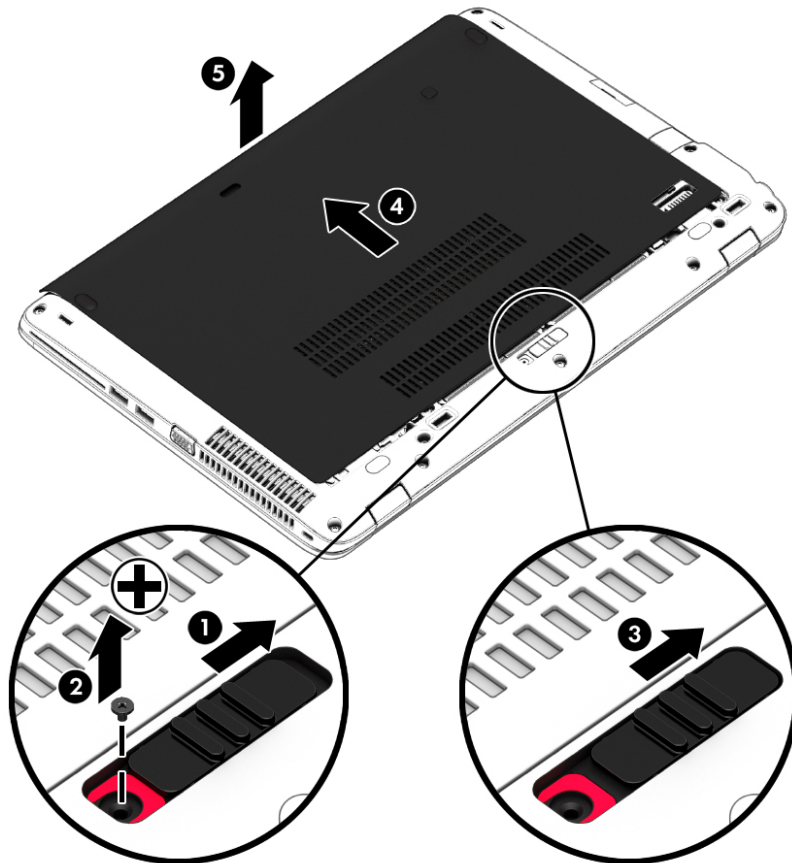

Reverse the removal procedures to install the service door.

## Battery

Description	Spare part number
3-cell, 50-Wh, 4.5-Ah	717376-001
3-cell, 24-Wh, 2.4-Ah	717375-001

Before disassembling the computer, follow these steps:

1. Turn off the computer. If you are unsure whether the computer is off or in Hibernation, turn the computer on, and then shut it down through the operating system.
2. Disconnect the power from the computer by unplugging the power cord from the computer.
3. Disconnect all external devices from the computer.
4. Remove the service door (see [Service door on page 47](#)).

Remove the battery:

1. Slide the battery release latches **(1)**, and then lift the battery **(2)**.
2. Remove the battery from the computer **(3)**.

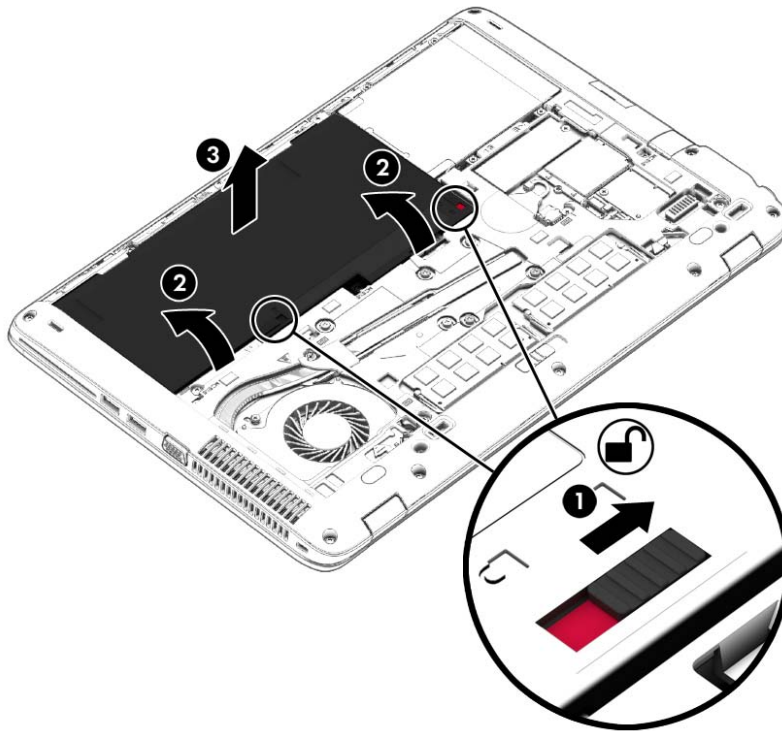

Install the battery by inserting it into the battery bay until you hear a click.

## Hard drive

Description	Spare part number
<b>2.5 in HDD, SATA, 9.5 mm</b> (does not include the hard drive bracket or screws)	
1 TB, 7200 rpm, 9.5 mm	766644-001
<b>2.5 in HDD, SATA, 7 mm</b> (does not include the hard drive bracket or screws)	
500 GB, 7200 rpm, 7 mm, SED	703268-001
500 GB, 7200 rpm, 7 mm	703267-001
500 GB, 5400 rpm, 7 mm, FIPS	730946-001
320 GB, 7200 rpm, 7 mm	634862-001
Hard Drive Hardware Kit (includes hard drive bracket and screws)	730793-001
<b>2.5 in SSD</b> (includes the hard drive bracket and screws)	
256 GB, SATA III, Self-Encrypting Drive (SED), supporting Opal 2.0	768807-001
240 GB, SATA III	768805-001
180 GB, SATA III, SED, supporting Opal 1.0	768804-001
180 GB, SATA III	768803-001
128 GB, SATA III	768802-001

Before removing the hard drive, follow these steps:

1. Turn off the computer. If you are unsure whether the computer is off or in Hibernation, turn the computer on, and then shut it down through the operating system.
2. Disconnect the power from the computer by unplugging the power cord from the computer.
3. Disconnect all external devices from the computer.
4. Remove the service door (see [Service door on page 47](#)).
5. Remove the battery (see [Battery on page 49](#)).

Remove the hard drive:

1. Turn the computer upside down on a flat surface.

2. Loosen the 4 hard drive screws (1). Slide the hard drive (2) forward, and then remove it (3).

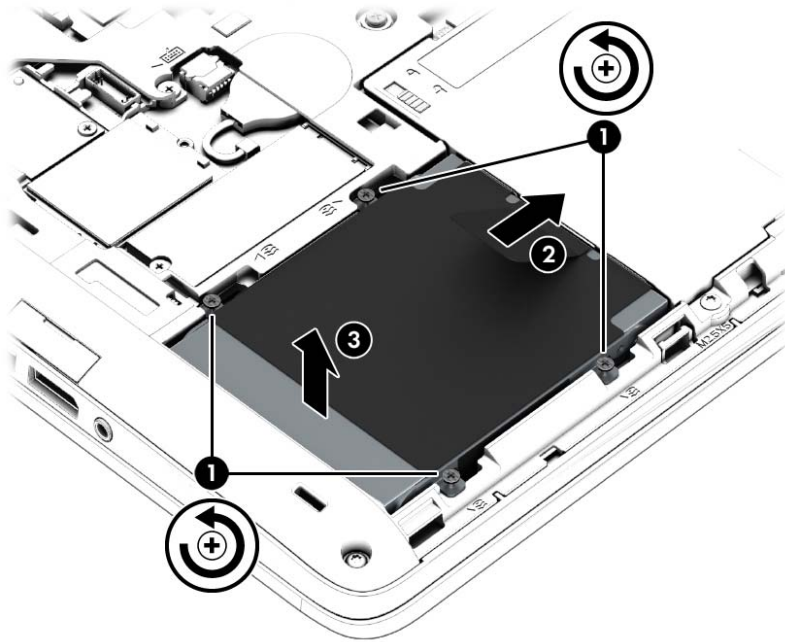

3. If it is necessary to disassemble the hard drive, perform the following steps:
  - a. Remove the four Phillips PM3.0×3.0 screws (1) that secure the hard drive bracket to the hard drive.
  - b. Slide the hard drive bracket (2) off the hard drive.

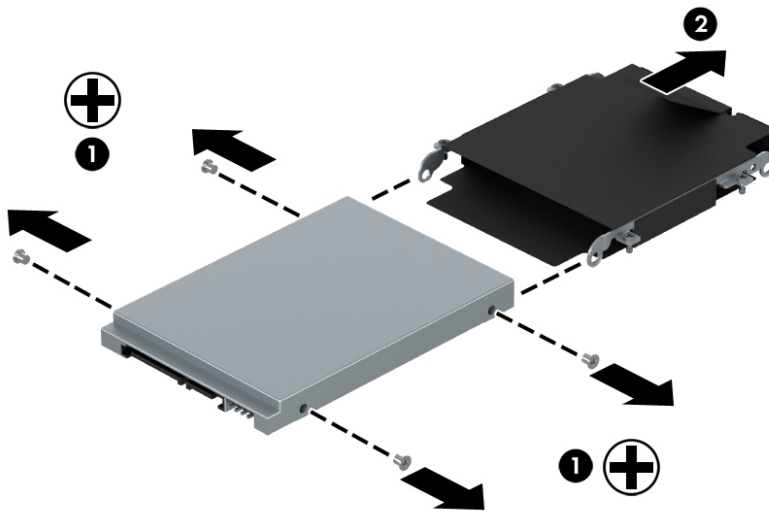

Reverse this procedure to reassemble and install the hard drive.

## Memory module

Description	Spare part number
8 GB memory module (PC3L, 12800, 1600 MHz)	693374-001
4 GB memory module (PC3L, 12800, 1600 MHz)	691740-001

### Update BIOS before adding memory modules

Before adding new memory, make sure you update the computer to the latest BIOS. For Windows 8.1 models, see [Updating the BIOS on page 100](#), and for Windows 7 models, see [Updating the BIOS on page 108](#). For Ubuntu models, go to <http://www.hp.com/support>, and select your country. Select **Drivers & Downloads**, and then follow the on-screen instructions.

 **CAUTION:** Failure to update the computer to the latest BIOS prior to installing new memory may result in various system problems.

Before removing a memory module, follow these steps:

1. Turn off the computer. If you are unsure whether the computer is off or in Hibernation, turn the computer on, and then shut it down through the operating system.
2. Disconnect the power from the computer by unplugging the power cord from the computer.
3. Disconnect all external devices from the computer.
4. Remove the service door (see [Service door on page 47](#)).
5. Remove the battery (see [Battery on page 49](#)).

Remove the memory module:

1. Spread the retaining tabs **(1)** on each side of the memory module slot to release the memory module. (The edge of the module opposite the slot rises away from the computer.)



2. Remove the memory module **(2)** by pulling the module away from the slot at an angle.

 **NOTE:** Memory modules are designed with a notch to prevent incorrect insertion into the memory module slot.

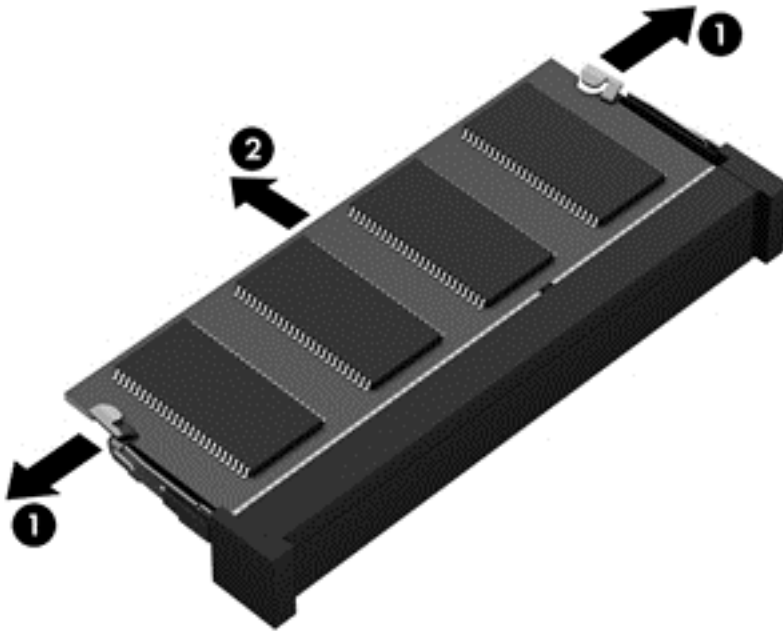

Reverse this procedure to install a memory module.

## WWAN module



**NOTE:** The WWAN module and the WLAN module are not interchangeable.

Description	Spare part number
HP lt4211 LTE/EV-DO/HSPA+4G Mobile Broadband Module	748021-001
HP lt4112 LTE/HSPA+ 4G Broadband Module	740011-001
HP hs3110 HSPA+ Mobile Broadband Module	748599-001

Before removing the WWAN module, follow these steps:

1. Turn off the computer. If you are unsure whether the computer is off or in Hibernation, turn the computer on, and then shut it down through the operating system.
2. Disconnect the power from the computer by unplugging the power cord from the computer.
3. Disconnect all external devices from the computer.
4. Remove the service door (see [Service door on page 47](#)).
5. Remove the battery (see [Battery on page 49](#)).

Remove the WWAN module:

1. Disconnect the WWAN antenna cables **(1)** from the terminals on the WWAN module.





**NOTE:** The red WWAN antenna cable is connected to the WWAN module “Main” terminal. The blue WWAN antenna cable is connected to the WWAN module “Aux” terminal.

2. Remove the Phillips PM2.0×3.0 screw **(2)** that secures the WWAN module to the base enclosure.

3. Remove the WWAN module (3) by pulling the module away from the slot.

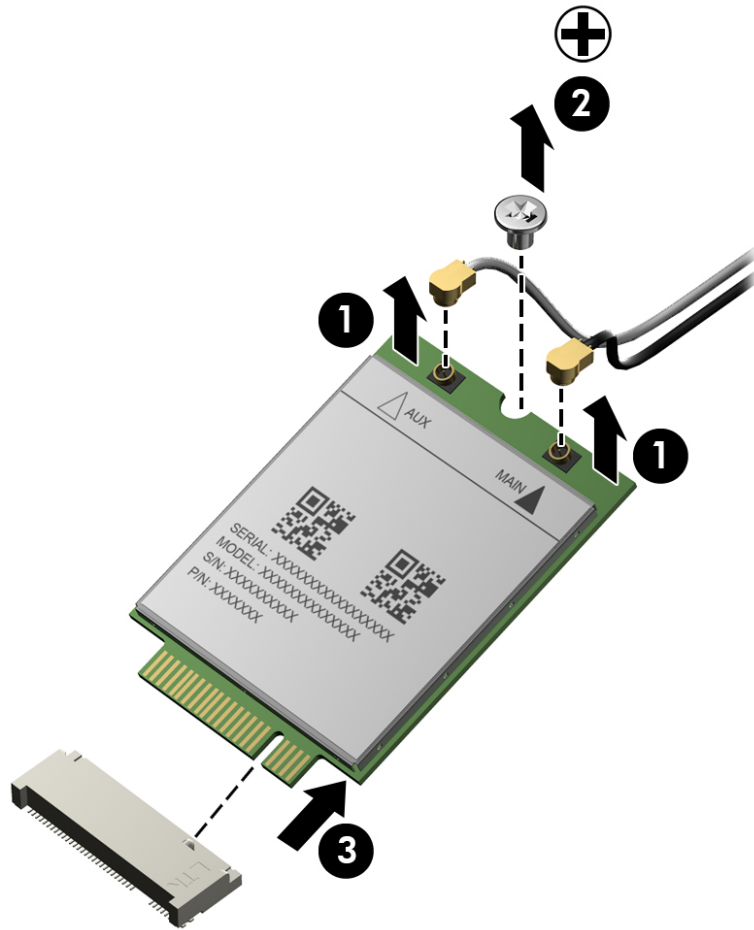
 **NOTE:** WWAN modules are designed with a notch to prevent incorrect insertion.



 **NOTE:** If the WWAN antennas are not connected to the terminals on the WWAN module, the protective sleeves must be installed on the antenna connectors, as shown in the following illustration.

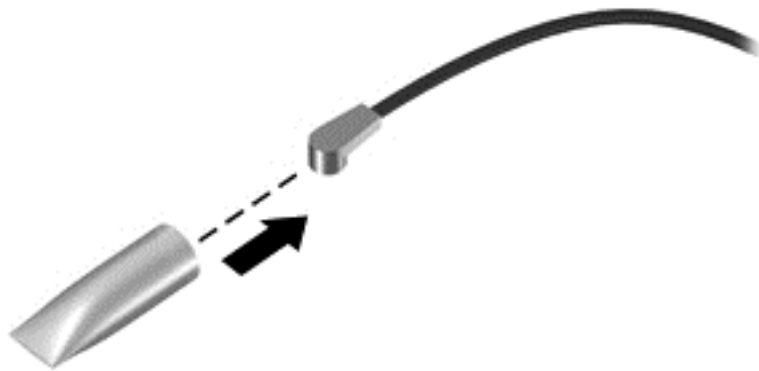

Reverse this procedure to install the WWAN module.

## WLAN module

Description	Spare part number
Qualcomm Atheros AR9485 802.11 b/g/n 1x1 WiFi Adaptor (select models only)	675794-001
Broadcom BCM4352 802.11ac 2x2 Wi-Fi + Bluetooth 4.0 combo (select models only)	724935-001
Broadcom BCM943228HMB WiDi 802.11 a/b/g/n 2x2 Wi-Fi + Bluetooth 4.0 combo (select models only)	730668-001

 **CAUTION:** To prevent an unresponsive system, replace the wireless module only with a wireless module authorized for use in the computer by the governmental agency that regulates wireless devices in your country or region. If you replace the module and then receive a warning message, remove the module to restore device functionality, and then contact technical support.

Before removing the WLAN module, follow these steps:

1. Turn off the computer. If you are unsure whether the computer is off or in Hibernation, turn the computer on, and then shut it down through the operating system.
2. Disconnect the power from the computer by unplugging the power cord from the computer.
3. Disconnect all external devices from the computer.
4. Remove the service door (see [Service door on page 47](#)).
5. Remove the battery (see [Battery on page 49](#)).

Remove the WLAN module:

1. Disconnect the WLAN antenna cables **(1)** from the terminals on the WLAN module.





**NOTE:** The WLAN antenna cable labeled “1” connects to the WLAN module “Main” terminal labeled “1”. The WLAN antenna cable labeled “2” connects to the WLAN module “Aux” terminal labeled “2”. If the computer is equipped with an 802.11a/b/g/n WLAN module, the yellow WLAN antenna cable connects to the middle terminal on the WLAN module.

2. Remove the two Phillips PM2.0×3.0 screws **(2)** that secure the WLAN module to the base enclosure. (The WLAN module tilts up.)

3. Remove the WLAN module (3) by pulling the module away from the slot at an angle.

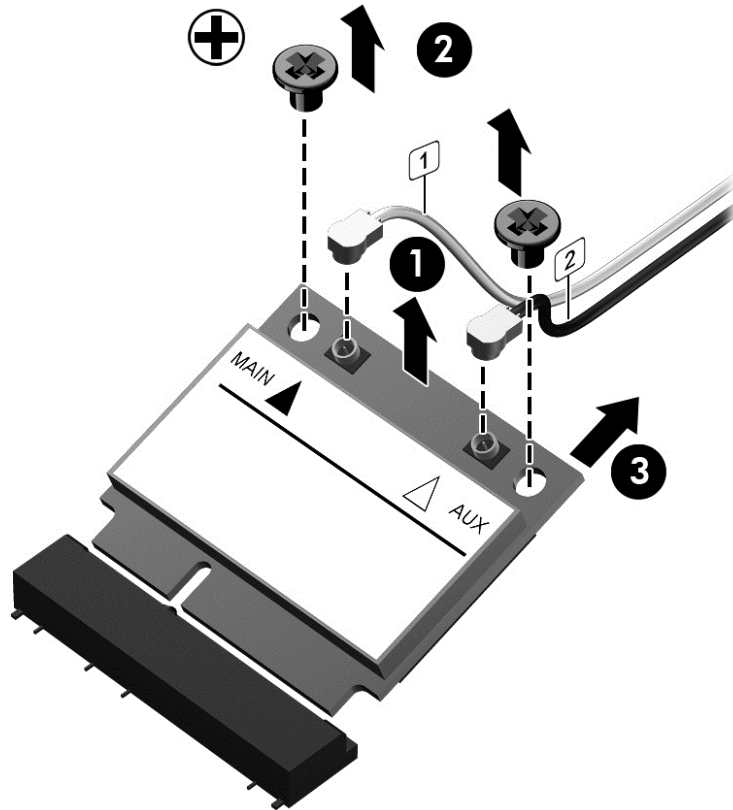
 **NOTE:** WLAN modules are designed with a notch to prevent incorrect insertion.



 **NOTE:** If the WLAN antennas are not connected to the terminals on the WLAN module, the protective sleeves must be installed on the antenna connectors, as shown in the following illustration.

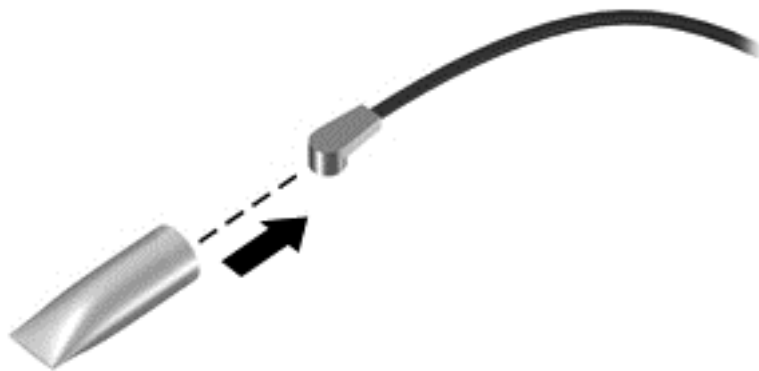

Reverse this procedure to install the WLAN module.

## Keyboard

 **NOTE:** For a detailed list of available keyboards, see [Sequential part number listing on page 33](#).

Description	Spare part number
Keyboard with pointing stick, no backlight	776474-xx1
Keyboard with pointing stick and backlight	776475-xx1

Before removing the keyboard, follow these steps:

1. Turn off the computer. If you are unsure whether the computer is off or in Hibernation, turn the computer on, and then shut it down through the operating system.
2. Disconnect the power from the computer by unplugging the power cord from the computer.
3. Disconnect all external devices from the computer.
4. Remove the service door (see [Service door on page 47](#)).
5. Remove the battery (see [Battery on page 49](#)).

Remove the keyboard:

1. Loosen the two Phillips captive screws that secure the keyboard to the computer.

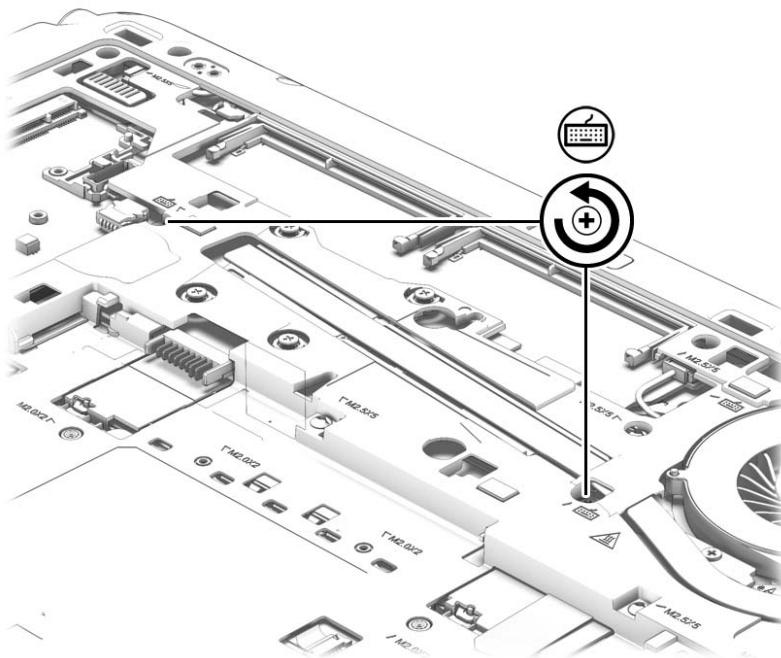

2. Rest and secure the partially open computer on its side.

3. Insert a screw driver or similar thin tool into the keyboard release hole, and then press on the back of the keyboard until the keyboard disengages from the computer.

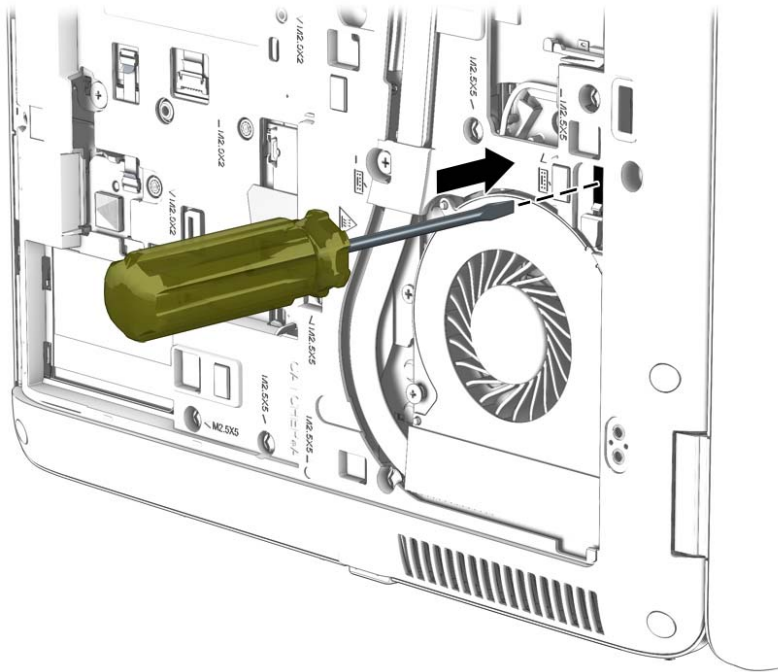

4. Position the computer right-side up with the front toward you.
5. Lift the rear edge of the keyboard upward.



---

 **NOTE:** Continue to step 7 for a keyboard with a backlight.

---

6. To remove the keyboard from models without a backlight:
  - a. Swing the keyboard up and forward **(1)** until it rests upside down on the palm rest.
  - b. Disconnect the main keyboard cable from the zero insertion force (ZIF) connector **(2)** on the system board.

- c. Disconnect the pointing stick cable from the zero insertion force (ZIF) connector **(3)** on the system board.
- d. Remove the keyboard **(4)**.

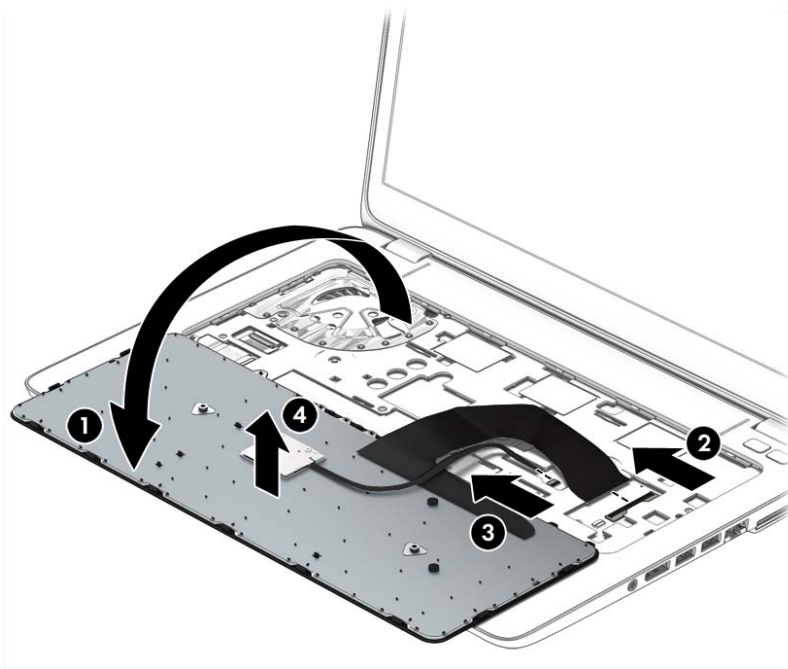

- 7. To remove the keyboard from models with a backlight:
  - a. Swing the keyboard up and forward **(1)** until it rests upside down on the palm rest.
  - b. Disconnect the main keyboard cable from the zero insertion force (ZIF) connector **(2)** on the system board.
  - c. Disconnect the pointing stick cable from the zero insertion force (ZIF) connector **(3)** on the system board.
  - d. Disconnect the backlight cable from the zero insertion force (ZIF) connector **(4)** on the system board.



e. Remove the keyboard (5).

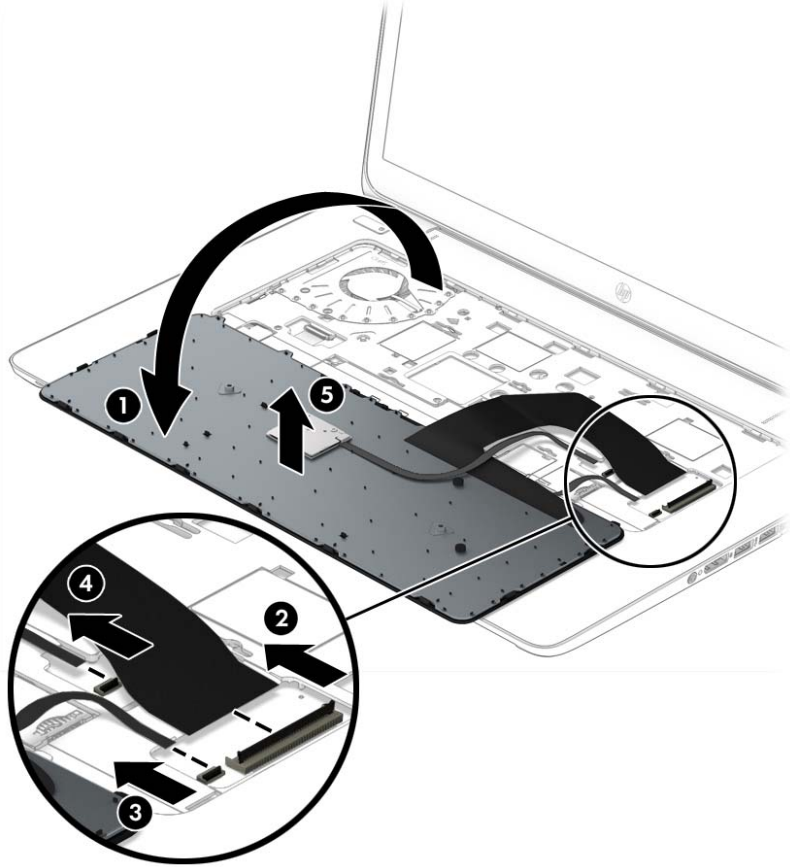

Reverse this procedure to install the keyboard.



# 6 Removal and replacement procedures for Authorized Service Provider parts

 **CAUTION:** Components described in this chapter should only be accessed by an authorized service provider. Accessing these parts can damage the computer or void the warranty.

 **NOTE:** HP continually improves and changes product parts. For complete and current information on supported parts for your computer, go to <http://partsurfer.hp.com>, select your country or region, and then follow the on-screen instructions.

## Component replacement procedures

 **NOTE:** Details about your computer, including model, serial number, product key, and length of warranty, are on the service label at the bottom of your computer. See [Service Label on page 20](#) for details.

This chapter provides removal and replacement procedures for Authorized Service Provider only parts.

There are as many as 61 screws that must be removed, replaced, and/or loosened when servicing the Authorized Service Provider parts. Make special note of each screw size and location during removal and replacement.

## Display panel (non-touch)

 **NOTE:** Non-touch displays are spared at the subcomponent level only. Touch displays are only spared as a whole (touch display components are not spared).

In non-touch models, you can remove the raw display panel with the display assembly still connected to the computer. The following section shows how to remove the raw display panel without removing the display assembly from the computer.

See [Display assembly on page 92](#) later in this chapter to remove internal components that require that you remove the display assembly.

Description	Spare part number
<b>Display bezel</b>	
Display bezel for use in HP EliteBook 745 models	768808-001
Display bezel for use in HP EliteBook 755 models	773963-001
<b>Display panel</b>	
<b>(35.6 cm)</b> 14.0 in LED, HD, AntiGlare (AG), SVA (1366×768), 200 nits (cd/m <sup>2</sup> ), flat	768809-001

Description	Spare part number
<b>(35.6 cm)</b> 14.0 in LED, HD+, AG, SVA (1920×1080), 250 nits (cd/m <sup>2</sup> ), flat	768810-001
<b>(35.6 cm)</b> 14.0 in LED, FHD, AG, SVA (1920×1080), 300 nits (cd/m <sup>2</sup> ), slim	768811-001
<b>(39.6 cm)</b> 15.6 in FHD AG SVA 60% CG 300 nits (cd/m <sup>2</sup> ) eDP 1.2 slim (1920×1080)	777835-001
<b>(39.6 cm)</b> 15.6 in HD AG SVA 45% CG 200 nits (cd/m <sup>2</sup> ) eDP 1.2 flat (1366×768)	777834-001
<b>Webcam module</b>	777326-001
<b>Microphone module</b>	730795-001

Before removing the display assembly, follow these steps:

1. Turn off the computer. If you are unsure whether the computer is off or in Hibernation, turn the computer on, and then shut it down through the operating system.
2. Disconnect the power from the computer by unplugging the power cord from the computer.
3. Disconnect all external devices from the computer.
4. Remove the service door (see [Service door on page 47](#)).
5. Remove the battery (see [Battery on page 49](#)).

Remove the display panel:

1. Lift to disengage the bezel on the bottom **(1)**, left and right sides **(2)**, and top **(3)**.
2. Remove the bezel from the display assembly **(4)**.

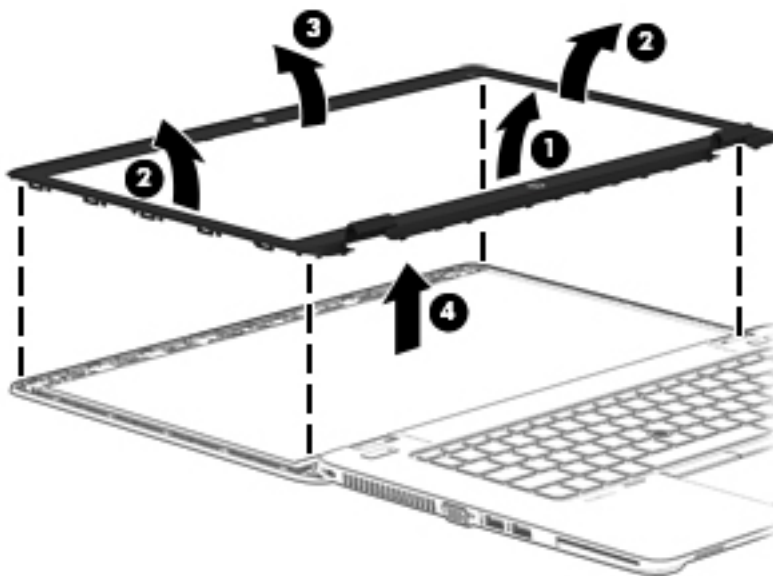

3. Remove the four Phillips PM2.0×3.0 screws **(1)** that secure the display panel to the display enclosure.

4. Lift and rotate the panel onto the computer (2).

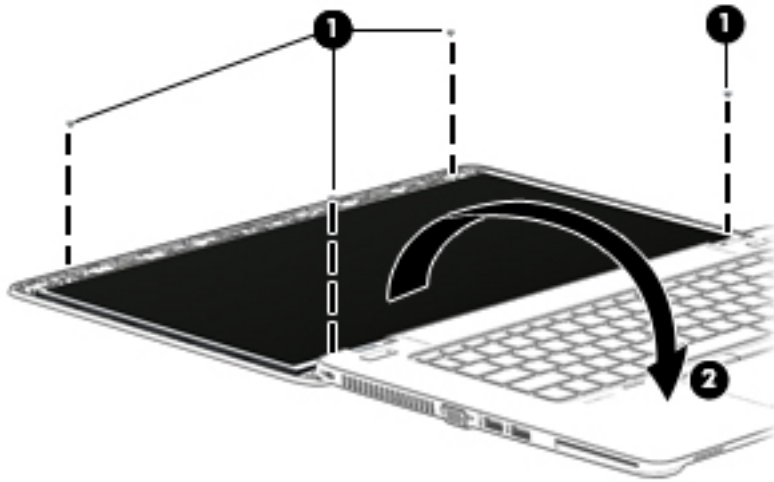

5. On the back of the display panel, lift the tape that secures the display cable to the display panel (1), and the disconnect the display cable from the panel (2).

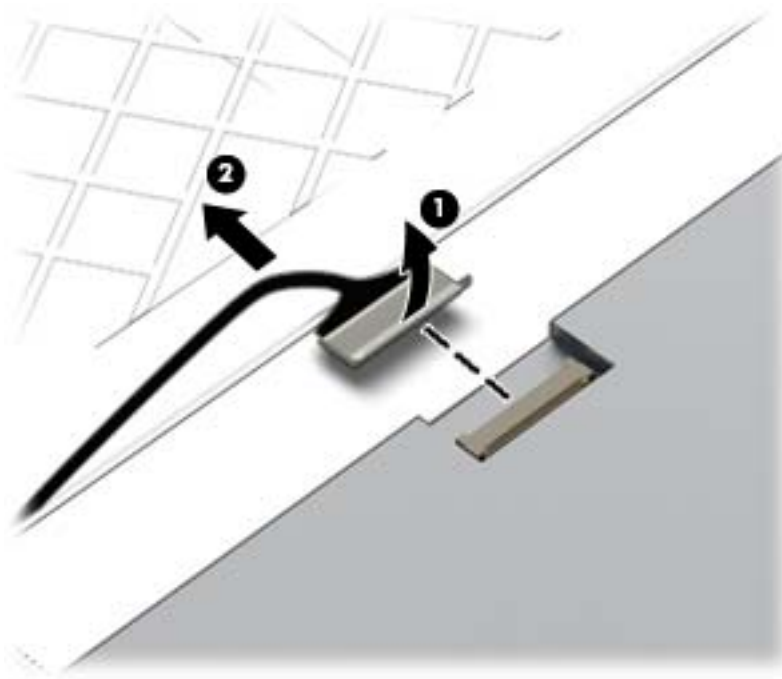

6. Lift the display panel from the display enclosure.

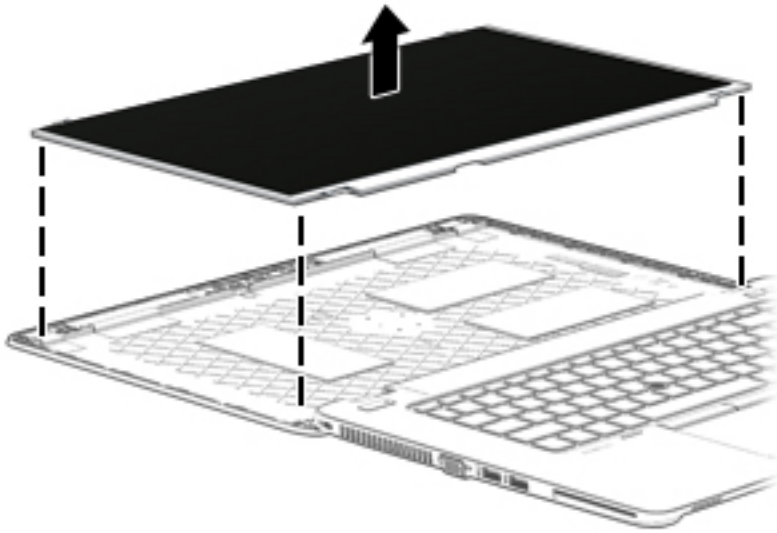

7. If it is necessary to replace the webcam/microphone module:
  - a. Release the tape that secures the webcam cable to the module (1).
  - b. Disconnect the cable (2) from the module.

---

**CAUTION:** Handle the module with caution. The module has a thin profile and is susceptible to damage when not handled carefully.

---

- c. Remove the module (3) from the display enclosure. (The module is attached to the display enclosure with double-sided tape.)

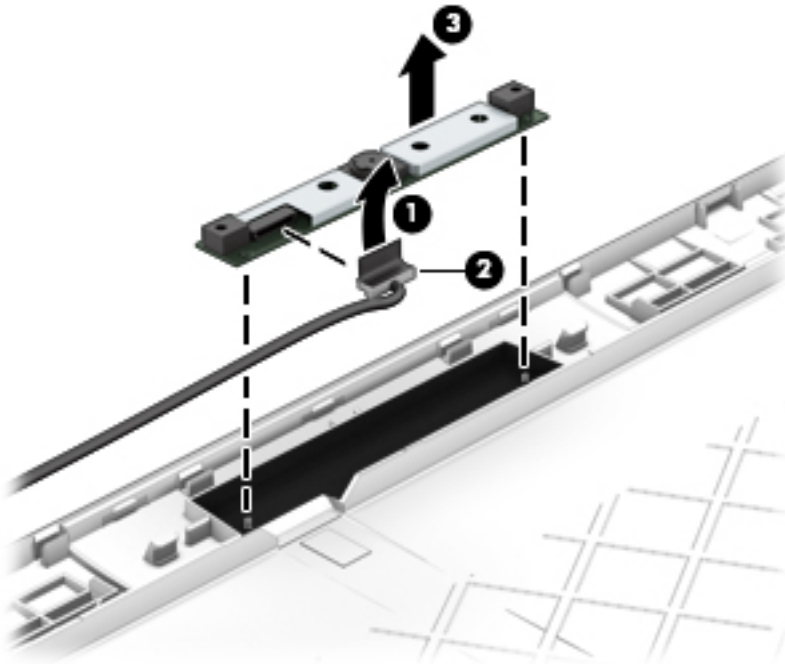

Reverse this procedure to reassemble and install the display panel components.

## RTC battery

Description	Spare part number
RTC battery (includes cable and double-sided tape)	665733-001

Before removing the RTC battery, follow these steps:

1. Turn off the computer. If you are unsure whether the computer is off or in Hibernation, turn the computer on, and then shut it down through the operating system.
2. Disconnect the power from the computer by unplugging the power cord from the computer.
3. Disconnect all external devices from the computer.
4. Remove the service door (see [Service door on page 47](#)).
5. Remove the battery (see [Battery on page 49](#)).

Remove the RTC battery:

1. Disconnect the RTC battery cable **(1)** from the system board.
2. Slide the battery out from the bottom cover **(2)**, and then remove the battery **(3)**. (The RTC battery is attached to the base enclosure with double-sided tape.)

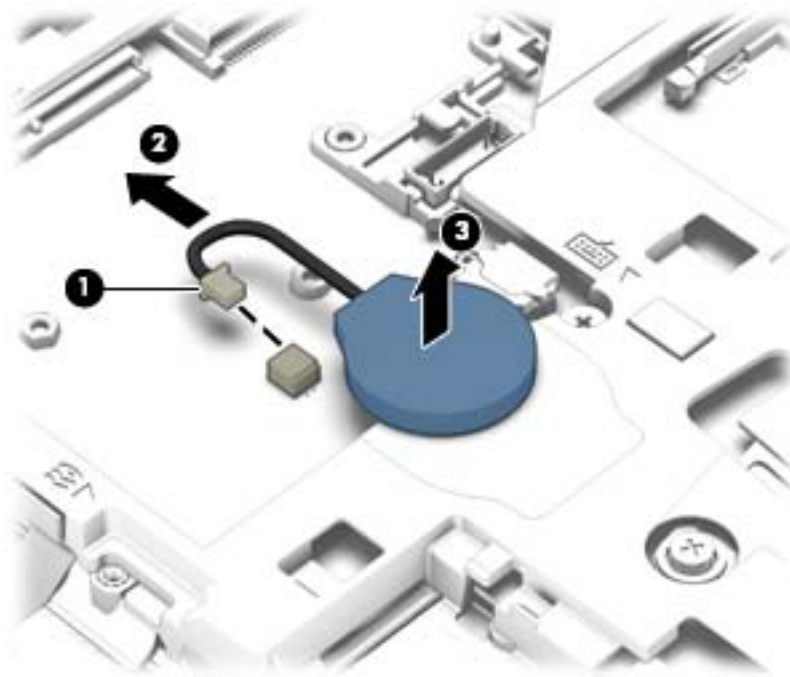

3. Remove the RTC battery.

Reverse this procedure to install the RTC battery.

## Internal base enclosure

Internal base enclosure removal procedures for HP EliteBook 745 models and HP EliteBook 755 models are in separated in the following sections.

### Internal base enclosure (HP EliteBook 745 models)

Description	Spare part number
Internal base enclosure for use only on HP EliteBook 745 models	779684-001

Before removing the internal base enclosure, follow these steps:

1. Turn off the computer. If you are unsure whether the computer is off or in Hibernation, turn the computer on, and then shut it down through the operating system.
2. Disconnect the power from the computer by unplugging the power cord from the computer.
3. Disconnect all external devices from the computer.
4. Remove the following components:
  - a. Service door (see [Service door on page 47](#))
  - b. Battery (see [Battery on page 49](#))
  - c. Keyboard (see [Keyboard on page 58](#))

Use the following image as an overview of all internal base enclosure screw locations.

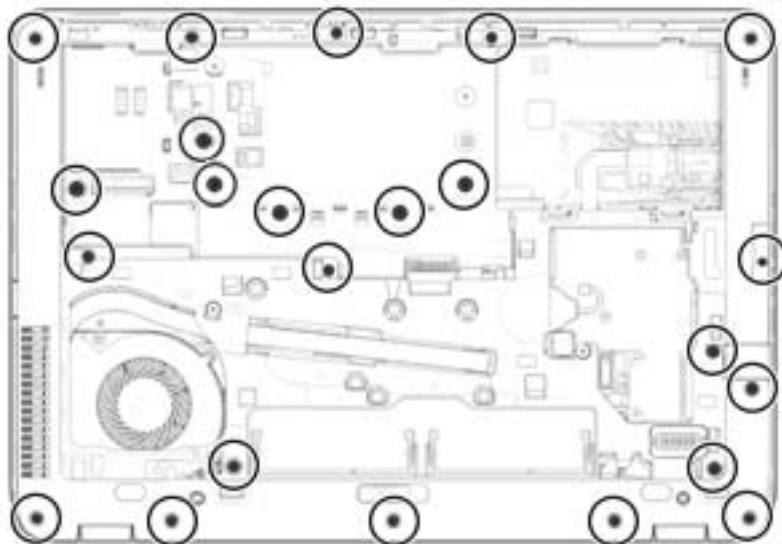

Remove the internal base enclosure:

1. Position the computer upside down.



2. Remove the seven rubber screw covers from the screws outside of the service door.

 **NOTE:** The eight screws outside of the service door also have rubber covers.

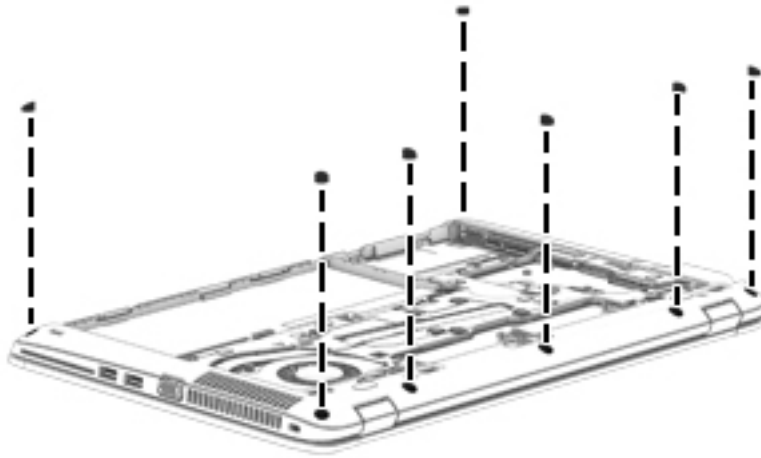

3. Remove the 16 Torx T8M2.5×5.0 screws that secure the internal base enclosure to the computer.

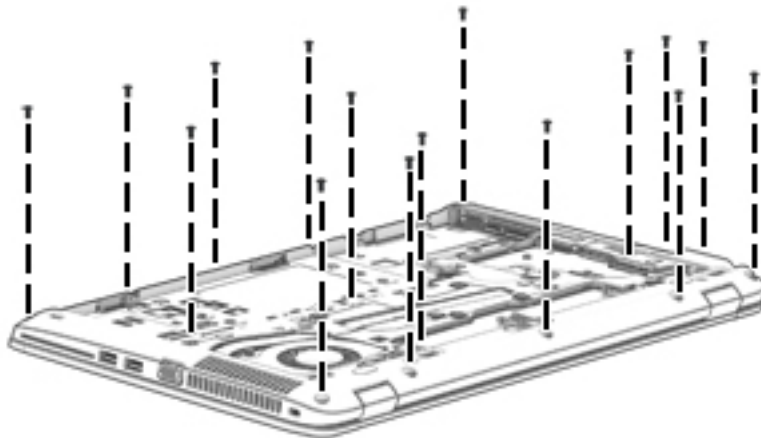

4. Remove the Phillips PM2.0×8.0 screw **(1)** near the media card reader and the six Phillips PM2.0×5.0 broadhead screws **(2)** inside the battery bay that secure the internal base enclosure to the computer.

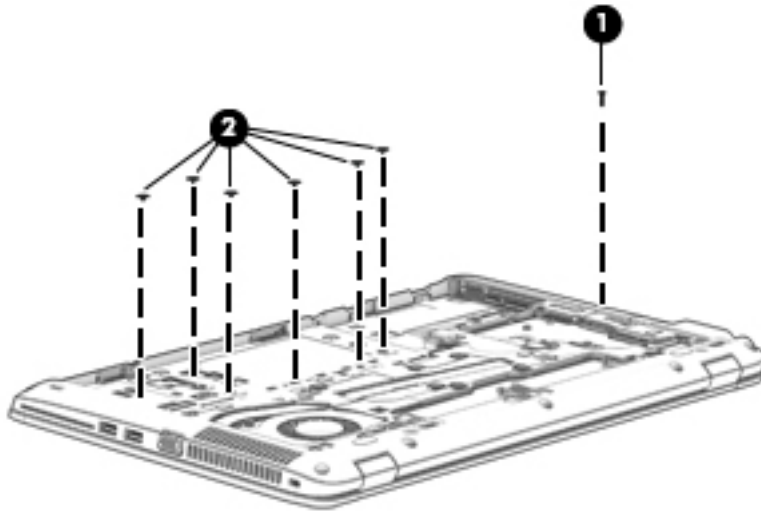

5. Lift the internal base enclosure off the computer.

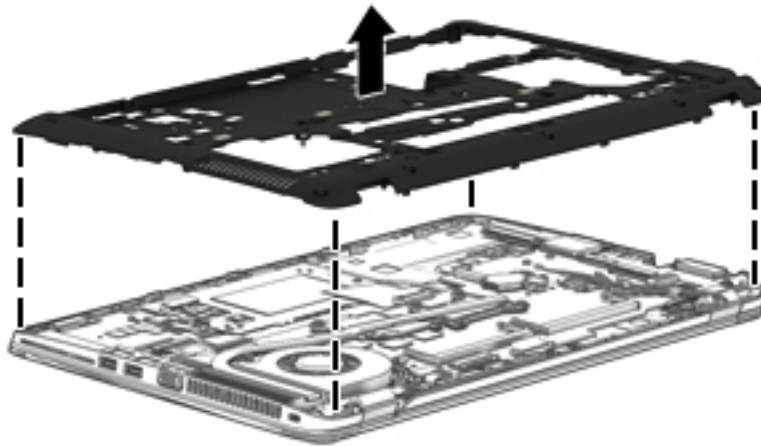

Reverse this procedure to install the base enclosure.

## Internal base enclosure (HP EliteBook 755 models)

Description	Spare part number
Internal base enclosure for use only on HP EliteBook 755 models (includes RJ-45 door with spring)	779688-001

Before removing the internal base enclosure, follow these steps:

1. Turn off the computer. If you are unsure whether the computer is off or in Hibernation, turn the computer on, and then shut it down through the operating system.
2. Disconnect the power from the computer by unplugging the power cord from the computer.
3. Disconnect all external devices from the computer.
4. Remove the following components:
  - a. Service door (see [Service door on page 47](#))
  - b. Battery (see [Battery on page 49](#))
  - c. Keyboard (see [Keyboard on page 58](#))

Use the following image as an overview of all base enclosure screw locations.

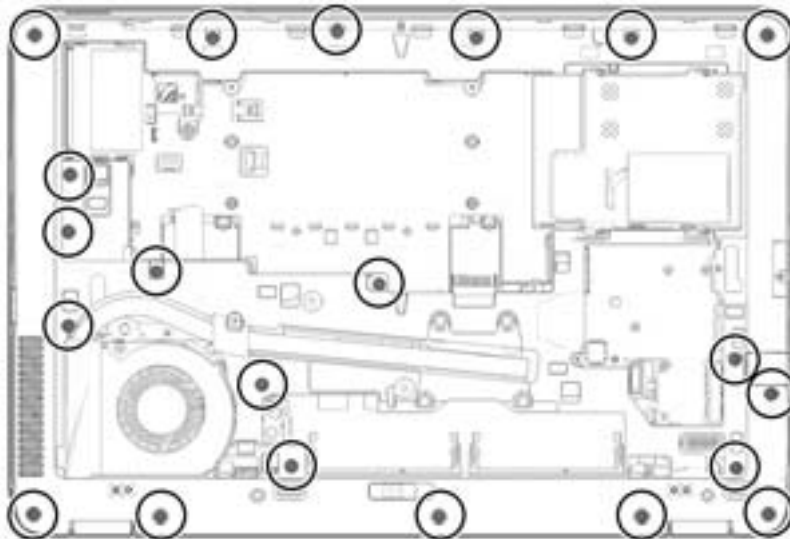

Remove the internal base enclosure:

1. Position the computer upside down.

2. Remove the seven rubber screw covers from the screws outside of the service door.

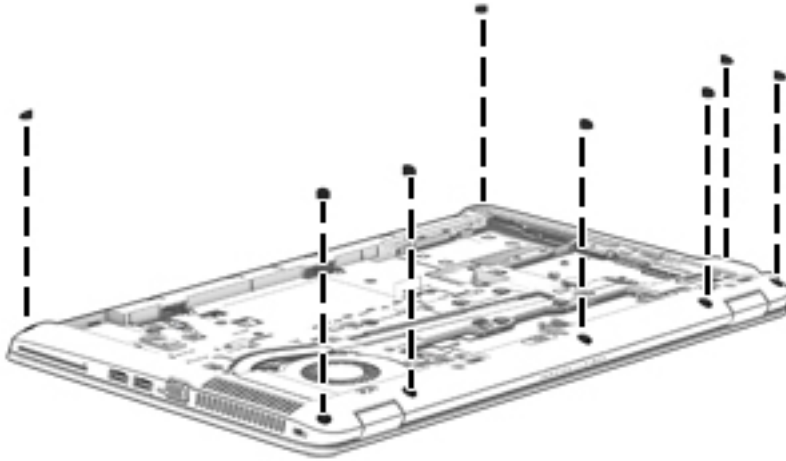

3. Remove the 21 Torx T8M2.5×5.0 screws that secure the internal base enclosure to the computer.

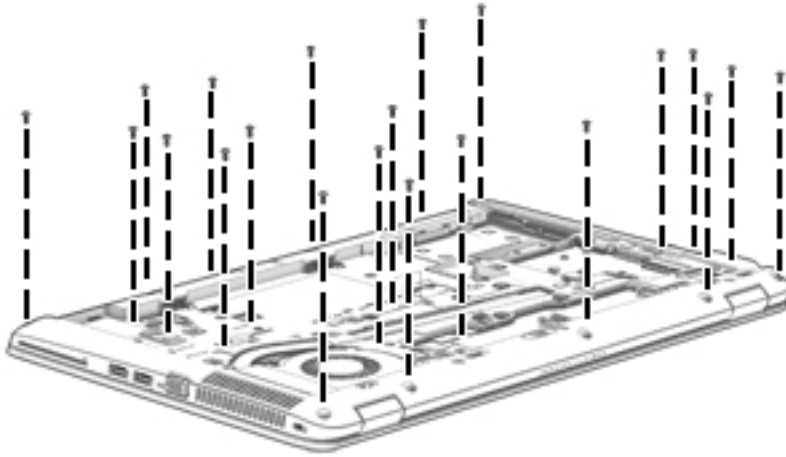

4. Remove the Phillips PM2.0×8.0 screw (1) near the media card reader and the seven Phillips PM2.0×5.0 broadhead screws (2) inside the battery bay that secure the internal base enclosure to the computer.

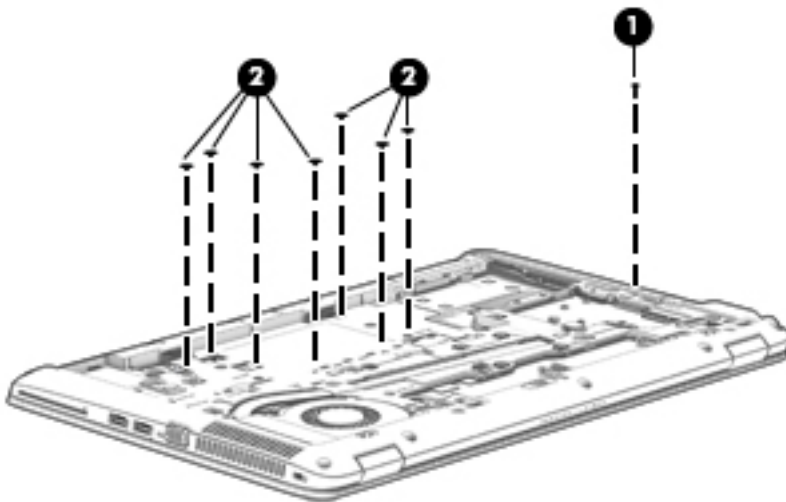

5. Lift the internal base enclosure off the computer.

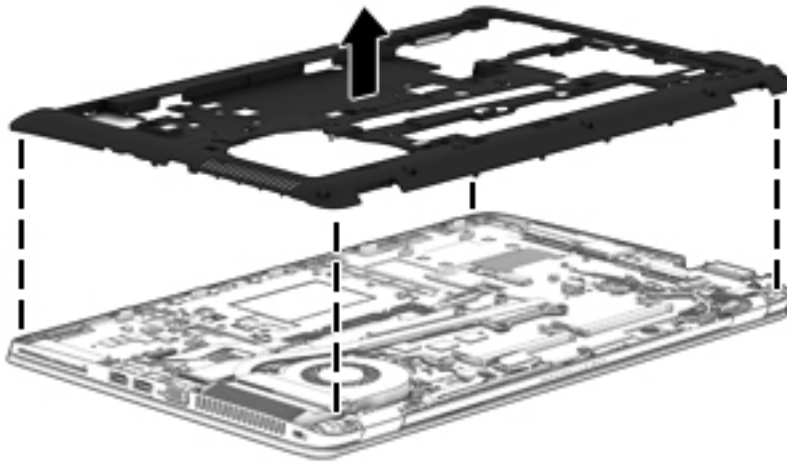

Reverse this procedure to install the internal base enclosure.

## Fan

Description	Spare part number
Fan (includes cable)	730792-001

Before removing the fan, follow these steps:

1. Turn off the computer. If you are unsure whether the computer is off or in Hibernation, turn the computer on, and then shut it down through the operating system.
2. Disconnect the power from the computer by unplugging the power cord from the computer.
3. Disconnect all external devices from the computer.
4. Remove the service door (see [Service door on page 47](#)).
5. Remove the battery (see [Battery on page 49](#)).
6. Remove the keyboard (see [Keyboard on page 58](#)).
7. Remove the internal base enclosure (see [Internal base enclosure on page 68](#)).

Remove the fan:

1. Loosen the two captive Phillips screws (**1**) that secure the fan to the base enclosure.
2. Disconnect the fan cable (**2**) from the system board.
3. Remove the fan (**3**).

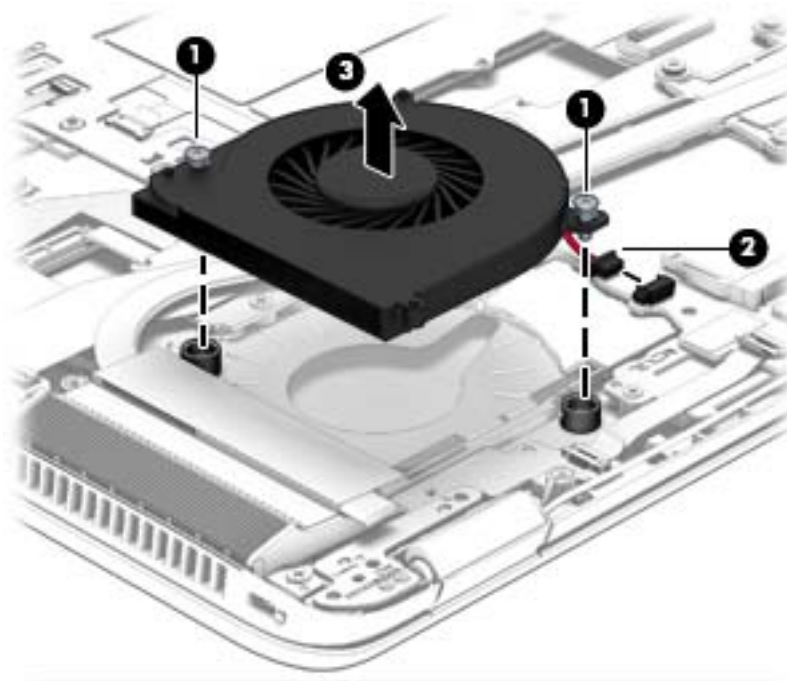

Reverse this procedure to install the fan.

## Card reader board

Description	Spare part number
Card reader board for use in HP EliteBook 745 models	768791-001
Card reader board for use in HP EliteBook 755 models	773960-001

Before removing the card reader board, follow these steps:

1. Turn off the computer. If you are unsure whether the computer is off or in Hibernation, turn the computer on, and then shut it down through the operating system.
2. Disconnect the power from the computer by unplugging the power cord from the computer.
3. Disconnect all external devices from the computer.
4. Remove the following components:
  - a. Service door (see [Service door on page 47](#))
  - b. Battery (see [Battery on page 49](#))
  - c. Fan (see [Fan on page 74](#))
  - d. Keyboard (see [Keyboard on page 58](#))
  - e. Base enclosure (see [Internal base enclosure on page 68](#))

Remove the card reader board:

1. Disconnect the larger card reader cable **(1)** and the smaller touchpad cable **(2)** from the the card reader board.
2. Using a thin tool, pry up the left side of the board to disengage it from the top cover **(3)**.

3. Remove the card reader board (4).

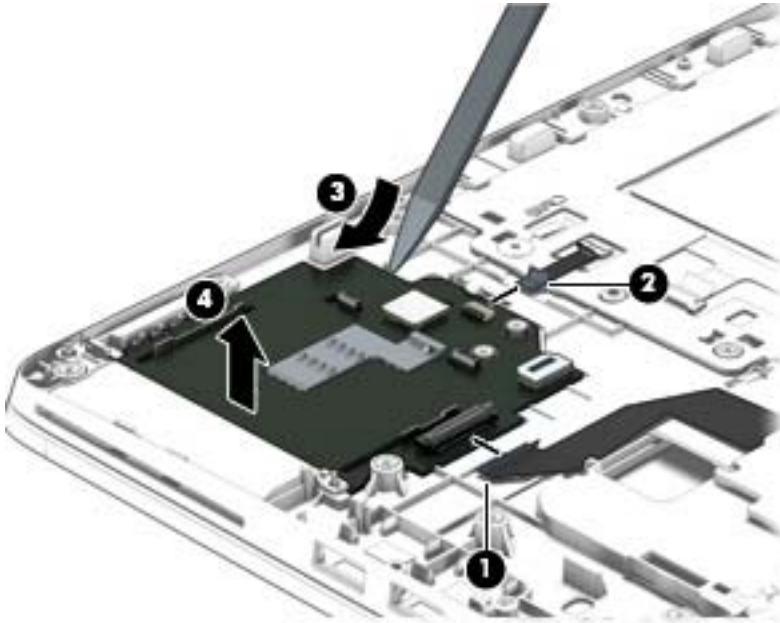

Reverse this procedure to install the card reader board.



## VGA/USB board

Description	Spare part number
VGA/USB board for use in HP EliteBook 745 models	768792-001
VGA/USB board for use in HP EliteBook 755 models	773961-001

Before removing the VGA/USB board, follow these steps:

1. Turn off the computer. If you are unsure whether the computer is off or in Hibernation, turn the computer on, and then shut it down through the operating system.
2. Disconnect the power from the computer by unplugging the power cord from the computer.
3. Disconnect all external devices from the computer.
4. Remove the following components:
  - a. Service door (see [Service door on page 47](#))
  - b. Battery (see [Battery on page 49](#))
  - c. Fan (see [Fan on page 74](#))
  - d. Keyboard (see [Keyboard on page 58](#))
  - e. Base enclosure (see [Internal base enclosure on page 68](#))

Remove the VGA/USB board:

### Removing the VGA/USB board for HP EliteBook 745 models

1. Disconnect the cable from the VGA/USB board **(1)**.
2. Remove the two Phillips PM2.0×5.0 screws **(2)** that secure the VGA/USB board to the top cover.

3. Remove the VGA/USB board from the top cover **(3)**.

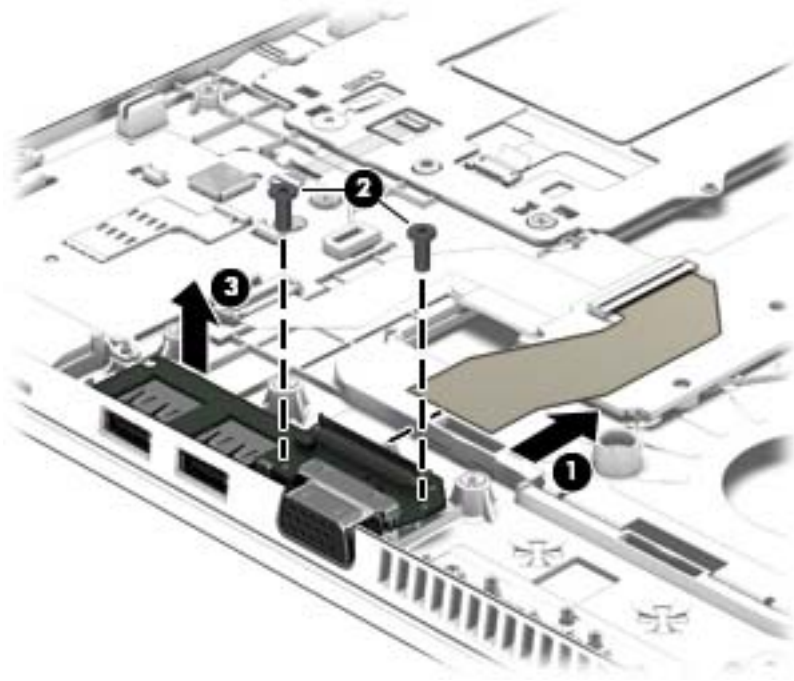

#### Removing the VGA/USB board for HP EliteBook 755 models

1. Disconnect the cable from the VGA/USB board **(1)**.
2. Remove the three Phillips PM2.0×5.0 screws **(2)** that secure the VGA/USB board to the top cover.
3. Remove the VGA/USB board from the top cover **(3)**.

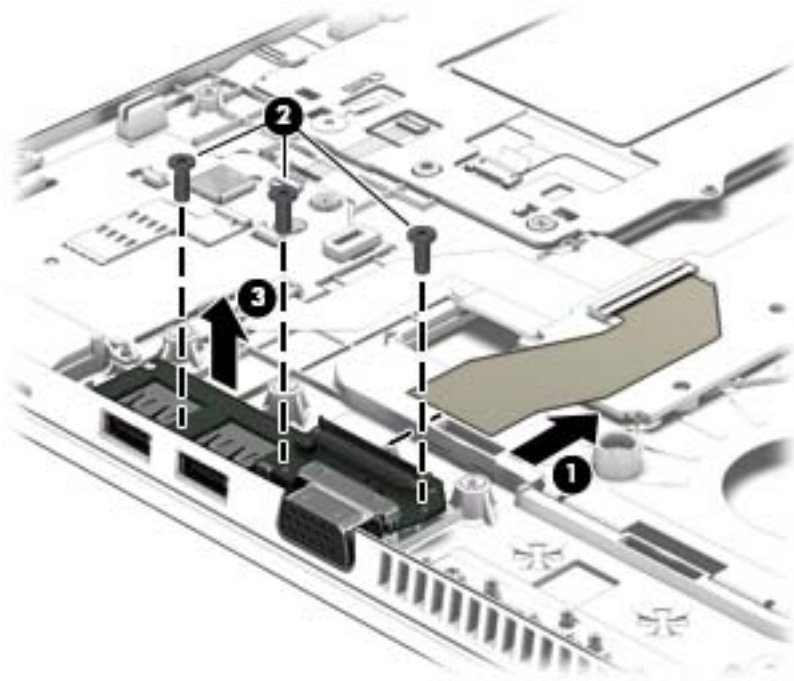

Reverse this procedure to install the VGA/USB board.

## Heat sink



**NOTE:** The heat sink spare part kit includes replacement thermal material.

Description	Spare part number
For use only on HP EliteBook 745 models	768790-001
For use only on HP EliteBook 755 models	773959-001

Before removing the heat sink, follow these steps:

1. Turn off the computer. If you are unsure whether the computer is off or in Hibernation, turn the computer on, and then shut it down through the operating system.
2. Disconnect the power from the computer by unplugging the power cord from the computer.
3. Disconnect all external devices from the computer.
4. Remove the following components:
  - a. Service door (see [Service door on page 47](#))
  - b. Battery (see [Battery on page 49](#))
  - c. Fan (see [Fan on page 74](#))
  - d. Keyboard (see [Keyboard on page 58](#))
  - e. Base enclosure (see [Internal base enclosure on page 68](#))

Remove the heat sink:

1. Following the 1, 2, 3, 4 sequence stamped into the heat sink, loosen the four captive Phillips screws **(1)** – **(4)** that secure the heat sink to the system board, and then remove the heat sink **(5)**.



**NOTE:** Due to the adhesive quality of the thermal material located between the heat sink and the system board components, it may be necessary to move the heat sink from side to side to detach it.

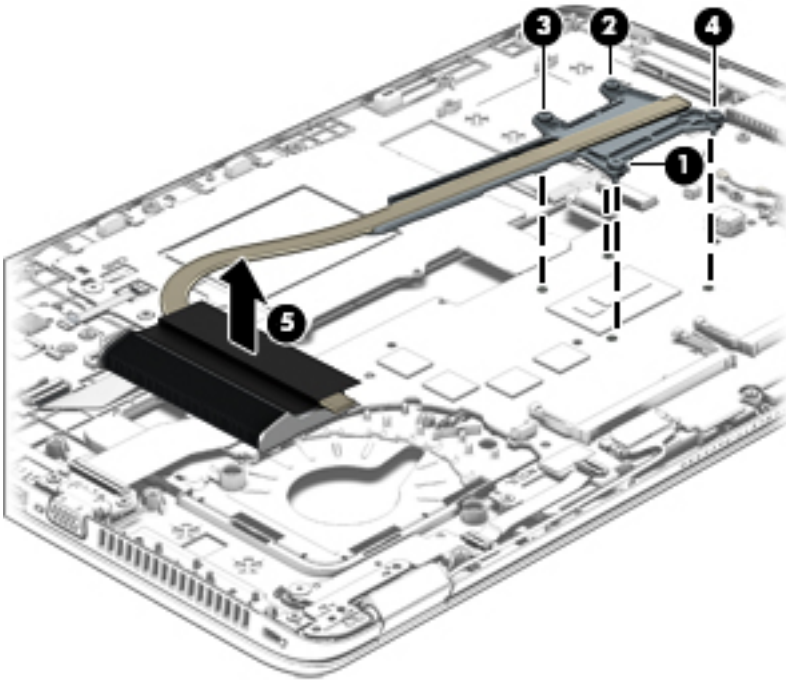

2. The following illustration shows the replacement thermal material locations. The thermal material must be thoroughly cleaned from the surfaces of the heat sink and the system board components each time the heat sink is removed. Replacement thermal material is included with the heat sink, processor, and system board spare part kits.

Thermal paste is used on the system board component **(1)** and on the heat sink area **(2)** that services it.

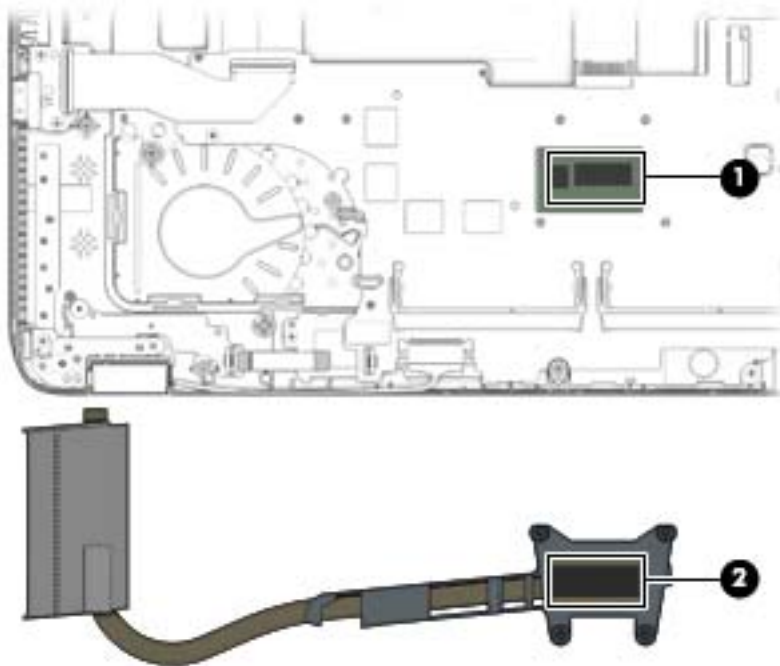

Reverse this procedure to install the heat sink.

## Power button board

Description	Spare part number
Power button board for use in HP EliteBook 745 models	730959-001
Power button board for use in HP EliteBook 755 models	730822-001

Before removing the power button board, follow these steps:

1. Turn off the computer. If you are unsure whether the computer is off or in Hibernation, turn the computer on, and then shut it down through the operating system.
2. Disconnect the power from the computer by unplugging the power cord from the computer.
3. Disconnect all external devices from the computer.
4. Remove the following components:
  - a. Service door (see [Service door on page 47](#))
  - b. Battery (see [Battery on page 49](#))
  - c. Fan (see [Fan on page 74](#))
  - d. Keyboard (see [Keyboard on page 58](#))
  - e. Base enclosure (see [Internal base enclosure on page 68](#))
  - f. Heat sink (see [Heat sink on page 79](#))

Remove the power button board:

1. Disconnect the power button board cable from the power button board **(1)**.
2. Remove the broadhead Phillips PM2.0×3.0 screw that secures the board **(2)** to the top cover.

3. Slide the power button board toward the inside of the top cover, and then lift it off the top cover **(3)**.

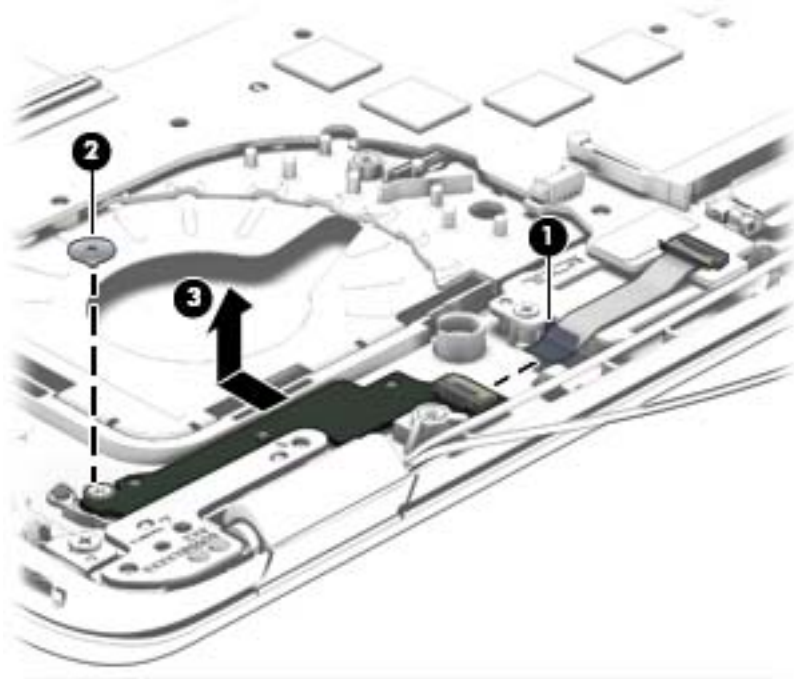

Reverse this procedure to install the power button board.

## Fingerprint reader assembly

Description	Spare part number
Fingerprint reader assembly for use in HP EliteBook 745 models (includes cable, bracket, and insulator)	730956-001
Fingerprint reader assembly for use in HP EliteBook 755 models (includes cable, bracket, and insulator)	730817-001

Before removing the fingerprint reader assembly, follow these steps:

1. Turn off the computer. If you are unsure whether the computer is off or in Hibernation, turn the computer on, and then shut it down through the operating system.
2. Disconnect the power from the computer by unplugging the power cord from the computer.
3. Disconnect all external devices from the computer.
4. Remove the following components:
  - a. Service door (see [Service door on page 47](#))
  - b. Battery (see [Battery on page 49](#))
  - c. Fan (see [Fan on page 74](#))
  - d. Keyboard (see [Keyboard on page 58](#))
  - e. Base enclosure (see [Internal base enclosure on page 68](#))

Remove the fingerprint reader assembly:

1. Turn the computer upside down.
2. Remove plastic cover from the fingerprint reader assembly **(1)**.
3. Slide the bracket away from the fingerprint reader board **(2)**, and remove it.

4. Remove the fingerprint reader board **(3)** from the computer.

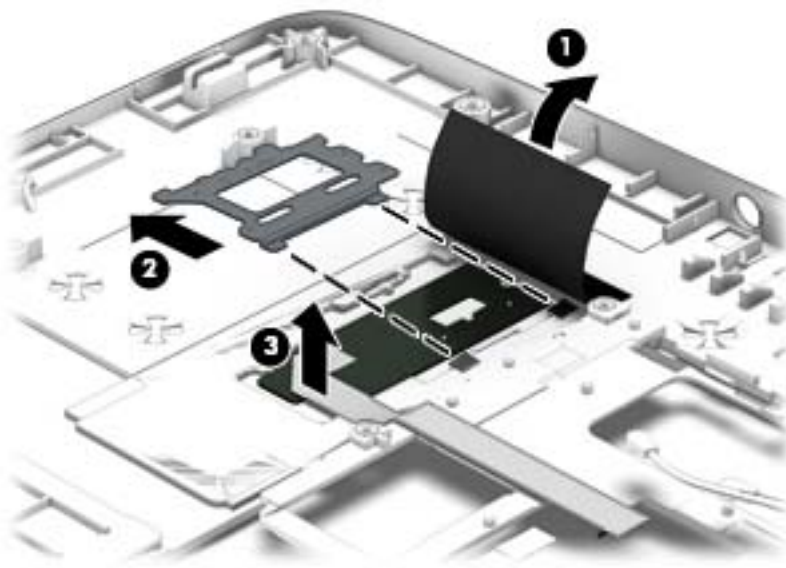

Reverse this procedure to install the fingerprint reader assembly.



## System board

 **NOTE:** The system board spare part kit includes replacement thermal material.

 **IMPORTANT:** For system board replacement on serial numbers xxx501xxxx and below, you must use a conversion kit (see product description for “(Gold Conversion Kit)”). For serial numbers xxx502xxxx and above, use the standard spare kit (see product description for “(Gold)”).

Description	Spare part number
<b>System board</b> (includes replacement thermal material):	
For use on models with AMD A6-7050B G2 processor for use with the Windows 8.1 Professional operating system (Gold)	802541-601
For use on models with AMD A6-7050B G2 processor for use with the Windows 8.1 Standard operating system (Gold)	802541-501
For use on models with AMD A6-7050B G2 processor for use with models without the Windows 8.1 operating system (Gold)	802541-001
For use on models with AMD A8-7150B G2 processor for use with the Windows 8.1 Professional operating system (Gold)	802542-601
For use on models with AMD A8-7150B G2 processor for use with the Windows 8.1 Standard operating system (Gold)	802542-501
For use on models with AMD A8-7150B G2 processor for use with models without the Windows 8.1 operating system (Gold)	802542-001
For use on models with AMD A10-7350B G2 processor for use with the Windows 8.1 Professional operating system (Gold)	802543-601
For use on models with AMD A10-7350B G2 processor for use with the Windows 8.1 Standard operating system (Gold)	802543-501
For use on models with AMD A10-7350B G2 processor for use with models without the Windows 8.1 operating system (Gold)	802543-001
<b>System board (Gold Conversion Kits)</b> (includes replacement thermal material):	
For use on models with AMD A6-7050B G2 processor for use with the Windows 8.1 Professional operating system (Gold Conversion Kit)	802541-6C1
For use on models with AMD A6-7050B G2 processor for use with the Windows 8.1 Standard operating system (Gold Conversion Kit)	802541-5C1
For use on models with AMD A6-7050B G2 processor for use with models without the Windows 8.1 operating system (Gold Conversion Kit)	802541-0C1
For use on models with AMD A8-7150B G2 processor for use with the Windows 8.1 Professional operating system (Gold Conversion Kit)	802542-6C1
For use on models with AMD A8-7150B G2 processor for use with the Windows 8.1 Standard operating system (Gold Conversion Kit)	802542-5C1
For use on models with AMD A8-7150B G2 processor for use with models without the Windows 8.1 operating system (Gold Conversion Kit)	802542-0C1
For use on models with AMD A10-7350B G2 processor for use with the Windows 8.1 Professional operating system (Gold Conversion Kit)	802543-6C1

Description	Spare part number
For use on models with AMD A10-7350B G2 processor for use with the Windows 8.1 Standard operating system (Gold Conversion Kit)	802543-5C1
For use on models with AMD A10-7350B G2 processor for use with models without the Windows 8.1 operating system (Gold Conversion Kit)	802543-0C1

Before removing the system board, follow these steps:

1. Turn off the computer. If you are unsure whether the computer is off or in Hibernation, turn the computer on, and then shut it down through the operating system.
2. Disconnect the power from the computer by unplugging the power cord from the computer.
3. Disconnect all external devices from the computer.
4. Remove the following components:
  - a. Service door (see [Service door on page 47](#))
  - b. Battery (see [Battery on page 49](#))
  - c. Hard drive (see [Hard drive on page 50](#))
  - d. Fan (see [Fan on page 74](#))
  - e. Keyboard (see [Keyboard on page 58](#))
  - f. Base enclosure (see [Internal base enclosure on page 68](#))

When replacing the system board, be sure that the following components are removed from the defective system board and installed on the replacement system board:

- Memory modules (see [Memory module on page 52](#))
- Heat sink (see [Heat sink on page 79](#))



**NOTE:** You do not have to remove the heat sink to remove the system board.

- WLAN module (see [WLAN module on page 56](#))
- WWAN module (see [WWAN module on page 54](#))

Remove the system board:

1. Position the computer upright and open as far as possible.

2. Release the ZIF connector **(1)** to which the fingerprint reader cable is connected, and then disconnect the fingerprint reader cable **(2)** from the system board.

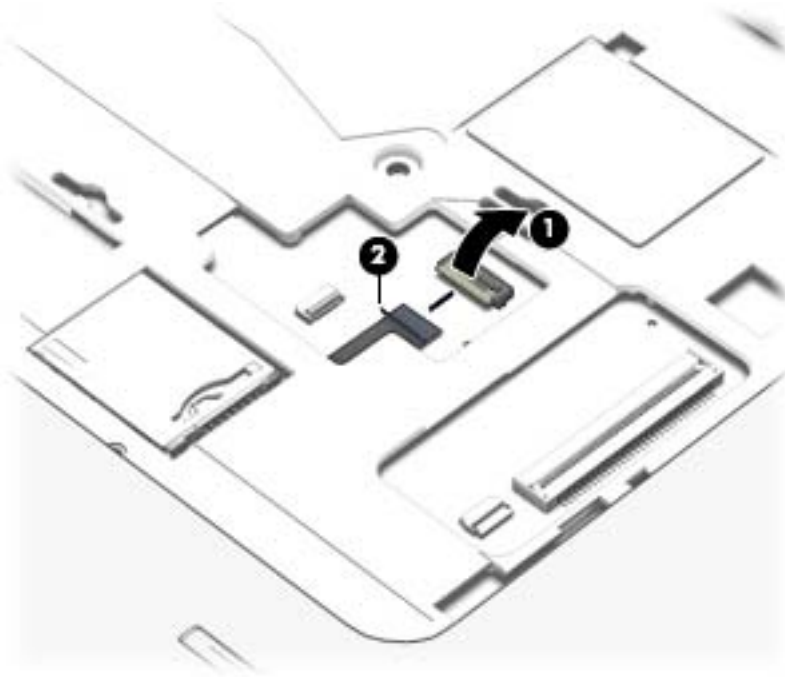

3. Close the computer and position it upside down.
4. Disconnect the smart card reader cable **(1)** from the smart card reader.
5. Disconnect the VGA/USB board cable **(2)** from the system board.
6. Disconnect the power button board cable **(3)** from the system board.
7. Release the display panel cable from the routing channel **(4)** attached to the system board, and then disconnect the display panel cable **(5)** from the system board.
8. Disconnect the speaker cable **(6)** from the system board.

9. Note the routing location of the antenna cables (7) when removing them.

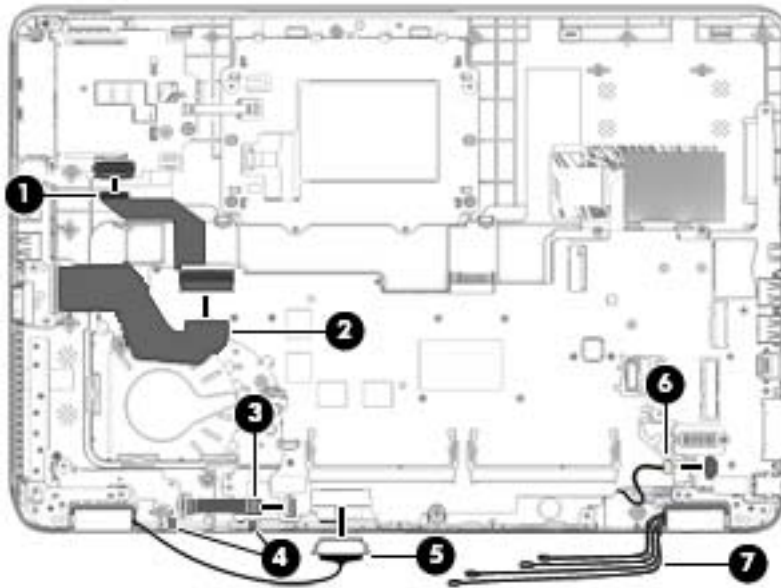

10. Remove the three Phillips PM2.5×5.0 screws that secure the system board to the top cover.

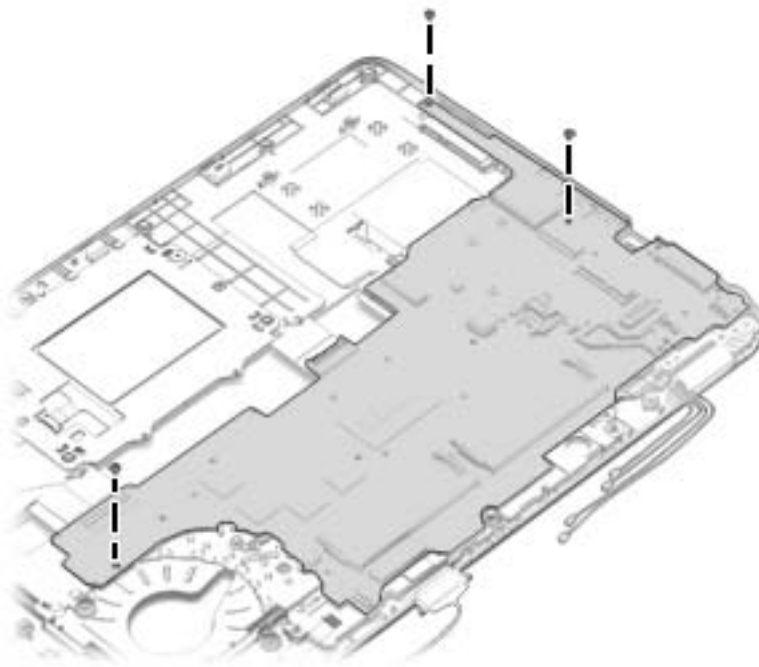

11. Lift the left side of the system board (1).

12. Remove the system board **(2)** by sliding it up and to the left at an angle.

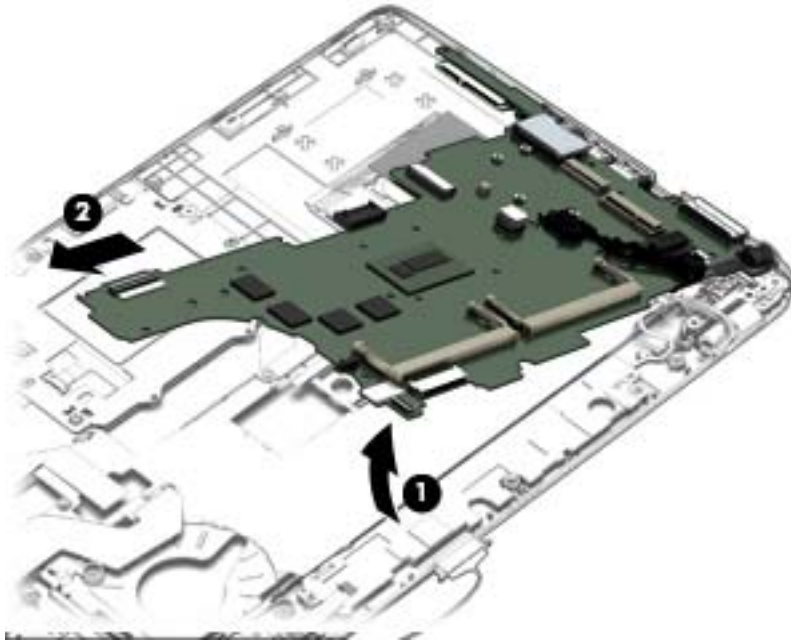

Reverse this procedure to install the system board.

## Speaker assembly

Description	Spare part number
Speaker assembly (includes cable)	730798-001

Before removing the speaker assembly, follow these steps:

1. Turn off the computer. If you are unsure whether the computer is off or in Hibernation, turn the computer on, and then shut it down through the operating system.
2. Disconnect the power from the computer by unplugging the power cord from the computer.
3. Disconnect all external devices from the computer.
4. Remove the battery (see [Battery on page 49](#)), and then remove the following components:
  - a. Service door (see [Service door on page 47](#))
  - b. Battery (see [Battery on page 49](#))
  - c. Hard drive (see [Hard drive on page 50](#))
  - d. WWAN module (see [WWAN module on page 54](#))
  - e. WLAN module (see [WLAN module on page 56](#))
  - f. Fan (see [Fan on page 74](#))
  - g. Keyboard (see [Keyboard on page 58](#))
  - h. Base enclosure (see [Internal base enclosure on page 68](#))
  - i. System board (see [System board on page 85](#))

Remove the speaker assembly:

1. Position the top cover upside down.
2. Remove the two Phillips PM2.0×3.0 screws **(1)** that secure the speaker assembly to the base enclosure.

3. Remove the speaker assembly **(2)** from the top cover.

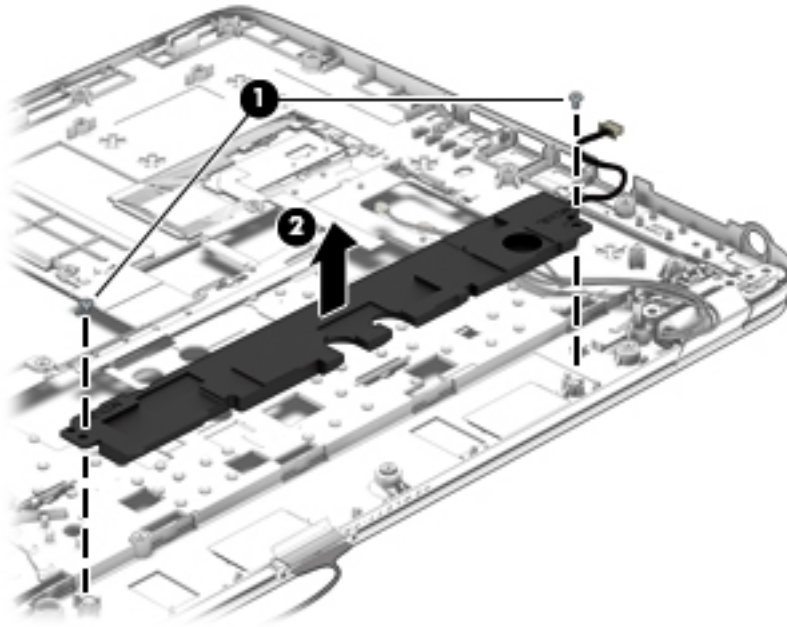

Reverse this procedure to install the speaker assembly.

## Display assembly

 **NOTE:** Non-touch displays are spared at the subcomponent level only. Touch displays are only spared as a whole (touch display components are not spared).

In non-touch models, you can remove the raw display panel with the display assembly still connected to the computer. For more information, see [Display panel \(non-touch\) on page 63](#).

The following section shows how to remove the raw display panel without removing the display assembly from the computer. See the display section later in this chapter to remove internal components that require that you remove the display assembly.

Description	Spare part number
<b>Display assembly, touch screen (whole assembly)</b>	
15 in, FHD, for use in HP EliteBook 755 models	774990-001
14 in, FHD, for use in HP EliteBook 745 models	777325-001
<b>Display enclosure (non-touch models) (includes 4 transceivers with antennas)</b>	
Display bezel for use in HP EliteBook 745 models	779682-001
Display bezel for use in HP EliteBook 755 models	779686-001
<b>Display hinges:</b>	
For use in HP EliteBook 745 models	730957-001
For use in HP EliteBook 755 models	730819-001
<b>Antenna Kit (includes antenna cables and transceivers):</b>	
For use in HP EliteBook 745 models	780080-001
For use in HP EliteBook 755 models	780081-001

Before removing the display assembly, follow these steps:

1. Turn off the computer. If you are unsure whether the computer is off or in Hibernation, turn the computer on, and then shut it down through the operating system.
2. Disconnect the power from the computer by unplugging the power cord from the computer.
3. Disconnect all external devices from the computer.
4. Remove the following components:
  - a. Service door (see [Service door on page 47](#))
  - b. Battery (see [Battery on page 49](#))
  - c. Fan (see [Fan on page 74](#))
  - d. Keyboard (see [Keyboard on page 58](#))
  - e. Base enclosure (see [Internal base enclosure on page 68](#))

Remove the display assembly:



1. Disconnect the display panel cable (1) from the system board.
2. Release the wireless antenna cables (2) from the routing channel attached to the system board.

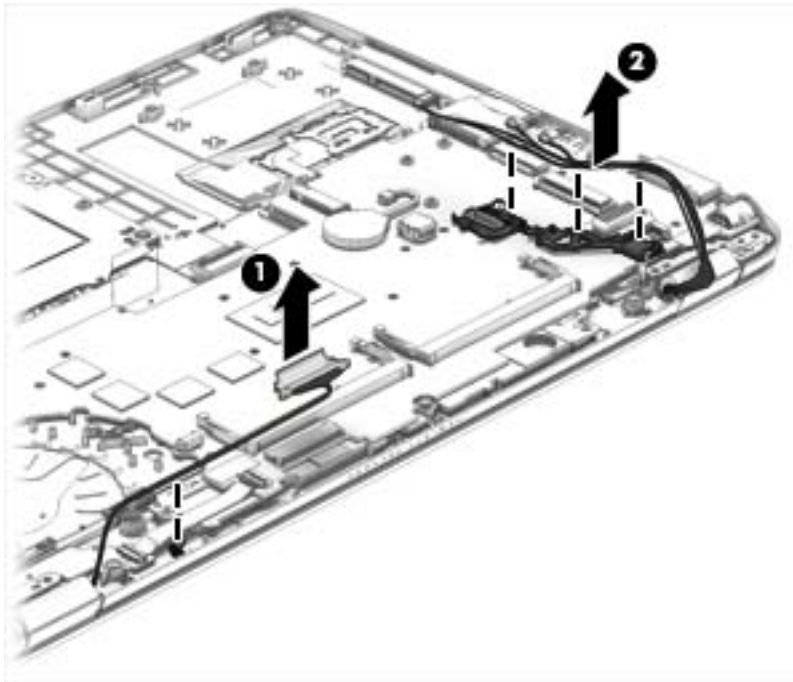

3. Remove the four Torx TM2.5×6.0 screws (1) that secure the display panel to the computer.
4. Rotate the display hinges upward to an angle (2) until the top cover is free for removal.
5. Separate the display from the top cover (3).

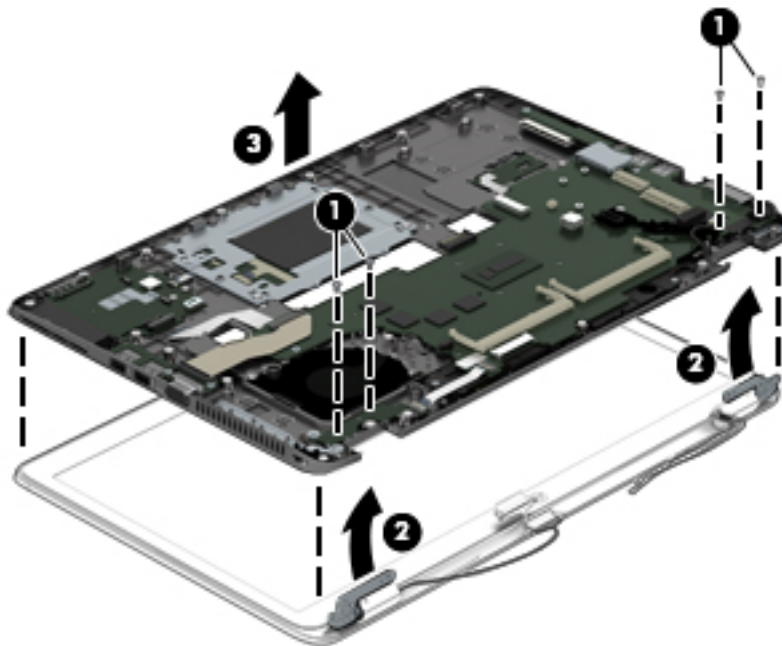

6. If you need to remove the bezel, lift to disengage the bezel on the bottom (1), left and right sides (2), and top (3).

7. Remove the bezel from the display assembly (4).

 **NOTE:** In these steps, the display assembly will not be connected to the computer as shown in the illustration.

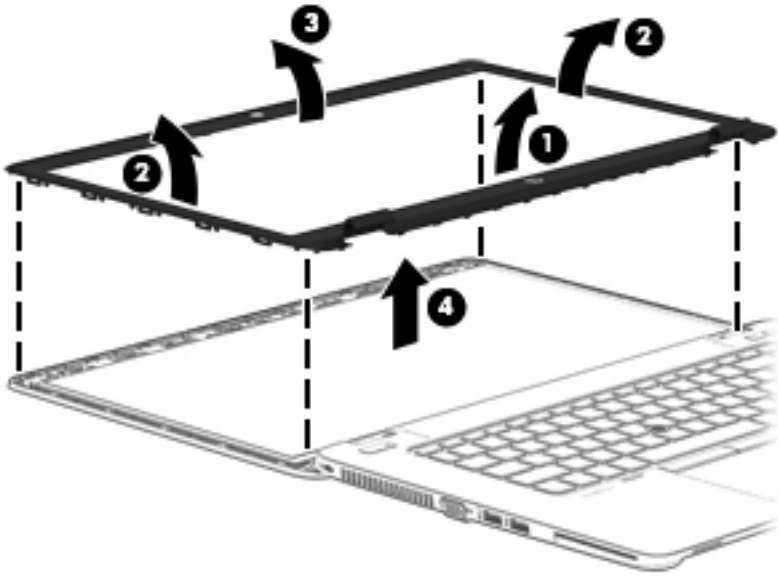

8. If you need to remove the raw display panel, remove the four Phillips PM2.0×3.0 screws (1) that secure the display panel to the display enclosure.
9. Lift and rotate the panel onto the computer (2).

 **NOTE:** In these steps, the display assembly will not be connected to the computer as shown in the illustration.

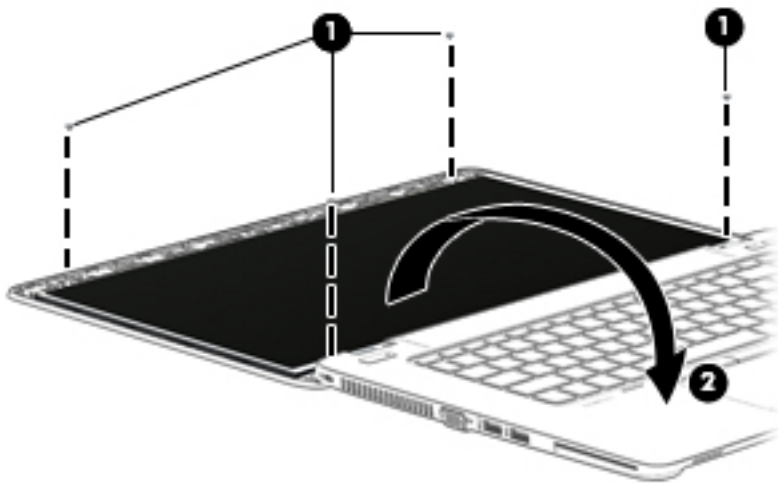

10. Lift the tape that secures the display cable to the display panel (1), and the disconnect the display cable from the panel (2).

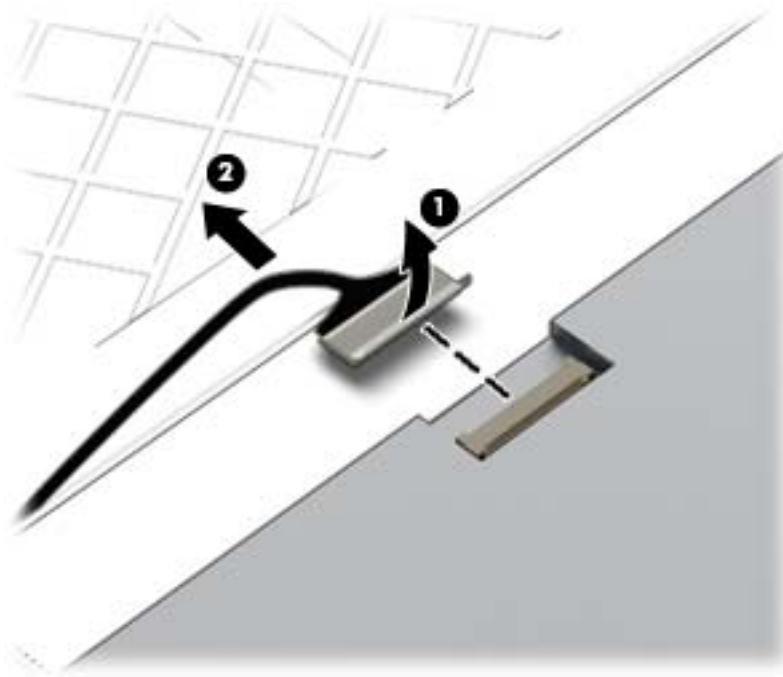

11. Lift the display panel from the display enclosure.

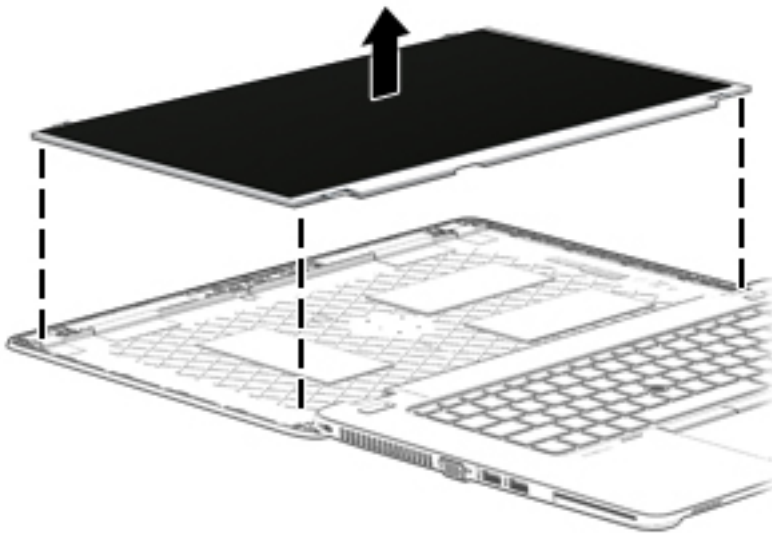

12. If you need to replace the webcam/microphone module:
- Release the tape that secures the webcam cable to the module (1).
  - Disconnect the cable (2) from the module.

**CAUTION:** Handle the module with caution. The module has a thin profile and is susceptible to damage when not handled carefully.

- c. Remove the module **(3)** from the display enclosure. (The module is attached to the display enclosure with double-sided tape.)

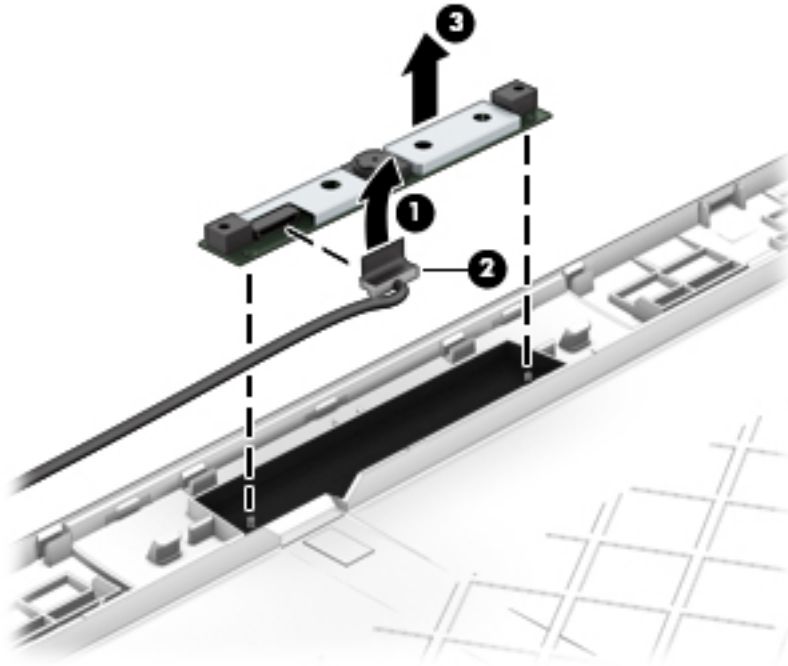

13. If you need to remove the display hinges, remove the six broadhead Phillips PM 2.0×2.0 screws **(1)**, and then lift the hinges from the display enclosure **(2)**.

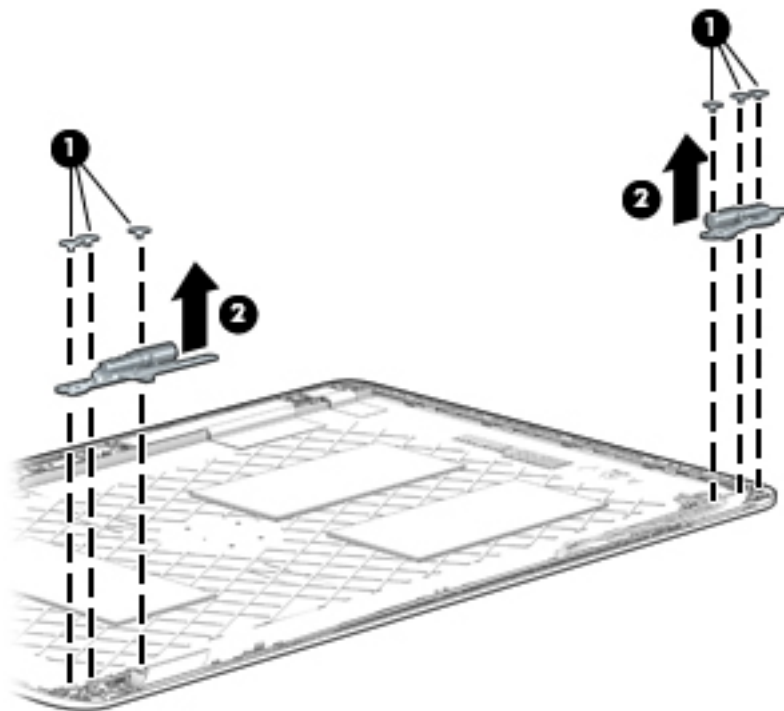

14. If you need to remove the display cable, lift the cable straight up and out of the display enclosure. Use the following image to properly route the cable.

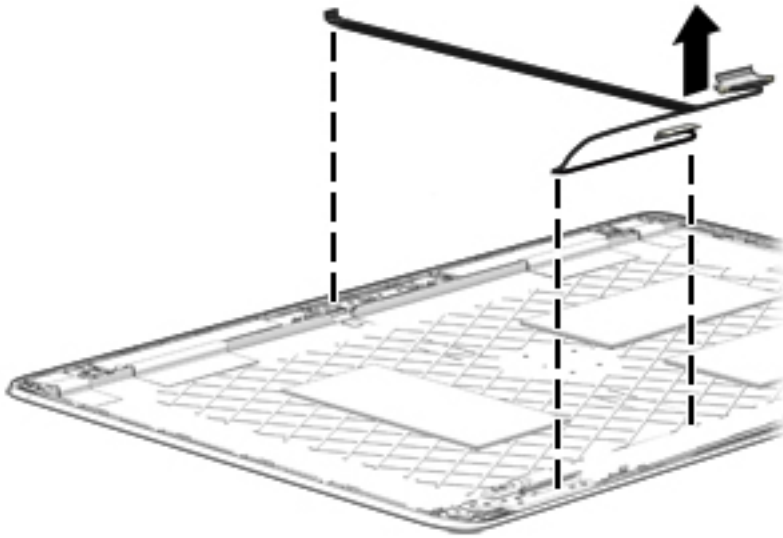

15. If you need to replace the WLAN/WWAN antenna cables and transceivers:
- Release the antenna cables from the clips (1) and routing channel built into the display enclosure.
  - Detach the WLAN antennas and transceivers (2) and the WWAN antennas and transceivers (3) from the display enclosure.

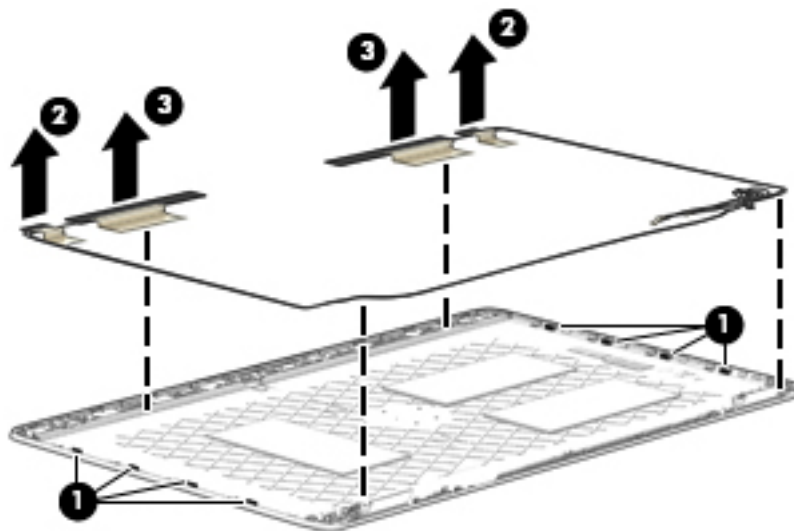

Reverse this procedure to reassemble and install the display assembly.



---

# 7 Computer Setup (BIOS), MultiBoot, and System Diagnostics in Windows 8.1

## Using Computer Setup

Computer Setup, or Basic Input/Output System (BIOS), controls communication between all the input and output devices on the system (such as disk drives, display, keyboard, mouse, and printer). Computer Setup includes settings for the types of devices installed, the startup sequence of the computer, and the amount of system and extended memory.

---

 **NOTE:** Use extreme care when making changes in Computer Setup. Errors can prevent the computer from operating properly.

---

## Starting Computer Setup

---

 **NOTE:** An external keyboard or mouse connected to a USB port can be used with Computer Setup only if USB legacy support is enabled.

---

To start Computer Setup, follow these steps:

1. Turn on or restart the computer, and then press **esc** while the “Press the ESC key for Startup Menu” message is displayed at the bottom of the screen.
2. Press **f10** to enter Computer Setup.

## Navigating and selecting in Computer Setup

To navigate and select in Computer Setup, follow these steps:

1. Turn on or restart the computer, and then press **esc** while the “Press the ESC key for Startup Menu” message is displayed at the bottom of the screen.

---

 **NOTE:** You can use either a pointing device (TouchPad, pointing stick, or USB mouse) or the keyboard to navigate and make selections in Computer Setup.

---

2. Press **f10** to enter Computer Setup.

- To select a menu or a menu item, use the **tab** key and the keyboard arrow keys and then press **enter**, or use a pointing device to click the item.
- To scroll up and down, click the up arrow or the down arrow in the upper-right corner of the screen, or use the up arrow key or the down arrow key on the keyboard.
- To close open dialog boxes and return to the main Computer Setup screen, press **esc**, and then follow the on-screen instructions.

To exit Computer Setup menus, choose one of the following methods:

- To exit Computer Setup menus without saving your changes:  
Click the **Exit** icon in the lower-right corner of the screen, and then follow the on-screen instructions.  
– or –  
Use the arrow keys to select **Main > Ignore Changes and Exit**, and then press **enter**.
- To save your changes and exit Computer Setup menus:  
Click the **Save** icon in the lower-right corner of the screen, and then follow the on-screen instructions.  
– or –  
Use the arrow keys to select **Main > Save Changes and Exit**, and then press **enter**.

Your changes go into effect when the computer restarts.

## Restoring factory settings in Computer Setup



**NOTE:** Restoring defaults will not change the hard drive mode.

To return all settings in Computer Setup to the values that were set at the factory, follow these steps:

1. Turn on or restart the computer, and then press **esc** while the “Press the ESC key for Startup Menu” message is displayed at the bottom of the screen.
2. Press **f10** to enter Computer Setup.
3. Use a pointing device or the arrow keys to select **Main > Restore Defaults**.
4. Follow the on-screen instructions.
5. To save your changes and exit, click the **Save** icon in the lower-right corner of the screen, and then follow the on-screen instructions.

– or –

Use the arrow keys to select **Main > Save Changes and Exit**, and then press **enter**.

Your changes go into effect when the computer restarts.



**NOTE:** Your password settings and security settings are not changed when you restore the factory settings.

## Updating the BIOS

Updated versions of the BIOS may be available on the HP website.



Most BIOS updates on the HP website are packaged in compressed files called *SoftPaqs*.

Some download packages contain a file named *Readme.txt*, which contains information regarding installing and troubleshooting the file.

## Determining the BIOS version

To determine whether available BIOS updates contain later BIOS versions than those currently installed on the computer, you need to know the version of the system BIOS currently installed.

BIOS version information (also known as *ROM date* and *System BIOS*) can be displayed by pressing **fn+esc** (if you are already in Windows) or by using Computer Setup.

1. Start Computer Setup.
2. Use a pointing device or the arrow keys to select **Main > System Information**.
3. To exit Computer Setup without saving your changes, click the **Exit** icon in the lower-right corner of the screen, and then follow the on-screen instructions.

– or –

Use the arrow keys to select **Main > Ignore Changes and Exit**, and then press **enter**.

## Downloading a BIOS update

 **CAUTION:** To reduce the risk of damage to the computer or an unsuccessful installation, download and install a BIOS update only when the computer is connected to reliable external power using the AC adapter. Do not download or install a BIOS update while the computer is running on battery power, docked in an optional docking device, or connected to an optional power source. During the download and installation, follow these instructions:

Do not disconnect power on the computer by unplugging the power cord from the AC outlet.

Do not shut down the computer or initiate Sleep.

Do not insert, remove, connect, or disconnect any device, cable, or cord.

1. From the Start screen, type `hp support assistant`, and then select the HP Support Assistant app.
2. Select **Updates and tune-ups**, and then select **Check for HP updates now**.
3. At the download area, follow these steps:
  - a. Identify the most recent BIOS update and compare it to the BIOS version currently installed on your computer. Make a note of the date, name, or other identifier. You may need this information to locate the update later, after it has been downloaded to your hard drive.
  - b. Follow the on-screen instructions to download your selection to the hard drive.

If the update is more recent than your BIOS, make a note of the path to the location on your hard drive where the BIOS update is downloaded. You will need to access this path when you are ready to install the update.

 **NOTE:** If you connect your computer to a network, consult the network administrator before installing any software updates, especially system BIOS updates.

BIOS installation procedures vary. Follow any instructions that are displayed on the screen after the download is complete. If no instructions are displayed, follow these steps:

1. From the Start screen, type `file`, and then select **File Explorer**.
2. Click your hard drive designation. The hard drive designation is typically Local Disk (C:).
3. Using the hard drive path you recorded earlier, open the folder on your hard drive that contains the update.
4. Double-click the file that has an `.exe` extension (for example, `filename.exe`).  
The BIOS installation begins.
5. Complete the installation by following the on-screen instructions.



---

**NOTE:** After a message on the screen reports a successful installation, you can delete the downloaded file from your hard drive.

---

## Using MultiBoot

### About the boot device order

As the computer starts, the system attempts to boot from enabled devices. The MultiBoot utility, which is enabled at the factory, controls the order in which the system selects a boot device. Boot devices can include optical drives, diskette drives, a network interface card (NIC), hard drives, and USB devices. Boot devices contain bootable media or files that the computer needs to start and operate properly.



---

**NOTE:** Some boot devices must be enabled in Computer Setup before they can be included in the boot order.

---

You can change the order in which the computer searches for a boot device by changing the boot order in Computer Setup. You can also press `esc` while the “Press the ESC key for Startup Menu” message is displayed at the bottom of the screen, and then press `f9`. Pressing `f9` displays a menu that shows the current boot devices and allows you to select a boot device. Or, you can use MultiBoot Express to set the computer to prompt you for a boot location each time the computer turns on or restarts.

### Choosing MultiBoot preferences

You can use MultiBoot in the following ways:

- To set a new boot order that the computer uses each time it is turned on, by changing the boot order in Computer Setup.
- To dynamically choose the boot device, by pressing `esc` while the “Press the ESC key for Startup Menu” message is displayed at the bottom of the screen, and then pressing `f9` to enter the Boot Device Options menu.
- To use MultiBoot Express to set variable boot orders. This feature prompts you for a boot device each time the computer is turned on or restarted.

### Setting a new boot order in Computer Setup

To start Computer Setup and set a boot device order that the computer uses each time it is turned on or restarted, follow these steps:

1. Turn on or restart the computer, and then press **esc** while the “Press the ESC key for Startup Menu” message is displayed at the bottom of the screen.
2. Press **f10** to enter Computer Setup.
3. Use a pointing device or the arrow keys to select one of the following options:
  - **Advanced > Boot Options > UEFI Boot Order > UEFI Hybrid**
  - **Advanced > Boot Options > UEFI Boot Order > UEFI Native Boot mode**
  - **Advanced > Boot Options > Legacy Boot Order > Legacy Boot Mode**Press **enter**.
4. To move the device up in the boot order, use a pointing device to click the up arrow, or press the **+** key.  
– or –  
To move the device down in the boot order, use a pointing device to click the down arrow, or press the **-** key.
5. To save your changes and exit Computer Setup, click the **Save** icon in the lower-left corner of the screen, and then follow the on-screen instructions.  
– or –  
Use the arrow keys to select **Main > Save Changes and Exit**, and then press **enter**.

## Dynamically choosing a boot device using the f9 prompt

To dynamically choose a boot device for the current startup sequence, follow these steps:

1. Open the Select Boot Device menu by turning on or restarting the computer, and then pressing **esc** while the “Press the ESC key for Startup Menu” message is displayed at the bottom of the screen.
2. Press **f9**.
3. Use a pointing device or the arrow keys to select a boot device, then press **enter**.

## Setting a MultiBoot Express prompt

To start Computer Setup and set the computer to display the MultiBoot startup location menu each time the computer is started or restarted, follow these steps:

1. Turn on or restart the computer, and then press **esc** while the “Press the ESC key for Startup Menu” message is displayed at the bottom of the screen.
2. Press **f10** to enter Computer Setup.
3. Use a pointing device or the arrow keys to select **Advanced > Boot Options > Multiboot Express Boot Popup Delay (Sec)**, and then press **enter**.

4. In the **MultiBoot Express Popup Delay (Sec)** field, enter the length of time in seconds that you want the computer to display the startup location menu before it defaults to the current MultiBoot setting. (When 0 is selected, the Express Boot startup location menu is not displayed.)
5. To save your changes and exit Computer Setup, click the **Save** icon in the lower-left corner of the screen, and then follow the on-screen instructions.

– or –

Use the arrow keys to select **Main > Save Changes and Exit**, and then press **enter**.

Your changes go into effect when the computer restarts.

## Entering MultiBoot Express preferences

When the Express Boot menu is displayed during startup, you have the following choices:

- To specify a boot device from the Express Boot menu, select your preference within the allotted time, and then press **enter**.
- To prevent the computer from defaulting to the current MultiBoot setting, press any key before the allotted time expires. The computer will not start until you select a boot device and press **enter**.
- To allow the computer to start according to the current MultiBoot settings, wait for the allotted time to expire.

## Using HP PC Hardware Diagnostics (UEFI) (select models only)

HP PC Hardware Diagnostics is a Unified Extensible Firmware Interface (UEFI) that allows you to run diagnostic tests to determine if the computer hardware is functioning properly. The tool runs outside of the operating system to isolate hardware failures from issues that may be caused by the operating system or other software components.

To start HP PC Hardware Diagnostics UEFI:

1. Turn on or restart the computer, quickly press **esc**, and then press **f2**.

After pressing **f2**, the BIOS searches three places for the HP PC Hardware Diagnostics (UEFI) tools in the following order:

- a. Connected USB drive

---

 **NOTE:** To download the HP PC Hardware Diagnostics (UEFI) tool to a USB drive, see [Downloading HP PC Hardware Diagnostics \(UEFI\) to a USB device on page 105](#).

---

- b. Hard drive

- c. BIOS

2. Click the type of diagnostic test you want to run, and then follow the on-screen instructions.

---

 **NOTE:** If you need to stop a diagnostic test while it is running, press **esc**.

---

## Downloading HP PC Hardware Diagnostics (UEFI) to a USB device



**NOTE:** The HP PC Hardware Diagnostics (UEFI) download instructions are provided in English only.

---

1. Go to <http://www.hp.com>.
2. Point to **Support**, located at the top of the page, and then click the **Download Drivers**.
3. In the text box, enter the product name in the text box, and then click **Go**.

— or —

Click **Find Now** to let HP automatically detect your product.

4. Select your computer model, and then select your operating system.
5. In the Diagnostic section, click **HP UEFI Support Environment**.

– or –

Click **Download**, and then select **Run**.



---

# 8 Computer Setup (BIOS) and HP PC Hardware Diagnostics (UEFI) in Windows 7

## Using Computer Setup

Computer Setup, or Basic Input/Output System (BIOS), controls communication between all the input and output devices on the system (such as disk drives, display, keyboard, mouse, and printer). Computer Setup includes settings for the types of devices installed, the startup sequence of the computer, and the amount of system and extended memory.

---

 **NOTE:** Use extreme care when making changes in Computer Setup. Errors can prevent the computer from operating properly.

---

## Starting Computer Setup

---

 **NOTE:** An external keyboard or mouse connected to a USB port can be used with Computer Setup only if USB legacy support is enabled.

---

To start Computer Setup, follow these steps:

1. Turn on or restart the computer, and then press **esc** while the “Press the ESC key for Startup Menu” message is displayed at the bottom of the screen.
2. Press **f10** to enter Computer Setup.

## Navigating and selecting in Computer Setup

To navigate and select in Computer Setup, follow these steps:

1. Turn on or restart the computer, and then press **esc** while the “Press the ESC key for Startup Menu” message is displayed at the bottom of the screen.

---

 **NOTE:** You can use either a pointing device (TouchPad, pointing stick, or USB mouse) or the keyboard to navigate and make selections in Computer Setup.

---

2. Press **f10** to enter Computer Setup.

- To select a menu or a menu item, use the **tab** key and the keyboard arrow keys and then press **enter**, or use a pointing device to click the item.
- To scroll up and down, click the up arrow or the down arrow in the upper-right corner of the screen, or use the up arrow key or the down arrow key on the keyboard.
- To close open dialog boxes and return to the main Computer Setup screen, press **esc**, and then follow the on-screen instructions.

To exit Computer Setup menus, choose one of the following methods:

- To exit Computer Setup menus without saving your changes:  
Click the **Exit** icon in the lower-right corner of the screen, and then follow the on-screen instructions.  
– or –  
Use the arrow keys to select **Main > Ignore Changes and Exit**, and then press **enter**.
- To save your changes and exit Computer Setup menus:  
Click the **Save** icon in the lower-right corner of the screen, and then follow the on-screen instructions.  
– or –  
Use the arrow keys to select **Main > Save Changes and Exit**, and then press **enter**.

Your changes go into effect when the computer restarts.

## Restoring factory settings in Computer Setup



**NOTE:** Restoring defaults will not change the hard drive mode.

To return all settings in Computer Setup to the values that were set at the factory, follow these steps:

1. Turn on or restart the computer, and then press **esc** while the “Press the ESC key for Startup Menu” message is displayed at the bottom of the screen.
2. Press **f10** to enter Computer Setup.
3. Use a pointing device or the arrow keys to select **Main > Restore Defaults**.
4. Follow the on-screen instructions.
5. To save your changes and exit, click the **Save** icon in the lower-right corner of the screen, and then follow the on-screen instructions.

– or –

Use the arrow keys to select **Main > Save Changes and Exit**, and then press **enter**.

Your changes go into effect when the computer restarts.



**NOTE:** Your password settings and security settings are not changed when you restore the factory settings.

## Updating the BIOS

Updated versions of the BIOS may be available on the HP website.



Most BIOS updates on the HP website are packaged in compressed files called *SoftPaqs*.

Some download packages contain a file named *Readme.txt*, which contains information regarding installing and troubleshooting the file.

## Determining the BIOS version

To determine whether available BIOS updates contain later BIOS versions than those currently installed on the computer, you need to know the version of the system BIOS currently installed.

BIOS version information (also known as *ROM date* and *System BIOS*) can be displayed by pressing **fn+esc** (if you are already in Windows) or by using Computer Setup.

1. Start Computer Setup.
2. Use a pointing device or the arrow keys to select **Main > System Information**.
3. To exit Computer Setup without saving your changes, click the **Exit** icon in the lower-right corner of the screen, and then follow the on-screen instructions.

– or –

Use the arrow keys to select **Main > Ignore Changes and Exit**, and then press **enter**.

## Downloading a BIOS update

---

 **CAUTION:** To reduce the risk of damage to the computer or an unsuccessful installation, download and install a BIOS update only when the computer is connected to reliable external power using the AC adapter. Do not download or install a BIOS update while the computer is running on battery power, docked in an optional docking device, or connected to an optional power source. During the download and installation, follow these instructions:

Do not disconnect power on the computer by unplugging the power cord from the AC outlet.

Do not shut down the computer or initiate Sleep.

Do not insert, remove, connect, or disconnect any device, cable, or cord.

---

1. Access Help and Support by selecting **Start > Help and Support**.
2. Select **Updates and tune-ups**, and then select **Check for HP updates now**.
3. At the download area, follow these steps:
  - a. Identify the most recent BIOS update and compare it to the BIOS version currently installed on your computer. Make a note of the date, name, or other identifier. You may need this information to locate the update later, after it has been downloaded to your hard drive.
  - b. Follow the on-screen instructions to download your selection to the hard drive.

If the update is more recent than your BIOS, make a note of the path to the location on your hard drive where the BIOS update is downloaded. You will need to access this path when you are ready to install the update.

---

 **NOTE:** If you connect your computer to a network, consult the network administrator before installing any software updates, especially system BIOS updates.

---

BIOS installation procedures vary. Follow any instructions that are displayed on the screen after the download is complete. If no instructions are displayed, follow these steps:

1. Select **Start > Computer**.
2. Click your hard drive designation. The hard drive designation is typically Local Disk (C:).
3. Using the hard drive path you recorded earlier, open the folder on your hard drive that contains the update.
4. Double-click the file that has an .exe extension (for example, *filename.exe*).  
The BIOS installation begins.
5. Complete the installation by following the on-screen instructions.

---

 **NOTE:** After a message on the screen reports a successful installation, you can delete the downloaded file from your hard drive.

---

## Using MultiBoot

### About the boot device order

As the computer starts, the system attempts to boot from enabled devices. The MultiBoot utility, which is enabled at the factory, controls the order in which the system selects a boot device. Boot devices can include optical drives, diskette drives, a network interface card (NIC), hard drives, and USB devices. Boot devices contain bootable media or files that the computer needs to start and operate properly.

---

 **NOTE:** Some boot devices must be enabled in Computer Setup before they can be included in the boot order.

---

You can change the order in which the computer searches for a boot device by changing the boot order in Computer Setup. You can also press **esc** while the “Press the ESC key for Startup Menu” message is displayed at the bottom of the screen, and then press **f9**. Pressing **f9** displays a menu that shows the current boot devices and allows you to select a boot device. Or, you can use MultiBoot Express to set the computer to prompt you for a boot location each time the computer turns on or restarts.

### Choosing MultiBoot preferences

You can use MultiBoot in the following ways:

- To set a new boot order that the computer uses each time it is turned on, by changing the boot order in Computer Setup.
- To dynamically choose the boot device, by pressing **esc** while the “Press the ESC key for Startup Menu” message is displayed at the bottom of the screen, and then pressing **f9** to enter the Boot Device Options menu.
- To use MultiBoot Express to set variable boot orders. This feature prompts you for a boot device each time the computer is turned on or restarted.

### Setting a new boot order in Computer Setup

To start Computer Setup and set a boot device order that the computer uses each time it is turned on or restarted, follow these steps:

1. Turn on or restart the computer, and then press **esc** while the “Press the ESC key for Startup Menu” message is displayed at the bottom of the screen.
2. Press **f10** to enter Computer Setup.
3. Use a pointing device or the arrow keys to select the **Legacy Boot Order** list, and then press **enter**.
4. To move the device up in the boot order, use a pointing device to click the up arrow, or press the **+** key.  
– or –  
To move the device down in the boot order, use a pointing device to click the down arrow, or press the **-** key.
5. To save your changes and exit Computer Setup, click the **Save** icon in the lower-left corner of the screen, and then follow the on-screen instructions.  
– or –  
Use the arrow keys to select **Main > Save Changes and Exit**, and then press **enter**.

### Dynamically choosing a boot device using the f9 prompt

To dynamically choose a boot device for the current startup sequence, follow these steps:

1. Open the Select Boot Device menu by turning on or restarting the computer, and then pressing **esc** while the “Press the ESC key for Startup Menu” message is displayed at the bottom of the screen.
2. Press **f9**.
3. Use a pointing device or the arrow keys to select a boot device, then press **enter**.

### Setting a MultiBoot Express prompt

To start Computer Setup and set the computer to display the MultiBoot startup location menu each time the computer is started or restarted, follow these steps:

1. Turn on or restart the computer, and then press **esc** while the “Press the ESC key for Startup Menu” message is displayed at the bottom of the screen.
2. Press **f10** to enter Computer Setup.
3. Use a pointing device or the arrow keys to select **System Configuration > Boot Options**, and then press **enter**.
4. In the **MultiBoot Express Popup Delay (Sec)** field, enter the length of time in seconds that you want the computer to display the startup location menu before it defaults to the current MultiBoot setting. (When 0 is selected, the Express Boot startup location menu is not displayed.)
5. To save your changes and exit Computer Setup, click the **Save** icon in the lower-left corner of the screen, and then follow the on-screen instructions.  
– or –  
Use the arrow keys to select **Main > Save Changes and Exit**, and then press **enter**.

Your changes go into effect when the computer restarts.

## Entering MultiBoot Express preferences

When the Express Boot menu is displayed during startup, you have the following choices:

- To specify a boot device from the Express Boot menu, select your preference within the allotted time, and then press **enter**.
- To prevent the computer from defaulting to the current MultiBoot setting, press any key before the allotted time expires. The computer will not start until you select a boot device and press **enter**.
- To allow the computer to start according to the current MultiBoot settings, wait for the allotted time to expire.

## Using HP PC Hardware Diagnostics (UEFI) (select models only)

HP PC Hardware Diagnostics is a Unified Extensible Firmware Interface (UEFI) that allows you to run diagnostic tests to determine if the computer hardware is functioning properly. The tool runs outside of the operating system to isolate hardware failures from issues that may be caused by the operating system or other software components.

To start HP PC Hardware Diagnostics UEFI:

1. Turn on or restart the computer, quickly press **esc**, and then press **f2**.

After pressing **f2**, the BIOS searches three places for the HP PC Hardware Diagnostics (UEFI) tools in the following order:

- a. Connected USB drive

---

 **NOTE:** To download the HP PC Hardware Diagnostics (UEFI) tool to a USB drive, see [Downloading HP PC Hardware Diagnostics \(UEFI\) to a USB device on page 105](#).

---

- b. Hard drive

- c. BIOS

2. Click the type of diagnostic test you want to run, and then follow the on-screen instructions.

---

 **NOTE:** If you need to stop a diagnostic test while it is running, press **esc**.

---

## Downloading HP PC Hardware Diagnostics (UEFI) to a USB device

---

 **NOTE:** The HP PC Hardware Diagnostics (UEFI) download instructions are provided in English only.

---

1. Go to <http://www.hp.com>.
2. Point to **Support**, located at the top of the page, and then click the **Download Drivers**.
3. In the text box, enter the product name in the text box, and then click **Go**.

— or —

Click **Find Now** to let HP automatically detect your product.

4. Select your computer model, and then select your operating system.
  5. In the Diagnostic section, click **HP UEFI Support Environment**.
- or –
- Click **Download**, and then select **Run**.



---

# 9 Using Setup Utility (BIOS) and System Diagnostics in Ubuntu

Setup Utility, or Basic Input/Output System (BIOS), controls communication between all the input and output devices on the system (such as disk drives, display, keyboard, mouse, and printer). Setup Utility includes settings for the types of peripherals installed, the startup sequence of the computer, and the amount of system and extended memory.



**NOTE:** Use extreme care when making changes in Setup Utility. Errors can prevent the computer from operating properly.

---

## Starting Setup Utility

- ▲ Turn on or restart the computer. While the “Press the ESC key for Startup Menu” message is displayed in the lower-left corner of the screen, press `esc`. When the Startup menu is displayed, press `f10`.

## Using Setup Utility

### Changing the language of Setup Utility

1. Start Setup Utility.
2. Use the arrow keys to select **System Configuration > Language**, and then press `enter`.
3. Use the arrow keys to select a language, and then press `enter`.
4. When a confirmation prompt with your language selected is displayed, press `enter`.
5. To save your change and exit Setup Utility, use the arrow keys to select **Exit > Exit Saving Changes**, and then press `enter`.

Your change takes effect immediately.

### Navigating and selecting in Setup Utility

Setup Utility does not support the TouchPad. Navigation and selection are by keystroke.

- To choose a menu or a menu item, use the arrow keys.
- To choose an item in a list or to toggle a field—for example an Enable/Disable field—use either the arrow keys or `f5` and `f6`.
- To select an item, press `enter`.

- To close a text box or return to the menu display, press `esc`.
- To display additional navigation and selection information while Setup Utility is open, press `f1`.

## Displaying system information

1. Start Setup Utility.
2. Select the **Main** menu. System information such as the system time and date, and identification information about the computer is displayed.
3. To exit Setup Utility without changing any settings, use the arrow keys to select **Exit > Exit Discarding Changes**, and then press `enter`.

## Restoring factory default settings in Setup Utility

1. Start Setup Utility.
2. Use the arrow keys to select **Exit > Load Setup Defaults**, and then press `enter`.
3. When the Setup Confirmation is displayed, press `enter`.
4. To save your change and exit Setup Utility, use the arrow keys to select **Exit > Exit Saving Changes**, and then press `enter`.

The Setup Utility factory settings take effect when the computer restarts.



**NOTE:** Your password, security, and language settings are not changed when you restore the factory settings.

## Exiting Setup Utility

- To exit Setup Utility and save your changes from the current session:  
If the Setup Utility menus are not visible, press `esc` to return to the menu display. Then use the arrow keys to select **Exit > Exit Saving Changes**, and then press `enter`.
- To exit Setup Utility without saving your changes from the current session:  
If the Setup Utility menus are not visible, press `esc` to return to the menu display. Then use the arrow keys to select **Exit > Exit Discarding Changes**, and then press `enter`.

## Using HP PC Hardware Diagnostics (UEFI)

HP PC Hardware Diagnostics is a Unified Extensible Firmware Interface (UEFI) that allows you to run diagnostic tests to determine whether the computer hardware is functioning properly. The tool runs outside of the operating system so that it can isolate hardware failures from issues that are caused by the operating system or other software components.

To start HP PC Hardware Diagnostics UEFI:

1. Turn on or restart the computer, quickly press `esc`, and then press `f2`.

The BIOS searches two places for the diagnostic tool in the following order:

- a. Connected USB drive



---

 **NOTE:** To download the HP PC Hardware Diagnostics (UEFI) tool to a USB drive, see [Downloading HP PC Hardware Diagnostics \(UEFI\) to a USB device on page 105](#).

---

- b.** BIOS
- 2.** When the diagnostic tool opens, use the keyboard arrow keys to select the type of diagnostic test you want to run, and then follow the on-screen instructions.

---

 **NOTE:** If you need to stop a diagnostic test while it is running, press *esc*.

---

## Downloading HP PC Hardware Diagnostics (UEFI) to a USB device

---

 **NOTE:** The HP PC Hardware Diagnostics (UEFI) download instructions are provided in English only, and you must use a Windows computer to download and create the HP UEFI support environment because only .exe files are offered.

---

There are two options to download HP PC Hardware Diagnostics to a USB device:

**Option 1: HP PC Diagnostics homepage**—Provides access to the latest UEFI version

- 1.** Go to <http://hp.com/go/techcenter/pcdiags>.
- 2.** Click the **UEFI Download** link, and then select **Run**.

**Option 2: Support and Drivers page**—Provides downloads for a specific product for earlier and later versions

- 1.** Go to <http://www.hp.com>.
- 2.** Point to **Support**, located at the top of the page, and then click the **Download Drivers**.
- 3.** In the text box, enter the product name, and then click **Go**.

— or —

Click **Find Now** to let HP automatically detect your product.

- 4.** Select your computer model, and then select your operating system.
- 5.** In the **Diagnostic** section, click **HP UEFI Support Environment**.

— or —

Click **Download**, and then select **Run**.



---

# 10 Backup and recovery in Windows 8.1

To protect your information, use Windows backup and restore utilities to back up individual files and folders, back up your entire hard drive, create system repair media (select models only) by using the installed optical drive (select models only) or an optional external optical drive, or create system restore points. In case of system failure, you can use the backup files to restore the contents of your computer.

From the Start screen, type *restore*, click **Settings**, and then select from the list of displayed options.

---

 **NOTE:** For detailed instructions on various backup and restore options, perform a search for these topics in HP Support Assistant. To access HP Support Assistant on the Start screen, select the **HP Support Assistant** app.

In case of system instability, HP recommends that you print the recovery procedures and save them for later use.

 **NOTE:** Windows includes the User Account Control feature to improve the security of your computer. You may be prompted for your permission or password for tasks such as installing software, running utilities, or changing Windows settings. Refer to HP Support Assistant. To access HP Support Assistant on the Start screen, select the **HP Support Assistant** app.

---

## Backing up your information

Recovery after a system failure is as good as your most recent backup. You should create system repair media and your initial backup immediately after initial system setup. As you add new software and data files, you should continue to back up your system on a regular basis to maintain a reasonably current backup. For more information on the Windows backup features, see Windows Help and Support.

## Performing a system recovery

In case of system failure or instability, the computer provides the following tools to recover your files:

- **Windows recovery tools:** You can use Windows Backup and Restore to recover information you have previously backed up. You can also use Windows Automatic Repair to fix problems that might prevent Windows from starting correctly.
- **f11 recovery tools:** You can use the **f11** recovery tools to recover your original hard drive image. The image includes the Windows operating system and software programs installed at the factory.

---

 **NOTE:** If you are unable to boot (start up) your computer and you cannot use the system repair media you previously created (select models only), you must purchase Windows 8.1 operating system media to reboot the computer and repair the operating system. For additional information, see [Using Windows 8.1 operating system media \(purchased separately\) on page 121](#).

---

## Using the Windows recovery tools

To recover information you previously backed up, see Windows Help and Support for steps on restoring files and folders.

To recover your information using Automatic Repair, follow these steps:

---

 **CAUTION:** Some Automatic Repair options will completely erase and reformat the hard drive. All files you have created and any software installed on the computer are permanently removed. When reformatting is complete, the recovery process restores the operating system, as well as the drivers, software, and utilities from the backup used for recovery.

---

1. If possible, back up all personal files.
2. If possible, check for the presence of the HP Recovery partition and the Windows partition.

From the Start screen, type `file`, and then click **File Explorer**.

– or –

From the Start screen, type `pc`, and then select **This PC**.

---

 **NOTE:** If the Windows partition and the HP Recovery partition are not listed, you must recover your operating system and programs using the Windows 8.1 operating system DVD and the *Driver Recovery* media (both purchased separately). For additional information, see [Using Windows 8.1 operating system media \(purchased separately\) on page 121](#).

---

3. If the Windows partition and the Recovery Image partition are listed, restart the computer by pressing and holding the `shift` key while clicking **Restart**.
4. Select **Troubleshoot**, then select **Advanced Options**, and then select **Startup Repair**.
5. Follow the on-screen instructions.

---

 **NOTE:** For additional information on recovering information using the Windows tools, perform a search for these topics in Windows Help and Support.

---

## Using f11 recovery tools

---

 **CAUTION:** Using `f11` completely erases hard drive contents and reformats the hard drive. All files that you have created and any software that you have installed on the computer are permanently removed. The `f11` recovery tool reinstalls the operating system and HP programs and drivers that were installed at the factory. Software not installed at the factory must be reinstalled.

---

To recover the original hard drive image using `f11`:

1. If possible, back up all personal files.
2. If possible, check for the presence of the Recovery Image partition: From the Start screen, type `pc`, and then select **This PC**.

---

 **NOTE:** If the HP Recovery partition is not listed, you must recover your operating system and programs using the Windows 8.1 operating system media and the *Driver Recovery* media (both purchased separately). For additional information, see [Using Windows 8.1 operating system media \(purchased separately\) on page 121](#).

---

3. If the Recovery Image partition is listed, restart the computer, and then press **esc** while the “Press the ESC key for Startup Menu” message is displayed at the bottom of the screen.
4. Press **f11** while the “Press <F11> for recovery” message is displayed on the screen.
5. Follow the on-screen instructions.

## Using Windows 8.1 operating system media (purchased separately)

To order a Windows 8.1 operating system DVD, contact support. See the *Worldwide Telephone Numbers* booklet included with the computer. You can also find contact information from the HP website. Go to <http://www.hp.com/support>, select your country or region, and follow the on-screen instructions.

---

 **CAUTION:** Using a Windows 8.1 operating system media completely erases hard drive contents and reformats the hard drive. All files that you have created and any software that you have installed on the computer are permanently removed. When reformatting is complete, the recovery process helps you restore the operating system, as well as drivers, software, and utilities.

---

To initiate recovery using a Windows 8.1 operating system DVD:

---

 **NOTE:** This process takes several minutes.

---

1. If possible, back up all personal files.
2. Restart the computer, and then insert the Windows 8.1 operating system DVD into the optical drive before the Windows operating system loads.
3. When prompted, press any keyboard key.
4. Follow the on-screen instructions.

After the installation is completed:

1. Eject the Windows 8.1 operating system media and then insert the *Driver Recovery* media.
2. Install the Hardware Enabling Drivers first, and then install Recommended Applications.

## Using Windows Refresh or Windows Reset

When your computer is not working properly and you need to regain system stability, the Windows Refresh option allows you to start fresh and keep what is important to you.

The Windows Reset option allows you to perform detailed reformatting of your computer, or remove personal information before you give away or recycle your computer. The process described in this section provides a speedy, simple way to return the computer to its original state. This option removes all personal data, apps, and settings from your computer, and reinstalls Windows.

For more information on these features, see Windows Help and Support.

## Using HP Software Setup

HP Software Setup can be used to reinstall drivers or select software that has been corrupted or deleted from the system.

1. From the Start screen, type `HP Software Setup`.
2. Open HP Software Setup.
3. Follow the on-screen directions to reinstall drivers or select software.

---

# 11 Backup and recovery in Windows 7

Your computer includes HP and Windows tools to help you safeguard your information and retrieve it if you ever need to. These tools will help you return your computer to a proper working state, all with simple steps. This section provides information about the following processes:

- Creating recovery media and backups
- Restoring and recovering your system

## Creating recovery media and backups

Recovery after a system failure is only as good as your most recent backup.

1. After you successfully set up the computer, create HP Recovery media. This step creates a Windows 7 operating system DVD and a *Driver Recovery* DVD. The Windows DVD can be used to reinstall the original operating system in cases where the hard drive is corrupted or has been replaced. The *Driver Recovery* DVD installs specific drivers and applications. See [Creating recovery media with HP Recovery Disc Creator on page 124](#).
2. Use Windows Backup and Recovery tools to perform the following:
  - Back up individual files and folders
  - Back up your entire hard drive (select models only)
  - Create system repair discs (select models only) with the installed optical drive (select models only) or an optional external optical drive
  - Create system restore points



---

**NOTE:** This guide describes an overview of backing up, restoring, and recovering options. For more details about the tools provided, see Help and Support. To access Help and Support, select **Start > Help and Support**.



**NOTE:** HP recommends that you print the recovery procedures and save them for later use, in case of system instability.

---

In case of system failure, you can use the backup files to restore the contents of your computer. See [Backing up your information on page 124](#).

## Guidelines

- When creating recovery media or backing up to discs, use any of the following types of discs (purchased separately): DVD+R, DVD+R DL, DVD-R, DVD-R DL, or DVD±RW. The discs you use will depend on the type of optical drive you are using.
- Be sure that the computer is connected to AC power before you start the recovery media creation process or the backup process.

## Creating recovery media with HP Recovery Disc Creator

HP Recovery Disc Creator is a software program that offers an alternative way to create recovery media. After you successfully set up the computer, you can create recovery media using HP Recovery Disc Creator. This recovery media allows you to reinstall your original operating system as well as select drivers and applications if the hard drive becomes corrupted. HP Recovery Disc Creator can create two kinds of recovery DVDs:

- **Windows 7 operating system DVD**—Installs the operating system without additional drivers or applications.
- **Driver Recovery DVD**—Installs specific drivers and applications only, in the same way that the HP Software Setup utility installs drivers and applications.

## Creating recovery media

 **NOTE:** The Windows 7 operating system DVD can be created only once. Thereafter, the option to create that media will not be available after you create a Windows DVD.

To create the Windows DVD:

1. Select **Start > All Programs > Productivity and Tools > HP Recovery Disc Creator**.
2. Select **Windows disk**.
3. From the drop-down menu, select the drive for burning the recovery media.
4. Click the **Create** button to start the burning process.

After the Windows 7 operating system DVD has been created, create the *Driver Recovery* DVD:

1. Select **Start > All Programs > Productivity and Tools > HP Recovery Disc Creator**.
2. Select **Driver disk**.
3. From the drop-down menu, select the drive for burning the recovery media.
4. Click the **Create** button to start the burning process.

## Backing up your information

You should create system repair media and your initial backup immediately after initial system setup. As you add new software and data files, you should continue to back up your system on a regular basis to maintain a reasonably current backup. You should also create Windows system repair media (select models only) which can be used to start up (boot) the computer and repair the operating system in case of system instability or failure. Your initial and subsequent backups allow you to restore your data and settings if a failure occurs.

You can back up your information to an optional external hard drive, a network drive, or discs.



Note the following when backing up:

- Store personal files in the Documents library, and back it up regularly.
- Back up templates that are stored in their associated directories.
- Save customized settings that appear in a window, toolbar, or menu bar by taking a screen shot of your settings. The screen shot can be a time-saver if you have to reset your preferences.
- When backing up to discs, number each disc after removing it from the drive.

---

 **NOTE:** For detailed instructions on various backup and restore options, perform a search for these topics in Help and Support. To access Help and Support, select **Start > Help and Support**.

 **NOTE:** Windows includes the User Account Control feature to improve the security of your computer. You may be prompted for your permission or password for tasks such as installing software, running utilities, or changing Windows settings. Refer to Help and Support. To access Help and Support, select **Start > Help and Support**.

---

To create a backup using Windows Backup and Restore:

---

 **NOTE:** The backup process may take over an hour, depending on file size and the speed of the computer.

---

1. Select **Start > All Programs > Maintenance > Backup and Restore**.
2. Follow the on-screen instructions to set up your backup, create a system image (select models only), or create system repair media (select models only).

## Performing a system recovery

In case of system failure or instability, the computer provides the following tools to recover your files:

- Windows recovery tools: You can use Windows Backup and Restore to recover information you have previously backed up. You can also use Windows Startup Repair to fix problems that might prevent Windows from starting correctly.
- **f11** recovery tools (select models only): You can use the **f11** recovery tools to recover your original hard drive image. The image includes the Windows operating system and software programs installed at the factory.

---

 **NOTE:** If you are unable to boot (start up) your computer and you cannot use the system repair media you previously created (select models only), you must purchase Windows 7 operating system media to reboot the computer and repair the operating system. For additional information, see [Using Windows 8.1 operating system media \(purchased separately\) on page 121](#).

---

## Using the Windows recovery tools

Using the Windows recovery tools, you can:

- Recover individual files
- Restore the computer to a previous system restore point
- Recover information using recovery tools

---

 **NOTE:** For detailed instructions on various recovery and restore options, perform a search for these topics in Help and Support. To access Help and Support, select **Start > Help and Support**.

 **NOTE:** Windows includes the User Account Control feature to improve the security of your computer. You may be prompted for your permission or password for tasks such as installing software, running utilities, or changing Windows settings. Refer to Help and Support. To access Help and Support, select **Start > Help and Support**.

---

To recover information you previously backed up:

1. Select **Start > All Programs > Maintenance > Backup and Restore**.
2. Follow the on-screen instructions to recover your system settings, your computer (select models only), or your files.

To recover your information using Startup Repair, follow these steps:

 **CAUTION:** Some Startup Repair options will completely erase and reformat the hard drive. All files you have created and any software installed on the computer are permanently removed. When reformatting is complete, the recovery process restores the operating system, as well as the drivers, software, and utilities from the backup used for recovery.

---

1. If possible, back up all personal files.
2. If possible, check for the presence of the Windows partition.

To check for the Windows partition, select **Start > Computer**.

 **NOTE:** If the Windows partition is not listed, you must recover your operating system and programs using the Windows 7 operating system DVD and the *Driver Recovery* media. For additional information, see [Using Windows 8.1 operating system media \(purchased separately\) on page 121](#).

---

3. If the Windows partition is listed, restart the computer, and then press **f8** before the Windows operating system loads.
4. Select **Startup Repair**.
5. Follow the on-screen instructions.

 **NOTE:** For additional information on recovering information using the Windows tools, select **Start > Help and Support**.

---

## Using f11 recovery tools (select models only)

---

 **CAUTION:** Using **f11** completely erases hard drive contents and reformats the hard drive. All files that you have created and any software that you have installed on the computer are permanently removed. The **f11** recovery tool reinstalls the operating system and HP programs and drivers that were installed at the factory. Software not installed at the factory must be reinstalled.

---

To recover the original hard drive image using **f11**:

1. If possible, back up all personal files.
2. If possible, check for the presence of the HP Recovery partition: click **Start**, right-click **Computer**, click **Manage**, and then click **Disk Management**.

---

 **NOTE:** If the HP Recovery partition is not listed, you must recover your operating system and programs using the Windows 7 operating system media and the *Driver Recovery* media. For additional information, see [Using Windows 8.1 operating system media \(purchased separately\) on page 121](#).

---

3. If the HP Recovery partition is listed, restart the computer, and then press **esc** while the “Press the ESC key for Startup Menu” message is displayed at the bottom of the screen.
4. Press **f11** while the “Press <F11> for recovery” message is displayed on the screen.
5. Follow the on-screen instructions.

## Using Windows 7 operating system media

If you cannot use the recovery media you previously created using the HP Recovery Disc Creator (select models only), you must purchase a Windows 7 operating system DVD to reboot the computer and repair the operating system.

To order a Windows 7 operating system DVD, go to the HP website. For U.S. support, go to <http://www.hp.com/support>. For worldwide support, go to [http://welcome.hp.com/country/us/en/wwcontact\\_us.html](http://welcome.hp.com/country/us/en/wwcontact_us.html). You can also order the DVD by calling support. For contact information, see the *Worldwide Telephone Numbers* booklet included with the computer.

---

 **CAUTION:** Using a Windows 7 operating system DVD completely erases hard drive contents and reformats the hard drive. All files that you have created and any software that you have installed on the computer are permanently removed. When reformatting is complete, the recovery process helps you restore the operating system, as well as drivers, software, and utilities.

---

To initiate recovery using a Windows 7 operating system DVD:

---

 **NOTE:** This process takes several minutes.

---

1. If possible, back up all personal files.
2. Restart the computer, and then insert the Windows 7 operating system DVD into the optical drive before the Windows operating system loads.
3. When prompted, press any keyboard key.
4. Follow the on-screen instructions.
5. Click **Next**.

6. Select **Repair your computer**.
7. Follow the on-screen instructions.

After the repair is completed:

1. Eject the Windows 7 operating system DVD and then insert the *Driver Recovery* DVD.
2. Install the Hardware Enabling Drivers first, and then install Recommended Applications.

---

# 12 Backing up, restoring, and recovering in Ubuntu

Recovery after a system failure is as good as your most recent backup. As you add new software and data files, you should continue to back up your system on a regular basis to maintain a reasonably current backup.

## Creating a restore image

The Recovery Media Creator allows you to repair or restore the computer to its original factory state. You can create restore image DVDs using DVD±RW optical drives. You can also create a restore image on a USB device.

---

 **CAUTION:** Using Restore completely erases hard drive contents and reformats the hard drive. All files you have created and any software installed on the computer are permanently removed. The recovery tool reinstalls the original operating system and programs and drivers that were installed at the factory. Software, drivers, and updates not installed at the factory must be manually reinstalled. Your data files and personal files must be restored from a backup.

 **NOTE:** HP recommends that you create the restore image in the event of a system failure.

---

## Creating restore image on DVDs

You can use Recovery Media Creator or the restore creation software to create a set of system restore discs using blank, writable DVDs (DVD-R or DVD+R). HP recommends using blank DVD+R discs from a manufacturer you trust, because these recovery DVDs are so important. You need approximately 3 blank DVD+R discs available for the restore image. If you use more than one disc, label each disc with the order in which it was created. Numbering the discs will ensure that you have them in the correct order if you need to restore the computer to its original factory state.

To create restore DVDs using the Recovery Media Creator:

1. Click the **Dash Home** icon at the far left of the top panel, and then enter `recovery` in the Search box. Select **Recovery Media Creator**.
2. On the **Please choose media type** window, click the **DVD** icon.
3. Follow the on-screen instructions.

To create restore DVDs using the restore creation software:

1. Click the **System menu** icon at the far right of the top panel, and then click **System Settings > Backup**.
2. Select **Storage** from the panel on the left side of the window, click the down-arrow next to **Backup Location**, select the Local Folder, and then click the **Choose Folder** button. Select the DVD from the panel on the left side of the window, and click **OK**.
3. Select **Overview** from the panel on the left side of the window, and then click **Back Up Now**.
4. Follow the on-screen instructions.

## Creating a restore image on a USB device

---

 **NOTE:** Be sure AC power is connected to the computer you begin this procedure.

---

You can use Recovery Media Creator or the restore creation software to create a system restore image on a USB device. Verify the exact amount of free space on your storage device before you begin the creation process. For most models, you will need at least 4 GB of free space on the USB device. However, depending on the drivers and software installed on your computer, you may need slightly more than 4 GB of space. **HP recommends that you use an 8 GB device or above for best results.**

---

 **IMPORTANT:** Remember to insert your USB device into the USB port on the computer before starting this procedure.

---

To create a restore USB device using the Recovery Media Creator:

1. Click the **Dash Home** icon at the far left of the top panel, and then enter `recovery` in the Search box. Select **Recovery Media Creator**.
2. On the **Please choose media type** window, click the **USB** icon.
3. Follow the on-screen instructions.

To create a restore USB device using restore creation software:

1. Click the **System menu** icon at the far right of the top panel, and then click **System Settings > Backup**.
2. Select **Storage** from the panel on the left side of the window, click the down-arrow next to **Backup location**, select the Local Folder, and then click the **Choose Folder** button. Select the USB device from the panel on the left side of the window, and click **OK**.
3. Select **Overview** from the panel on the left side of the window, and then click **Backup Now**.
4. Follow the on-screen instructions.

## Restoring the original factory state

---

 **NOTE:** Be sure AC power is connected to the computer before you begin this procedure.

---

To use the restore image on DVDs or a USB device to restore your computer to the original factory state:

1. If possible, back up all personal files.
2. Shut down the computer.
3. Be sure the first restore DVD or USB device is connected to the computer.

4. Restart the computer.
5. When system boots, press **F9** to enter boot device selection and select the media type you are restoring from.
6. Click **Restore entire hard drive**, and then click **Continue**.
7. Follow the on-screen instructions.



**NOTE:** If you are unable to boot (start up) your computer, and you did not create a system recovery disc, you must purchase an *Ubuntu Operating System* DVD to reinstall the operating system. For additional information, refer to the *Worldwide Telephone Numbers* booklet.

---

## Backing up your data files

The Deja Dup Restore Tool allows you to back up your data files.

You should back up your data files on a regular schedule to maintain a current backup. You can manually back up your information to an optional external drive, a network drive, or discs. Back up your system at the following times:

- At regularly scheduled times
- Before the computer is repaired or restored
- Before you add or modify hardware or software

To back up your home directory files using the Deja Dup Backup Tool:



---

**NOTE:** Before you back up your information, be sure you have designated a location to save the backup files.

---

1. Click the **System menu** icon at the far right of the top panel, and then click **System Settings > Backup** icon.
2. Select **Folders** from the panel on the left side of the window, and beneath **Folders to back up**, select the folders to back up.
3. Select **Storage** from the panel on the left side of the window, click the down-arrow next to **Backup Location**, and select your designated back up location from the drop-down list.
4. Select **Overview** from the panel on the left side of the window, and then click **Back Up Now**.



---

**NOTE:** You may also back up to cloud storage services provided by various companies. For a small fee, they will keep your backup for you. A cloud service is recommended since it is an easy way to keep your backups off-site and safe.

---



## Restoring your data files

The Deja Dup Restore Tool allows you to restore your data files.



---

**NOTE:** Be sure AC power is connected to the computer before you begin this procedure.

---

To restore your data from your backup files:

1. Click the **System menu** icon at the far right of the top panel, and then click **System Settings > Backup** icon.
2. Click **Restore**, select the location of the backup files and the folder name, and then click **Forward**.
3. Under **Restore from When?**, select the date of the files to be restored and click **Forward**.
4. Select the location and folder where the files are to be restored and click **Forward**.
5. Follow the instructions on the screen.
6. Click **Restore** to start restoring the files, or click **Cancel** to cancel the operation.



# 13 Specifications

## Computer specifications—HP EliteBook 745 models

	Metric	U.S.
<b>Dimensions</b>		
Width	<b>33.9 cm</b>	13.34 in
Depth	<b>23.7 cm</b>	9.33 in
Height	<b>2.1 cm</b>	0.83 in
Height (touch models)	<b>2.16 cm</b>	0.85 in
<b>Weight</b>		
Non-touch panel: Equipped with 3 cell (24 Whr) battery, UMA graphics, one memory module, WLAN module, and solid-state drive	<b>1.61 kg</b>	3.55 lbs
Touch panel: Equipped with 3 cell (24 Whr) battery, UMA graphics, one memory module, WLAN module, and solid-state drive	<b>1.77 kg</b>	3.91 lbs
Non-touch panel: Equipped with 3 cell (50 Whr) battery, UMA graphics, one memory module, WLAN module, and solid-state drive	<b>1.70 kg</b>	3.75 lbs
Touch panel: Equipped with 3 cell (50 Whr) battery, UMA graphics, one memory module, WLAN module, and solid-state drive	<b>1.86 kg</b>	4.11 lbs
<b>Input power</b>		
Operating voltage and current	18.5 V dc @ 3.5 A - 65 W – or – 19.0 V dc @ 2.31 A - 45 W	
<b>Temperature</b>		
Operating	<b>5°C to 35°C</b>	41°F to 95°F
Nonoperating	<b>-20°C to 60°C</b>	-4°F to 140°F
<b>Relative humidity</b> (noncondensing)		
Operating	10% to 90%	
Nonoperating	5% to 95%	

	Metric	U.S.
<b>Maximum altitude</b> (unpressurized)		
Operating	<b>-15 m to 3,048 m</b>	-50 ft to 10,000 ft
Nonoperating	<b>-15 m to 12,192 m</b>	-50 ft to 40,000 ft
<b>NOTE:</b> Applicable product safety standards specify thermal limits for plastic surfaces. The device operates well within this range of temperatures.		

## Computer specifications—HP EliteBook 755 models

	Metric	U.S.
<b>Dimensions</b>		
Width	<b>37.6 cm</b>	14.78 in
Depth	<b>25.4 cm</b>	9.98 in
Height	<b>2.15 cm</b>	0.85 in
Height (touch models)	<b>2.58 cm</b>	1.02 in
<b>Weight</b>		
Non-touch panel: equipped with 3-cell (24 Whr) battery, UMA graphics, one memory module, WLAN module, and SSD	<b>1.90 kg</b>	4.19 lbs
Touch panel: equipped with 3-cell (24 Whr) battery, UMA graphics, one memory module, WLAN module, and SSD	<b>2.12 kg</b>	4.68 lbs
Non-touch panel: equipped with 3-cell (50 Whr) battery, UMA graphics, one memory module, WLAN module, and SSD	<b>1.99 kg</b>	4.39 lbs
Touch panel: equipped with 3-cell (50 Whr) battery, UMA graphics, one memory module, WLAN module, and SSD	<b>2.21 kg</b>	4.88 lbs
<b>Input power</b>		
Operating voltage and current	18.5 V dc @ 3.5 A - 65 W	
	– or –	
	19.0 V dc @ 2.31 A - 45 W	
<b>Temperature</b>		
Operating	<b>5°C to 35°C</b>	41°F to 95°F
Nonoperating	<b>-20°C to 60°C</b>	-4°F to 140°F
<b>Relative humidity</b> (noncondensing)		
Operating	10% to 90%	
Nonoperating	5% to 95%	
<b>Maximum altitude</b> (unpressurized)		
Operating	<b>-15 m to 3,048 m</b>	-50 ft to 10,000 ft

---

	<b>Metric</b>	<b>U.S.</b>
Nonoperating	<b>-15 m to 12,192 m</b>	-50 ft to 40,000 ft

---

**NOTE:** Applicable product safety standards specify thermal limits for plastic surfaces. The device operates well within this range of temperatures.

---

## 35.6 cm (14.0 in) HD SVA display specifications

	<b>Metric</b>	<b>U.S.</b>
<b>Dimensions</b>		
Height	<b>22.43 cm</b>	8.83 in
Width	<b>36.0 cm</b>	14.17 in
Depth	<b>0.38 cm</b>	0.15 in
Diagonal	<b>35.6 cm</b>	15.6 in
<b>Weight</b>	<b>&lt; 500 g (max)</b>	< 1.1 lbs (max)
<b>Contrast ratio</b>	300:1 (typical)	
<b>Brightness</b>	<b>200 cd/m<sup>2</sup></b> (typical)	200 nits (typical)
<b>Refresh Rate</b>	60 Hz	
<b>Surface Treatment</b>	Anti-glare	
<b>Pixel resolution</b>		
Format	HD (1366 x 768)	
Configuration	RGB stripe	
<b>LCD Mode</b>	TN	
<b>PPI</b>	101 PPI	
<b>Interface</b>	eDP 1.2 (1 lane)	
<b>Viewing angle</b>	SVA 40/40/15/30 (Left/Right/Down/Up)	

## 35.6 cm (14.0 in) HD+ SVA display specifications

	<b>Metric</b>	<b>U.S.</b>
<b>Dimensions</b>		
Height	<b>20.6 cm</b>	8.09 in
Width	<b>32.1 cm</b>	12.6 in
Depth	<b>0.36 cm</b>	0.14 in
Diagonal	<b>35.6 cm</b>	14.0 in
<b>Weight</b>	<b>325 g (max)</b>	0.72 lb (max)
<b>Contrast ratio</b>	300:1 (typical)	
<b>Brightness</b>	<b>250 cd/m<sup>2</sup></b> (typical)	250 nits (typical)
<b>Refresh Rate</b>	60 Hz	
<b>Surface Treatment</b>	Anti-glare	
<b>Pixel resolution</b>		
Format	HD+ (1600 x 900)	
Configuration	RGB stripe	
<b>LCD Mode</b>	TN	
<b>PPI</b>	131 PPI	
<b>Interface</b>	eDP 1.2 (1 lane)	
<b>Viewing angle</b>	SVA 40/40/15/30 (Left/Right/Down/Up)	

## 35.6 cm (14.0 in) FHD, UWVA display specifications

	<b>Metric</b>	<b>U.S.</b>
<b>Dimensions</b>		
Height	<b>20.6 cm</b>	8.09 in
Width	<b>32.1 cm</b>	12.6 in
Depth	<b>0.36 cm</b>	0.14 in
Diagonal	<b>35.6 cm</b>	14.0 in
<b>Weight</b>	<b>340 g (max)</b>	0.75 lb (max)
<b>Contrast ratio</b>	300:1 (typical)	
<b>Brightness</b>	<b>300 cd/m<sup>2</sup></b> (typical)	300 nits (typical)
<b>Refresh Rate</b>	60 Hz	
<b>Surface Treatment</b>	Anti-glare	
<b>Pixel resolution</b>		
Format	FHD (1920 x 1080)	
Configuration	RGB stripe	
<b>LCD Mode</b>	IPS/FFS/VA	
<b>PPI</b>	157 PPI	
<b>Interface</b>	eDP 1.2 (1 lane)	
<b>Viewing angle</b>	UWVA 85/85/85/85 (Left/Right/Down/Up)	



## 39.6 cm (15.6 in) HD SVA display specifications

	<b>Metric</b>	<b>U.S.</b>
<b>Dimensions</b>		
Height	<b>20.6 cm</b>	8.09 in
Width	<b>32.1 cm</b>	12.6 in
Depth	<b>0.36 cm</b>	0.14 in
Diagonal	<b>39.6 cm</b>	14.0 in
<b>Weight</b>	< <b>500 g</b> (max)	< 1.1 lb (max)
<b>Contrast ratio</b>	300:1 (typical)	
<b>Brightness</b>	<b>200 cd/m<sup>2</sup></b> (typical)	200 nits (typical)
<b>Refresh Rate</b>	60 Hz	
<b>Surface Treatment</b>	Anti-glare	
<b>Pixel resolution</b>		
Format	HD (1366 x 768)	
Configuration	RGB stripe	
<b>LCD Mode</b>	TN	
<b>PPI</b>	125 PPI	
<b>Interface</b>	eDP 1.2 (1 lane)	
<b>Viewing angle</b>	SVA 40/40/15/30 (Left/Right/Down/Up)	

## 39.6 cm (15.6 in) FHD SVA display specifications

	<b>Metric</b>	<b>U.S.</b>
<b>Dimensions</b>		
Height	<b>20.6 cm</b>	8.09 in
Width	<b>32.1 cm</b>	12.6 in
Depth	<b>0.36 cm</b>	0.14 in
Diagonal	<b>39.6 cm</b>	14.0 in
<b>Weight</b>	< <b>380 g</b> (max)	< 0.84 lb (max)
<b>Contrast ratio</b>	400:1 (typical)	
<b>Brightness</b>	<b>300 cd/m<sup>2</sup></b> (typical)	300 nits (typical)
<b>Refresh Rate</b>	60 Hz	
<b>Surface Treatment</b>	Anti-glare	
<b>Pixel resolution</b>		
Format	HD (1920 x 1080)	
Configuration	RGB stripe	
<b>LCD Mode</b>	TN	
<b>PPI</b>	142 PPI	
<b>Interface</b>	eDP 1.2 (1 lane)	
<b>Viewing angle</b>	SVA 45/45/25/35 (Left/Right/Down/Up)	

## Hard drive specifications

	1 TB*	500 GB*	320 GB*
<b>Dimensions</b>			
Height	9.5 mm	9.5 mm	9.5 mm
Width	70 mm	70 mm	70 mm
Weight	115 g	101 g	115 g
<b>Interface type</b>			
	SATA	SATA	SATA
<b>Transfer rate</b>			
Synchronous (maximum)	Synchronous (maximum) 300 MB/s (Drive Capability)		
Security	ATA security		
<b>Seek times</b> (typical read, including setting)			
Single track	3 ms	1.5ms/3 ms	1.5 ms
Average (read/write)	13 ms	11 ms/13 ms	11 ms
Maximum	24 ms	22 ms/24 ms	22 ms
<b>Logical blocks</b>			
	1,953,525,168	976,773,168	625,142,448
<b>Disk rotational speed</b>			
	5400 rpm	5400 rpm or 7200 rpm	5400 rpm or 7200 rpm
<b>Operating temperature</b>			
	0°C to 60°C (32°F to 140°F)		
*1 GB = 1 billion bytes when referring to hard drive storage capacity. Actual accessible capacity is less.			
<b>NOTE:</b> Certain restrictions and exclusions apply. Contact technical support for details.			

## Solid-state drive specifications

	128 GB*	180 GB*	240 GB*	256 GB*
<b>Dimensions</b>				
Height	7 mm	7 mm	7 mm	7 mm
Width	70 mm	70 mm	70 mm	70 mm
Weight	73 g	78 g	78 g	73 g
<b>Interface</b>				
	SATA 3 (6 Gb/s)	SATA 3 (6 Gb/s)	SATA 3 (6 Gb/s)	SATA 3 (6 Gb/s)
<b>Transfer rate</b>				
Maximum Sequential Read	415 MB/s	Up to 550 MB/s	550 MB/s	Up to 460 MB/s
Maximum Sequential Write	175 MB/s	Up to 520 MB/s	520 MB/s	Up to 260 MB/s
<b>Total logical sectors</b>				
	250,069,680	351,651,888	468,862,128	500,118,192
<b>Features</b>				
	ATA Security; ATA-8; SATA 3.0; DIPM; TRIM	ATA Security; ATA-8; SATA 3.0; DIPM; TRIM	ATA Security; ATA-8; SATA 3.0; DIPM; TRIM	ATA Security; ATA-8 compliant; SATA 3.0; DIPM; TRIM
<b>Operating temperature</b>				
	0° to 70°C (32°F to 158°F)			
*1 GB = 1 billion bytes when referring to hard drive storage capacity. Actual accessible capacity is less.				
<b>NOTE:</b> Certain restrictions and exclusions apply. Contact technical support for details.				

---

# 14 Statement of Volatility

The purpose of this chapter is to provide general information regarding nonvolatile memory in industry-standards based HP Business Notebook PC systems and provide general instructions for restoring nonvolatile memory that can contain personal data after the system has been powered off and the hard drive has been removed.

HP Business Notebook PC products that use Intel®-based or AMD®-based system boards contain volatile DDR memory. The amount of nonvolatile memory present in the system depends upon the system configuration. Intel-based and AMD-based system boards contain nonvolatile memory subcomponents as originally shipped from HP assuming that no subsequent modifications have been made to the system and assuming that no applications, features, or functionality have been added to or installed on the system.

Following system shutdown and removal of all power sources from an HP Business Notebook PC system, personal data can remain on volatile system memory (DIMMs) for a finite period of time and will also remain in nonvolatile memory. The steps below will remove personal data from the notebook PC, including the nonvolatile memory found in Intel-based and AMD-based system boards.

1. Follow steps (a) through (j) below to restore the nonvolatile memory that can contain personal data. Restoring or re-programming nonvolatile memory that does not store personal data is neither necessary nor recommended.
  - a. Enter BIOS (F10) Setup by powering on the system and pressing **F10** when prompted near the bottom of the display, or press the **ESC** key to display the start up menu, then press **F10**. If the system has a BIOS administrator password, enter the password at the prompt.
  - b. Select **Main > Restore Defaults**.
  - c. Select the **Security** menu, and then **Restore Security Level Defaults**.
  - d. If an asset or ownership tag is set, select the **Security** menu and scroll down to the **Utilities** menu. Select **System IDs**, and the select **Asset Tracking Number**. Press the spacebar once to clear the tag, then press **Enter** to return to the prior menu.
  - e. If a DriveLock password is set, select the **Security** menu, scroll down to **Hard Drive Tools** under the **Utilities** menu, select **Hard Drive Tools**, select **DriveLock**, then uncheck **DriveLock password on restart**.
  - f. If an Automatic DriveLock password is set, select the **Security** menu, scroll down to **Hard Drive Tools** under the **Utilities** menu, select **Hard Drive Tools**, scroll down to **Automatic DriveLock**, then select the desired hard drive and disable protection. At the automatic drive lock warning screen, select **Yes** to continue. Repeat this procedure if more than one hard drive has an Automatic DriveLock password.
  - g. Select the **Main** menu, then **Reset BIOS Security to factory default**. Click **yes** at the warning message.

- h. Select the **Main** menu, then **Save Changes and Exit**.
  - i. Reboot the system. If the system has a Trusted Platform Module (TPM) and/or fingerprint sensor, one or two prompts will appear. One to clear the TPM and the other to Reset Fingerprint Sensor; press **F1** to accept or **F2** to reject.
  - j. Remove all power and system batteries for at least 24 hours.
2. Remove and retain the storage drive or clear the contents of the drive.

Clear the drive contents by using the BIOS Setup Secure Erase command option, or by using a third party utility designed to erase data from an SSD. To run Secure Erase, follow these steps:

- a. Enter BIOS Setup by powering on the system, and then pressing **F10** when prompted near the bottom of the display.
- b. Select the **Security** menu and scroll down to the **Utilities** menu.
- c. Select **Hard Drive Tools**.
- d. Under **Utilities**, select **Secure Erase**, and then select the desired hard drive.

## Non-volatile memory usage

Non Volatile Memory Type	Amount (Size)	Does this memory store customer data?	Does this memory retain data when power is removed?	What is the purpose of this memory?	How is data input into this memory?	How is this memory write protected?
HP Sure Start flash (select models only)	2 MB	No	Yes	Provides protected backup of critical System BIOS code, EC firmware, and critical PC configuration data for select platforms that support HP Sure Start.  For more information, see <a href="#">Using HP Sure Start (select models only) on page 150</a> .	Data cannot be written to this device via the host processor. The content is managed solely by the HP Sure Start Embedded Controller.	This memory is protected by the HP Sure Start Embedded Controller.
Real Time Clock (RTC) battery backed-up CMOS configuration memory (CMOS)	256 Bytes	No	Yes	Stores system date and time and limited keyboard controller data.	Using the F10 Setup utility or changing the Microsoft Windows date & time.	This memory is not write-protected. HP recommends password protecting the F10 Setup utility.

Non Volatile Memory Type	Amount (Size)	Does this memory store customer data?	Does this memory retain data when power is removed?	What is the purpose of this memory?	How is data input into this memory?	How is this memory write protected?
Controller (NIC) EEPROM	64 Kbytes (not customer accessible)	No	Yes	Store NIC configuration and NIC firmware.	Using a utility from the NIC vendor that can be run from DOS.	A utility is required to write data to this memory and is available from NIC vendor. Writing data to this ROM in an inappropriate manner will render the NIC non-functional.
Keyboard ROM	64 Kbytes (not customer accessible)	No	Yes	Stores firmware code (keyboard, mouse, & battery management).	Programmed at the factory. Code is updated when the system BIOS is updated.	A utility is required for writing data to this memory and is available on the HP website. Writing data to this ROM in an inappropriate manner can render the PC non-functional.
DIMM Serial Presence Detect (SPD) configuration data	256 Bytes per memory module, 128 Bytes programmable (not customer accessible)	No	Yes	Stores memory module information.	Programmed by the memory vendor.	Data cannot be written to this memory when the module is installed in a PC. The specific write protection method varies by memory vendor.
System BIOS	4 to 5 MBytes	Yes	Yes	Store system BIOS code and PC configuration data.	System BIOS code is programmed at the factory. Code is updated when the system BIOS is updated. Configuration data and settings are input using the F10 setup utility or a custom utility.	A utility is required for writing data to this memory and is available on the HP website. Writing data to this ROM in an inappropriate manner can render the PC non-functional.
Intel Management Engine Firmware (present only in specific ZBook and EliteBook models. For more information, go to <a href="http://www.hp.com/support">http://www.hp.com/support</a> , and select your country. Select <b>Drivers &amp; Downloads</b> , and then follow the on-screen instructions.)	1.5 or 5MByte	Yes	Yes	Stores Management Engine Code, Settings, Provisioning Data and iAMT third party data store.	Management Engine Code is programmed at the factory. Code is updated via Intel secure firmware update utility. Unique Provisioning Data can be entered at the factory or by an administrator using the Management Engine (MEBx) setup utility. The third party data store contents can be populated by a remote management console or local applications registered by an administrator to have access to the space.	The Intel chipset is configured to enforce HW protection to block all direct read/write access to this area. An Intel utility is required for updating the firmware. Only firmware updates digitally signed by Intel can be applied using this utility.

<b>Non Volatile Memory Type</b>	<b>Amount (Size)</b>	<b>Does this memory store customer data?</b>	<b>Does this memory retain data when power is removed?</b>	<b>What is the purpose of this memory?</b>	<b>How is data input into this memory?</b>	<b>How is this memory write protected?</b>
Bluetooth flash	2Mbit	No	Yes	Stores Bluetooth configuration and firmware.	Programmed at the factory. Tools for writing data to this memory are not publicly available but can be obtained from the silicon vendor.	A utility is required for writing data to this memory and is made available through newer versions of the driver if the flash requires an upgrade.
802.11 WLAN EEPROM	4kb to 8kb	No	Yes	Stores configuration and calibration data.	Programmed at the factory. Tools for writing data to this memory are not made public.	A utility is required for writing data to this memory and is typically not made available to the public unless a firmware upgrade is necessary to address a unique issue.
Web Camera	64K bit	No	Yes	Store Web Cam configuration and firmware.	Using a utility from the device manufacturer that can be run from Windows.	A utility is required for writing data to this memory and is typically not made available to the public unless a firmware upgrade is necessary to address a unique issue.
Fingerprint Reader	512kByte Flash	Yes	Yes	Stores fingerprint templates.	By enrolling in HP ProtectTools Security Manager.	Only a digitally signed application can make the call to write to the flash.



## Questions and answers

**1. How can the BIOS settings be restored (returned to factory settings)?**

- a. Turn on or restart the computer and press **F10** when prompted near the bottom of the display.
- b. Select **Main**, then select **Restore defaults**.
- c. Follow the on-screen instructions.
- d. Select **Main**, save changes and exit, then press **Enter**.

**2. What kind of configuration data is stored on the DIMM Serial Presence Detect (SPD) memory module? How would this data be written?**

The DIMM SPD memory contains information about the memory module such as size, serial number, data width, speed/timing, voltage and thermal information. This information is written by the module manufacturer and stored on an EEPROM. This EEPROM cannot be written to when the memory module is installed in a PC. Third party tools do exist that can write to the EEPROM when the memory module is not installed in a PC. There are various third party tools available to read SPD memory.

**3. Does the “Firmware Hub for System BIOS” contain the BIOS program? Is this chip writable, and if so how?**

The Firmware Hub does contain the BIOS program and is writable. A utility is required to perform the write function.

**4. In some PC systems, the Firmware Hub for System BIOS is a flash memory chip so that updates can be written by the customer. Is this true for these BIOS chips?**

Yes, they are flash memory chips.

**5. What is meant by “Restore the nonvolatile memory found in Intel-based system boards”?**

This relates to clearing the Real Time Clock (RTC) CMOS memory that contains PC configuration data.

**6. Does resetting the CMOS configuration memory return the PC back to factory defaults?**

The process of resetting the CMOS will return certain system settings to factory default but will not reset many of the system data and configuration defaults to their factory settings. To return these system data and configuration defaults to factory settings, refer to question and answer 1 and follow the instructions for returning the BIOS settings to factory defaults.

## Using HP Sure Start (select models only)

Select computer models are configured with HP Sure Start, a technology that continuously monitors your computer's BIOS for attacks or corruption. If the BIOS becomes corrupted or is attacked, HP Sure Start restores the BIOS to its previously safe state automatically, without user intervention. Those select computer models ship with HP Sure Start configured and enabled. Most users can use HP Sure Start with the default configuration.

To access the latest documentation on HP Sure Start, go to <http://www.hp.com/support>, and select your country. Select **Drivers & Downloads**, and then follow the on-screen instructions.

---

# 15 Power cord set requirements

The wide-range input feature of the computer permits it to operate from any line voltage from 100 to 120 V ac, or from 220 to 240 V ac.

The 3-conductor power cord set included with the computer meets the requirements for use in the country or region where the equipment is purchased.

Power cord sets for use in other countries or regions must meet the requirements of the country and region where the computer is used.

## Requirements for all countries

The following requirements are applicable to all countries and regions:

- The length of the power cord set must be at least **1.0 m** (3.3 ft) and no more than **2.0 m** (6.5 ft).
- All power cord sets must be approved by an acceptable accredited agency responsible for evaluation in the country or region where the power cord set will be used.
- The power cord sets must have a minimum current capacity of 10 A and a nominal voltage rating of 125 or 250 V ac, as required by the power system of each country or region.
- The appliance coupler must meet the mechanical configuration of an EN 60 320/IEC 320 Standard Sheet C13 connector for mating with the appliance inlet on the back of the computer.

## Requirements for specific countries and regions

Country/region	Accredited agency	Applicable note number
Argentina	IRAM	1
Australia	SAA	1
Austria	OVE	1
Belgium	CEBEC	1
Brazil	ABNT	1
Canada	CSA	2
Chile	IMQ	1
Denmark	DEMKO	1
Finland	FIMKO	1
France	UTE	1
Germany	VDE	1
India	ISI	1
Israel	SII	1
Italy	IMQ	1
Japan	JIS	3
The Netherlands	KEMA	1
New Zealand	SANZ	1
Norway	NEMKO	1
The People's Republic of China	CCC	4
Saudi Arabia	SASO	7
Singapore	PSB	1
South Africa	SABS	1
South Korea	KTL	5
Sweden	SEMKO	1
Switzerland	SEV	1
Taiwan	BSMI	6
Thailand	TISI	1
The United Kingdom	ASTA	1

Country/region	Accredited agency	Applicable note number
The United States	UL	2
<ol style="list-style-type: none"> <li>1. The flexible cord must be Type H05VV-F, 3-conductor, 0.75 mm<sup>2</sup> conductor size. Power cord set fittings (appliance coupler and wall plug) must bear the certification mark of the agency responsible for evaluation in the country or region where it will be used.</li> <li>2. The flexible cord must be Type SVT/SJT or equivalent, No. 18 AWG, 3-conductor. The wall plug must be a two-pole grounding type with a NEMA 5-15P (15 A, 125 V ac) or NEMA 6-15P (15 A, 250 V ac) configuration. CSA or C-UL mark. UL file number must be on each element.</li> <li>3. The appliance coupler, flexible cord, and wall plug must bear a “T” mark and registration number in accordance with the Japanese Dentori Law. The flexible cord must be Type VCTF, 3-conductor, 0.75 mm<sup>2</sup> or 1.25 mm<sup>2</sup> conductor size. The wall plug must be a two-pole grounding type with a Japanese Industrial Standard C8303 (7 A, 125 V ac) configuration.</li> <li>4. The flexible cord must be Type RVV, 3-conductor, 0.75 mm<sup>2</sup> conductor size. Power cord set fittings (appliance coupler and wall plug) must bear the CCC certification mark.</li> <li>5. The flexible cord must be Type H05VV-F 3-conductor, 0.75 mm<sup>2</sup> conductor size. KTL logo and individual approval number must be on each element. Corset approval number and logo must be printed on a flag label.</li> <li>6. The flexible cord must be Type HVCTF 3-conductor, 1.25 mm<sup>2</sup> conductor size. Power cord set fittings (appliance coupler, cable, and wall plug) must bear the BSMI certification mark.</li> <li>7. For 127 V ac, the flexible cord must be Type SVT or SJT 3-conductor, 18 AWG, with plug NEMA 5-15P (15 A, 125 V ac), with UL and CSA or C-UL marks. For 240 V ac, the flexible cord must be Type H05VV-F 3-conductor, 0.75 mm<sup>2</sup> or 1.00 mm<sup>2</sup> conductor size, with plug BS 1363/A with BSI or ASTA marks.</li> </ol>		



---

## 16 Recycling

When a non-rechargeable or rechargeable battery has reached the end of its useful life, do not dispose of the battery in general household waste. Follow the local laws and regulations in your area for battery disposal.

HP encourages customers to recycle used electronic hardware, HP original print cartridges, and rechargeable batteries. For more information about recycling programs, see the HP Web site at <http://www.hp.com/recycle>.





# Index

## A

- AC adapter, spare part numbers 32, 34, 35
- AC adapter/battery light 14
- accessory battery connector, identifying 17
- antenna
  - removal 97
  - spare part numbers 26, 28, 38, 92
- audio, product description 2
- audio-in (microphone) jack, identifying 16
- audio-out (headphone) jack, identifying 16

## B

- backing up Ubuntu data files 132
- backup
  - Ubuntu 129
  - Windows 8.1 119
- Backup and Restore 125
- backup tools, Windows 7 123
- backups for Windows 7
  - recovering 125
- backups for Windows 7, creating 124
- base enclosure, internal
  - spare part numbers 25, 38, 71
- base enclosure, internal for 14 in models
  - removal 68
  - spare part numbers 68
- base enclosure, internal for 15 in models
  - removal 71
- battery
  - removal 49
  - spare part numbers 23, 34, 49

## BIOS

- determining version 101, 109
  - downloading an update 101
  - downloading an update in
    - Windows 7 109
    - Ubuntu 115
  - updating 100, 108
- Blu-ray ROM DVD±RW SuperMulti DL Drive
- precautions 42
- broadband module
- spare part numbers 25, 34, 35, 54
- buttons
- left pointing stick 8
  - left TouchPad 8
  - power 11
  - right pointing stick 9
  - right TouchPad 9

## C

- cables, service considerations 41
- caps lock light, identifying 10
- card reader board
  - removal 75
  - spare part number 23, 35, 75
- components
  - bottom 17
  - display 7
  - front 14
  - left side 15
  - right side 16
  - top 8
- computer major components 22
- Computer Setup
  - navigating and selecting 99, 107
  - restoring factory settings 100, 108

- computer specifications 135, 136
- connector, power 16
- connectors, service considerations 41
- creating a restore image for
  - Ubuntu 129
- creating a restore image on a USB device for Ubuntu 130
- creating a restore image on DVD for Ubuntu 129

## D

- default settings, restoring in
  - Ubuntu 116
- display
  - specifications 138, 139, 140, 141, 142
- display assembly
  - removal 92
  - spare part numbers 23, 36
  - subcomponents 26
- display assembly, spare part numbers 92
- display bezel
  - spare part numbers 26, 28, 35, 36, 63
- display enclosure, spare part numbers 27, 29, 38, 92
- display hinge
  - removal 96, 97
  - spare part numbers 27, 28, 34
- Display Hinge Kit, spare part numbers 27, 28, 34
- display hinges, spare part numbers 92
- display panel
  - product description 1
  - removal 63
  - spare part numbers 26, 28, 63

- display panel cable
  - spare part numbers 26, 28, 34
- DisplayPort, identifying 16
- docking connector, identifying 16
- Driver Recovery DVD for Windows 7,
  - creating 124
  - using for restore 127
- drives, preventing damage 42
- DVD-ROM Drive
  - precautions 42
- DVD±RW Double-Layer with SuperMulti Drive
  - precautions 42

## E

- electrostatic discharge 42
- embedded numeric keypad,
  - identifying 13
- equipment guidelines 45
- esc key, identifying 13
- Ethernet, product description 2
- external monitor port 15

## F

- f11 recovery for Windows 7 127
- f11 recovery, Windows 8.1 120
- factory settings, restoring in
  - Ubuntu 116
- fan
  - removal 74
  - spare part number 23, 34, 74
- fingerprint reader assembly
  - removal 83
  - spare part number 34, 83
- fingerprint reader board
  - spare part number 23
- fingerprint reader insert,
  - illustrated 31
- fingerprint reader, identifying 12
- fn key, identifying 13
- function keys, identifying 13
- Fusion Controller Hub, product
  - description 1

## G

- graphics, product description 1
- grounding guidelines 42
- guidelines
  - equipment 45
  - grounding 42
  - packaging 44

- transporting 44
- workstation 44

## H

- hard drive
  - precautions 42
  - product description 2
  - removal 50
  - spare part numbers 23, 30, 33, 34, 35, 50
  - specifications 143
- hard drive bracket
  - removal 51
- Hard Drive Hardware Kit
  - contents 30
  - spare part number 24, 30, 34, 50
- hard drive light 14
- hard drive recovery for Windows 7 127
- hard drive recovery, Windows 8.1 120
- headphone (audio-out) jack 16
- heat sink
  - removal 79
  - spare part numbers 24, 35, 79
- HP Recovery Disc Creator, using
  - Windows 7 124
- HP Recovery partition, Windows 7
  - checking for presence 127
  - using for recovery 127
- HP Sure Start 150

## I

- integrated webcam light,
  - identifying 7
- internal base enclosure
  - spare part numbers 25, 38, 68, 71
- internal base enclosure, 14 in models
  - removal 68
- internal base enclosure, 15 in models
  - removal 71
- internal display switch 8
- internal microphones, identifying 7

## J

- jacks
  - audio-in (microphone) 16
  - audio-out (headphone) 16

- network 16
- RJ-45 (network) 16

## K

- key
  - Windows key 13
- keyboard
  - product description 4
  - removal 58
  - spare part numbers 23, 36, 37, 38, 58
- keypad
  - embedded numeric 13
- keys
  - esc 13
  - fn 13
  - function 13

## L

- latches, service door release 17, 19
- legacy support, USB 99, 107
- lights
  - AC adapter/battery 14
  - caps lock 10
  - hard drive 14
  - power 10, 14
  - webcam 7
  - wireless 10, 14

## M

- mass storage device
  - illustrated 30
  - precautions 42
  - spare part numbers 30
- memory
  - nonvolatile 145
  - volatile 145
- memory card reader, identifying 16
- memory module
  - product description 2
  - removal 52
  - spare part numbers 24, 34, 52
- microphone
  - product description 2
- microphone (audio-in) jack,
  - identifying 16
- microphone module
  - spare part numbers 26, 28, 34, 64
- model name 1

- MultiBoot
  - Windows 7 110
- N**
  - network jack, identifying 16
  - nonvolatile memory 145
- O**
  - operating system, product
    - description 4
  - optical drive
    - precautions 42
- P**
  - packaging guidelines 44
  - plastic parts, service
    - considerations 41
  - Plastics Kit
    - contents 31
    - spare part numbers 31, 34
  - pointing device, product
    - description 4
  - pointing stick 8
  - ports
    - DisplayPort 16
    - external monitor 15
    - product description 4
  - power button board
    - removal 81
    - spare part number 23, 34, 81
  - power button, identifying 11
  - power connector, identifying 16
  - power cord
    - requirements for all countries 151
    - requirements for specific
      - countries and regions 152
    - set requirements 151
    - spare part numbers 32, 33
  - power cord, spare part numbers 32, 35
  - power lights 10, 14
  - power requirements, product
    - description 4
  - processor
    - product description 1
  - product description
    - audio 2
    - display panel 1
    - Ethernet 2
    - external media cards 3
  - Fusion Controller Hub 1
    - graphics 1
    - hard drive 2
    - keyboard 4
    - memory module 2
    - microphone 2
    - operating system 4
    - pointing device 4
    - ports 4
    - power requirements 4
    - processors 1
    - product name 1
    - security 4
    - serviceability 6
    - solid-state drive 2
    - video 2
    - wireless 3
  - product name 1, 20
- R**
  - recovery media, creating for Windows
    - 7 124
  - recovery media, using for restore on
    - Windows 7 127
  - recovery partition for Windows 7
    - 127
  - recovery partition, Windows 8.1
    - 120
  - recovery tools, Windows 7 123, 125
  - recovery, Windows 7 system 125
  - recovery, Windows 8.1 122
  - refresh, Windows 8.1 122
  - removal/replacement
    - preliminaries 41
    - procedures 47, 63
  - removing personal data from volatile
    - system memory 145
  - restoring the hard drive for Windows
    - 7 127
  - restoring the hard drive, Windows
    - 8.1 120
  - restoring Ubuntu data files 133
  - RJ-45 (network) jack, identifying 16
  - RJ-45 door, illustrated 31
  - RJ-45 flat spring, illustrated 31
  - RTC battery
    - removal 67
    - spare part number 23, 33, 67
  - Rubber Kit, spare part numbers 25, 34
- S**
  - Screw Kit, spare part numbers 34
  - SD card insert 31
  - security cable slot, identifying 15
  - security, product description 4
  - serial number 20
  - service considerations
    - cables 41
    - connectors 41
    - plastic parts 41
  - service door
    - identifying 17, 19
    - removal 47
    - spare part number 35
    - spare part numbers 25, 36, 47
  - service door release latch 17, 19
  - service label 20
  - service tag 20
  - serviceability, product description 6
  - Setup Utility
    - displaying system information
      - 116
    - exiting in Ubuntu 116
    - navigating 115
    - restoring default settings in
      - Ubuntu 116
    - selecting 115
  - setup utility
    - navigating and selecting 99, 107
    - restoring factory settings 100, 108
  - Setup Utility in Ubuntu
    - changing the language 115
    - starting 115
  - SIM slot, identifying 18, 19
  - slots
    - security cable 15
    - smart card 15
  - smart card slot 15
  - solid-state drive
    - precautions 42
    - product description 2
    - spare part numbers 24, 30, 35
    - specifications 144
  - speaker assembly
    - removal 90
    - spare part number 23, 34, 90
  - speakers, identifying 11

- specifications
  - computer 135, 136
  - display 138, 139, 140, 141, 142
  - hard drive 143
  - solid-state drive 144
- SSD
  - spare part numbers 24, 30, 35
  - specifications 144
- Startup Repair, using Windows 7 125
- system board
  - removal 85
  - spare part numbers 24, 25, 38, 39, 85
- system information, displaying 116
- system memory, removing personal data from volatile 145

## T

- tools required 41
- top cover, spare part numbers 23, 38
- TouchPad
  - buttons 8, 9
- TouchPad zone
  - identifying 8
- transporting guidelines 44

## U

- UEFI
  - Windows 7 112, 116
- USB 3.0 port 15, 16
- USB legacy support 99, 107
- USB ports, identifying 15, 16

## V

- vents, identifying 15, 18, 19
- VGA/USB board
  - removal 77
  - spare part number 23, 35, 36, 77
- video, product description 2

## W

- warranty period 20
- webcam 8
- webcam light, identifying 7
- webcam module
  - removal 66
  - spare part numbers 26, 28, 38, 64

- webcam, identifying 8
- webcam/microphone module
  - removal 95
- Windows 7 operating system DVD
  - creating 124
  - using for restore 127
- Windows 7 operating system media
  - creating 124
  - using for restore 127
- Windows 8.1
  - Refresh 122
- Windows 8.1 operating system DVD 121
- Windows key, identifying 13
- Windows Startup Repair, using Windows 7 125
- wireless antenna
  - removal 97
  - spare part numbers 26, 28, 92
- Wireless Antenna Kit, spare part numbers 92
- wireless antennas, identifying 7
- wireless light 10, 14
- wireless, product description 3
- WLAN
  - spare part numbers 34
- WLAN antennas, identifying 7
- WLAN module
  - removal 56
  - spare part numbers 25, 34, 56
- workstation guidelines 44
- WWAN antennas, identifying 7
- WWAN module
  - removal 54
  - spare part numbers 25, 34, 35, 54

## Free Manuals Download Website

<http://myh66.com>

<http://usermanuals.us>

<http://www.somanuals.com>

<http://www.4manuals.cc>

<http://www.manual-lib.com>

<http://www.404manual.com>

<http://www.luxmanual.com>

<http://aubethermostatmanual.com>

Golf course search by state

<http://golfingnear.com>

Email search by domain

<http://emailbydomain.com>

Auto manuals search

<http://auto.somanuals.com>

TV manuals search

<http://tv.somanuals.com>