



HP EliteBook 740 G1 Notebook PC
HP EliteBook 840 G1 Notebook PC
HP ZBook 14 Mobile Workstation
HP EliteBook 750 G1 Notebook PC
HP EliteBook 850 G1 Notebook PC

Maintenance and Service Guide

© Copyright 2013—2015 Hewlett-Packard Development Company, L.P.

Bluetooth is a trademark owned by its proprietor and used by Hewlett-Packard Company under license. Intel and Core are U.S. registered trademarks of Intel Corporation. Microsoft, Windows, and Windows Vista are U.S. registered trademarks of Microsoft Corporation. SD Logo is a trademark of its proprietor.

The information contained herein is subject to change without notice. The only warranties for HP products and services are set forth in the express warranty statements accompanying such products and services. Nothing herein should be construed as constituting an additional warranty. HP shall not be liable for technical or editorial errors or omissions contained herein.

Third Edition: April 2015

Second Edition: November 2014

First Edition: September 2013

Document Part Number: 734761-003

Important Notice about Customer Self-Repair Parts

 **CAUTION:** Your computer includes Customer Self-Repair parts and parts that should only be accessed by an authorized service provider. See Chapter 5, "Removal and replacement procedures for Customer Self-Repair parts," for details. Accessing parts described in Chapter 6, "Removal and replacement procedures for Authorized Service Provider only parts," can damage the computer or void your warranty.

Safety warning notice

 **WARNING!** To reduce the possibility of heat-related injuries or of overheating the device, do not place the device directly on your lap or obstruct the device air vents. Use the device only on a hard, flat surface. Do not allow another hard surface, such as an adjoining optional printer, or a soft surface, such as pillows or rugs or clothing, to block airflow. Also, do not allow the AC adapter to contact the skin or a soft surface, such as pillows or rugs or clothing, during operation. The device and the AC adapter comply with the user-accessible surface temperature limits defined by the International Standard for Safety of Information Technology Equipment (IEC 60950).

Table of contents

1 Product description	1
2 External component identification	8
Display	8
Top	9
TouchPad	9
Lights	10
Buttons and fingerprint reader (select models only)	11
Keys	12
Front	13
Left	15
Right	16
Bottom	17
Service tag	19
3 Illustrated parts catalog	20
Computer major components	20
Display assembly subcomponents	31
HP EliteBook 740/840/ZBook 14 models	31
HP EliteBook 750/850 models	32
Mass storage devices	33
Plastics Kit	35
Miscellaneous parts	36
Sequential part number listing	38
4 Removal and replacement procedures preliminary requirements	53
Tools required	53
Service considerations	53
Plastic parts	53
Cables and connectors	53
Drive handling	54
Grounding guidelines	54
Electrostatic discharge damage	54
Packaging and transporting guidelines	55
Workstation guidelines	55

5 Removal and replacement procedures for Customer Self-Repair parts	57
Component replacement procedures	57
Service cover	57
Battery	59
Hard drive	60
Solid-state drive (SSD)	62
RTC battery	64
Memory module	65
WWAN module	67
WLAN module	69
Keyboard	71
6 Removal and replacement procedures for Authorized Service Provider parts	75
Component replacement procedures	75
Display panel (non-touch)	75
Base enclosure	79
Base enclosure (HP EliteBook 840/HP ZBook14 models)	79
Base enclosure (HP EliteBook 850 models)	82
Fan	85
Card reader board	86
VGA/USB board	87
Heat sink	88
Power button board	92
Fingerprint reader assembly	94
System board	96
Speaker assembly	106
Display assembly	108
7 Computer Setup (BIOS), MultiBoot, and System Diagnostics in Windows 8	115
Using Computer Setup	115
Starting Computer Setup	115
Navigating and selecting in Computer Setup	115
Restoring factory settings in Computer Setup	116
Updating the BIOS	116
Determining the BIOS version	116
Downloading a BIOS update	117
HP Sure Start	117
Using MultiBoot	118
About the boot device order	118
Choosing MultiBoot preferences	118

Setting a new boot order in Computer Setup	118
Dynamically choosing a boot device using the f9 prompt	119
Setting a MultiBoot Express prompt	119
Entering MultiBoot Express preferences	119
Using HP PC Hardware Diagnostics (UEFI) (select models only)	120
Downloading HP PC Hardware Diagnostics (UEFI) to a USB device	120
8 Computer Setup (BIOS) and HP PC Hardware Diagnostics (UEFI) in Windows 7	121
Using Computer Setup	121
Starting Computer Setup	121
Navigating and selecting in Computer Setup	121
Restoring factory settings in Computer Setup	122
Updating the BIOS	122
Determining the BIOS version	122
Downloading a BIOS update	123
HP Sure Start	123
Using MultiBoot	124
About the boot device order	124
Choosing MultiBoot preferences	124
Setting a new boot order in Computer Setup	124
Dynamically choosing a boot device using the f9 prompt	125
Setting a MultiBoot Express prompt	125
Entering MultiBoot Express preferences	125
Using HP PC Hardware Diagnostics (UEFI) (select models only)	126
Downloading HP PC Hardware Diagnostics (UEFI) to a USB device	126
9 Computer Setup (BIOS) and Advanced System Diagnostics in SUSE Linux	127
Starting Computer Setup	127
Using Computer Setup	127
Navigating and selecting in Computer Setup	127
Restoring factory settings in Computer Setup	129
Updating the BIOS	129
Determining the BIOS version	129
Downloading a BIOS update	130
HP Sure Start	130
Using MultiBoot	131
About the boot device order	131
Choosing MultiBoot preferences	131
Dynamically choosing a boot device using the f9 prompt	131
Using HP PC Hardware Diagnostics (UEFI) (select models only)	131
Downloading HP PC Hardware Diagnostics (UEFI) to a USB device	132

10 Backup and recovery in Windows 8	133
Backing up your information	133
Performing a system recovery	134
Using the Windows recovery tools	134
Using f11 recovery tools	135
Using Windows 8 operating system media (purchased separately)	135
Using Windows Refresh for quick and easy recovery	136
Remove everything and reinstall Windows	136
Using HP Software Setup	137
11 Backup and recovery in Windows 7	138
Creating recovery media and backups	138
Guidelines	138
Creating recovery media with HP Recovery Disc Creator	138
Creating recovery media	139
Backing up your information	139
Performing a system recovery	140
Using the Windows recovery tools	140
Using f11 recovery tools (select models only)	142
Using Windows 7 operating system media	142
12 Backup and Recovery in SUSE Linux	144
Creating backups	144
Backing up your information	144
Performing a system recovery	145
Remove everything and reinstall SLED	145
13 Specifications	147
Computer specifications—HP EliteBook 840/HP ZBook 14 models	147
Computer specifications—HP EliteBook 850 models	148
35.6-cm (14.0-in) HD SVA display specifications	148
35.6-cm (14.0-in) HD+ SVA display specifications	149
35.6-cm (14.0-in) HD+ SVA display specifications	150
39.6-cm (15.6-in) HD SVA display specifications	150
39.6-cm (15.6-in) FHD SVA display specifications	151
Hard drive specifications	151
Solid-state drive specifications	152

14 Statement of Volatility	153
HP Sure Start	154
Non-volatile memory usage	155
Questions and answers	156
15 Power cord set requirements	158
Requirements for all countries	158
Requirements for specific countries and regions	158
16 Recycling	160
Index	161

1 Product description

Category	Description	HP EliteBook 740/840	HP ZBook 14	HP EliteBook 750/850
	HP EliteBook 740 G1 Notebook PC	√		
Product Name	HP EliteBook 840 G1 Notebook PC	√		
	HP ZBook 14 Mobile Workstation		√	
	HP EliteBook 750 G1 Notebook PC			√
	HP EliteBook 850 G1 Notebook PC			√
Processors	Offers the following processors:	√	√	√
	<ul style="list-style-type: none"> Intel® Dual Core® i7-4600U 2.10-GHz processor (SC turbo up to 3.30-GHz; 4.0-MB L3 cache, 15 W) Intel Dual Core® i7-4510U 2.00-GHz processor (SC turbo up to 3.10-GHz; 4.0-MB L3 cache, 15 W) Intel Dual Core® i7-4500U 1.80-GHz processor (SC turbo up to 3.00-GHz; 4.0-MB L3 cache, 15 W) Intel Dual Core i5-4310U 2.00-GHz processor (SC turbo up to 3.00-GHz; 3.0-MB L3 cache, 15 W) Intel Dual Core i5-4300U 1.90-GHz processor (SC turbo up to 2.90-GHz; 3.0-MB L3 cache, 15 W) Intel Dual Core i5-4210U 1.70-GHz processor (SC turbo up to 2.70-GHz; 3.0-MB L3 cache, 15 W) Intel Dual Core i5-4200U 1.60-GHz processor (SC turbo up to 2.60-GHz; 3.0-MB L3 cache, 15 W) 			
	Intel Dual Core i3-4030U 1.90-GHz processor; 3.0-MB L3 cache, 15 W)	√		√
	Intel Dual Core i3-4010U 1.70-GHz processor; 3.0-MB L3 cache, 15 W)			
Chipset	Mobile Intel QM87 chipset	√	√	√
Graphics	Switchable discrete graphics: AMD Radeon™ HD 8750M, with support for up to 5 displays through the APR	√		√
	Internal graphics: <ul style="list-style-type: none"> Universal memory architecture (UMA) with shared video memory with support for up to 3 displays through the APR Intel HD Graphics 4400 Support dual-display ports through the dock Supports hybrid (switchable) graphics			
	Switchable discrete graphics: AMD FirePro M4100, with support for up to 5 displays through the APR Support dual-display ports through the dock		√	

Category	Description	HP EliteBook 740/840	HP ZBook 14	HP EliteBook 750/850
	Supports hybrid (switchable) graphics			
Panel	<p>All display assemblies include two or three wireless local area network (WLAN) antenna cables and two wireless wide area network (WWAN) antenna cables</p> <p>(35.6-cm) 14.0-in LED, HD, AntiGlare (AG), SVA (1366×768), 200 nits display with and without webcam</p> <p>(35.6-cm) 14.0-in LED, HD+, AG, SVA (1920×1080), 250 nits display with and without webcam</p> <p>(35.6-cm) 14.0-in LED, HD+, AG, SVA (1920×1080) 250 nits capacitive touch display with webcam</p> <p>(35.6-cm) 14.0-in LED, FHD, AG, SVA (1920×1080) 300 nits display with and without webcam</p>	√	√	
	<ul style="list-style-type: none"> • (39.6-cm) 15.6-in LED, FHD, AG, SVA (1920×1080) 200 nits display with and without webcam • (39.6-cm) 15.6-in LED, HD, AG, SVA (1368×768) 300 nits display with and without webcam 			√
Memory	<p>Two customer-accessible/upgradable memory module slots with the following specifications:</p> <p>DDR3L-1600-MHz dual channel support</p> <p>Supports 16384-MB of system RAM in the following configurations:</p> <ul style="list-style-type: none"> • 16384-MB (8192-MB×2) • 12288-MB (8192-MB+4096-MB) • 8192-MB (8192-MB×1 or 4096×2) • 8192-MB (8192-MB×1 or 4096×2; not supported on computer models equipped with a 32-bit operating system) • 6144-MB (4096-MB+2048-MB) • 4096-MB (4096-MB×1 or 2048-MB×2) • 2048-MB (2048×1) 	√		√
	<p>Two customer-accessible/upgradable memory module slots with the following specifications:</p> <p>DDR3L-1600-MHz dual channel support</p> <p>Supports 16384-MB of system RAM in the following configurations:</p> <ul style="list-style-type: none"> • 16384-MB (8192-MB×2) • 8192-MB (8192-MB×1 or 4096×2) • 8192-MB (8192-MB×1 or 4096×2; not supported on computer models equipped with a 32-bit operating system) • 4096-MB (4096-MB×1 or 2048-MB×2) 		√	

Category	Description	HP EliteBook 740/840	HP ZBook 14	HP EliteBook 750/850
Primary storage	Supports 6.35-cm (2.5-in) hard drives in 9.5-mm (.37-in) and 7.0-mm (.28-in) thicknesses (all hard drives use the same bracket)	✓	✓	✓
	Customer-accessible			
	Supports the following hard drives: <ul style="list-style-type: none"> 1-TB, 5400-rpm 500-GB, 7200-rpm, self-encrypting drive (SED) 500-GB, 7200-rpm 500-GB, 5400-rpm, self-encrypting drive (SED, FIPS-140-2) 500-GB, 5400-rpm 320-GB, 7200-rpm 320-GB, 5400-rpm Supports the following SSDs: <ul style="list-style-type: none"> 256-GB SATA III, SED 240-GB, SATA III 180-GB, SATA III 128-GB 	✓		✓
	Supports the following hard drives: <ul style="list-style-type: none"> 1-TB, 5400-rpm 750-GB, 7200-rpm 500-GB, 7200-rpm, self-encrypting drive (SED) 500-GB, 7200-rpm 500-GB, 5400-rpm, self-encrypting drive (SED, FIPS-140-2) 320-GB, 7200-rpm Supports the following SSDs: <ul style="list-style-type: none"> 512-GB 256-GB SATA III, SED 240-GB, SATA III 180-GB, SATA III 128-GB 		✓	
Flash cache	M.2 (NGFF) module	✓	✓	✓
	Intel SRT (Smart Response Technology)	✓	✓	✓
	32 GB	✓	✓	✓
	Supports "No Flash Cache" option	✓	✓	✓
	Not available with SSD or SED HDD	✓	✓	✓

Category	Description	HP EliteBook 740/840	HP ZBook 14	HP EliteBook 750/850
Mini-card SSD	M.2 (NGFF) Solid State Drive		✓	
	120 GB		✓	
	Not available if 32-GB flash cache is selected		✓	
Audio and video	Two stereo speakers	✓	✓	✓
	HD audio with DTS Sound Studio	✓	✓	✓
	Integrated 720p HD webcam (supports no camera option)	✓	✓	✓
	Integrated dual-array microphone	✓	✓	✓
Ethernet	Intel® I218LM Gigabit Network Connection	✓	✓	✓
	S3/S4/S5 wake on LAN			
Wireless	Integrated wireless local area network (WLAN) options by way of minicard	✓	✓	✓
	Two WLAN antennas built into display assembly			
	Support for the following WLAN formats:			
	<ul style="list-style-type: none"> Atheros WB225 1×1 802.11b/g/n Bluetooth Combo Adapter 			
	<ul style="list-style-type: none"> Broadcom 43228 802.11 abgn 2×2 Wi-Fi Adapter 			
	<ul style="list-style-type: none"> Intel Centrino Advanced-N 6205 WLAN module 			
	<ul style="list-style-type: none"> Intel Centrino Ultimate-N 6300 WLAN module 			
	<ul style="list-style-type: none"> Intel Centrino Wireless-N 2200 802.11b/g/n 2×2 WiFi Adaptor 			
	Supports no WLAN option			
	Integrated wireless wide area network (WWAN) options by way of wireless module	✓	✓	✓
Two world-wide/5-band WWAN antennas built into display assembly				
Secured by subscriber identity module (SIM, user-accessible behind battery)				
Support for the following WWAN formats:				
<ul style="list-style-type: none"> HP lt4111 LTE/EV-DO/HSPA+ Mobile Broadband Module 				
<ul style="list-style-type: none"> HP lt4112 LTE/HSPA+ Mobile Broadband Module 				
<ul style="list-style-type: none"> HP hs3110 HSPA+ Mobile Broadband Module 				
Supports no WWAN option				
Supports WWAN after market option				
External media cards	Media reader slot supporting the following digital card formats:	✓	✓	✓
	<ul style="list-style-type: none"> Secure Digital (SD) Memory Card 			
	<ul style="list-style-type: none"> SDHC SDXC 			
Ports	Offers the following ports:	✓	✓	✓

Category	Description	HP EliteBook 740/840	HP ZBook 14	HP EliteBook 750/850
	<ul style="list-style-type: none"> Headphone/microphone combo Battery connector DisplayPort 1.2 Docking connector USB 3.0 ports (3) USB 3.0 charging port HP Smart AC adapter RJ-45 (Ethernet) Secondary battery connector VGA (Dsub 15 pin) supporting: 1920×1200 external resolution @ 75 Hz, hot plug and unplug and autodetection for correct output to wide-aspect vs. standard aspect video 			
Keyboard/pointing devices	Glass with chemical etched surface, dual-point, spill-resistant with drain, DuraKeys	√	√	√
	Gesture support: MultiTouch gestures enabled, two-finger scrolling, and pinch-zoom as default	√	√	√
	Taps enabled by default	√	√	√
	Supports two-way scroll	√	√	√
	On/off button	√	√	√
Power requirements	Supports the following HP Smart AC adapters:			
	<ul style="list-style-type: none"> 65-W HP Smart AC adapter 	√	√	√
	<ul style="list-style-type: none"> 65-W HP Slim Smart AC adapter 	√	√	√
	<ul style="list-style-type: none"> 45-W HP Smart AC adapter 	√		√
	Supports the following batteries:	√	√	√
	<ul style="list-style-type: none"> 3-cell, 50-Wh, 4.45-Ah long-life battery 3-cell, 24-Wh, 2.2-Ah long-life battery Secondary 6-cell, 60-Wh, 2.7-Ah battery 			
	<ul style="list-style-type: none"> Secondary 6-cell, 60-Wh, 2.7-Ah battery 	√	√	
Security	Supports security cable lock	√	√	√
	Supports fingerprint reader and no fingerprint reader option	√	√	√
	Supports Trusted Platform Module (TPM) 1.2 (Infineon, soldered down) and TPM Enhanced Drive Lock	√	√	√
	Integrated Smart Card reader (active)	√	√	√
	Full volume encryption	√	√	√
	Preboot authentication (password, Smart Card)	√	√	√
Operating system	Windows 7, Service Pack 1	√	√	√

Category	Description	HP EliteBook 740/840	HP ZBook 14	HP EliteBook 750/850
	Windows 8 Multi-Language 64	√	√	√
	Windows 8 Professional 64	√	√	√
	Windows 8 License with Win 7 Downgrade	√	√	√
	Preinstalled:	√	√	√
	<ul style="list-style-type: none"> Windows® 8 ML 64 Windows 8 CH Windows 8 EM Windows 8 Professional 64 Windows 8 Professional 64 DPK with Windows 7 Professional 64 and 32 Windows 7 Home Premium 64 and 32 (not available with HP ZBook 14) Windows 7 Professional 64 and 32 FreeDOS SUSE Linux (SLED 11) SP2, 64-bit 			
	Preinstalled:			√
	<ul style="list-style-type: none"> Windows 8 Professional 64 with MSNA Windows 8 Professional 64 DPK with Windows 7 Professional 64 and 32 with MSNA Windows 7 Professional 64 and 32 with MSNA 			
	Restore media—DR-DVD:	√	√	√
	<ul style="list-style-type: none"> Windows 8 (available with any Windows 8 operating system and required with Windows 8 Professional downgrade operating system) Windows 7 (available with any Windows 7 or Windows 8 downgrade operating system) 			
	Restore media—OS-DVD:	√	√	√
	<ul style="list-style-type: none"> Windows 8 Professional 64-bit (only available and required with Windows 8 Professional downgrade operating system) Windows 8 64-bit Windows 8 Country-Specific 64-bit Windows 8 Emerging Market 64-bit Windows 7 Home Premium 64- and 32-bit (available with any Windows 7 HP operating system except Asia-Pacific countries and regions and the People's Republic of China) Windows 7 Professional 64- and 32-bit (available with any Windows 7 Professional or Windows 8 Professional downgrade except Asia-Pacific countries and regions and the People's Republic of China) 			
	Certified:	√	√	√

Category	Description	HP EliteBook 740/840	HP ZBook 14	HP EliteBook 750/850
	<ul style="list-style-type: none"> • Microsoft WHQL • SuSE Linux Enterprise (SLED) 64-bit Service Pack 2 			
	Web-only support:	√	√	√
	<ul style="list-style-type: none"> • Windows 8.1 Professional 64 • Windows 8.1 Enterprise 64 • Windows 8.1 Multi-Language 64 • Windows 8.1 Emerging Markets 64 • Windows 8.1 Chinese Market 64 • Windows 8 Enterprise 64 • Windows 7 Enterprise 64 and 32 • Windows 7 Ultimate 64 and 32 			
Serviceability	End user replaceable parts:	√	√	√
	<ul style="list-style-type: none"> • AC adapter • Battery • Hard drive/Solid-state drive • Keyboard • Memory module • WLAN module • WWAN module • M.2 (NGFF) Flash cache / SSD 			

2 External component identification

Display

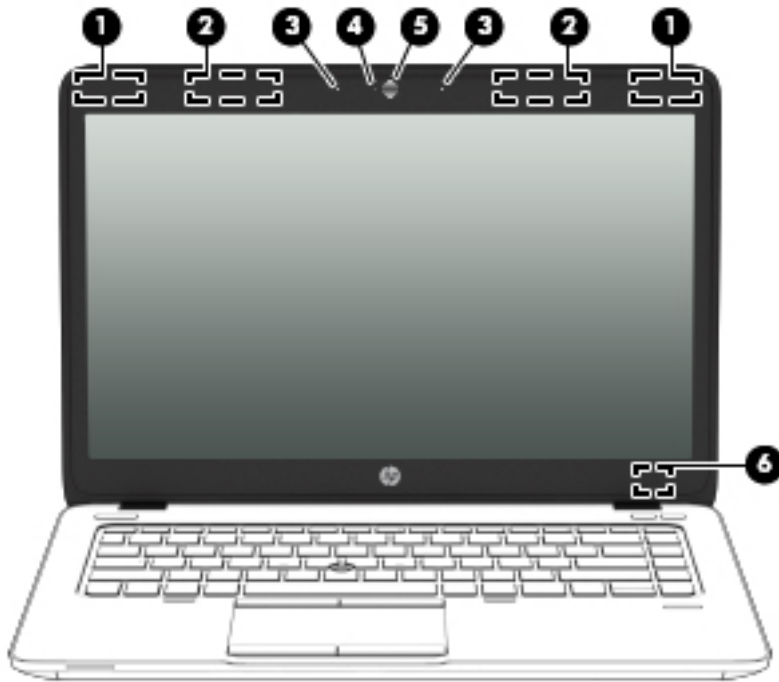

Component	Description
(1) WLAN antennas (2)*	Send and receive wireless signals to communicate with wireless local area networks (WLAN).
(2) WWAN antennas (2)* (select models only)	Send and receive wireless signals to communicate with wireless wide area networks (WWAN).
(3) Internal microphones (2)	Record sound.
(4) Webcam light (select models only)	On: The webcam is in use.
(5) Webcam (select models only)	Records video and captures still photographs. For information on using the webcam, access HP Support Assistant. To access HP Support Assistant in Windows 8, on the Start screen, select the HP Support Assistant app. To access HP Support Assistant in Windows 7, select Start > Help and Support > User Guides .
(6) Internal display switch	Turns off the display or initiates Sleep (Windows)/Suspend (Linux) if the display is closed while the power is on. NOTE: The display switch is not visible on the outside of the computer.

*The antennas are not visible on the outside of the computer. For optimal transmission, keep the areas immediately around the antennas free from obstructions. To see wireless regulatory notices, see the section of the *Regulatory, Safety, and Environmental Notices* that applies to your country or region. To access the user guides in Windows 8, select the **HP Support Assistant** app on the

Component	Description
	Start screen, select My computer , and then select User guides . TO access the user guides in Windows 7, select Start > Help and Support > User Guides .

Top

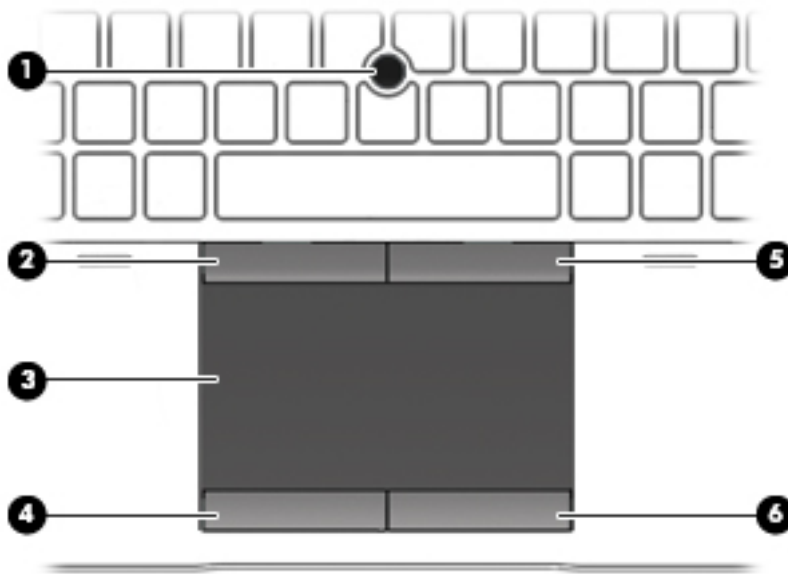

TouchPad

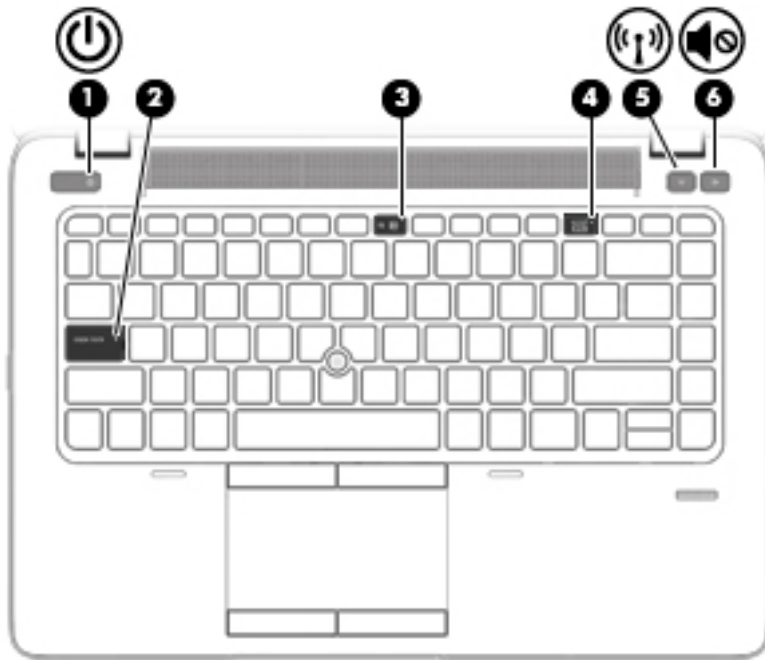

Component		Description
(1)	Pointing stick (select models only)	Moves the pointer and selects or activates items on the screen.
(2)	Left pointing stick button	Functions like the left button on an external mouse.
(3)	TouchPad zone	Moves the pointer and selects or activates items on the screen.
(4)	Left TouchPad button	Functions like the left button on an external mouse.
(5)	Right pointing stick button	Functions like the right button on an external mouse.
(6)	Right TouchPad button	Functions like the right button on an external mouse.

Lights



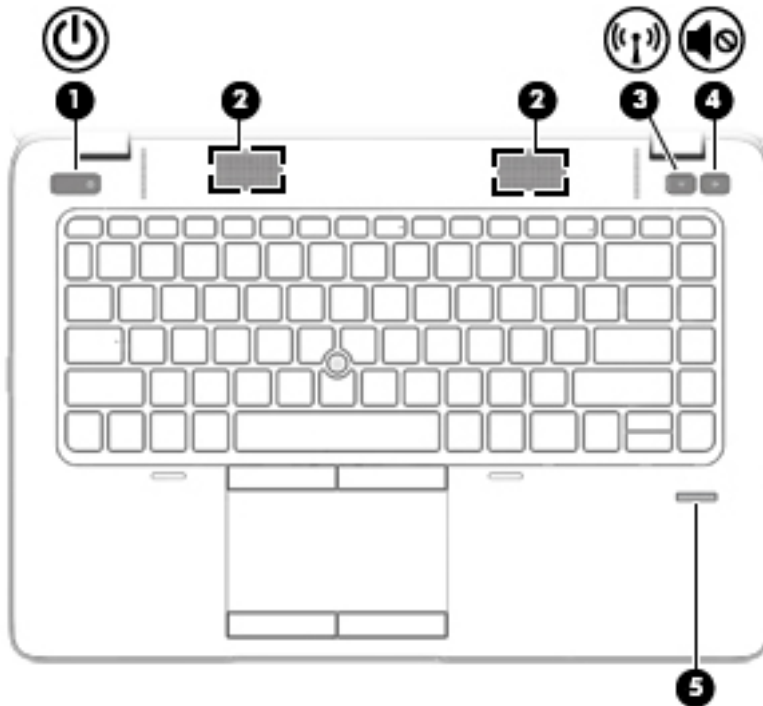

Component	Description
(1)  Power light	<ul style="list-style-type: none"> On: The computer is on. Blinking: The computer is in the Sleep state (Windows) or Suspend state (Linux). Off: The computer is off (Windows) or in Hibernation (Linux).
(2) Caps lock light	On: Caps lock is on.
(3) Microphone mute light	<ul style="list-style-type: none"> Amber: microphone sound is off. Off: microphone sound is on.
(4) Num lock light	On: Num lock is on.
(5)  Wireless light	<ul style="list-style-type: none"> White: An integrated wireless device, such as a wireless local area network (WLAN) device and/or a Bluetooth® device, is on. Amber: All wireless devices are off.
(6)  Mute light	<ul style="list-style-type: none"> Amber: Computer sound is off. Off: Computer sound is on.

Buttons and fingerprint reader (select models only)



Component	Description
(1)  Power button	<ul style="list-style-type: none"> • When the computer is off, press the button to turn on the computer. • When the computer is on, press the button briefly to initiate Sleep. • When the computer is in the Sleep state, press the button briefly to exit Sleep. • When the computer is in Hibernation, press the button briefly to exit Hibernation. <p>CAUTION: Pressing and holding down the power button will result in the loss of unsaved information.</p> <p>If the computer has stopped responding and operating system shutdown procedures are ineffective, press and hold the power button for at least 5 seconds to turn off the computer.</p> <p>To learn more about your power settings:</p> <p>Windows 8:</p> <ul style="list-style-type: none"> ▲ From the Start screen, type <code>power</code>, select Settings, and then select Power Options. <p>Windows 7:</p> <ul style="list-style-type: none"> ▲ Select Start > Control Panel > System and Security > Power Options. <p>Linux:</p> <ol style="list-style-type: none"> 1. Select Computer > Control Center.

Component	Description
	2. In the left pane, click System , and then click Power Management in the right pane.
(2) Speakers (2)	Produce sound.
(3)  Wireless button	Turns the wireless feature on or off but does not establish a wireless connection.
(4)  Volume mute button	Mutes and restores speaker sound.
(5) Fingerprint reader (select models only)	Allows a fingerprint logon to Windows, instead of a password logon.

Keys

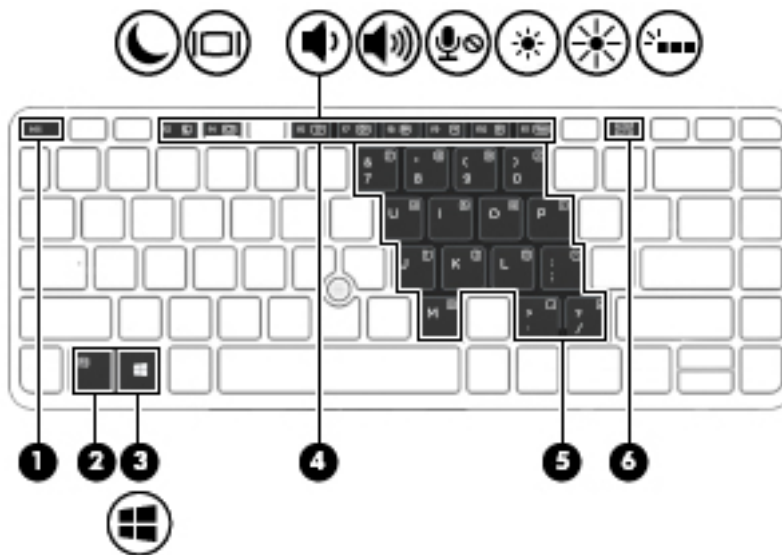



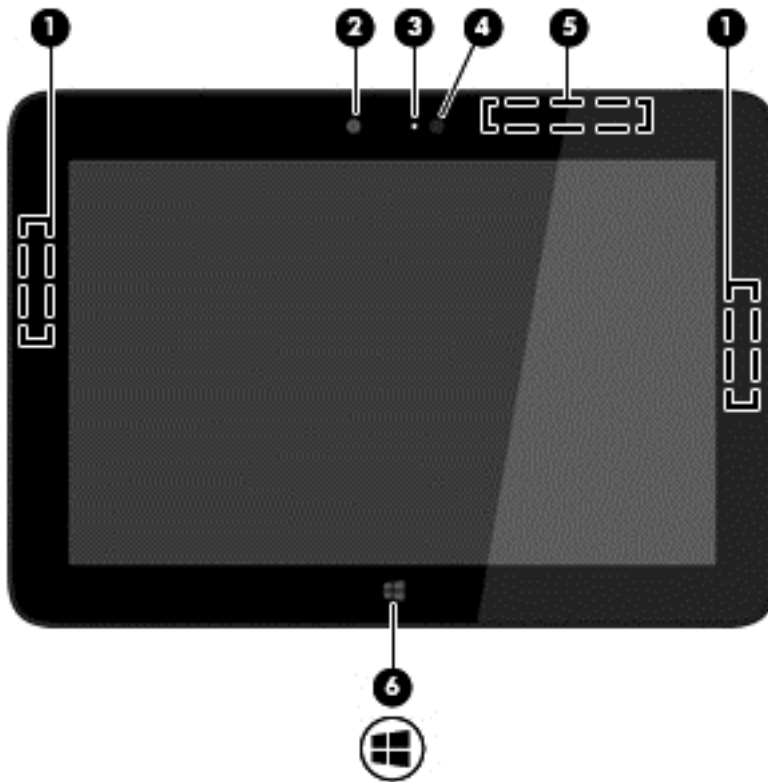

Component	Description
(1) <code>esc</code> key	(Windows only) Displays system information when pressed in combination with the <code>fn</code> key.
(2) <code>fn</code> key	(Windows) Executes frequently used system functions when pressed in combination with a function key, the <code>num lk</code> key, or the <code>esc</code> key. (Linux) Executes frequently used system functions when pressed in combination with a function key.
(3)  Windows button	(Windows only) Returns you to the Start screen from an open app or the Windows desktop. NOTE: Pressing the Windows button again will return you to the previous screen.
(4) Function keys	Execute frequently used system functions when pressed in combination with the <code>fn</code> key.
(5) Embedded numeric keypad	When the keypad is turned on, it can be used like an external numeric keypad.

Component	Description
	Each key on the keypad performs the function indicated by the icon in the upper-right corner of the key.
(6) num lk key	Turns the embedded numeric keypad on and off when pressed in combination with the fn key. (Linux) Alternates between the navigational and numeric functions on the integrated numeric keypad.

Front





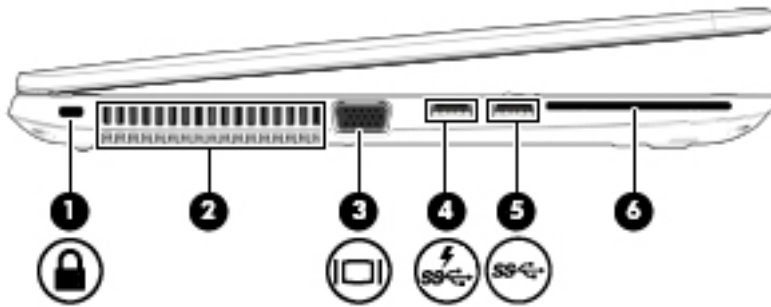

Component	Description
(1)  Wireless light	<ul style="list-style-type: none"> White: An integrated wireless device, such as a wireless local area network (WLAN) device and/or a Bluetooth® device, is on. Amber: All wireless devices are off.
(2)  Power light	<ul style="list-style-type: none"> On: The computer is on. Blinking: The computer is in the Sleep state (Windows) or Suspend state (Linux). Off: The computer is off or in Hibernation (Linux).
(3)  AC adapter/Battery light	<ul style="list-style-type: none"> White: The computer is connected to external power and the battery is charged from 90 to 99 percent. Amber: The computer is connected to external power and the battery is charged from 0 to 90 percent.

Component	Description
(4)  Hard drive light	<ul style="list-style-type: none"> <li data-bbox="919 222 1442 327">• Blinking amber: A battery that is the only available power source has reached a low battery level. When the battery reaches a critical battery level, the battery light begins blinking rapidly. <li data-bbox="919 348 1254 375">• Off: The battery is fully charged.
	<ul style="list-style-type: none"> <li data-bbox="919 394 1394 422">• Blinking white: The hard drive is being accessed. <li data-bbox="919 443 1442 491">• Amber: HP 3D DriveGuard has temporarily parked the hard drive.





Left

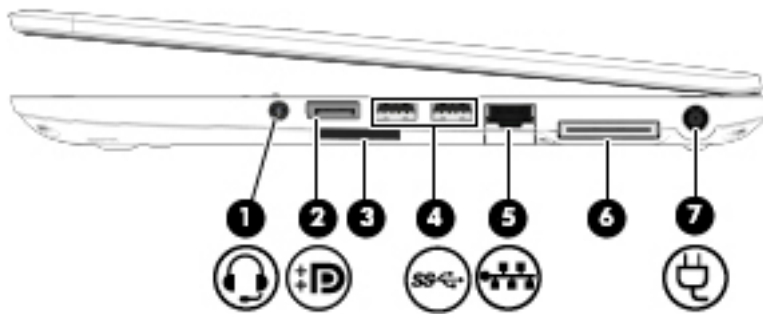

Component	Description
(1)  Security cable slot	Attaches an optional security cable to the computer. NOTE: The security cable is designed to act as a deterrent, but it may not prevent the computer from being mishandled or stolen.
(2) Vent	Enables airflow to cool internal components. NOTE: The computer fan starts up automatically to cool internal components and prevent overheating. It is normal for the internal fan to cycle on and off during routine operation.
(3)  External VGA monitor port	Connects an external VGA monitor or projector.
(4)  USB 3.0 charging port	Connects optional USB 3.0 devices and provides enhanced USB power performance. The USB charging port can also charge select models of cell phones and MP3 players, even when the computer is off.
(5)  USB 3.0 ports (2)	Connect optional USB 3.0 devices and provide enhanced USB power performance.
(6) Smart card reader (select models only)	Supports optional smart cards.

Right





Component	Description
(1)  Audio-out (headphone) jack/Audio-in (microphone) jack	<p>Produces sound when connected to optional powered stereo speakers, headphones, earbuds, a headset, or television audio. Also connects an optional headset microphone.</p> <p>WARNING! To reduce the risk of personal injury, adjust the volume before putting on headphones, earbuds, or a headset. For additional safety information, see the <i>Regulatory, Safety, and Environmental Notices</i>.</p> <p>To access the user guides:</p> <p>Windows 8: Select the HP Support Assistant app on the Start screen, select My computer, and then select User guides.</p> <p>Windows 7: Select Start > Help and Support > User Guides.</p> <p>NOTE: When a device is connected to the jack, the computer speakers are disabled.</p> <p>NOTE: Be sure that the device cable has a 4-conductor connector that supports both audio-out (headphone) and audio-in (microphone).</p>
(2)  DisplayPort	Connects an optional digital display device, such as a high-performance monitor or projector.
(3) Memory card reader	Reads data from and writes data to memory cards such as Secure Digital (SD).
(4)  USB 3.0 ports (2)	Connect optional USB 3.0 devices and provide enhanced USB power performance.
(5)  RJ-45 (network) jack	Connects a network cable.
(6) Docking connector	Connects an optional docking device.
(7)  Power connector	Connects an AC adapter.

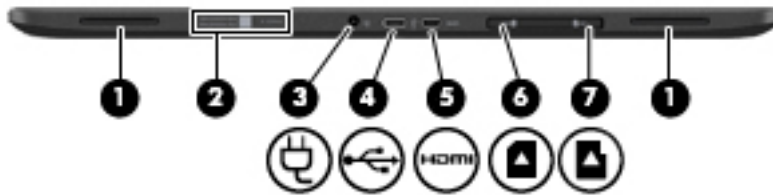

Bottom

 **NOTE:** Your computer may look slightly different from the illustration in this section.

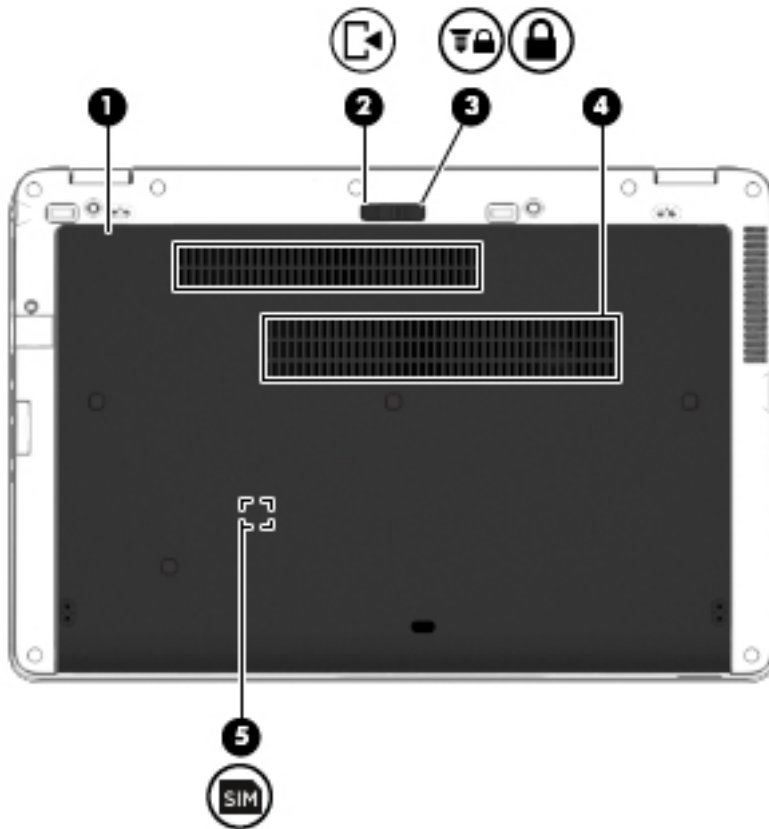

Component	Description
(1)	Accessory battery connector Connects an optional accessory battery.
(2)	Service cover Provides access to the hard drive bay, the wireless LAN (WLAN) module slot, the WWAN module slot, and the memory module slots. CAUTION: To prevent an unresponsive system, replace the wireless module only with a wireless module authorized for use in the computer by the governmental agency that regulates wireless devices in your country or region. If you replace the module and then receive a warning message, remove the module to restore computer functionality, and then contact support through HP Support Assistant. To access HP Support Assistant on the Start screen, select the HP Support Assistant app.
(3)	 Service cover release latch Releases the service cover on the computer.
(4)	 Service cover release lock Locks service cover.
(5)	Vents (2) Enable airflow to cool internal components. NOTE: The computer fan starts up automatically to cool internal components and prevent overheating. It is normal for the internal fan to cycle on and off during routine operation.
(6)	 SIM slot (select models only) Supports a wireless subscriber identity module (SIM). The SIM slot is located inside the battery bay.



Component	Description		
(1)	Service cover	<p>Provides access to the hard drive bay, the wireless LAN (WLAN) module slot, the WWAN module slot, and the memory module slots.</p> <p>CAUTION: To prevent an unresponsive system, replace the wireless module only with a wireless module authorized for use in the computer by the governmental agency that regulates wireless devices in your country or region. If you replace the module and then receive a warning message, remove the module to restore computer functionality, and then contact support through HP Support Assistant. To access HP Support Assistant on the Start screen, select the HP Support Assistant app.</p>	
(2)		Service cover release latch	Releases the service cover on the computer.
(3)		Service cover release lock	Locks the service cover.
(4)	Vents (3)	Enable airflow to cool internal components.	

Component	Description
(5)	 SIM slot (select models only)

NOTE: The computer fan starts up automatically to cool internal components and prevent overheating. It is normal for the internal fan to cycle on and off during routine operation.

Supports a wireless subscriber identity module (SIM). The SIM slot is located inside the battery bay.

Service tag

When ordering parts or requesting information, provide the computer serial number and model number provided on the service tag. It is necessary to remove the battery to obtain these numbers. See [Battery on page 59](#) for battery removal instructions.

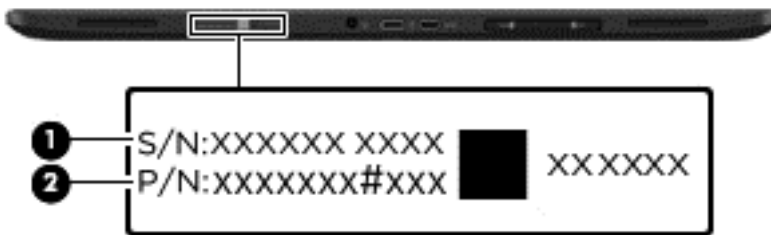

Item	Component	Description
(1)	Product name	This is the product name affixed to the front of the computer.
(2)	Serial number (s/n)	This is an alphanumeric identifier that is unique to each product.
(3)	Part number/Product number (p/n)	This number provides specific information about the product's hardware components. The part number helps a service technician determine what components and parts are needed.
(4)	Warranty period	This number describes the duration of the warranty period for the computer.
(5)	Model description	This is the alphanumeric identifier used to locate documents, drivers, and support for the computer.

3 Illustrated parts catalog

Computer major components

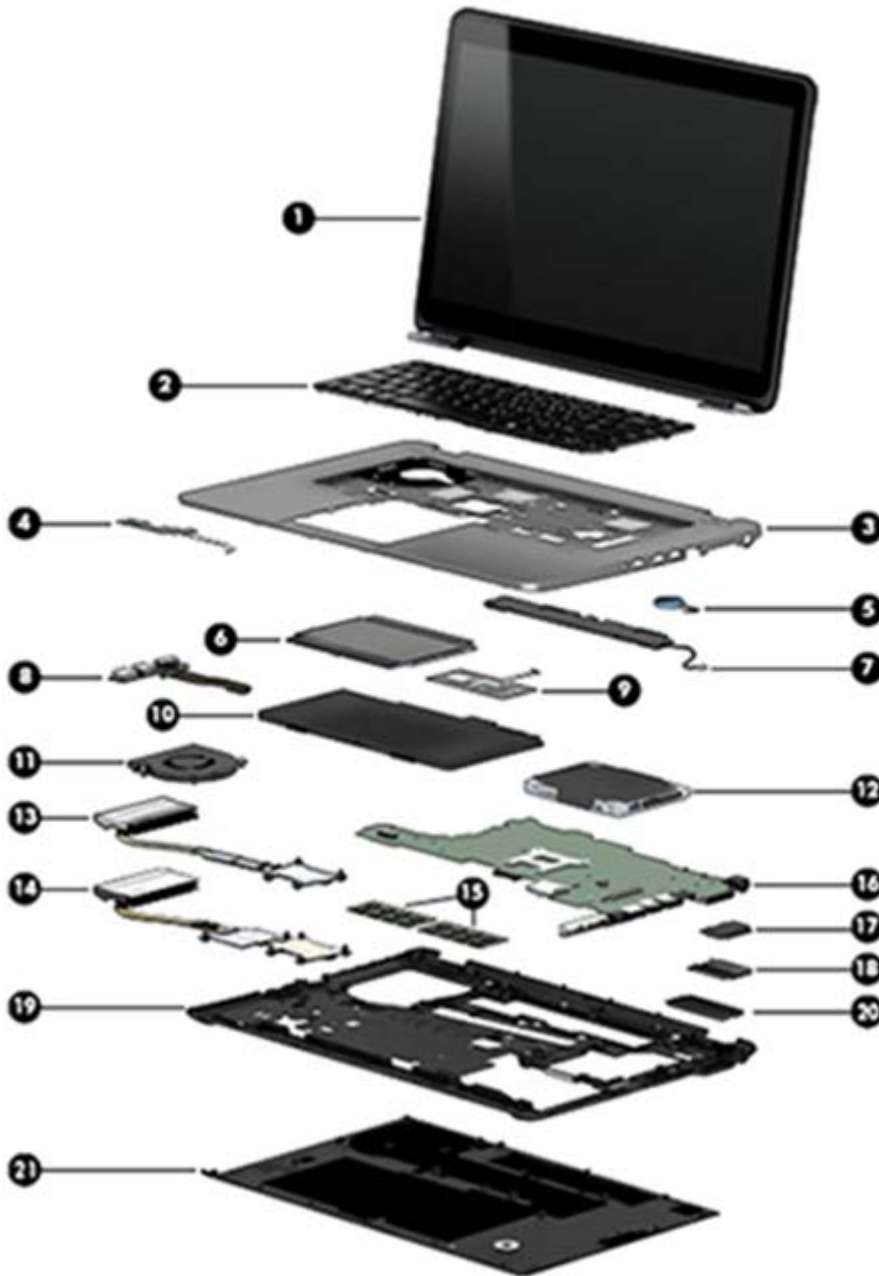

IMPORTANT: For system board (16) replacement on serial numbers xxx501xxxx and below, you must use a conversion kit (see product description for “(Gold Conversion Kit)” in the section marked 16a of the table below). For serial numbers xxx502xxxx and above, use the standard spare kit (see product description for “(Gold)”).

Item	Component	Spare part number
(1)	Display assembly: Non-touch display assemblies are spared at the subcomponent level only. For more display assembly spare part information, see Display assembly subcomponents on page 31 .	
	Touch screen display assemblies are only spared as whole units.	
	Display assembly, 14-inch, HD+, for use in HP EliteBook 740/840 models	737735-001
	Display assembly, 14-inch, HD+, for use in HP ZBook 14 models	739848-001
	Display assembly, 15-inch, HD, for use in HP EliteBook 750/850 models	766680-001
(2)	Keyboard (includes cables)	
	NOTE: For a detailed list of available keyboards, see Sequential part number listing on page 38 .	
	With pointing stick; no backlight	730794-xx1
	Backlit, with pointing stick	731179-xx1
(3)	Top cover (includes TouchPad):	
	For use on HP EliteBook 740/840 models	730964-001
	For use on HP ZBook 14	730965-001
	For use on HP EliteBook 750/850 models	730800-001
(4)	Power button board	
	For use on HP EliteBook 740/840/HP ZBook 14 models	730959-001
	For use on HP EliteBook 750/850 models	730822-001
(5)	RTC battery	665733-001
(6)	Touchpad	
	For use in EliteBook 740/840 models	797437-001
	For use in ZBook 14 models	797438-001
	For use in EliteBook 750/850 models	797431-001
	Card reader board (not illustrated)	
	For use on HP EliteBook 740/840/HP ZBook 14 models	730955-001
	For use on HP EliteBook 750/850 models	730821-001
(7)	Speaker assembly (includes cable)	730798-001
(8)	VGA/USB board	
	For use in HP EliteBook 740/840/HP ZBook 14 models	730966-001
	For use in HP EliteBook 750/850 models	730820-001
(9)	Fingerprint reader board (includes cable, bracket, and insulator)	
	For use in HP EliteBook 740/840/HP ZBook 14 models	730956-001
	For use in HP EliteBook 750/850 models	730817-001
(10)	Battery (Li ion):	
	6-cell, 60-Wh, 2.7-Ah (for use in EliteBook 740/840 and ZBook 14 models)	719796-001

Item	Component	Spare part number
	3-cell, 50-Wh, 4.5-Ah	717376-001
	3-cell, 24-Wh, 2.4-Ah	717375-001
(11)	Fan (includes cable)	730792-001
	Heat sink (includes replacement thermal material):	
(12)	Hard drive (does not include hard drive bracket or screws):	
	1-TB, 7200-rpm (for use in EliteBook 740/840 and ZBook 14 models)	766644-001
	1-TB, 5400-rpm, 2.5-inch	676521-001
	1-TB, 5400-rpm hard drive, locked, for use in EliteBook 740/840 models (does not include hard drive bracket or screws)	776476-001
	1-TB, 5400-rpm, locked	763529-001
	750-GB, 7200-rpm, 2.5-inch, for use in EliteBook 740/840 and ZBook 14 models	633252-001
	500-GB, 7200-rpm, 7-mm, SED	703268-001
	500-GB, 7200-rpm, 2.5-inch, SED	683801-001
	500-GB, 7200-rpm, 7-mm	703267-001
	500-GB, 7200-rpm, 7-mm, locked (HGST), for use in EliteBook 740/840 and ZBook 14 models	782123-001
	500-GB, 5400-rpm, 7-mm	683802-001
	500-GB, 5400-rpm, 7-mm, FIPS	730946-001
	500-GB, 5400-rpm, 7-mm, locked (SGT), for use in EliteBook 740/840 and ZBook 14 models	773555-001
	500-GB, 5400-rpm, 7-mm, locked (SGT), for use in EliteBook 740/840 and ZBook 14 models	776626-001
	320-GB, 7200-rpm, 7-mm	634862-001
	320-GB, 5400-rpm, 7-mm, WD, locked, for use in EliteBook 740/840 and ZBook 14 models	789520-001
	Hard Drive Hardware Kit (not illustrated, includes hard drive bracket and screws)	730793-001
(13)	For use only on HP EliteBook 740/840/HP ZBook 14 models with discrete graphics	730962-001
(14)	For use only on HP EliteBook 740/840/HP ZBook 14 models with UMA graphics	730963-001
	For use only on HP EliteBook 750/850 models with discrete graphics	732626-001
	For use only on HP EliteBook 750/850 models with UMA graphics	730815-001
(15)	Memory modules (PC3L, 12800, 1600-MHz):	
	8-GB memory module	693374-001
	4-GB memory module	691740-001
(16)	System board (includes replacement thermal material):	
	System board for use in models with discrete graphics:	
	<ul style="list-style-type: none"> Intel Core i7-4600U processor for use with the Windows 8 Professional operating system for use in EliteBook 750/850 models (Gold) 	802519-601
	<ul style="list-style-type: none"> Intel Core i7-4600U processor for use with the Windows 8 Standard operating system for use in EliteBook 750/850 models (Gold) 	802519-501

Item	Component	Spare part number
	• Intel Core i7-4600U processor for use with models without the Windows 8 operating system for use in EliteBook 750/850 models (Gold)	802519-001
	• Intel Core i7-4600U processor for use with the Windows 8 Professional operating system (Gold)	802518-601
	• Intel Core i7-4600U processor for use with the Windows 8 Standard operating system (Gold)	802518-501
	• Intel Core i7-4600U processor for use with models without the Windows 8 operating system (Gold)	802518-001
	• Intel Core i7-4600U processor for use with the Windows 8 Professional operating system for use in ZBook 14 models (Gold)	802522-601
	• Intel Core i7-4600U processor for use with the Windows 8 Standard operating system for use in ZBook 14 models (Gold)	802522-501
	• Intel Core i7-4600U processor for use with models without the Windows 8 operating system for use in ZBook 14 models (Gold)	802522-001
	• Intel Core i7-4510U processor for use with the Windows 8 Professional operating system for use in EliteBook 740/840 and 750/850 models (Gold)	802536-601
	• Intel Core i7-4510U processor for use with the Windows 8 Standard operating system for use in EliteBook 740/840 and 750/850 models (Gold)	802536-501
	• Intel Core i7-4510U processor for use with models without the Windows 8 operating system for use in EliteBook 740/840 and 750/850 models (Gold)	802536-001
	• Intel Core i7-4510U processor for use with the Windows 8 Professional operating system for use in ZBook 14 models (Gold)	802528-601
	• Intel Core i7-4510U processor for use with the Windows 8 Standard operating system for use in ZBook 14 models (Gold)	802528-501
	• Intel Core i7-4510U processor for use with models without the Windows 8 operating system for use in ZBook 14 models (Gold)	802528-001
	• Intel Core i7-4500U processor for use with the Windows 8 Professional operating system for use in EliteBook 740/840 and 750/850 models (Gold)	802524-601
	• Intel Core i7-4500U processor for use with the Windows 8 Standard operating system for use in EliteBook 740/840 and 750/850 models (Gold)	802524-501
	• Intel Core i7-4500U processor for use with models without the Windows 8 operating system for use in EliteBook 740/840 and 750/850 models (Gold)	802524-001
	• Intel Core i7-4500U processor for use with the Windows 8 Professional operating system for use in ZBook 14 models (Gold)	802525-601
	• Intel Core i7-4500U processor for use with the Windows 8 Standard operating system for use in ZBook 14 models (Gold)	802525-501
	• Intel Core i7-4500U processor for use with models without the Windows 8 operating system for use in ZBook 14 models (Gold)	802525-001
	• Intel Core i5-4310U processor for use with the Windows 8 Professional operating system for use in EliteBook 740/840 and 750/850 models (Gold)	802534-601
	• Intel Core i5-4310U processor for use with the Windows 8 Standard operating system for use in EliteBook 740/840 and 750/850 models (Gold)	802534-501
	• Intel Core i5-4310U processor for use with models without the Windows 8 operating system for use in EliteBook 740/840 and 750/850 models (Gold)	802534-001

Item	Component	Spare part number
	• Intel Core i5-4310U processor for use with the Windows 8 Professional operating system for use in ZBook 14 models (Gold)	802527-601
	• Intel Core i5-4310U processor for use with the Windows 8 Standard operating system for use in ZBook 14 models (Gold)	802527-501
	• Intel Core i5-4310U processor for use with models without the Windows 8 operating system for use in ZBook 14 models (Gold)	802527-001
	• Intel Core i5-4300U processor for use with the Windows 8 Professional operating system for use in EliteBook 740/840 and 750/850 models (Gold)	802512-601
	• Intel Core i5-4300U processor for use with the Windows 8 Standard operating system for use in EliteBook 740/840 and 750/850 models (Gold)	802512-501
	• Intel Core i5-4300U processor for use with models without the Windows 8 operating system for use in EliteBook 740/840 and 750/850 models (Gold)	802512-001
	• Intel Core i5-4300U processor for use with the Windows 8 Professional operating system for use in ZBook 14 models (Gold)	802521-601
	• Intel Core i5-4300U processor for use with the Windows 8 Standard operating system for use in ZBook 14 models (Gold)	802521-501
	• Intel Core i5-4300U processor for use with models without the Windows 8 operating system for use in ZBook 14 models (Gold)	802521-001
	• Intel Core i5-4210U processor for use with the Windows 8 Professional operating system for use in EliteBook 740/840 and 750/850 models (Gold)	802532-601
	• Intel Core i5-4210U processor for use with the Windows 8 Standard operating system for use in EliteBook 740/840 and 750/850 models (Gold)	802532-501
	• Intel Core i5-4210U processor for use with models without the Windows 8 operating system for use in EliteBook 740/840 and 750/850 models (Gold)	802532-001
	• Intel Core i5-4210U processor for use with the Windows 8 Professional operating system for use in ZBook 14 models (Gold)	802526-601
	• Intel Core i5-4210U processor for use with the Windows 8 Standard operating system for use in ZBook 14 models (Gold)	802526-501
	• Intel Core i5-4210U processor for use with models without the Windows 8 operating system for use in ZBook 14 models (Gold)	802526-001
	• Intel Core i5-4200U processor for use with the Windows 8 Professional operating system for use in EliteBook 740/840 and 750/850 models (Gold)	802517-601
	• Intel Core i5-4200U processor for use with the Windows 8 Standard operating system for use in EliteBook 740/840 and 750/850 models (Gold)	802517-501
	• Intel Core i5-4200U processor for use with models without the Windows 8 operating system for use in EliteBook 740/840 and 750/850 models (Gold)	802517-001
	• Intel Core i5-4200U processor for use with the Windows 8 Professional operating system for use in ZBook 14 models (Gold)	802520-601
	• Intel Core i5-4200U processor for use with the Windows 8 Standard operating system for use in ZBook 14 models (Gold)	802520-501
	• Intel Core i5-4200U processor for use with models without the Windows 8 operating system for use in ZBook 14 models (Gold)	802520-001
	• Intel Core i3-4030U processor for use with the Windows 8 Professional operating system (Gold)	802530-601

Item	Component	Spare part number
	• Intel Core i3-4030U processor for use with the Windows 8 Standard operating system (Gold)	802530-501
	• Intel Core i3-4030U processor for use with models without the Windows 8 operating system (Gold)	802530-001
	• Intel Core i3-4010U processor for use with the Windows 8 Professional operating system (Gold)	802515-601
	• Intel Core i3-4010U processor for use with the Windows 8 Standard operating system (Gold)	802515-501
	• Intel Core i3-4010U processor for use with models without the Windows 8 operating system (Gold)	802515-001
	System board for use in models with UMA graphics:	
	• Intel Core i7-4510U processor for use with the Windows 8 Professional operating system (Gold)	802535-601
	• Intel Core i7-4510U processor for use with the Windows 8 Standard operating system (Gold)	802535-501
	• Intel Core i7-4510U processor for use with models without the Windows 8 operating system (Gold)	802535-001
	• Intel Core i7-4500U processor for use with the Windows 8 Professional operating system (Gold)	802523-601
	• Intel Core i7-4500U processor for use with the Windows 8 Standard operating system (Gold)	802523-501
	• Intel Core i7-4500U processor for use with models without the Windows 8 operating system (Gold)	802523-001
	• Intel Core i5-4310U processor for use with the Windows 8 Professional operating system (Gold)	802533-601
	• Intel Core i5-4310U processor for use with the Windows 8 Standard operating system (Gold)	802533-501
	• Intel Core i5-4310U processor for use with models without the Windows 8 operating system (Gold)	802533-001
	• Intel Core i5-4300U processor for use with the Windows 8 Professional operating system (Gold)	802511-601
	• Intel Core i5-4300U processor for use with the Windows 8 Standard operating system (Gold)	802511-501
	• Intel Core i5-4300U processor for use with models without the Windows 8 operating system (Gold)	802511-001
	• Intel Core i5-4210U processor for use with the Windows 8 Professional operating system (Gold)	802531-601
	• Intel Core i5-4210U processor for use with the Windows 8 Standard operating system (Gold)	802531-501
	• Intel Core i5-4210U processor for use with models without the Windows 8 operating system (Gold)	802531-001
	• Intel Core i5-4200U processor for use with the Windows 8 Professional operating system (Gold)	802516-601
	• Intel Core i5-4200U processor for use with the Windows 8 Standard operating system (Gold)	802516-501
	• Intel Core i5-4200U processor for use with models without the Windows 8 operating system (Gold)	802516-001
	• Intel Core i3-4030U processor for use with the Windows 8 Professional operating system (Gold)	802529-601
	• Intel Core i3-4030U processor for use with the Windows 8 Standard operating system (Gold)	802529-501
	• Intel Core i3-4030U processor for use with models without the Windows 8 operating system (Gold)	802529-001
	• Intel Core i3-4010U processor for use with the Windows 8 Professional operating system (Gold)	802514-601
	• Intel Core i3-4010U processor for use with the Windows 8 Standard operating system (Gold)	802514-501

Item	Component	Spare part number
	<ul style="list-style-type: none"> Intel Core i3-4010U processor for use with models without the Windows 8 operating system (Gold) 	802514-001
(16a)	System board (Gold Conversion Kits) (includes replacement thermal material):	
	System board conversion kit for use in models with discrete graphics:	
	<ul style="list-style-type: none"> Intel Core i7-4600U processor for use with the Windows 8 Professional operating system for use in ZBook 14 models (Gold Conversion Kit) 	802522-6C1
	<ul style="list-style-type: none"> Intel Core i7-4600U processor for use with the Windows 8 Standard operating system for use in ZBook 14 models (Gold Conversion Kit) 	802522-5C1
	<ul style="list-style-type: none"> Intel Core i7-4600U processor for use with models without the Windows 8 operating system for use in ZBook 14 models (Gold Conversion Kit) 	802522-0C1
	<ul style="list-style-type: none"> Intel Core i7-4600U processor for use with the Windows 8 Professional operating system (Gold Conversion Kit) 	802518-6C1
	<ul style="list-style-type: none"> Intel Core i7-4600U processor for use with the Windows 8 Standard operating system (Gold Conversion Kit) 	802518-5C1
	<ul style="list-style-type: none"> Intel Core i7-4600U processor for use with models without the Windows 8 operating system (Gold Conversion Kit) 	802518-0C1
	<ul style="list-style-type: none"> Intel Core i7-4510U processor for use with the Windows 8 Professional operating system for use in ZBook 14 models (Gold Conversion Kit) 	802528-6C1
	<ul style="list-style-type: none"> Intel Core i7-4510U processor for use with the Windows 8 Standard operating system for use in ZBook 14 models (Gold Conversion Kit) 	802528-5C1
	<ul style="list-style-type: none"> Intel Core i7-4510U processor for use with models without the Windows 8 operating system for use in ZBook 14 models (Gold Conversion Kit) 	802528-0C1
	<ul style="list-style-type: none"> Intel Core i7-4510U processor for use with the Windows 8 Professional operating system for use in EliteBook 740/840 and 750/850 models (Gold Conversion Kit) 	802536-6C1
	<ul style="list-style-type: none"> Intel Core i7-4510U processor for use with the Windows 8 Standard operating system for use in EliteBook 740/840 and 750/850 models (Gold Conversion Kit) 	802536-5C1
	<ul style="list-style-type: none"> Intel Core i7-4510U processor for use with models without the Windows 8 operating system for use in EliteBook 740/840 and 750/850 models (Gold Conversion Kit) 	802536-0C1
	<ul style="list-style-type: none"> Intel Core i7-4500U processor for use with the Windows 8 Professional operating system for use in EliteBook 740/840 and 750/850 models (Gold Conversion Kit) 	802524-6C1
	<ul style="list-style-type: none"> Intel Core i7-4500U processor for use with the Windows 8 Standard operating system for use in EliteBook 740/840 and 750/850 models (Gold Conversion Kit) 	802524-5C1
	<ul style="list-style-type: none"> Intel Core i7-4500U processor for use with models without the Windows 8 operating system for use in EliteBook 740/840 and 750/850 models (Gold Conversion Kit) 	802524-0C1
	<ul style="list-style-type: none"> Intel Core i7-4500U processor for use with the Windows 8 Professional operating system for use in ZBook 14 models (Gold Conversion Kit) 	802525-6C1
	<ul style="list-style-type: none"> Intel Core i7-4500U processor for use with the Windows 8 Standard operating system for use in ZBook 14 models (Gold Conversion Kit) 	802525-5C1
	<ul style="list-style-type: none"> Intel Core i7-4500U processor for use with models without the Windows 8 operating system for use in ZBook 14 models (Gold Conversion Kit) 	802525-0C1
	<ul style="list-style-type: none"> Intel Core i5-4310U processor for use with the Windows 8 Professional operating system for use in ZBook 14 models (Gold Conversion Kit) 	802527-6C1

Item	Component	Spare part number
	• Intel Core i5-4310U processor for use with the Windows 8 Standard operating system for use in ZBook 14 models (Gold Conversion Kit)	802527-5C1
	• Intel Core i5-4310U processor for use with models without the Windows 8 operating system for use in ZBook 14 models (Gold Conversion Kit)	802527-0C1
	• Intel Core i5-4310U processor for use with the Windows 8 Professional operating system for use in EliteBook 740/840 and 750/850 models (Gold Conversion Kit)	802534-6C1
	• Intel Core i5-4310U processor for use with the Windows 8 Standard operating system for use in EliteBook 740/840 and 750/850 models (Gold Conversion Kit)	802534-5C1
	• Intel Core i5-4310U processor for use with models without the Windows 8 operating system for use in EliteBook 740/840 and 750/850 models (Gold Conversion Kit)	802534-0C1
	• Intel Core i5-4300U processor for use with the Windows 8 Professional operating system for use in EliteBook 740/840 and 750/850 models (Gold Conversion Kit)	802512-6C1
	• Intel Core i5-4300U processor for use with the Windows 8 Standard operating system for use in EliteBook 740/840 and 750/850 models (Gold Conversion Kit)	802512-5C1
	• Intel Core i5-4300U processor for use with models without the Windows 8 operating system for use in EliteBook 740/840 and 750/850 models (Gold Conversion Kit)	802512-0C1
	• Intel Core i5-4300U processor for use with the Windows 8 Professional operating system for use in ZBook 14 models (Gold Conversion Kit)	802521-6C1
	• Intel Core i5-4300U processor for use with the Windows 8 Standard operating system for use in ZBook 14 models (Gold Conversion Kit)	802521-5C1
	• Intel Core i5-4300U processor for use with models without the Windows 8 operating system for use in ZBook 14 models (Gold Conversion Kit)	802521-0C1
	• Intel Core i5-4210U processor for use with the Windows 8 Professional operating system for use in ZBook 14 models (Gold Conversion Kit)	802526-6C1
	• Intel Core i5-4210U processor for use with the Windows 8 Standard operating system for use in ZBook 14 models (Gold Conversion Kit)	802526-5C1
	• Intel Core i5-4210U processor for use with models without the Windows 8 operating system for use in ZBook 14 models (Gold Conversion Kit)	802526-0C1
	• Intel Core i5-4210U processor for use with the Windows 8 Professional operating system for use in EliteBook 740/840 and 750/850 models (Gold Conversion Kit)	802532-6C1
	• Intel Core i5-4210U processor for use with the Windows 8 Standard operating system for use in EliteBook 740/840 and 750/850 models (Gold Conversion Kit)	802532-5C1
	• Intel Core i5-4210U processor for use with models without the Windows 8 operating system for use in EliteBook 740/840 and 750/850 models (Gold Conversion Kit)	802532-0C1
	• Intel Core i5-4200U processor for use with the Windows 8 Professional operating system for use in ZBook 14 models (Gold Conversion Kit)	802520-6C1
	• Intel Core i5-4200U processor for use with the Windows 8 Standard operating system for use in ZBook 14 models (Gold Conversion Kit)	802520-5C1
	• Intel Core i5-4200U processor for use with models without the Windows 8 operating system for use in ZBook 14 models (Gold Conversion Kit)	802520-0C1
	• Intel Core i5-4200U processor for use with the Windows 8 Professional operating system (Gold Conversion Kit)	802516-6C1
	• Intel Core i5-4200U processor for use with the Windows 8 Standard operating system (Gold Conversion Kit)	802516-5C1

Item	Component	Spare part number
	• Intel Core i5-4200U processor for use with models without the Windows 8 operating system (Gold Conversion Kit)	802516-0C1
	• Intel Core i3-4030U processor for use with the Windows 8 Professional operating system (Gold Conversion Kit)	802530-6C1
	• Intel Core i3-4030U processor for use with the Windows 8 Standard operating system (Gold Conversion Kit)	802530-5C1
	• Intel Core i3-4030U processor for use with models without the Windows 8 operating system (Gold Conversion Kit)	802530-0C1
	• Intel Core i3-4010U processor for use with the Windows 8 Professional operating system (Gold Conversion Kit)	802514-6C1
	• Intel Core i3-4010U processor for use with the Windows 8 Standard operating system (Gold Conversion Kit)	802514-5C1
	• Intel Core i3-4010U processor for use with models without the Windows 8 operating system (Gold Conversion Kit)	802514-0C1
	System board for use in models with UMA graphics:	
	• Intel Core i7-4600U processor for use with the Windows 8 Professional operating system for use in EliteBook 750/850 models (Gold Conversion Kit)	802519-6C1
	• Intel Core i7-4600U processor for use with the Windows 8 Standard operating system for use in EliteBook 750/850 models (Gold Conversion Kit)	802519-5C1
	• Intel Core i7-4600U processor for use with models without the Windows 8 operating system for use in EliteBook 750/850 models (Gold Conversion Kit)	802519-0C1
	• Intel Core i7-4510U processor for use with the Windows 8 Professional operating system (Gold Conversion Kit)	802535-6C1
	• Intel Core i7-4510U processor for use with the Windows 8 Standard operating system (Gold Conversion Kit)	802535-5C1
	• Intel Core i7-4510U processor for use with models without the Windows 8 operating system (Gold Conversion Kit)	802535-0C1
	• Intel Core i7-4500U processor for use with the Windows 8 Professional operating system(Gold Conversion Kit)	802523-6C1
	• Intel Core i7-4500U processor for use with the Windows 8 Standard operating system(Gold Conversion Kit)	802523-5C1
	• Intel Core i7-4500U processor for use with models without the Windows 8 operating system(Gold Conversion Kit)	802523-0C1
	• Intel Core i5-4310U processor for use with the Windows 8 Professional operating system (Gold Conversion Kit)	802533-6C1
	• Intel Core i5-4310U processor for use with the Windows 8 Standard operating system (Gold Conversion Kit)	802533-5C1
	• Intel Core i5-4310U processor for use with models without the Windows 8 operating system (Gold Conversion Kit)	802533-0C1
	• Intel Core i5-4300U processor for use with the Windows 8 Professional operating system (Gold Conversion Kit)	802511-6C1
	• Intel Core i5-4300U processor for use with the Windows 8 Standard operating system (Gold Conversion Kit)	802511-5C1

Item	Component	Spare part number
	• Intel Core i5-4300U processor for use with models without the Windows 8 operating system (Gold Conversion Kit)	802511-0C1
	• Intel Core i5-4210U processor for use with the Windows 8 Professional operating system (Gold Conversion Kit)	802531-6C1
	• Intel Core i5-4210U processor for use with the Windows 8 Standard operating system (Gold Conversion Kit)	802531-5C1
	• Intel Core i5-4210U processor for use with models without the Windows 8 operating system (Gold Conversion Kit)	802531-0C1
	• Intel Core i5-4200U processor for use with the Windows 8 Professional operating system for use in EliteBook 740/840 and 750/850 models (Gold Conversion Kit)	802517-6C1
	• Intel Core i5-4200U processor for use with the Windows 8 Standard operating system for use in EliteBook 740/840 and 750/850 models (Gold Conversion Kit)	802517-5C1
	• Intel Core i5-4200U processor for use with models without the Windows 8 operating system for use in EliteBook 740/840 and 750/850 models (Gold Conversion Kit)	802517-0C1
	• Intel Core i3-4030U processor for use with the Windows 8 Professional operating system (Gold Conversion Kit)	802529-6C1
	• Intel Core i3-4030U processor for use with the Windows 8 Standard operating system (Gold Conversion Kit)	802529-5C1
	• Intel Core i3-4030U processor for use with models without the Windows 8 operating system (Gold Conversion Kit)	802529-0C1
	• Intel Core i3-4010U processor for use with the Windows 8 Professional operating system (Gold Conversion Kit)	802515-6C1
	• Intel Core i3-4010U processor for use with the Windows 8 Standard operating system (Gold Conversion Kit)	802515-5C1
	• Intel Core i3-4010U processor for use with models without the Windows 8 operating system (Gold Conversion Kit)	802515-0C1
(17)	WLAN module:	
	Intel Dual Band Wireless-AC 7260 802.11 ac 2x2 WiFi + BT 4.0	710661-001
	Intel Dual Band Wireless-N 7260AN 802.11 a/b/g/n 2x2 WiFi + BT4.0	717381-001
	Intel Dual Band Wireless-N 7260NB 802.11 a/b/g/n 2x2 WiFi + BT4.0	717382-001
	Broadcom BCM943228HMB 802.11 abgn 2x2 Wi-Fi + BT 4.0 Combo Adapter	697316-001
	Intel Wireless-N 7260BN 802.11 b/g/n 2x2 WiFi + BT 4.0 combo adapter	717384-001
	Intel Dual Band Wireless-N 7260AN 802.11 a/b/g/n 2x2 WiFi + BT4.0 (for use in Indonesia)	747832-001
(18)	WWAN module:	
	HP lt4111 LTE/EV-DO/HSPA+ Mobile Broadband Module	704030-001
	HP lt4112 LTE/HSPA+ Gobi 4G Module	704031-001
	HP hs3110 HSPA+ Mobile Broadband Module	723895-001
(19)	Base enclosure (includes RJ-45 door with spring)	
	For use only on HP EliteBook 740/840 models	765809-001
	For use only on HP ZBook 14 models	765810-001

Item	Component	Spare part number
	For use only on HP EliteBook 750/850 models	730813-001
	For use only on HP EliteBook 750/850 models, ESD	765811-001
	Rubber Kit (not illustrated; includes rubber screw covers):	730796-001
(20)	Solid-state drive (SSD) (includes hard drive bracket and screws)	
	512-GB	752240-001
	256-GB, Self-encrypting drive (SED)	731194-001
	256-GB, Self-encrypting drive (SED), OPAL	766013-001
	256-GB	766643-001
	256-GB, locked (for use only in HP EliteBook 740/840 and ZBook 14 models)	780090-001
	256-GB, Self-encrypting drive (SED), locked	799300-001
	256-GB, locked, SMSG	800584-001
	240-GB	732680-001
	180-GB	732678-001
	180-GB, Self-encrypting drive (SED)	786173-001
	128-GB (for use only in HP EliteBook 750/850 models)	744483-001
	128-GB, locked (for use only in HP EliteBook 740/840 and ZBook 14 models)	766678-001
	128-GB, locked, SanDisk	795941-001
	120-GB	732681-001
	120-GB, M.2 (for use only in HP EliteBook 750/850)	786035-001
	32-GB M.2	743008-001
(21)	Service cover	
	For use only on HP EliteBook 840 models with a touch screen	766324-001
	For use only on HP EliteBook 740 models with a touch screen	784452-001
	For use only on HP EliteBook 840/HP ZBook 14 models; RCTO	745311-001
	For use only on HP ZBook 14 models	730961-001
	For use only on HP EliteBook 850 models with a touch screen	766327-001
	For use only on HP EliteBook 750 models with a touch screen	784479-001
	For use only on HP EliteBook 850 models; for RCTO	745310-001

Display assembly subcomponents

HP EliteBook 740/840/ZBook 14 models

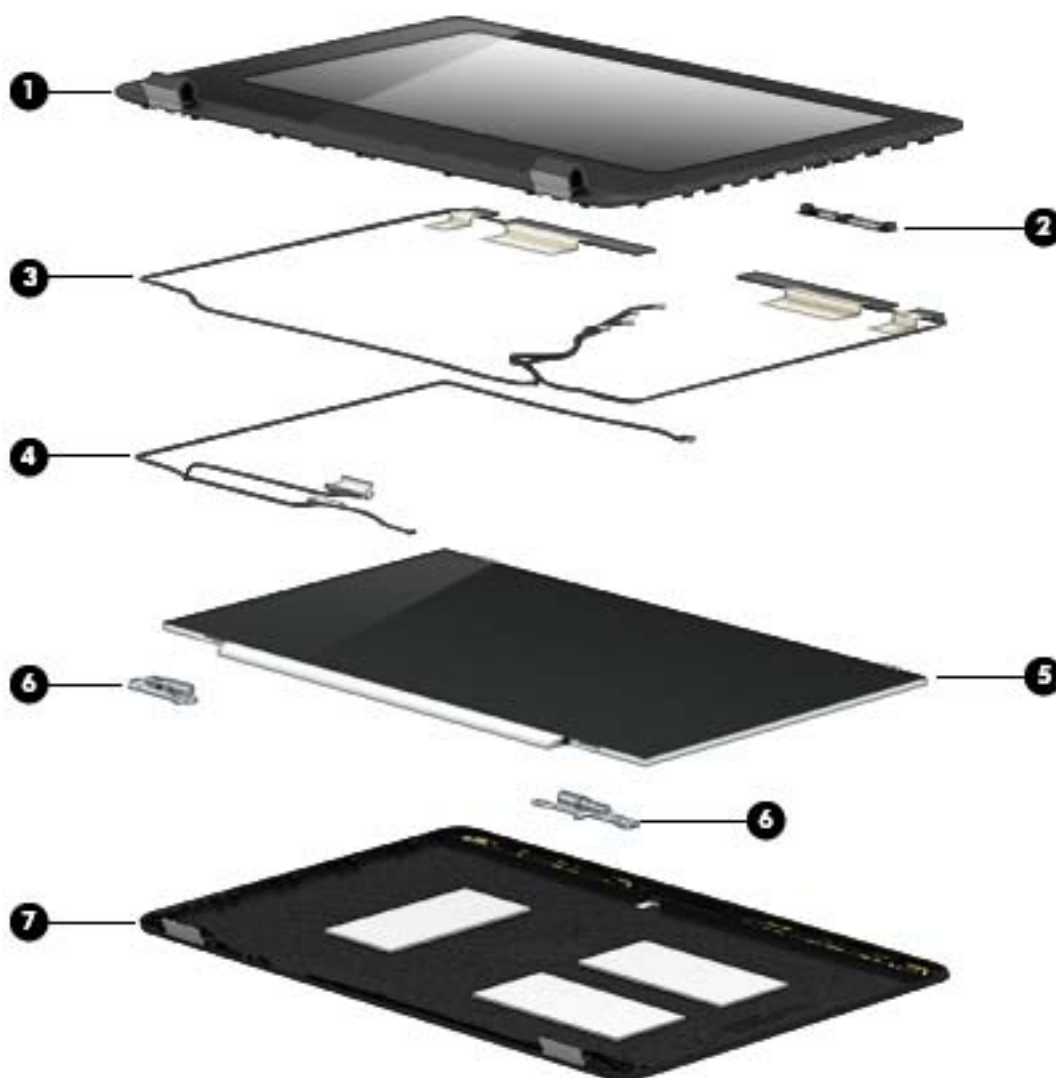

Item	Component	Spare part number
(1)	Display bezel:	
	For use only on HP EliteBook 840 models	730952-001
	For use in HP EliteBook 740 models	784451-001
	For use on HP ZBook 14 models	730953-001
(2)	Webcam	730542-001
	Microphone module (not illustrated)	730795-001
(3)	Antenna cables and transceivers (WLAN and WWAN)	730947-001
(4)	Display panel cable (includes webcam/microphone module cable)	730954-001

Item	Component	Spare part number
(5)	(35.6-cm) 14.0-in, LED, AntiGlare display panel:	
	HD, SVA (1366×768), 200 nits	737657-001
	HD+, SVA (1920×1080), 250 nits	737658-001
	FHD, SVA (1920×1080) 300 nits	737659-001
(6)	Display Hinge Kit (includes left and right hinges and hinge covers):	
	For use in HP EliteBook 740/840 models	730957-001
	For use in HP ZBook 14 models	737660-001
(7)	Display enclosure (includes 4 transceivers with antennas)	
	For use in HP EliteBook 740/840 models	730949-001
	For use in HP ZBook 14 models	730948-001

HP EliteBook 750/850 models

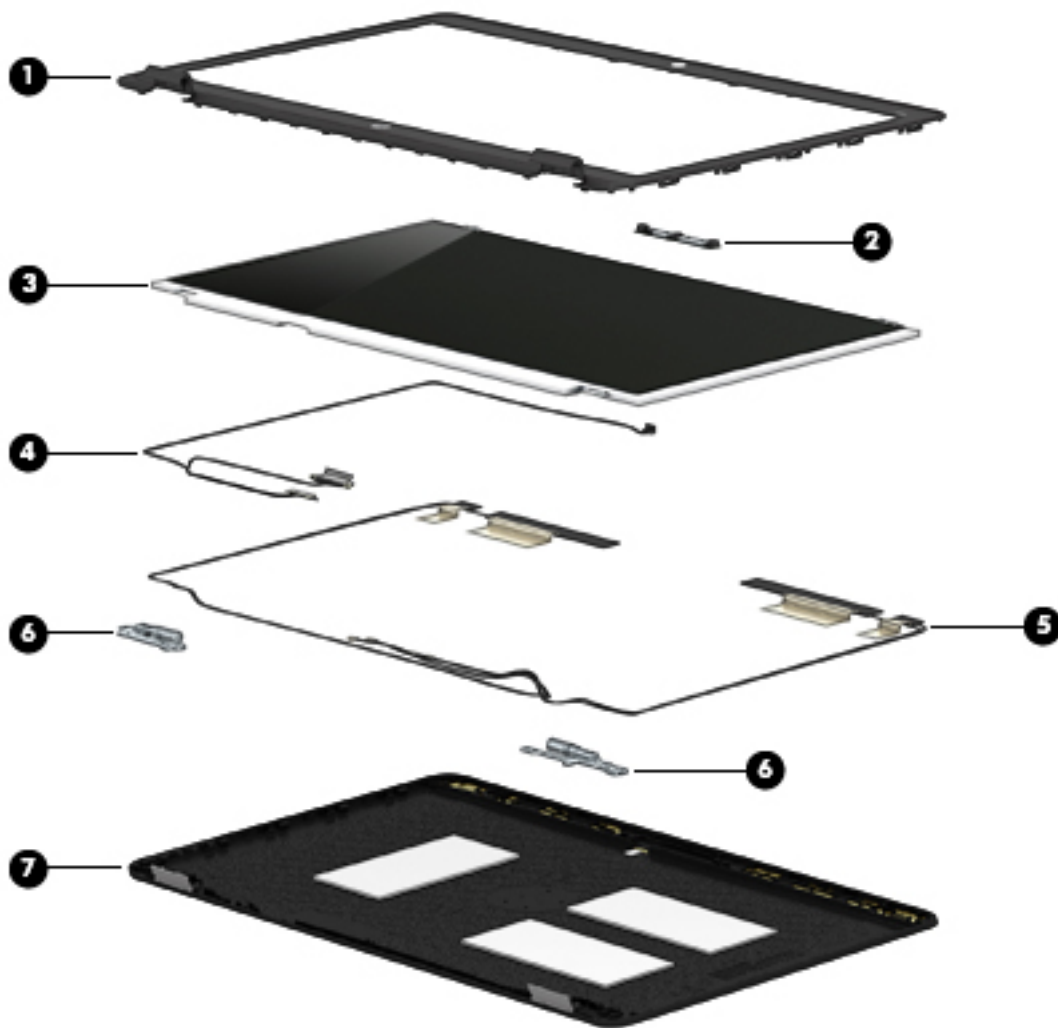

Item	Component	Spare part number
(1)	Display bezel	
	For use in HP EliteBook 850 models	730814-001
	For use in HP EliteBook 750 models	784478-001
(2)	Webcam	730542-001
	Microphone module (not illustrated)	730795-001
(3)	(39.6-cm) 15.6-in, LED, AntiGlare display panel:	
	FHD, SVA (1920×1080) 200 nits	733684-001
	HD, SVA (1368×768) 300 nits	733685-001
(4)	Display panel cable (includes webcam/microphone module cable)	730801-001
(5)	Antenna cables and transceivers (WLAN and WWAN)	736678-001
(6)	Display Hinge Kit (includes left and right hinges and hinge covers):	730819-001
(7)	Display enclosure (includes 4 transceivers with antennas)	730811-001

Mass storage devices

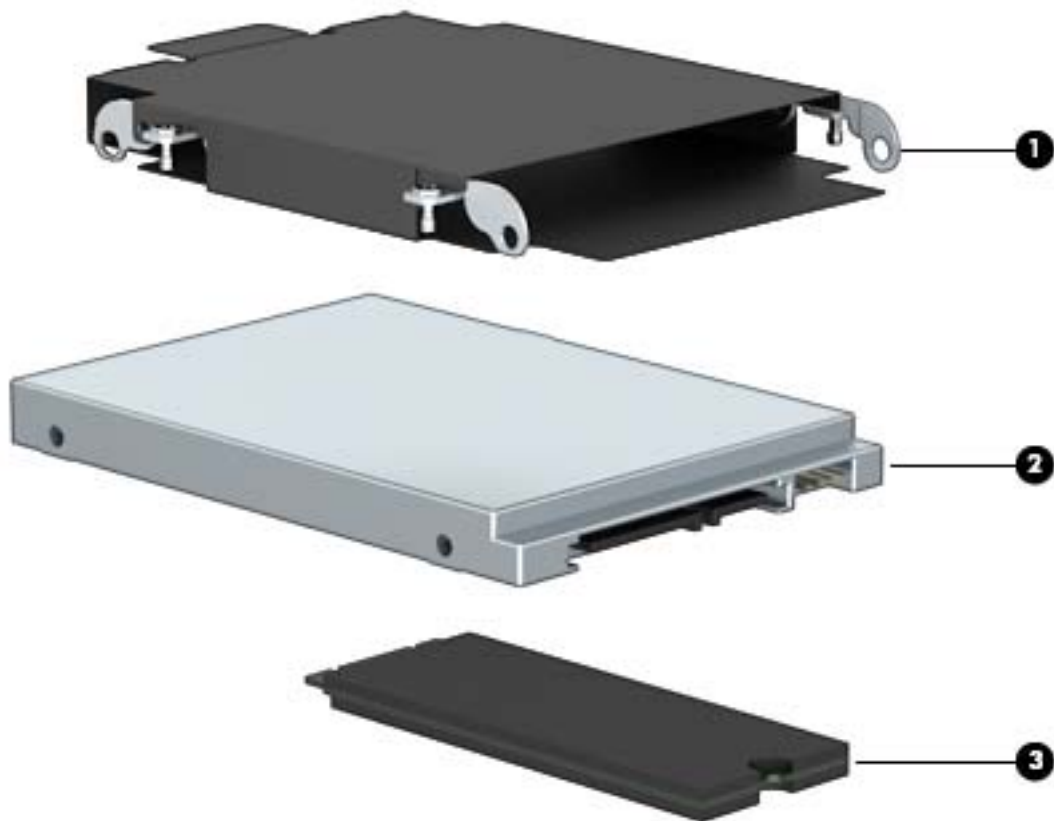

Item	Description	Spare part number
(1)	Hard Drive Hardware Kit , includes bracket	730793-001

Item	Description	Spare part number
(2)	Hard drive (does not include hard drive bracket or screws):	
	1-TB, 7200-rpm (for use in EliteBook 740/840 and ZBook 14 models)	766644-001
	1-TB, 5400-rpm, 2.5-inch	676521-001
	1-TB, 5400-rpm, locked (for use in EliteBook 750/850 models)	776476-001
	1-TB, 5400-rpm, locked	763529-001
	750-GB, 7200-rpm, 2.5-inch (for use in EliteBook 740/840 and ZBook 14 models)	633252-001
	500-GB, 7200-rpm, 7-mm, SED	703268-001
	500-GB, 7200-rpm, 2.5-inch, SED	683801-001
	500-GB, 7200-rpm, 7-mm	703267-001
	500-GB, 7200-rpm, 7-mm, locked (HGST)(for use in EliteBook 740/840 and ZBook 14 models)	782123-001
	500-GB, 5400-rpm, 7-mm	683802-001
	500-GB, 5400-rpm, 7-mm, FIPS	730946-001
	500-GB, 5400-rpm, 7-mm, locked (SGT)(for use in EliteBook 740/840 and ZBook 14 models)	773555-001
	500-GB, 5400-rpm, 7-mm, locked (SGT)(for use in EliteBook 740/840 and ZBook 14 models)	776626-001
	320-GB, 7200-rpm, 7-mm	634862-001
	320-GB, 5400-rpm, 7-mm, WD, locked (for use in EliteBook 740/840 and ZBook 14 models)	789520-001
(3)	Solid-state drive (includes hard drive bracket and screws):	
	512-GB	752240-001
	256-GB, Self-encrypting drive (SED)	731194-001
	256-GB, Self-encrypting drive (SED), OPAL	766013-001
	256-GB	766643-001
	256-GB, locked (for use only in HP EliteBook 740/840 and ZBook 14 models)	780090-001
	256-GB, Self-encrypting drive (SED), locked	799300-001
	256-GB, locked, SMSG	800584-001
	240-GB	732680-001
	180-GB	732678-001
	180-GB, Self-encrypting drive (SED)	786173-001
	128-GB (for use only in HP EliteBook 15 models)	744483-001
	128-GB, locked (for use only in HP EliteBook 740/840 and ZBook 14 models)	766678-001
	128-GB, locked, SanDisk	795941-001
	120-GB	732681-001

Item	Description	Spare part number
	120-GB, M.2 (for use only in HP EliteBook 750/850)	786035-001
	32-GB	743008-001

Plastics Kit

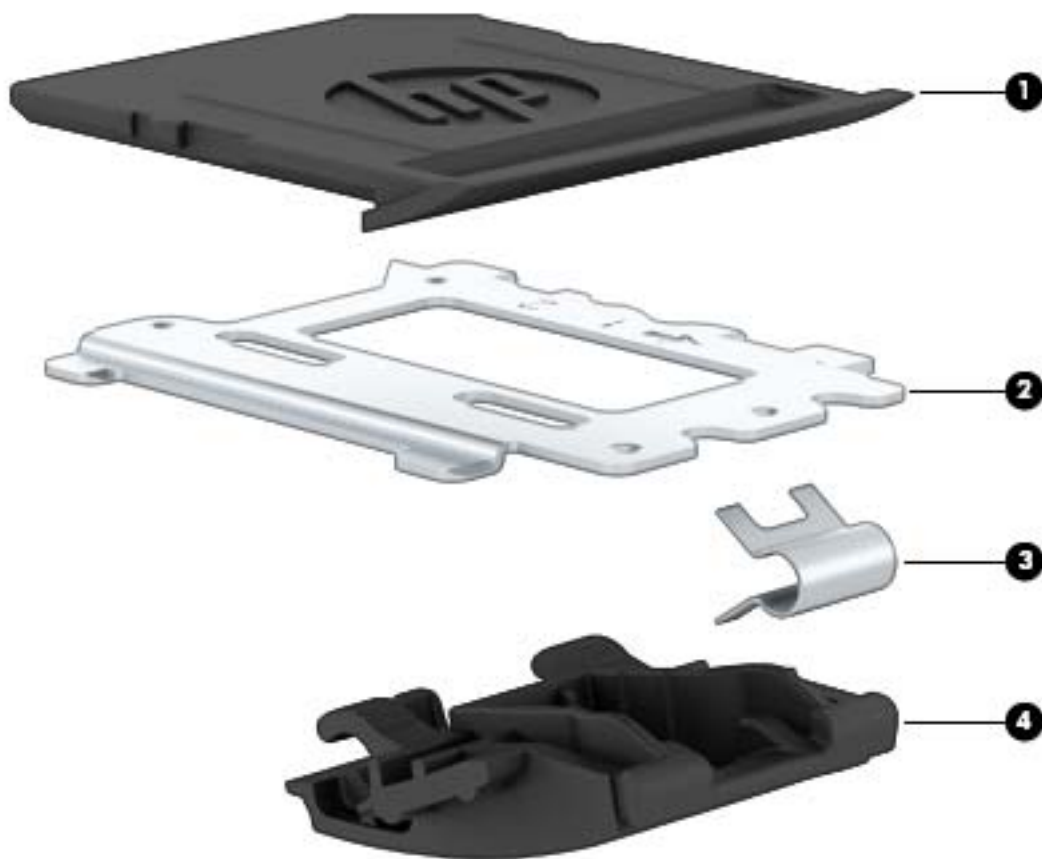

Item	Description	Spare part number
	Plastics Kit for use only on HP EliteBook 740/840 models	730958-001
	Plastics Kit for use only on HP ZBook 14 models	739558-001
	Plastics Kit for use only on HP EliteBook 750/850 models	730802-001
(1)	SD card insert, illustrated	
(2)	Fingerprint reader insert	
(3)	RJ-45 spring	
(4)	RJ-45 door	

Miscellaneous parts

Component	Spare part number
AC adapter:	
90-W HP Smart AC adapter (PFC) for use only in Elitebook 750/850 models	693712-001
45-W HP Smart AC adapter (non-PFC, EM, 3-wire)	742437-001
65-W HP Smart AC travel adapter (non-PFC)	693716-001
65-W HP Smart AC adapter (non-PFC, 3-wire)	693711-001
65-W HP Smart AC adapter (RC/V, EM, 3-wire) for use in India and the People's Republic of China	693710-001
Power cord (3-pin, black, 1.83-m):	
For use in Argentina	490371-D01
For use in Australia	490371-011
For use in Brazil	490371-202
For use in Denmark	490371-081
For use in Europe	490371-021
For use in India	490371-D61
For use in Israel	490371-BB1
For use in Italy	490371-061
For use in Japan	490371-291
For use in North America	490371-001
For use in the People's Republic of China	490371-AA1
For use in South Africa	490371-AR1
For use in South Korea	490371-AD1
For use in Switzerland	490371-111
For use in Taiwan	490371-AB1
For use in Thailand	490371-201
For use in the United Kingdom and Singapore	490371-031
Power cord (3-pin, black, 1.83-m):	
For use in Argentina	755530-D01
For use in Australia	755530-011
For use in Brazil	755530-202
For use in the People's Republic of China	755530-AA1
For use in Denmark	755530-081
For use in Europe	755530-021
For use in India	755530-D61
For use in Israel	755530-BB1

Component	Spare part number
For use in Italy	755530-061
For use in Japan	755530-291
For use in North America	755530-001
For use in South Africa	755530-AR1
For use in South Korea	755530-AD1
For use in Switzerland	755530-111
For use in Taiwan	755530-AB1
For use in Thailand	755530-201
For use in the United Kingdom and Singapore	755530-031
Power cord, 1.8 m, 2-pin, for use in Japan	753361-001
Power cord, 1.0 m, 2-pin, for use in Japan	762689-001
Travel Smart DC cable, 3 W	630380-001
Cable lock	575921-001
Mouse	
USB, optical, travel	434594-001
USB, laser	674318-001
Screw Kit	730797-001
Cases	
Professional top load case	705621-001
Top load case	679921-001
HP Business Slim Top Load Case	718549-001
HP Business Top Load Case	718550-001
Display Port to HDMI adapter	617450-001

Sequential part number listing

CSR flag designations:

A = Mandatory

B = Optional

C = Service technician recommended

N = Non-user replaceable



IMPORTANT: For system board replacement on serial numbers xxx501xxxx and below, you must use a conversion kit (see product description for “(Gold Conversion Kit)”). For serial numbers xxx502xxxx and above, use the standard spare kit (see product description for “(Gold)”).

Spare part number	CSR flag	Description
490371-001	A	Power cord for use on all computer models in North America (3-pin, black, 1.83-m)
490371-011	A	Power cord for use on all computer models in Australia (3-pin, black, 1.83-m)
490371-021	A	Power cord for use on all computer models in Europe (3-pin, black, 1.83-m)
490371-031	A	Power cord for use on all computer models in the United Kingdom and Singapore (3-pin, black, 1.83-m)
490371-061	A	Power cord for use on all computer models in Italy (3-pin, black, 1.83-m)
490371-081	A	Power cord for use on all computer models in Denmark (3-pin, black, 1.83-m)
490371-111	A	Power cord for use on all computer models in Switzerland (3-pin, black, 1.83-m)
490371-201	A	Power cord for use on all computer models in Thailand (3-pin, black, 1.83-m)
490371-202	A	Power cord for use on all computer models in Brazil (3-pin, black, 1.83-m)
490371-291	A	Power cord for use on all computer models in Japan (3-pin, black, 1.83-m)
490371-AA1	A	Power cord for use on all computer models in the People's Republic of China (3-pin, black, 1.83-m)
490371-AB1	A	Power cord for use on all computer models in Taiwan (3-pin, black, 1.83-m)
490371-AD1	A	Power cord for use on all computer models in South Korea (3-pin, black, 1.83-m)
490371-AR1	A	Power cord for use on all computer models in South Africa (3-pin, black, 1.83-m)
490371-BB1	A	Power cord for use on all computer models in Israel (3-pin, black, 1.83-m)
490371-D01	A	Power cord for use on all computer models in Argentina (3-pin, black, 1.83-m)
572511-001	A	Intel Centrino Ultimate-N 6300 WLAN module
575921-001	A	Cable lock
617450-001	A	Display Port to HDMI adapter
630380-001	A	Travel Smart DC cable, 3 W
633252-001	A	750-GB, 7200-rpm, 2.5-inch (for use in EliteBook 740/840 and ZBook 14 models)
634862-001	A	320-GB, 5400-rpm, 7-mm hard drive (does not include hard drive bracket or screws)
665733-001	N	RTC battery
674318-001	A	Mouse, USB, laser

Spare part number	CSR flag	Description
676521-001	A	1-TB, 5400-rpm, 2.5-inch hard drive (does not include hard drive bracket or screws)
679921-001	A	Top load case
683801-001	A	500-GB, 7200-rpm, 2.5-inch, SED hard drive (does not include hard drive bracket or screws)
683802-001	A	500-GB, 5400-rpm, 7-mm hard drive (does not include hard drive bracket or screws)
691740-001	A	4-GB memory module (PC3L, 12800, 1600-MHz)
693374-001	A	8-GB memory module (PC3L, 12800, 1600-MHz)
693710-001	A	65-W HP Smart AC adapter (RC/V, EM, 3-wire) for use in India and the People's Republic of China
693711-001	A	65-W HP Smart AC adapter (non-PFC, 3-wire)
693712-001	A	90-W HP Smart AC adapter (PFC) for use only in Elitebook 750/850 models
693716-001	A	90-W HP Smart AC travel adapter (non-PFC)
697316-001	A	Broadcom BCM943228HMB 802.11 abgn 2x2 Wi-Fi + BT 4.0 Combo Adapter
703267-001	A	500-GB, 7200-rpm, 7-mm hard drive (does not include hard drive bracket or screws)
703268-001	A	500-GB, 7200-rpm, 7-mm, SED hard drive (does not include hard drive bracket or screws)
704030-001	A	HP It4111 LTE/EV-DO/HSPA+ Mobile Broadband Module
704031-001	A	HP It4112 LTE/HSPA+ Gobi 4G Module
705621-001	A	Professional top load case
710661-001	A	Intel Dual Band Wireless-AC 7260 802.11 ac 2x2 WiFi + BT 4.0 WLAN module
717375-001	A	3-cell, 24-Wh, 2.40-Ah, Li-ion battery
717376-001	A	3-cell, 50-Wh, 4.50-Ah, Li-ion battery
717381-001	A	Intel Dual Band Wireless-N 7260AN 802.11 a/b/g/n 2x2 WiFi + BT4.0
717382-001	A	Intel Dual Band Wireless-N 7260NB 802.11 a/b/g/n 2x2 WiFi + BT4.0
717384-001	A	Intel Wireless-N 7260BN 802.11 b/g/n 2x2 WiFi + BT 4.0 combo adapter
718549-001	A	HP Business Slim Top Load Case
718550-001	A	HP Business Top Load Case
719796-001	A	6-cell, 60-Wh, 2.7-Ah, Li-ion battery (for use in EliteBook 740/840 and ZBook 14 models)
723895-001	A	HP hs3110 HSPA+ Mobile Broadband Module
730542-001	N	Webcam module
730792-001	C	Fan (includes cable)
730793-001	A	Hard Drive Hardware Kit (includes the hard drive bracket and screws)
730794-001	B	Keyboard with pointing stick for use in the United States (includes keyboard cable and pointing stick cable)
730794-031	B	Keyboard with pointing stick for use in the United Kingdom and Singapore (includes keyboard cable and pointing stick cable)
730794-041	B	Keyboard with pointing stick for use in Germany (includes keyboard cable and pointing stick cable)

Spare part number	CSR flag	Description
730794-051	B	Keyboard with pointing stick for use in France (includes keyboard cable and pointing stick cable)
730794-061	B	Keyboard with pointing stick for use in Italy (includes keyboard cable and pointing stick cable)
730794-071	B	Keyboard with pointing stick for use in Spain (includes keyboard cable and pointing stick cable)
730794-081	B	Keyboard with pointing stick for use in Denmark (includes keyboard cable and pointing stick cable)
730794-091	B	Keyboard with pointing stick for use in Norway (includes keyboard cable and pointing stick cable)
730794-131	B	Keyboard with pointing stick for use in Portugal (includes keyboard cable and pointing stick cable)
730794-141	B	Keyboard with pointing stick for use in Turkey (includes keyboard cable and pointing stick cable)
730794-151	B	Keyboard with pointing stick for use in Greece (includes keyboard cable and pointing stick cable)
730794-161	B	Keyboard with pointing stick for use in Latin America (includes keyboard cable and pointing stick cable)
730794-171	B	Keyboard with pointing stick for use in Saudi Arabia (includes keyboard cable and pointing stick cable)
730794-201	B	Keyboard with pointing stick for use in Brazil (includes keyboard cable and pointing stick cable)
730794-211	B	Keyboard with pointing stick for use in Hungary (includes keyboard cable and pointing stick cable)
730794-251	B	Keyboard with pointing stick for use in Russia (includes keyboard cable and pointing stick cable)
730794-261	B	Keyboard with pointing stick for use in Bulgaria (includes keyboard cable and pointing stick cable)
730794-271	B	Keyboard with pointing stick for use in Romania (includes keyboard cable and pointing stick cable)
730794-281	B	Keyboard with pointing stick for use in Thailand (includes keyboard cable and pointing stick cable)
730794-291	B	Keyboard with pointing stick for use in Japan (includes keyboard cable and pointing stick cable)
730794-A41	B	Keyboard with pointing stick for use in Belgium (includes keyboard cable and pointing stick cable)
730794-AB1	B	Keyboard with pointing stick for use in Taiwan (includes keyboard cable and pointing stick cable)
730794-AD1	B	Keyboard with pointing stick for use in South Korea (includes keyboard cable and pointing stick cable)
730794-B31	B	Keyboard with pointing stick for use in the Netherlands (includes keyboard cable and pointing stick cable)
730794-B71	B	Keyboard with pointing stick for use in Sweden and Finland (includes keyboard cable and pointing stick cable)
730794-BA1	B	Keyboard with pointing stick for use in Slovenia (includes keyboard cable and pointing stick cable)
730794-BB1	B	Keyboard with pointing stick for use in Israel (includes keyboard cable and pointing stick cable)
730794-BG1	B	Keyboard with pointing stick for use in Switzerland (includes keyboard cable and pointing stick cable)
730794-D61	B	Keyboard with pointing stick for use in India (includes keyboard cable and pointing stick cable)
730794-DB1	B	Keyboard with pointing stick for use in Canada (includes keyboard cable and pointing stick cable)
730794-DD1	B	Keyboard with pointing stick for use in Iceland (includes keyboard cable and pointing stick cable)
730794-FL1	B	Keyboard with pointing stick for use in the Czech Republic and Slovakia (includes keyboard cable and pointing stick cable)
730794-FP1	B	Keyboard with pointing stick for use in Northwest Africa (includes keyboard cable and pointing stick cable)
730795-001	N	Microphone module

Spare part number	CSR flag	Description
730796-001	A	Rubber Kit (includes rubber screw covers)
730797-001	N	Screw Kit
730798-001	N	Speaker assembly (includes cable)
730800-001	N	Top cover for use only on HP EliteBook 750/850 models (includes TouchPad)
730801-001	N	Display panel cable for use only on HP EliteBook 750/850 models
730802-001	N	Plastics Kit for use only on HP EliteBook 850 models (includes SD card insert, RJ-45 door, fingerprint reader insert, and RJ-45 spring)
730811-001	N	Display enclosure for use in HP EliteBook 850 models (includes 4 transceivers with antennas)
730813-001	C	Base enclosure for use only on HP EliteBook 750/850 models, ESD (includes RJ-45 door with spring)
730814-001	A	Display bezel for use only on HP EliteBook 850 models
730815-001	N	Heat sink for use only on HP EliteBook 750/850 models with UMA graphics (includes replacement thermal material)
730817-001	N	Fingerprint reader assembly for use in HP EliteBook 750/850 models (includes cable, bracket, and insulator)
730819-001	N	Display Hinge Kit for use only on HP EliteBook 750/850 models (includes left and right hinges and hinge covers)
730820-001	C	VGA/USB board for use in HP EliteBook 750/850 models
730821-001	C	Card reader board for use in HP EliteBook 850 models
730822-001	N	Power button board for use in HP EliteBook 750/850 models
730946-001	A	500-GB, 5400-rpm, 7-mm, FIPS hard drive (does not include hard drive bracket or screws)
730947-001	N	Antennas (WLAN, WWAN) for use only on HP EliteBook 740/840/HP ZBook 14 models
730948-001	N	Display enclosure for use in HP ZBook 14 models (includes 4 transceivers with antennas)
730949-001	N	Display enclosure for use in HP EliteBook 740/840 models (includes 4 transceivers with antennas)
730952-001	N	Display bezel for use only on HP EliteBook 840 models
730953-001	N	Display bezel for use only on HP ZBook 14 models
730954-001	N	Display panel cable for use only on HP EliteBook 740/840/HP ZBook 14 models
730955-001	C	Card reader board for use in HP EliteBook 740/840/ZBook 14 models
730956-001	N	Fingerprint reader assembly for use in HP EliteBook 740/840/HP ZBook 14 models (includes cable, bracket, and insulator)
730957-001	N	Display Hinge Kit for use only on HP EliteBook 740/840 models (includes left and right hinges and hinge covers)
730958-001	C	Plastics Kit for use only on HP EliteBook 740/840 models (includes SD card insert, RJ-45 door, fingerprint reader insert, and RJ-45 spring)
730959-001	N	Power button board for use in HP EliteBook 740/840/HP ZBook 14 models
730961-001	A	Service cover for use only on HP ZBook 14 models
730962-001	N	Heat sink for use only on HP EliteBook 740/840/HP ZBook 14 models with discrete graphics (includes replacement thermal material)

Spare part number	CSR flag	Description
730963-001	N	Heat sink for use only on HP EliteBook 740/840/HP ZBook 14 models with UMA graphics (includes replacement thermal material)
730964-001	N	Top cover for use only on HP EliteBook 740/840 models (includes TouchPad)
730965-001	N	Top cover for use only on HP EZBook 14 models (includes TouchPad)
730966-001	C	VGA/USB board for use in HP EliteBook 740/840/HP ZBook 14 models
731179-001	B	Keyboard, backlit, with pointing stick for use in the United States (includes keyboard cable and pointing stick cable)
731179-031	B	Keyboard, backlit, with pointing stick for use in the United Kingdom and Singapore (includes keyboard cable and pointing stick cable)
731179-041	B	Keyboard, backlit, with pointing stick for use in Germany (includes keyboard cable and pointing stick cable)
731179-051	B	Keyboard, backlit, with pointing stick for use in France (includes keyboard cable and pointing stick cable)
731179-061	B	Keyboard, backlit, with pointing stick for use in Italy (includes keyboard cable and pointing stick cable)
731179-071	B	Keyboard, backlit, with pointing stick for use in in Spain (includes keyboard cable and pointing stick cable)
731179-081	B	Keyboard, backlit, with pointing stick for use in in Denmark (includes keyboard cable and pointing stick cable)
731179-091	B	Keyboard, backlit, with pointing stick for use in Norway (includes keyboard cable and pointing stick cable)
731179-131	B	Keyboard, backlit, with pointing stick for use in Portugal (includes keyboard cable and pointing stick cable)
731179-141	B	Keyboard, backlit, with pointing stick for use in Turkey (includes keyboard cable and pointing stick cable)
731179-151	B	Keyboard, backlit, with pointing stick for use in Greece (includes keyboard cable and pointing stick cable)
731179-161	B	Keyboard, backlit, with pointing stick for use in Latin America (includes keyboard cable and pointing stick cable)
731179-171	B	Keyboard, backlit, with pointing stick for use in Saudi Arabia (includes keyboard cable and pointing stick cable)
731179-201	B	Keyboard, backlit, with pointing stick for use in Brazil (includes keyboard cable and pointing stick cable)
731179-211	B	Keyboard, backlit, with pointing stick for use in Hungary (includes keyboard cable and pointing stick cable)
731179-251	B	Keyboard, backlit, with pointing stick for use in Russia (includes keyboard cable and pointing stick cable)
731179-261	B	Keyboard, backlit, with pointing stick for use in Bulgaria (includes keyboard cable and pointing stick cable)
731179-271	B	Keyboard, backlit, with pointing stick for use in Romania (includes keyboard cable and pointing stick cable)
731179-281	B	Keyboard, backlit, with pointing stick for use in Thailand (includes keyboard cable and pointing stick cable)
731179-291	B	Keyboard, backlit, with pointing stick for use in Japan (includes keyboard cable and pointing stick cable)
731179-A41	B	Keyboard, backlit, with pointing stick for use in Belgium (includes keyboard cable and pointing stick cable)

Spare part number	CSR flag	Description
731179-AB1	B	Keyboard, backlit, with pointing stick for use in Taiwan (includes keyboard cable and pointing stick cable)
731179-AD1	B	Keyboard, backlit, with pointing stick for use in South Korea (includes keyboard cable and pointing stick cable)
731179-B31	B	Keyboard, backlit, with pointing stick for use in the Netherlands (includes keyboard cable and pointing stick cable)
731179-B71	B	Keyboard, backlit, with pointing stick for use in Sweden and Finland (includes keyboard cable and pointing stick cable)
731179-BA1	B	Keyboard, backlit, with pointing stick for use in Slovenia (includes keyboard cable and pointing stick cable)
731179-BB1	B	Keyboard, backlit, with pointing stick for use in Israel (includes keyboard cable and pointing stick cable)
731179-BG1	B	Keyboard, backlit, with pointing stick for use in Switzerland (includes keyboard cable and pointing stick cable)
731179-D61	B	Keyboard, backlit, with pointing stick for use in India (includes keyboard cable and pointing stick cable)
731179-DB1	B	Keyboard, backlit, with pointing stick for use in Canada (includes keyboard cable and pointing stick cable)
731179-DD1	B	Keyboard, backlit, with pointing stick for use in Iceland (includes keyboard cable and pointing stick cable)
731179-FL1	B	Keyboard, backlit, with pointing stick for use in the Czech Republic and Slovakia (includes keyboard cable and pointing stick cable)
731179-FP1	B	Keyboard, backlit, with pointing stick for use in Northwest Africa (includes keyboard cable and pointing stick cable)
731194-001	A	Solid-state drive, 256-GB, Self-encrypting drive (SED) (includes hard drive bracket and screws)
732626-001	N	Heat sink for use only on HP EliteBook 850 models with discrete graphics (includes replacement thermal material)
732678-001	A	Solid-state drive, 180-GB (includes hard drive bracket and screws)
732680-001	A	Solid-state drive, 240-GB (includes hard drive bracket and screws)
732681-001	A	Solid-state drive, 120-GB (includes hard drive bracket and screws)
733684-001	C	Raw display panel, (39.6-cm) 15.6-in LED, HD, AG, SVA (1368×768), 300 nits
733685-001	C	Raw display panel, (39.6-cm) 15.6-in LED, FHD, AG, SVA (1920×1080), 200 nits
736678-001	N	Antennas (WLAN, WWAN) for use only on HP EliteBook 750/850 models
737657-001	C	Raw display panel, (35.6-cm) 14.0-in LED, HD, AntiGlare (AG), SVA (1366×768), 200 nits
737658-001	C	Raw display panel, (35.6-cm) 14.0-in LED, HD+, AG, SVA (1920×1080), 250 nits
737659-001	C	Raw display panel, (35.6-cm) 14.0-in LED, FHD, AG, SVA (1920×1080), 300 nits
737660-001	N	Display Hinge Kit for use only on HP ZBook 14 models (includes left and right hinges and hinge covers)
737735-001	N	Display assembly, 14-inch, HD+, for use in HP EliteBook 740/840 models
739558-001	N	Plastics Kit for use only on HP ZBook 14 models (includes SD card insert, RJ-45 door, fingerprint reader insert, and RJ-45 spring)
739848-001	N	Display assembly, 14-inch, HD+, for use in HP ZBook 14 models

Spare part number	CSR flag	Description
742437-001	A	45-W HP Smart AC adapter (non-PFC, EM, 3-wire)
743008-001	A	Solid-state drive, 32-GB (includes hard drive bracket and screws)
744483-001	A	Solid-state drive, 128-GB (includes hard drive bracket and screws); for use only in HP EliteBook 15 models
745310-001	A	Service cover for use only on HP EliteBook 850 models; for RCTO
745311-001	A	Service cover for use only on HP EliteBook 840/HP ZBook 14 models; RCTO
747832-001	A	Intel Dual Band Wireless-N 7260AN 802.11 a/b/g/n 2x2 WiFi + BT4.0 (for use in Indonesia)
752240-001	A	Solid-state drive, 512-GB, (includes hard drive bracket and screws)
753361-001	A	Power cord, 1.8 m, 2-pin, for use in Japan
755530-001	A	Power cord for use in North America (3-pin, black, 1.83-m)
755530-011	A	Power cord for use in Australia (3-pin, black, 1.83-m)
755530-021	A	Power cord for use in Europe (3-pin, black, 1.83-m)
755530-031	A	Power cord for use in the United Kingdom and Singapore (3-pin, black, 1.83-m)
755530-061	A	Power cord for use in Italy (3-pin, black, 1.83-m)
755530-081	A	Power cord for use in Denmark (3-pin, black, 1.83-m)
755530-111	A	Power cord for use in Switzerland (3-pin, black, 1.83-m)
755530-201	A	Power cord for use in Thailand (3-pin, black, 1.83-m)
755530-202	A	Power cord for use in Brazil (3-pin, black, 1.83-m)
755530-291	A	Power cord for use in Japan (3-pin, black, 1.83-m)
755530-AA1	A	Power cord for use in the People's Republic of China (3-pin, black, 1.83-m)
755530-AB1	A	Power cord for use in Taiwan (3-pin, black, 1.83-m)
755530-AD1	A	Power cord for use in South Korea (3-pin, black, 1.83-m)
755530-AR1	A	Power cord for use in South Africa (3-pin, black, 1.83-m)
755530-BB1	A	Power cord for use in Israel (3-pin, black, 1.83-m)
755530-D01	A	Power cord for use in Argentina (3-pin, black, 1.83-m)
755530-D61	A	Power cord for use in India (3-pin, black, 1.83-m)
762689-001	A	Power cord, 1.0 m, 2-pin, for use in Japan
763529-001	A	1-TB, 5400-rpm hard drive, locked (does not include hard drive bracket or screws)
765809-001	N	Base enclosure for use only on HP EliteBook 740/840 models (includes RJ-45 door with spring)
765810-001	N	Base enclosure for use only on HP ZBook 14 models
765811-001	N	Base enclosure for use only on HP EliteBook 750/850 models (includes RJ-45 door with spring)
766013-001	A	256-GB, Self-encrypting drive (SED), OPAL
766324-001	A	Service cover for use only on HP EliteBook 840 models with a touch screen
766327-001	A	Service cover for use only on HP EliteBook 850 models with a touch screen

Spare part number	CSR flag	Description
766643-001	A	Solid-state drive, 256-GB (includes hard drive bracket and screws)
766644-001	A	Hard drive, 1-TB, 7200-rpm (for use in EliteBook 740/840 and ZBook 14 models)
766678-001	A	Solid-state drive, 128-GB, locked (for use only in HP EliteBook 740/840 and ZBook 14 models)
766680-001	N	Display assembly, 15-inch, HD, for use in HP EliteBook 750/850 models
773555-001	A	Hard drive, 500-GB, 5400-rpm, 7-mm, locked (SGT)(for use in EliteBook 740/840 and ZBook 14 models)
776476-001	A	1-TB, 5400-rpm hard drive, locked, for use in EliteBook 740/840 models (does not include hard drive bracket or screws)
776626-001	A	Hard drive, 500-GB, 5400-rpm, 7-mm, locked (SGT)(for use in EliteBook 740/840 and ZBook 14 models)
780090-001	A	256-GB, locked (for use only in HP EliteBook 740/840 and ZBook 14 models)
782123-001	A	Hard drive, 500-GB, 7200-rpm, 7-mm, locked (HGST)(for use in EliteBook 740/840 and ZBook 14 models)
784451-001	N	Display bezel for use in HP EliteBook 740 models
784452-001	A	Service cover for use only on HP EliteBook 740 models with a touch screen
784478-001	N	Display bezel for use in HP EliteBook 750 models
784479-001	A	Service cover for use only on HP EliteBook 750 models with a touch screen
786035-001	A	Solid-state drive, 120-GB, M.2 (for use only in HP EliteBook 750/850)
786173-001	A	Solid-state drive, 180-GB, Self-encrypting drive (includes hard drive bracket and screws)
789520-001	A	Hard drive, 320-GB, 5400-rpm, 7-mm, WD, locked (for use in EliteBook 740/840 and ZBook 14 models)
795941-001	A	Solid-state drive, 128-GB, locked, SanDisk
797431-001	N	Touchpad for use in EliteBook 750/850 models
797437-001	N	Touchpad for use in EliteBook 740/840 models
797438-001	N	Touchpad for use in ZBook 14 models
799300-001	A	Solid-state drive, 256-GB, Self-encrypting drive (SED), locked
800584-001	A	Solid-state drive, 256-GB, locked, SMSG
802511-001	N	System board with UMA graphics and an Intel Core i5-4300U processor for use in models without the Windows 8 operating system (Gold)
802511-0C1	N	System board with UMA graphics and an Intel Core i5-4300U processor for use in models without the Windows 8 operating system (Gold Conversion Kit)
802511-501	N	System board with UMA graphics and an Intel Core i5-4300U processor for use with the Windows 8 Standard operating system (Gold)
802511-5C1	N	System board with UMA graphics and an Intel Core i5-4300U processor for use with the Windows 8 Standard operating system (Gold Conversion Kit)
802511-601	N	System board with UMA graphics and an Intel Core i5-4300U processor for use with the Windows 8 Professional operating system (Gold)
802511-6C1	N	System board with UMA graphics and an Intel Core i5-4300U processor for use with the Windows 8 Professional operating system (Gold Conversion Kit)
802512-001	N	System board with discrete graphics and an Intel Core i5-4300U processor for use in EliteBook 740/840 and 750/850 models without the Windows 8 operating system (Gold)

Spare part number	CSR flag	Description
802512-0C1	N	System board with discrete graphics and an Intel Core i5-4300U processor for use in EliteBook 740/840 and 750/850 models without the Windows 8 operating system (Gold Conversion Kit)
802512-501	N	System board with discrete graphics and an Intel Core i5-4300U processor for use in EliteBook 740/840 and 750/850 models with the Windows 8 Standard operating system (Gold)
802512-5C1	N	System board with discrete graphics and an Intel Core i5-4300U processor for use in EliteBook 740/840 and 750/850 models with the Windows 8 Standard operating system (Gold Conversion Kit)
802512-601	N	System board with discrete graphics and an Intel Core i5-4300U processor for use in EliteBook 740/840 and 750/850 models with the Windows 8 Professional operating system (Gold)
802512-6C1	N	System board with discrete graphics and an Intel Core i5-4300U processor for use in EliteBook 740/840 and 750/850 models with the Windows 8 Professional operating system (Gold Conversion Kit)
802514-001	N	System board with UMA graphics and an Intel Core i3-4010U processor for use in EliteBook 740/840 and 750/850 models without the Windows 8 operating system (Gold)
802514-0C1	N	System board with UMA graphics and an Intel Core i3-4010U processor for use in EliteBook 740/840 and 750/850 models without the Windows 8 operating system (Gold Conversion Kit)
802514-501	N	System board with UMA graphics and an Intel Core i3-4010U processor for use in EliteBook 740/840 and 750/850 models with the Windows 8 Standard operating system (Gold)
802514-5C1	N	System board with UMA graphics and an Intel Core i3-4010U processor for use in EliteBook 740/840 and 750/850 models with the Windows 8 Standard operating system (Gold Conversion Kit)
802514-601	N	System board with UMA graphics and an Intel Core i3-4010U processor for use in EliteBook 740/840 and 750/850 models with the Windows 8 Professional operating system (Gold)
802514-6C1	N	System board with UMA graphics and an Intel Core i3-4010U processor for use in EliteBook 740/840 and 750/850 models with the Windows 8 Professional operating system (Gold Conversion Kit)
802515-001	N	System board with discrete graphics and an Intel Core i3-4010U processor for use in EliteBook 740/840 and 750/850 models without the Windows 8 operating system (Gold)
802515-0C1	N	System board with discrete graphics and an Intel Core i3-4010U processor for use in EliteBook 740/840 and 750/850 models without the Windows 8 operating system (Gold Conversion Kit)
802515-501	N	System board with discrete graphics and an Intel Core i3-4010U processor for use in EliteBook 740/840 and 750/850 models with the Windows 8 Standard operating system (Gold)
802515-5C1	N	System board with discrete graphics and an Intel Core i3-4010U processor for use in EliteBook 740/840 and 750/850 models with the Windows 8 Standard operating system (Gold Conversion Kit)
802515-601	N	System board with discrete graphics and an Intel Core i3-4010U processor for use in EliteBook 740/840 and 750/850 models with the Windows 8 Professional operating system (Gold)
802515-6C1	N	System board with discrete graphics and an Intel Core i3-4010U processor for use in EliteBook 740/840 and 750/850 models with the Windows 8 Professional operating system (Gold Conversion Kit)
802516-001	N	System board with UMA graphics and an Intel Core i5-4200U processor for use in models without the Windows 8 operating system (Gold)
802516-0C1	N	System board with UMA graphics and an Intel Core i5-4200U processor for use in models without the Windows 8 operating system (Gold Conversion Kit)
802516-501	N	System board with UMA graphics and an Intel Core i5-4200U processor for use with the Windows 8 Standard operating system (Gold)
802516-5C1	N	System board with UMA graphics and an Intel Core i5-4200U processor for use with the Windows 8 Standard operating system (Gold Conversion Kit)
802516-601	N	System board with UMA graphics and an Intel Core i5-4200U processor for use with the Windows 8 Professional operating system (Gold)

Spare part number	CSR flag	Description
802516-6C1	N	System board with UMA graphics and an Intel Core i5-4200U processor for use with the Windows 8 Professional operating system (Gold Conversion Kit)
802517-001	N	System board with discrete graphics and an Intel Core i5-4200U processor for use in EliteBook 740/840 and 750/850 models without the Windows 8 operating system (Gold)
802517-0C1	N	System board with discrete graphics and an Intel Core i5-4200U processor for use in EliteBook 740/840 and 750/850 models without the Windows 8 operating system (Gold Conversion Kit)
802517-501	N	System board with discrete graphics and an Intel Core i5-4200U processor for use in EliteBook 740/840 and 750/850 models with the Windows 8 Standard operating system (Gold)
802517-5C1	N	System board with discrete graphics and an Intel Core i5-4200U processor for use in EliteBook 740/840 and 750/850 models with the Windows 8 Standard operating system (Gold Conversion Kit)
802517-601	N	System board with discrete graphics and an Intel Core i5-4200U processor for use in EliteBook 740/840 and 750/850 models with the Windows 8 Professional operating system (Gold)
802517-6C1	N	System board with discrete graphics and an Intel Core i5-4200U processor for use in EliteBook 740/840 and 750/850 models with the Windows 8 Professional operating system (Gold Conversion Kit)
802518-001	N	System board with UMA graphics and an Intel Core i7-4600U processor for use in models without the Windows 8 operating system (Gold)
802518-0C1	N	System board with UMA graphics and an Intel Core i7-4600U processor for use in models without the Windows 8 operating system (Gold Conversion Kit)
802518-501	N	System board with UMA graphics and an Intel Core i7-4600U processor for use in models with the Windows 8 Standard operating system (Gold)
802518-5C1	N	System board with UMA graphics and an Intel Core i7-4600U processor for use in models with the Windows 8 Standard operating system (Gold Conversion Kit)
802518-601	N	System board with UMA graphics and an Intel Core i7-4600U processor for use in models with the Windows 8 Professional operating system (Gold)
802518-6C1	N	System board with UMA graphics and an Intel Core i7-4600U processor for use in models with the Windows 8 Professional operating system (Gold Conversion Kit)
802519-001	N	System board with discrete graphics and an Intel Core i7-4600U processor for use in EliteBook 750/850 models without the Windows 8 operating system (Gold)
802519-0C1	N	System board with discrete graphics and an Intel Core i7-4600U processor for use in EliteBook 750/850 models without the Windows 8 operating system (Gold Conversion Kit)
802519-501	N	System board with discrete graphics and an Intel Core i7-4600U processor for use in EliteBook 750/850 models with the Windows 8 Standard operating system (Gold)
802519-5C1	N	System board with discrete graphics and an Intel Core i7-4600U processor for use in EliteBook 750/850 models with the Windows 8 Standard operating system (Gold Conversion Kit)
802519-601	N	System board with discrete graphics and an Intel Core i7-4600U processor for use in EliteBook 750/850 models with the Windows 8 Professional operating system (Gold)
802519-6C1	N	System board with discrete graphics and an Intel Core i7-4600U processor for use in EliteBook 750/850 models with the Windows 8 Professional operating system (Gold Conversion Kit)
802520-001	N	System board with discrete graphics and an Intel Core i5-4200U processor for use in ZBook 14 models without the Windows 8 operating system (Gold)
802520-0C1	N	System board with discrete graphics and an Intel Core i5-4200U processor for use in ZBook 14 models without the Windows 8 operating system (Gold Conversion Kit)
802520-501	N	System board with discrete graphics and an Intel Core i5-4200U processor for use in ZBook 14 models with the Windows 8 Standard operating system (Gold)

Spare part number	CSR flag	Description
802520-5C1	N	System board with discrete graphics and an Intel Core i5-4200U processor for use in ZBook 14 models with the Windows 8 Standard operating system (Gold Conversion Kit)
802520-601	N	System board with discrete graphics and an Intel Core i5-4200U processor for use in ZBook 14 models with the Windows 8 Professional operating system (Gold)
802520-6C1	N	System board with discrete graphics and an Intel Core i5-4200U processor for use in ZBook 14 models with the Windows 8 Professional operating system (Gold Conversion Kit)
802521-001	N	System board with discrete graphics and an Intel Core i5-4300U processor for use in ZBook 14 models without the Windows 8 operating system (Gold)
802521-0C1	N	System board with discrete graphics and an Intel Core i5-4300U processor for use in ZBook 14 models without the Windows 8 operating system (Gold Conversion Kit)
802521-501	N	System board with discrete graphics and an Intel Core i5-4300U processor for use in ZBook 14 models with the Windows 8 Standard operating system (Gold)
802521-5C1	N	System board with discrete graphics and an Intel Core i5-4300U processor for use in ZBook 14 models with the Windows 8 Standard operating system (Gold Conversion Kit)
802521-601	N	System board with discrete graphics and an Intel Core i5-4300U processor for use in ZBook 14 models with the Windows 8 Professional operating system (Gold)
802521-6C1	N	System board with discrete graphics and an Intel Core i5-4300U processor for use in ZBook 14 models with the Windows 8 Professional operating system (Gold Conversion Kit)
802522-001	N	System board with discrete graphics and an Intel Core i7-4600U processor for use in ZBook 14 models without the Windows 8 operating system (Gold)
802522-0C1	N	System board with discrete graphics and an Intel Core i7-4600U processor for use in ZBook 14 models without the Windows 8 operating system (Gold Conversion Kit)
802522-501	N	System board with discrete graphics and an Intel Core i7-4600U processor for use in ZBook 14 models with the Windows 8 Standard operating system (Gold)
802522-5C1	N	System board with discrete graphics and an Intel Core i7-4600U processor for use in ZBook 14 models with the Windows 8 Standard operating system (Gold Conversion Kit)
802522-601	N	System board with discrete graphics and an Intel Core i7-4600U processor for use in ZBook 14 models with the Windows 8 Professional operating system (Gold)
802522-6C1	N	System board with discrete graphics and an Intel Core i7-4600U processor for use in ZBook 14 models with the Windows 8 Professional operating system (Gold Conversion Kit)
802523-001	N	System board with UMA graphics and an Intel Core i7-4500U processor for use in models without the Windows 8 operating system (Gold)
802523-0C1	N	System board with UMA graphics and an Intel Core i7-4500U processor for use in models without the Windows 8 operating system (Gold Conversion Kit)
802523-501	N	System board with discrete graphics and an Intel Core i7-4500U processor for use in models with the Windows 8 Standard operating system (Gold)
802523-5C1	N	System board with discrete graphics and an Intel Core i7-4500U processor for use in models with the Windows 8 Standard operating system (Gold Conversion Kit)
802523-601	N	System board with discrete graphics and an Intel Core i7-4500U processor for use in models with the Windows 8 Professional operating system (Gold)
802523-6C1	N	System board with discrete graphics and an Intel Core i7-4500U processor for use in models with the Windows 8 Professional operating system (Gold Conversion Kit)
802524-001	N	System board with discrete graphics and an Intel Core i7-4500U processor for use in EliteBook 740/840 and 750/850 models without the Windows 8 operating system (Gold)

Spare part number	CSR flag	Description
802524-0C1	N	System board with discrete graphics and an Intel Core i7-4500U processor for use in EliteBook 740/840 and 750/850 models without the Windows 8 operating system (Gold Conversion Kit)
802524-501	N	System board with discrete graphics and an Intel Core i7-4500U processor for use in EliteBook 740/840 and 750/850 models with the Windows 8 Standard operating system (Gold)
802524-5C1	N	System board with discrete graphics and an Intel Core i7-4500U processor for use in EliteBook 740/840 and 750/850 models with the Windows 8 Standard operating system (Gold Conversion Kit)
802524-601	N	System board with discrete graphics and an Intel Core i7-4500U processor for use in EliteBook 740/840 and 750/850 models with the Windows 8 Professional operating system (Gold)
802524-6C1	N	System board with discrete graphics and an Intel Core i7-4500U processor for use in EliteBook 740/840 and 750/850 models with the Windows 8 Professional operating system (Gold Conversion Kit)
802525-001	N	System board with discrete graphics and an Intel Core i7-4500U processor for use in ZBook 14 models without the Windows 8 operating system (Gold)
802525-0C1	N	System board with discrete graphics and an Intel Core i7-4500U processor for use in ZBook 14 models without the Windows 8 operating system (Gold Conversion Kit)
802525-501	N	System board with discrete graphics and an Intel Core i7-4500U processor for use in ZBook 14 models with the Windows 8 Standard operating system (Gold)
802525-5C1	N	System board with discrete graphics and an Intel Core i7-4500U processor for use in ZBook 14 models with the Windows 8 Standard operating system (Gold Conversion Kit)
802525-601	N	System board with discrete graphics and an Intel Core i7-4500U processor for use in ZBook 14 models with the Windows 8 Professional operating system (Gold)
802525-6C1	N	System board with discrete graphics and an Intel Core i7-4500U processor for use in ZBook 14 models with the Windows 8 Professional operating system (Gold Conversion Kit)
802526-001	N	System board with discrete graphics and an Intel Core i5-4210U processor for use in ZBook 14 models without the Windows 8 operating system (Gold)
802526-0C1	N	System board with discrete graphics and an Intel Core i5-4210U processor for use in ZBook 14 models without the Windows 8 operating system (Gold Conversion Kit)
802526-501	N	System board with discrete graphics and an Intel Core i5-4210U processor for use in ZBook 14 models with the Windows 8 Standard operating system (Gold)
802526-5C1	N	System board with discrete graphics and an Intel Core i5-4210U processor for use in ZBook 14 models with the Windows 8 Standard operating system (Gold Conversion Kit)
802526-601	N	System board with discrete graphics and an Intel Core i5-4210U processor for use in ZBook 14 models with the Windows 8 Professional operating system (Gold)
802526-6C1	N	System board with discrete graphics and an Intel Core i5-4210U processor for use in ZBook 14 models with the Windows 8 Professional operating system (Gold Conversion Kit)
802527-001	N	System board with discrete graphics and an Intel Core i5-4310U processor for use in ZBook 14 models without the Windows 8 operating system (Gold)
802527-0C1	N	System board with discrete graphics and an Intel Core i5-4310U processor for use in ZBook 14 models without the Windows 8 operating system (Gold Conversion Kit)
802527-501	N	System board with discrete graphics and an Intel Core i5-4310U processor for use in ZBook 14 models with the Windows 8 Standard operating system (Gold)
802527-5C1	N	System board with discrete graphics and an Intel Core i5-4310U processor for use in ZBook 14 models with the Windows 8 Standard operating system (Gold Conversion Kit)
802527-601	N	System board with discrete graphics and an Intel Core i5-4310U processor for use in ZBook 14 models with the Windows 8 Professional operating system (Gold)

Spare part number	CSR flag	Description
802527-6C1	N	System board with discrete graphics and an Intel Core i5-4310U processor for use in ZBook 14 models with the Windows 8 Professional operating system (Gold Conversion Kit)
802528-001	N	System board with discrete graphics and an Intel Core i7-4510U processor for use in ZBook 14 models without the Windows 8 operating system (Gold)
802528-0C1	N	System board with discrete graphics and an Intel Core i7-4510U processor for use in ZBook 14 models without the Windows 8 operating system (Gold Conversion Kit)
802528-501	N	System board with discrete graphics and an Intel Core i7-4510U processor for use in ZBook 14 models with the Windows 8 Standard operating system (Gold)
802528-5C1	N	System board with discrete graphics and an Intel Core i7-4510U processor for use in ZBook 14 models with the Windows 8 Standard operating system (Gold Conversion Kit)
802528-601	N	System board with discrete graphics and an Intel Core i7-4510U processor for use in ZBook 14 models with the Windows 8 Professional operating system (Gold)
802528-6C1	N	System board with discrete graphics and an Intel Core i7-4510U processor for use in ZBook 14 models with the Windows 8 Professional operating system (Gold Conversion Kit)
802529-001	N	System board with UMA graphics and an Intel Core i3-4030U processor for use in models without the Windows 8 operating system (Gold)
802529-0C1	N	System board with UMA graphics and an Intel Core i3-4030U processor for use in models without the Windows 8 operating system (Gold Conversion Kit)
802529-501	N	System board with UMA graphics and an Intel Core i3-4030U processor for use in models with the Windows 8 Standard operating system (Gold)
802529-5C1	N	System board with UMA graphics and an Intel Core i3-4030U processor for use in models with the Windows 8 Standard operating system (Gold Conversion Kit)
802529-601	N	System board with UMA graphics and an Intel Core i3-4030U processor for use in models with the Windows 8 Professional operating system (Gold)
802529-6C1	N	System board with UMA graphics and an Intel Core i3-4030U processor for use in models with the Windows 8 Professional operating system (Gold Conversion Kit)
802530-001	N	System board with discrete graphics and an Intel Core i3-4030U processor for use in EliteBook 740/840 and 750/850 models without the Windows 8 operating system (Gold)
802530-0C1	N	System board with discrete graphics and an Intel Core i3-4030U processor for use in EliteBook 740/840 and 750/850 models without the Windows 8 operating system (Gold Conversion Kit)
802530-501	N	System board with discrete graphics and an Intel Core i3-4030U processor for use in EliteBook 740/840 and 750/850 models with the Windows 8 Standard operating system (Gold)
802530-5C1	N	System board with discrete graphics and an Intel Core i3-4030U processor for use in EliteBook 740/840 and 750/850 models with the Windows 8 Standard operating system (Gold Conversion Kit)
802530-601	N	System board with discrete graphics and an Intel Core i3-4030U processor for use in EliteBook 740/840 and 750/850 models with the Windows 8 Professional operating system (Gold)
802530-6C1	N	System board with discrete graphics and an Intel Core i3-4030U processor for use in EliteBook 740/840 and 750/850 models with the Windows 8 Professional operating system (Gold Conversion Kit)
802531-001	N	System board with UMA graphics and an Intel Core i5-4210U processor for use in models without the Windows 8 operating system (Gold)
802531-0C1	N	System board with UMA graphics and an Intel Core i5-4210U processor for use in models without the Windows 8 operating system (Gold Conversion Kit)
802531-501	N	System board with UMA graphics and an Intel Core i5-4210U processor for use in models with the Windows 8 Standard operating system (Gold)

Spare part number	CSR flag	Description
802531-5C1	N	System board with UMA graphics and an Intel Core i5-4210U processor for use in models with the Windows 8 Standard operating system (Gold Conversion Kit)
802531-601	N	System board with UMA graphics and an Intel Core i5-4210U processor for use in models with the Windows 8 Professional operating system (Gold)
802531-6C1	N	System board with UMA graphics and an Intel Core i5-4210U processor for use in models with the Windows 8 Professional operating system (Gold Conversion Kit)
802532-001	N	System board with discrete graphics and an Intel Core i5-4210U processor for use in EliteBook 740/840 and 750/850 models without the Windows 8 operating system (Gold)
802532-0C1	N	System board with discrete graphics and an Intel Core i5-4210U processor for use in EliteBook 740/840 and 750/850 models without the Windows 8 operating system (Gold Conversion Kit)
802532-501	N	System board with discrete graphics and an Intel Core i5-4210U processor for use in EliteBook 740/840 and 750/850 models with the Windows 8 Standard operating system (Gold)
802532-5C1	N	System board with discrete graphics and an Intel Core i5-4210U processor for use in EliteBook 740/840 and 750/850 models with the Windows 8 Standard operating system (Gold Conversion Kit)
802532-601	N	System board with discrete graphics and an Intel Core i5-4210U processor for use in EliteBook 740/840 and 750/850 models with the Windows 8 Professional operating system (Gold)
802532-6C1	N	System board with discrete graphics and an Intel Core i5-4210U processor for use in EliteBook 740/840 and 750/850 models with the Windows 8 Professional operating system (Gold Conversion Kit)
802533-001	N	System board with UMA graphics and an Intel Core i5-4310U processor for use in models without the Windows 8 operating system (Gold)
802533-0C1	N	System board with UMA graphics and an Intel Core i5-4310U processor for use in models without the Windows 8 operating system (Gold Conversion Kit)
802533-501	N	System board with UMA graphics and an Intel Core i5-4310U processor for use in models with the Windows 8 Standard operating system (Gold)
802533-5C1	N	System board with UMA graphics and an Intel Core i5-4310U processor for use in models with the Windows 8 Standard operating system (Gold Conversion Kit)
802533-601	N	System board with UMA graphics and an Intel Core i5-4310U processor for use in models with the Windows 8 Professional operating system (Gold)
802533-6C1	N	System board with UMA graphics and an Intel Core i5-4310U processor for use in models with the Windows 8 Professional operating system (Gold Conversion Kit)
802534-001	N	System board with discrete graphics and an Intel Core i5-4310U processor for use in EliteBook 740/840 and 750/850 models without the Windows 8 operating system (Gold)
802534-0C1	N	System board with discrete graphics and an Intel Core i5-4310U processor for use in EliteBook 740/840 and 750/850 models without the Windows 8 operating system (Gold Conversion Kit)
802534-501	N	System board with discrete graphics and an Intel Core i5-4310U processor for use in EliteBook 740/840 and 750/850 models with the Windows 8 Standard operating system (Gold)
802534-5C1	N	System board with discrete graphics and an Intel Core i5-4310U processor for use in EliteBook 740/840 and 750/850 models with the Windows 8 Standard operating system (Gold Conversion Kit)
802534-601	N	System board with discrete graphics and an Intel Core i5-4310U processor for use in EliteBook 740/840 and 750/850 models with the Windows 8 Professional operating system (Gold)
802534-6C1	N	System board with discrete graphics and an Intel Core i5-4310U processor for use in EliteBook 740/840 and 750/850 models with the Windows 8 Professional operating system (Gold Conversion Kit)
802535-001	N	System board with UMA graphics and an Intel Core i5-4510U processor for use in EliteBook 750/850 models without the Windows 8 operating system (Gold)

Spare part number	CSR flag	Description
802535-0C1	N	System board with UMA graphics and an Intel Core i5-4510U processor for use in EliteBook 750/850 models without the Windows 8 operating system (Gold Conversion Kit)
802535-501	N	System board with UMA graphics and an Intel Core i5-4510U processor for use in EliteBook 750/850 models with the Windows 8 Standard operating system (Gold)
802535-5C1	N	System board with UMA graphics and an Intel Core i5-4510U processor for use in EliteBook 750/850 models with the Windows 8 Standard operating system (Gold Conversion Kit)
802535-601	N	System board with UMA graphics and an Intel Core i5-4510U processor for use in EliteBook 750/850 models with the Windows 8 Professional operating system (Gold)
802535-6C1	N	System board with UMA graphics and an Intel Core i5-4510U processor for use in EliteBook 750/850 models with the Windows 8 Professional operating system (Gold Conversion Kit)
802536-001	N	System board with discrete graphics and an Intel Core i5-4510U processor for use in EliteBook 740/840 and 750/850 models without the Windows 8 operating system (Gold)
802536-0C1	N	System board with discrete graphics and an Intel Core i5-4510U processor for use in EliteBook 740/840 and 750/850 models without the Windows 8 operating system (Gold Conversion Kit)
802536-501	N	System board with discrete graphics and an Intel Core i5-4510U processor for use in EliteBook 740/840 and 750/850 models with the Windows 8 Standard operating system (Gold)
802536-5C1	N	System board with discrete graphics and an Intel Core i5-4510U processor for use in EliteBook 740/840 and 750/850 models with the Windows 8 Standard operating system (Gold Conversion Kit)
802536-601	N	System board with discrete graphics and an Intel Core i5-4510U processor for use in EliteBook 740/840 and 750/850 models with the Windows 8 Professional operating system (Gold)
802536-6C1	N	System board with discrete graphics and an Intel Core i5-4510U processor for use in EliteBook 740/840 and 750/850 models with the Windows 8 Professional operating system (Gold Conversion Kit)

4 Removal and replacement procedures preliminary requirements

Tools required

You will need the following tools to complete the removal and replacement procedures:

- Flat-bladed screwdriver
- Magnetic screwdriver
- Phillips P0 and P1 screwdrivers

Service considerations

The following sections include some of the considerations that you must keep in mind during disassembly and assembly procedures.

 **NOTE:** As you remove each subassembly from the computer, place the subassembly (and all accompanying screws) away from the work area to prevent damage.

Plastic parts

 **CAUTION:** Using excessive force during disassembly and reassembly can damage plastic parts. Use care when handling the plastic parts. Apply pressure only at the points designated in the maintenance instructions.

Cables and connectors

 **CAUTION:** When servicing the computer, be sure that cables are placed in their proper locations during the reassembly process. Improper cable placement can damage the computer.

Cables must be handled with extreme care to avoid damage. Apply only the tension required to unseat or seat the cables during removal and insertion. Handle cables by the connector whenever possible. In all cases, avoid bending, twisting, or tearing cables. Be sure that cables are routed in such a way that they cannot be caught or snagged by parts being removed or replaced. Handle flex cables with extreme care; these cables tear easily.

Drive handling

⚠ CAUTION: Drives are fragile components that must be handled with care. To prevent damage to the computer, damage to a drive, or loss of information, observe these precautions:

Before removing or inserting a hard drive, shut down the computer. If you are unsure whether the computer is off or in Hibernation, turn the computer on, and then shut it down through the operating system.

Before handling a drive, be sure that you are discharged of static electricity. While handling a drive, avoid touching the connector.

Before removing a diskette drive or optical drive, be sure that a diskette or disc is not in the drive and be sure that the optical drive tray is closed.

Handle drives on surfaces covered with at least one inch of shock-proof foam.

Avoid dropping drives from any height onto any surface.

After removing a hard drive, an optical drive, or a diskette drive, place it in a static-proof bag.

Avoid exposing an internal hard drive to products that have magnetic fields, such as monitors or speakers.

Avoid exposing a drive to temperature extremes or liquids.

If a drive must be mailed, place the drive in a bubble pack mailer or other suitable form of protective packaging and label the package “FRAGILE.”

Grounding guidelines

Electrostatic discharge damage

Electronic components are sensitive to electrostatic discharge (ESD). Circuitry design and structure determine the degree of sensitivity. Networks built into many integrated circuits provide some protection, but in many cases, ESD contains enough power to alter device parameters or melt silicon junctions.

A discharge of static electricity from a finger or other conductor can destroy static-sensitive devices or microcircuitry. Even if the spark is neither felt nor heard, damage may have occurred.

An electronic device exposed to ESD may not be affected at all and can work perfectly throughout a normal cycle. Or the device may function normally for a while, then degrade in the internal layers, reducing its life expectancy.

⚠ CAUTION: To prevent damage to the computer when you are removing or installing internal components, observe these precautions:

Keep components in their electrostatic-safe containers until you are ready to install them.

Before touching an electronic component, discharge static electricity by using the guidelines described in this section.

Avoid touching pins, leads, and circuitry. Handle electronic components as little as possible.

If you remove a component, place it in an electrostatic-safe container.

The following table shows how humidity affects the electrostatic voltage levels generated by different activities.

⚠ CAUTION: A product can be degraded by as little as 700 V.

Typical electrostatic voltage levels			
Event	Relative humidity		
	10%	40%	55%
Walking across carpet	35,000 V	15,000 V	7,500 V
Walking across vinyl floor	12,000 V	5,000 V	3,000 V
Motions of bench worker	6,000 V	800 V	400 V
Removing DIPS from plastic tube	2,000 V	700 V	400 V
Removing DIPS from vinyl tray	11,500 V	4,000 V	2,000 V
Removing DIPS from Styrofoam	14,500 V	5,000 V	3,500 V
Removing bubble pack from PCB	26,500 V	20,000 V	7,000 V
Packing PCBs in foam-lined box	21,000 V	11,000 V	5,000 V

Packaging and transporting guidelines

Follow these grounding guidelines when packaging and transporting equipment:

- To avoid hand contact, transport products in static-safe tubes, bags, or boxes.
- Protect ESD-sensitive parts and assemblies with conductive or approved containers or packaging.
- Keep ESD-sensitive parts in their containers until the parts arrive at static-free workstations.
- Place items on a grounded surface before removing items from their containers.
- Always be properly grounded when touching a component or assembly.
- Store reusable ESD-sensitive parts from assemblies in protective packaging or nonconductive foam.
- Use transporters and conveyors made of antistatic belts and roller bushings. Be sure that mechanized equipment used for moving materials is wired to ground and that proper materials are selected to avoid static charging. When grounding is not possible, use an ionizer to dissipate electric charges.

Workstation guidelines

Follow these grounding workstation guidelines:

- Cover the workstation with approved static-shielding material.
- Use a wrist strap connected to a properly grounded work surface and use properly grounded tools and equipment.
- Use conductive field service tools, such as cutters, screwdrivers, and vacuums.
- When fixtures must directly contact dissipative surfaces, use fixtures made only of static-safe materials.
- Keep the work area free of nonconductive materials, such as ordinary plastic assembly aids and Styrofoam.
- Handle ESD-sensitive components, parts, and assemblies by the case or PCM laminate. Handle these items only at static-free workstations.

- Avoid contact with pins, leads, or circuitry.
- Turn off power and input signals before inserting or removing connectors or test equipment.

Equipment guidelines

Grounding equipment must include either a wrist strap or a foot strap at a grounded workstation.

- When seated, wear a wrist strap connected to a grounded system. Wrist straps are flexible straps with a minimum of one megohm $\pm 10\%$ resistance in the ground cords. To provide proper ground, wear a strap snugly against the skin at all times. On grounded mats with banana-plug connectors, use alligator clips to connect a wrist strap.
- When standing, use foot straps and a grounded floor mat. Foot straps (heel, toe, or boot straps) can be used at standing workstations and are compatible with most types of shoes or boots. On conductive floors or dissipative floor mats, use foot straps on both feet with a minimum of one megohm resistance between the operator and ground. To be effective, the conductive must be worn in contact with the skin.

The following grounding equipment is recommended to prevent electrostatic damage:

- Antistatic tape
- Antistatic smocks, aprons, and sleeve protectors
- Conductive bins and other assembly or soldering aids
- Nonconductive foam
- Conductive tabletop workstations with ground cords of one megohm resistance
- Static-dissipative tables or floor mats with hard ties to the ground
- Field service kits
- Static awareness labels
- Material-handling packages
- Nonconductive plastic bags, tubes, or boxes
- Metal tote boxes
- Electrostatic voltage levels and protective materials

The following table lists the shielding protection provided by antistatic bags and floor mats.

Material	Use	Voltage protection level
Antistatic plastics	Bags	1,500 V
Carbon-loaded plastic	Floor mats	7,500 V
Metallized laminate	Floor mats	5,000 V

5 Removal and replacement procedures for Customer Self-Repair parts

 **CAUTION:** The Customer Self-Repair program is not available in all locations. Installing a part not supported by the Customer Self-Repair program may void your warranty. Check your warranty to determine if Customer Self-Repair is supported in your location.

Component replacement procedures

This chapter provides removal and replacement procedures.

There are as many as 15 screws that must be removed, replaced, and/or loosened when servicing the Customer Self-Repair parts. Make special note of each screw size and location during removal and replacement.

Service cover

Description	Spare part number
Service cover for use only on HP EliteBook 840 models with a touch screen	766324-001
Service cover for use only on HP EliteBook 740 models with a touch screen	784452-001
Service cover for use only on HP EliteBook 840/HP ZBook 14 models; RCTO	745311-001
Service cover for use only on HP ZBook 14 models	730961-001
Service cover for use only on HP EliteBook 850 models with a touch screen	766327-001
Service cover for use only on HP EliteBook 750 models with a touch screen	784479-001
Service cover for use only on HP EliteBook 850 models; RCTO	745310-001

Before removing the service cover, follow these steps:

1. Turn off the computer. If you are unsure whether the computer is off or in Hibernation, turn the computer on, and then shut it down through the operating system.
2. Disconnect the power from the computer by unplugging the power cord from the computer.
3. Disconnect all external devices from the computer.

Remove the service cover:

1. Slide the service cover release latch **(1)**, remove the screw (if the optional screw is being used) **(2)**, and then slide the release latch again **(3)** to release the service cover.



NOTE: If you do not want to use the optional screw, you can store it inside the service cover.

2. Slide the service cover toward the front of the computer **(4)** and lift **(5)** to remove the service cover.

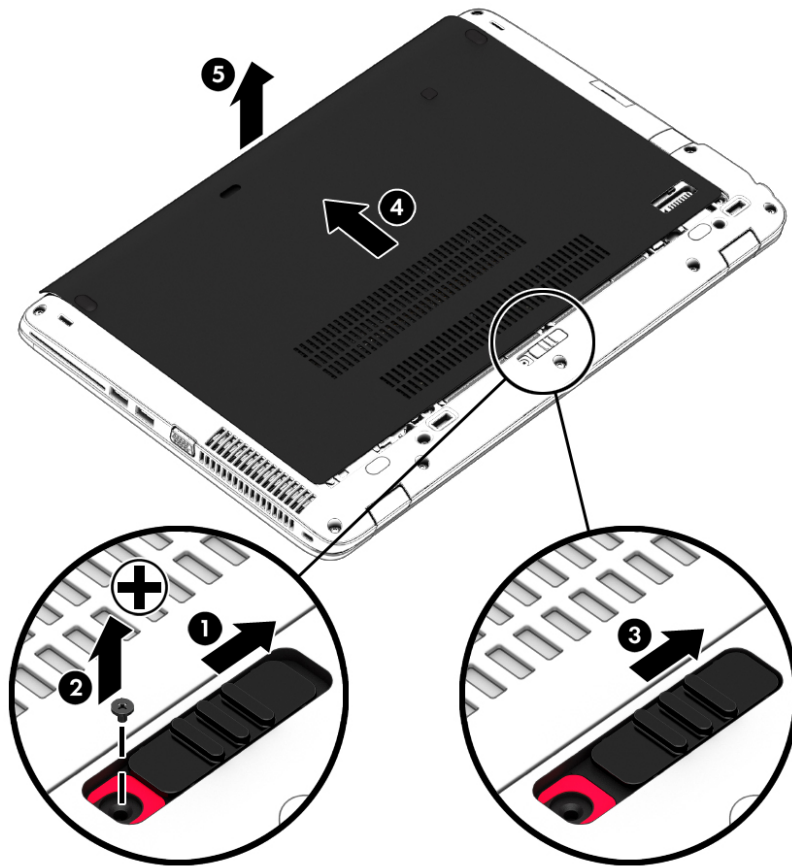

Reverse the removal procedures to install the service cover.

Battery

Description	Spare part number
6-cell, 60-Wh, 2.7-Ah (for use in EliteBook 740/840 and ZBook 14 models)	719796-001
3-cell, 50-Wh, 4.5-Ah	717376-001
3-cell, 24-Wh, 2.4-Ah	717375-001

Before disassembling the computer, follow these steps:

1. Turn off the computer. If you are unsure whether the computer is off or in Hibernation, turn the computer on, and then shut it down through the operating system.
2. Disconnect the power from the computer by unplugging the power cord from the computer.
3. Disconnect all external devices from the computer.
4. Remove the service cover (see [Service cover on page 57](#)).

Remove the battery:

1. Slide the battery release latches **(1)**, and then lift the battery **(2)**.
2. Remove the battery from the computer **(3)**.

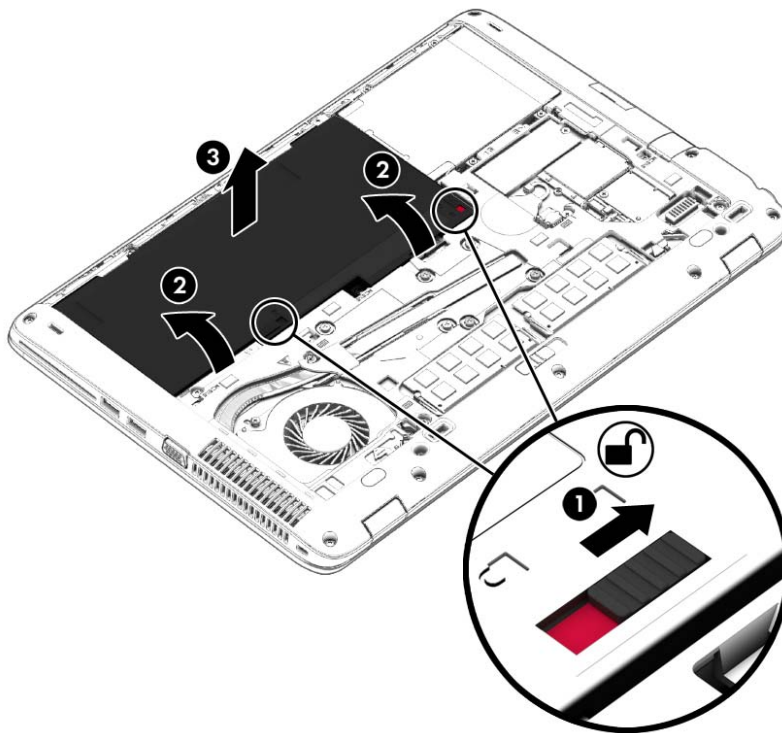

Install the battery by inserting it into the battery bay until you hear a click.

Hard drive



NOTE: The hard drive spare part kit does not include the hard drive bracket or screws.

Description	Spare part number
1-TB, 7200-rpm (for use in EliteBook 740/840 and ZBook 14 models)	766644-001
1-TB, 5400-rpm, 2.5-inch	676521-001
1-TB, 5400-rpm hard drive, locked, for use in EliteBook 740/840 models (does not include hard drive bracket or screws)	776476-001
1-TB, 5400-rpm, locked	763529-001
750-GB, 7200-rpm, 2.5-inch (for use in EliteBook 740/840 and ZBook 14 models)	633252-001
500-GB, 7200-rpm, 7-mm, SED	703268-001
500-GB, 7200-rpm, 2.5-inch, SED	683801-001
500-GB, 7200-rpm, 7-mm	703267-001
500-GB, 7200-rpm, 7-mm, locked (HGST)(for use in EliteBook 740/840 and ZBook 14 models)	782123-001
500-GB, 5400-rpm, 7-mm	683802-001
500-GB, 5400-rpm, 7-mm, FIPS	730946-001
500-GB, 5400-rpm, 7-mm, locked (SGT)(for use in EliteBook 740/840 and ZBook 14 models)	773555-001
500-GB, 5400-rpm, 7-mm, locked (SGT)(for use in EliteBook 740/840 and ZBook 14 models)	776626-001
320-GB, 5400-rpm, 7-mm	634862-001
320-GB, 5400-rpm, 7-mm, WD, locked (for use in EliteBook 740/840 and ZBook 14 models)	789520-001
Hard Drive Hardware Kit (includes hard drive bracket and screws)	730793-001

Before removing the hard drive, follow these steps:

1. Turn off the computer. If you are unsure whether the computer is off or in Hibernation, turn the computer on, and then shut it down through the operating system.
2. Disconnect the power from the computer by unplugging the power cord from the computer.
3. Disconnect all external devices from the computer.
4. Remove the service cover (see [Service cover on page 57](#)).
5. Disconnect the battery.

Remove the hard drive:

1. Turn the computer upside down on a flat surface.

2. Loosen the 4 hard drive screws (1). Slide the hard drive (2) forward, and then remove it (3).

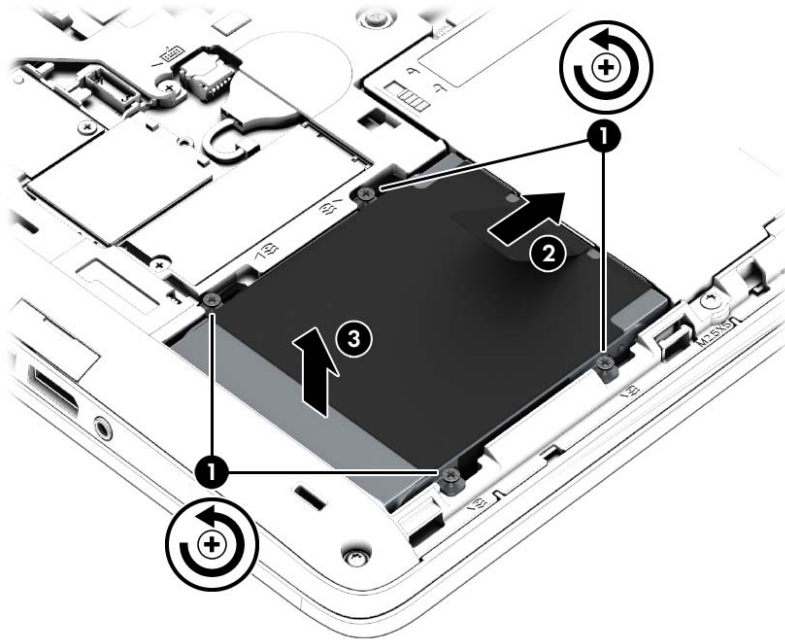

3. If it is necessary to disassemble the hard drive, perform the following steps:
- Remove the four Phillips PM3.0×3.0 screws (1) that secure the hard drive bracket to the hard drive.
 - Slide the hard drive bracket (2) off the hard drive. The hard drive bracket and screws are available in the Hard Drive Hardware Kit, spare part number 730793-001.

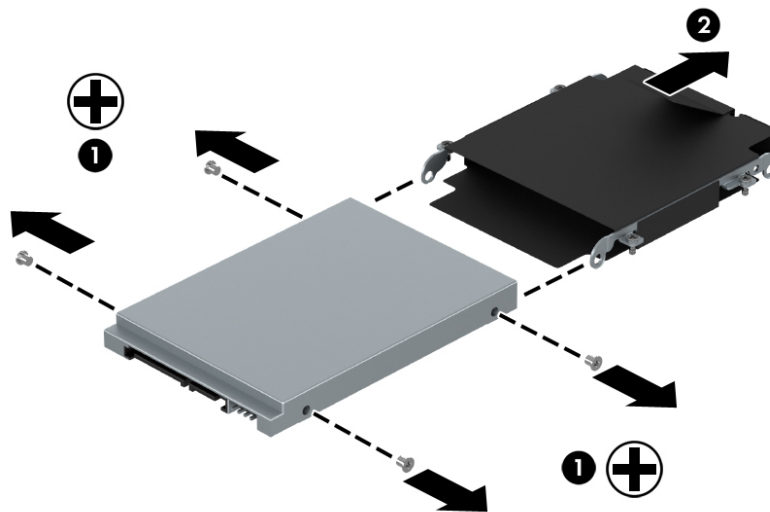

Reverse this procedure to reassemble and install the hard drive.

Solid-state drive (SSD)

Description	Spare part number
512-GB	752240-001
256-GB, Self-encrypting drive (SED), SSD	731194-001
256-GB, Self-encrypting drive (SED), OPAL	766013-001
256-GB	766643-001
256-GB, locked (for use only in HP EliteBook 740/840 and ZBook 14 models)	780090-001
256-GB, Self-encrypting drive (SED), locked	799300-001
256-GB, locked, SMSG	800584-001
240-GB	732680-001
180-GB	732678-001
180-GB, Self-encrypting drive (SED)	786173-001
128-GB, SSD (for use only in HP EliteBook 750/850 models)	744483-001
128-GB, locked (for use only in HP EliteBook 740/840 and ZBook 14 models)	766678-001
128-GB, locked, SanDisk	795941-001
120-GB, SSD	732681-001
120-GB, M.2 (for use only in HP EliteBook 750/850)	786035-001
32-GB, SSD	743008-001

Before removing the solid-state drive module, follow these steps:

1. Shut down the computer. If you are unsure whether the computer is off or in Hibernation, turn the computer on, and then shut it down through the operating system.
2. Disconnect all external devices connected to the computer.
3. Disconnect the power from the computer by first unplugging the power cord from the AC outlet and then unplugging the AC adapter from the computer.
4. Remove the service cover (see [Service cover on page 57](#)).
5. Disconnect the battery.

Remove the solid-state drive:

1. Remove the Phillips PM2.0×3.0 screw **(1)** that secures the drive to the computer.

2. Slide the drive away to remove it from the socket (2).

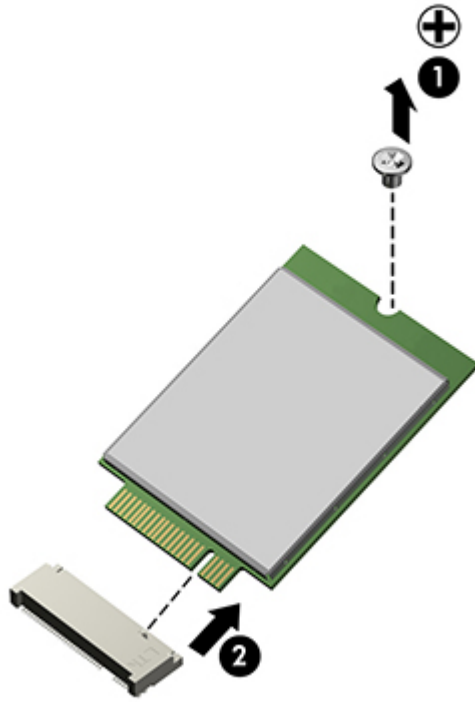

Reverse this procedure to install the solid-state drive.

RTC battery

Description	Spare part number
RTC battery (includes cable and double-sided tape)	665733-001

Before removing the RTC battery, follow these steps:

1. Turn off the computer. If you are unsure whether the computer is off or in Hibernation, turn the computer on, and then shut it down through the operating system.
2. Disconnect the power from the computer by unplugging the power cord from the computer.
3. Disconnect all external devices from the computer.
4. Remove the service cover (see [Service cover on page 57](#)).
5. Disconnect the battery.

Remove the RTC battery:

1. Disconnect the RTC battery cable **(1)** from the system board.
2. Pull the battery out from under the computer case **(2)**, and then remove the battery **(3)** from the base enclosure. (The RTC battery is attached to the base enclosure with double-sided tape.)

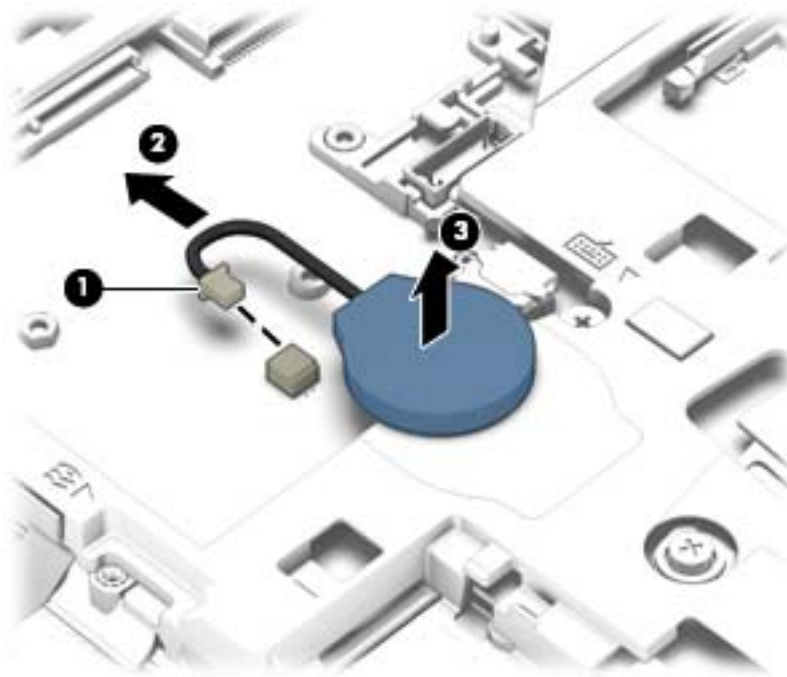

3. Remove the RTC battery.

Reverse this procedure to install the RTC battery.

Memory module

Description	Spare part number
8-GB memory module (PC3L, 12800, 1600-MHz)	693374-001
4-GB memory module (PC3L, 12800, 1600-MHz)	691740-001

Update BIOS before adding memory modules

Before adding new memory, make sure you update the computer to the latest BIOS.

 **CAUTION:** Failure to update the computer to the latest BIOS prior to installing new memory may result in various system problems.

To update BIOS:

1. Navigate to www.hp.com.
2. Click **Support & Drivers > click Drivers & Software**.
3. In the **Enter a product name/number box**, type the computer model information, and then click **Search**.
4. Click the link for the computer model.
5. Select the operating system, and then click **Next**.
6. Under **Step 2: Select a Download**, click the **BIOS** link.
7. Click the link for the most recent BIOS.
8. Click the **Download** button, and then follow the on-screen instructions.

Before removing a memory module, follow these steps:

1. Turn off the computer. If you are unsure whether the computer is off or in Hibernation, turn the computer on, and then shut it down through the operating system.
2. Disconnect the power from the computer by unplugging the power cord from the computer.
3. Disconnect all external devices from the computer.
4. Remove the service cover (see [Service cover on page 57](#)).
5. Disconnect the battery.

Remove the memory module:

1. Spread the retaining tabs **(1)** on each side of the memory module slot to release the memory module. (The edge of the module opposite the slot rises away from the computer.)

2. Remove the memory module **(2)** by pulling the module away from the slot at an angle.

 **NOTE:** Memory modules are designed with a notch to prevent incorrect insertion into the memory module slot.

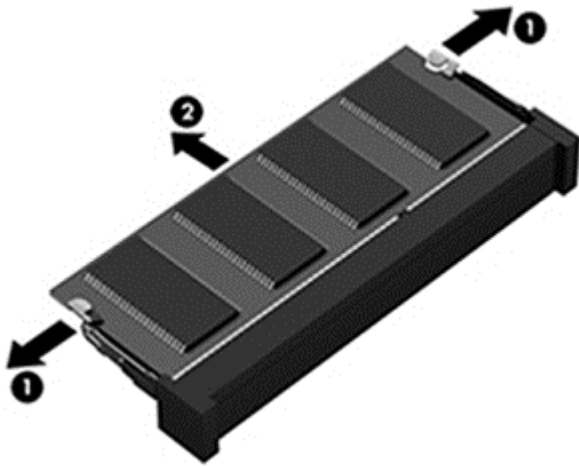

Reverse this procedure to install a memory module.

WWAN module



NOTE: The WWAN module and the WLAN module are not interchangeable.

Description	Spare part number
HP It4111 LTE/EV-DO/HSPA+ Mobile Broadband Module	704030-001
HP It4112 LTE/HSPA+ Gobi 4G Module	704031-001
HP hs3110 HSPA+ Mobile Broadband Module	723895-001

Before removing the WWAN module, follow these steps:

1. Turn off the computer. If you are unsure whether the computer is off or in Hibernation, turn the computer on, and then shut it down through the operating system.
2. Disconnect the power from the computer by unplugging the power cord from the computer.
3. Disconnect all external devices from the computer.
4. Remove the battery (see [Battery on page 59](#)).
5. Remove the service cover (see [Service cover on page 57](#)).

Remove the WWAN module:

1. Disconnect the WWAN antenna cables **(1)** from the terminals on the WWAN module.





NOTE: The red WWAN antenna cable is connected to the WWAN module “Main” terminal. The blue WWAN antenna cable is connected to the WWAN module “Aux” terminal.

2. Remove the Phillips PM2.0×3.0 screw **(2)** that secures the WWAN module to the base enclosure.

3. Remove the WWAN module (3) by pulling the module away from the slot.

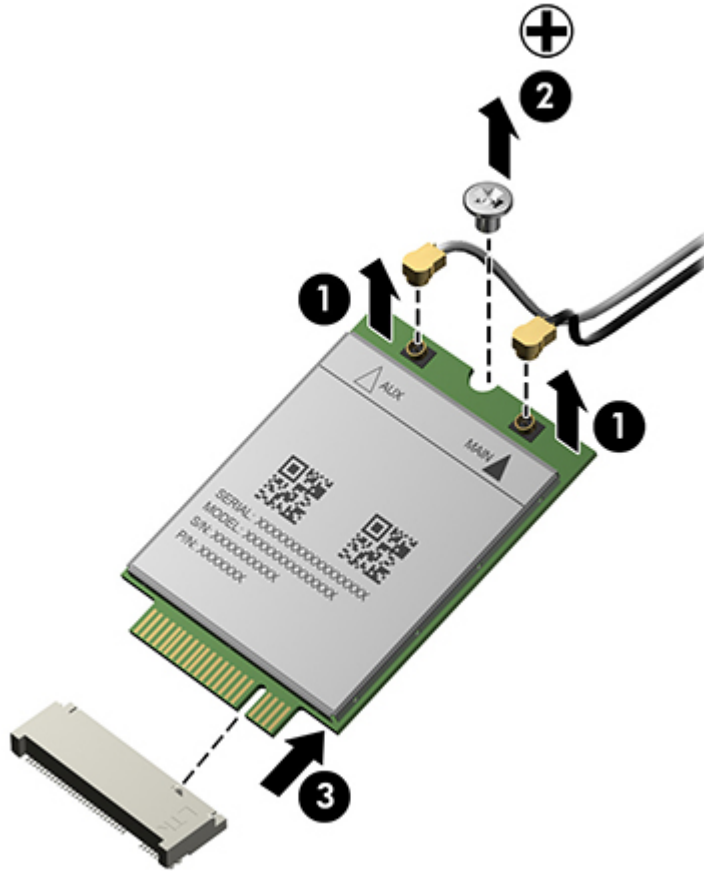
 **NOTE:** WWAN modules are designed with a notch to prevent incorrect insertion.



 **NOTE:** If the WWAN antennas are not connected to the terminals on the WWAN module, the protective sleeves must be installed on the antenna connectors, as shown in the following illustration.



Reverse this procedure to install the WWAN module.

WLAN module

Description	Spare part number
Intel Dual Band Wireless-AC 7260 802.11 ac 2x2 WiFi + BT 4.0	710661-001
Intel Dual Band Wireless-N 7260AN 802.11 a/b/g/n 2x2 WiFi + BT4.0	717381-001
Intel Dual Band Wireless-N 7260NB 802.11 a/b/g/n 2x2 WiFi + BT4.0	717382-001
Broadcom BCM943228HMB 802.11abgn 2x2 Wi-Fi + BT 4.0 Combo Adapter	697316-001
Intel Wireless-N 7260BN 802.11 b/g/n 2x2 WiFi + BT 4.0 combo adapter	717384-001
Intel Dual Band Wireless-N 7260AN 802.11 a/b/g/n 2x2 WiFi + BT4.0 (for use in Indonesia)	747832-001

 **CAUTION:** To prevent an unresponsive system, replace the wireless module only with a wireless module authorized for use in the computer by the governmental agency that regulates wireless devices in your country or region. If you replace the module and then receive a warning message, remove the module to restore device functionality, and then contact technical support.

Before removing the WLAN module, follow these steps:

1. Turn off the computer. If you are unsure whether the computer is off or in Hibernation, turn the computer on, and then shut it down through the operating system.
2. Disconnect the power from the computer by unplugging the power cord from the computer.
3. Disconnect all external devices from the computer.
4. Remove the service cover (see [Service cover on page 57](#)).
5. Disconnect the battery.

Remove the WLAN module:

1. Disconnect the WLAN antenna cables (**1**) from the terminals on the WLAN module.





NOTE: The WLAN antenna cable labeled “1” connects to the WLAN module “Main” terminal labeled “1”. The WLAN antenna cable labeled “2” connects to the WLAN module “Aux” terminal labeled “2”. If the computer is equipped with an 802.11a/b/g/n WLAN module, the yellow WLAN antenna cable connects to the middle terminal on the WLAN module.

2. Remove the two Phillips PM2.0×3.0 screws (**2**) that secure the WLAN module to the base enclosure. (The WLAN module tilts up.)

3. Remove the WLAN module (3) by pulling the module away from the slot at an angle.

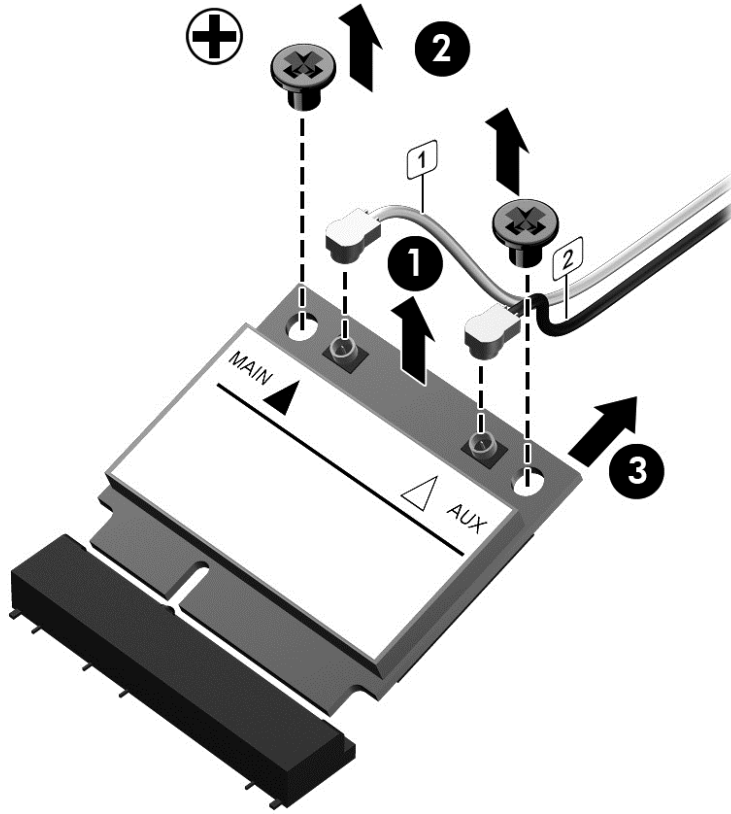
 **NOTE:** WLAN modules are designed with a notch to prevent incorrect insertion.



 **NOTE:** If the WLAN antennas are not connected to the terminals on the WLAN module, the protective sleeves must be installed on the antenna connectors, as shown in the following illustration.

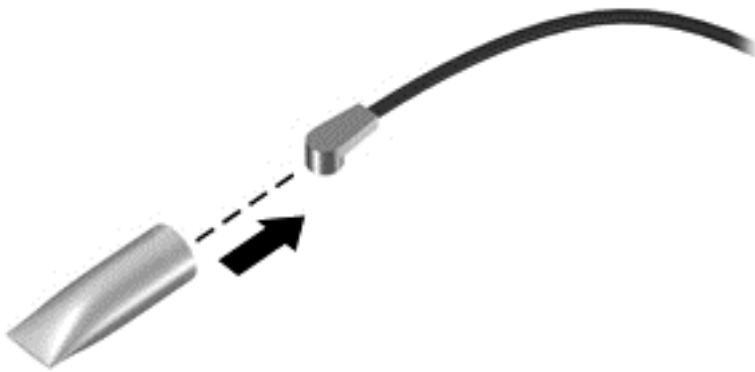

Reverse this procedure to install the WLAN module.

Keyboard



NOTE: For a detailed list of available keyboards, see [Sequential part number listing on page 38](#).

Description	Spare part number
Keyboard, backlit, with pointing stick	731179-xx1
Keyboard with pointing stick; no backlight	730794-xx1

Before removing the keyboard, follow these steps:

1. Turn off the computer. If you are unsure whether the computer is off or in Hibernation, turn the computer on, and then shut it down through the operating system.
2. Disconnect the power from the computer by unplugging the power cord from the computer.
3. Disconnect all external devices from the computer.
4. Remove the service cover (see [Hard drive on page 60](#)).
5. Remove the battery (see [Battery on page 59](#)).

Remove the keyboard:

1. Loosen the two Phillips captive screws that secure the keyboard to the computer.

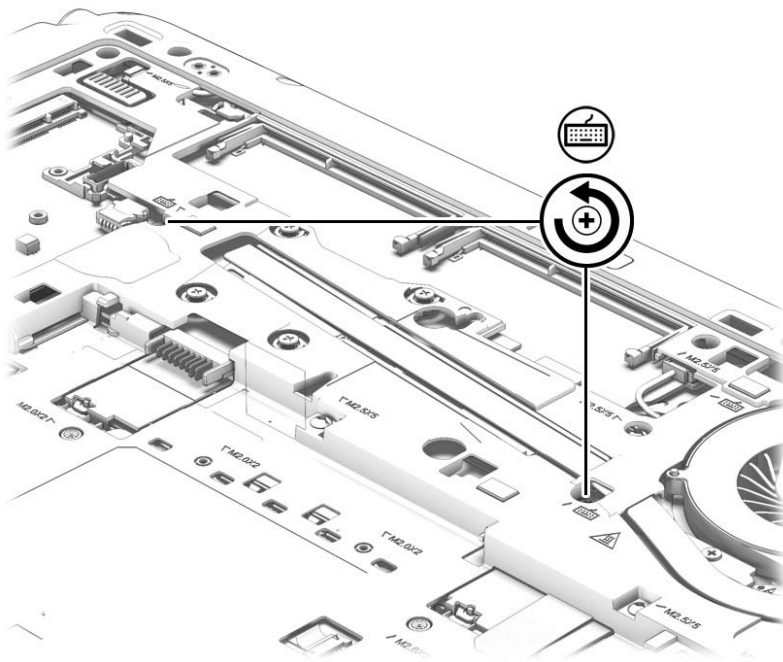

2. Rest and secure the partially open computer on its side.

3. Insert a screw driver or similar thin tool into the keyboard release hole, and then press on the back of the keyboard until the keyboard disengages from the computer.

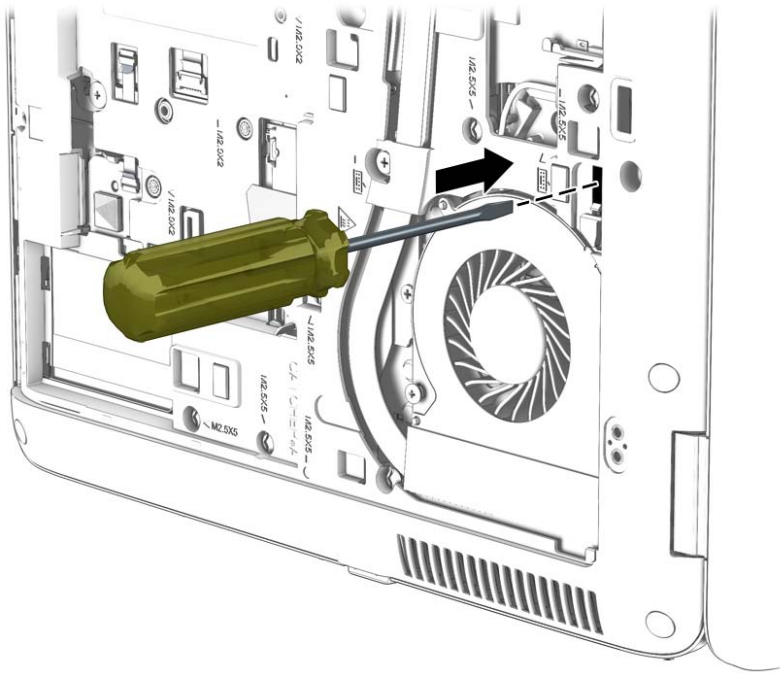

4. Position the computer right-side up with the front toward you.
5. Lift the rear edge of the keyboard upward.



 **NOTE:** The backlight cable is present only on HP EliteBook 850 models.

6. To remove the keyboard from HP EliteBook 840/HP ZBook14 models:
 - a. Swing the keyboard up and forward **(1)** until it rests upside down on the palm rest.
 - b. Disconnect the main keyboard cable from the zero insertion force (ZIF) connector **(2)** on the system board.

- c. Disconnect the pointing stick cable from the zero insertion force (ZIF) connector **(3)** on the system board.
- d. Remove the keyboard **(4)**.

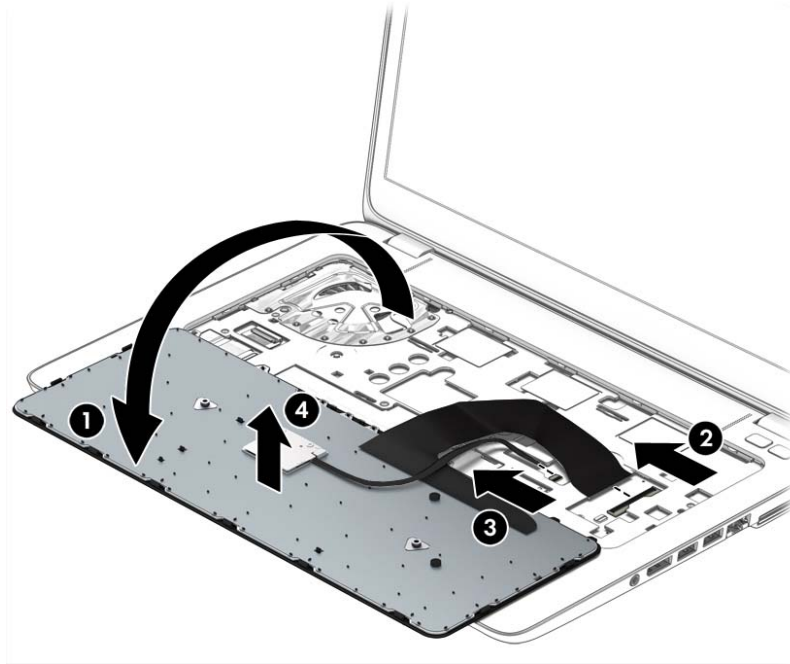

- 7. To remove the keyboard from HP EliteBook 850 models:
 - a. Swing the keyboard up and forward **(1)** until it rests upside down on the palm rest.
 - b. Disconnect the main keyboard cable from the zero insertion force (ZIF) connector **(2)** on the system board.
 - c. Disconnect the pointing stick cable from the zero insertion force (ZIF) connector **(3)** on the system board.
 - d. Disconnect the backlight cable from the zero insertion force (ZIF) connector **(4)** on the system board.

- e. Remove the keyboard (5).



Reverse this procedure to install the keyboard.

6 Removal and replacement procedures for Authorized Service Provider parts

 **CAUTION:** Components described in this chapter should only be accessed by an authorized service provider. Accessing these parts can damage the computer or void the warranty.

Component replacement procedures

 **NOTE:** Details about your computer, including model, serial number, product key, and length of warranty, are on the service tag at the bottom of your computer. See [Service tag and PCID label on page 21](#) for details.

This chapter provides removal and replacement procedures for Authorized Service Provider only parts.

There are as many as 61 screws that must be removed, replaced, and/or loosened when servicing the Authorized Service Provider parts. Make special note of each screw size and location during removal and replacement.

Display panel (non-touch)

 **NOTE:** HP EliteBook 840 models offer both touch and non-touch displays. Non-touch displays are spared at the subcomponent level only. Touch displays are only spared as a whole (touch display components are not spared).

In non-touch models, you can remove the raw display panel with the display assembly still connected to the computer. The following section shows how to remove the raw display panel without removing the display assembly from the computer.

See [Display assembly on page 108](#) later in this chapter to remove internal components that require that you remove the display assembly.

Description	Spare part number
Display bezel	
Display bezel for use in HP EliteBook 840 models	730952-001
Display bezel for use in HP EliteBook 740 models	784451-001
Display bezel for use in HP ZBook 14 models	730953-001
Display bezel for use in HP EliteBook 850 models	730814-001
Display bezel for use in HP EliteBook 750 models	784478-001
Display panel	
(35.6-cm) 14.0-in LED, HD, AntiGlare (AG), SVA (1366×768), 200 nits	737657-001
(35.6-cm) 14.0-in LED, HD+, AG, SVA (1920×1080), 250 nits	737658-001
(35.6-cm) 14.0-in LED, FHD, AG, SVA (1920×1080), 300 nits	737659-001
(39.6-cm) 15.6-in LED, HD, AG, SVA (1368×768), 300 nits	733684-001

Description	Spare part number
(39.6-cm) 15.6-in LED, FHD, AG, SVA (1920×1080), 200 nits	733685-001
Webcam module	730542-001
Microphone module	730795-001

Before removing the display assembly, follow these steps:

1. Turn off the computer. If you are unsure whether the computer is off or in Hibernation, turn the computer on, and then shut it down through the operating system.
2. Disconnect the power from the computer by unplugging the power cord from the computer.
3. Disconnect all external devices from the computer.
4. Remove the service cover (see [Service cover on page 57](#)).
5. Disconnect the battery.

Remove the display panel:

1. Lift to disengage the bezel on the bottom **(1)**, left and right sides **(2)**, and top **(3)**.
2. Remove the bezel from the display assembly **(4)**.

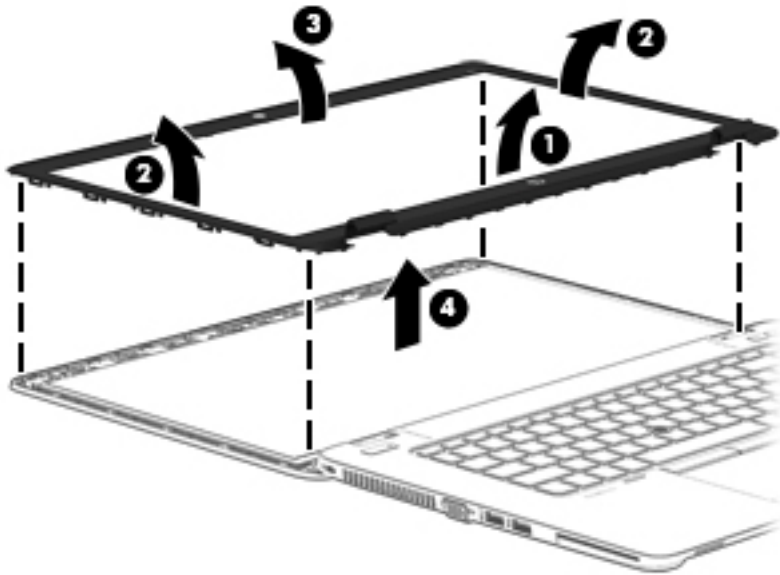

3. Remove the four Phillips PM2.0×3.0 screws **(1)** that secure the display panel to the display enclosure.

4. Lift and rotate the panel onto the computer (2).

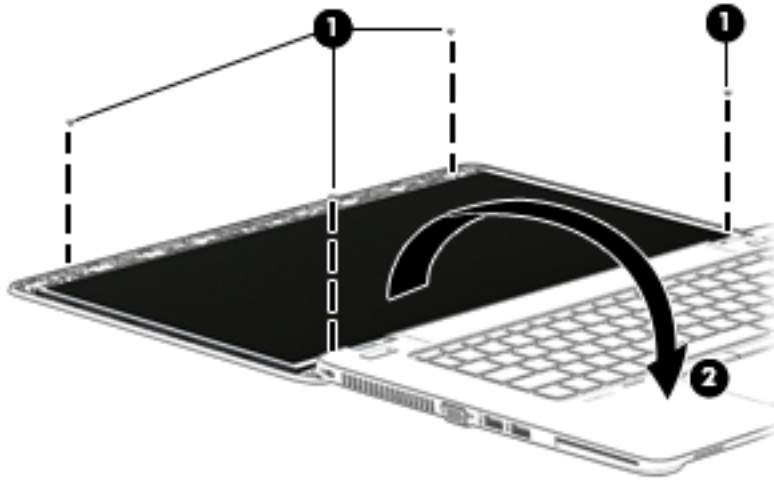

5. On the back of the display panel, lift the tape that secures the display cable to the display panel (1), and the disconnect the display cable from the panel (2).

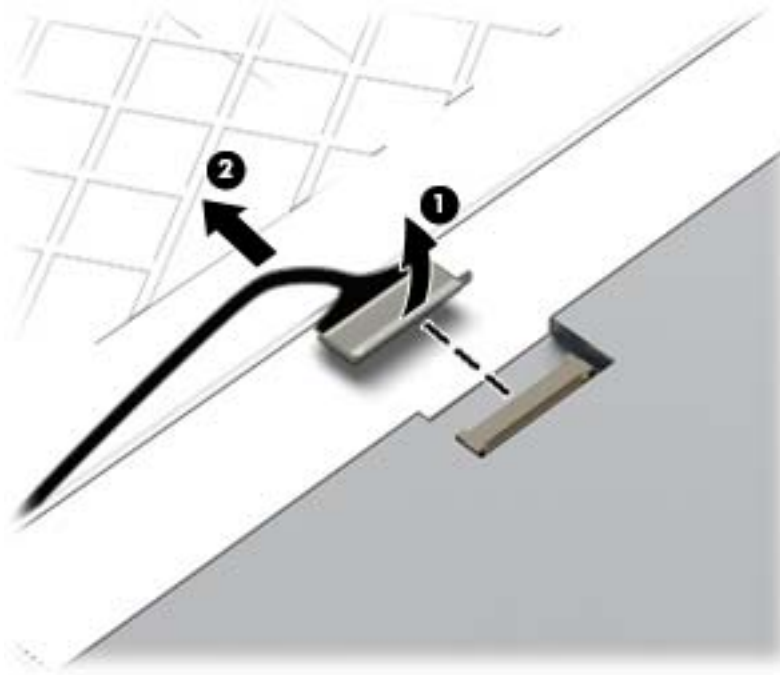

6. Lift the display panel from the display enclosure.

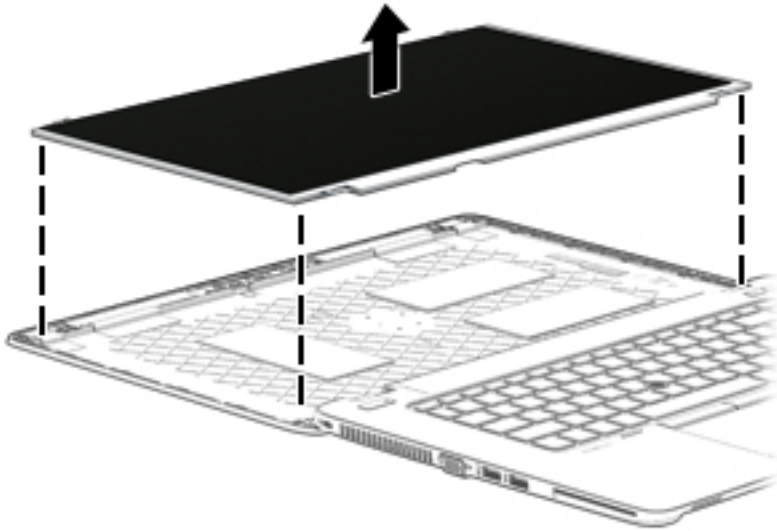

7. If it is necessary to replace the webcam/microphone module:

- a. Release the tape that secures the webcam cable to the module **(1)**.
- b. Disconnect the cable **(2)** from the module.

⚠ CAUTION: Handle the module with caution. The module has a thin profile and is susceptible to damage when not handled carefully.

- c. Remove the module **(3)** from the display enclosure. (The module is attached to the display enclosure with double-sided tape.)

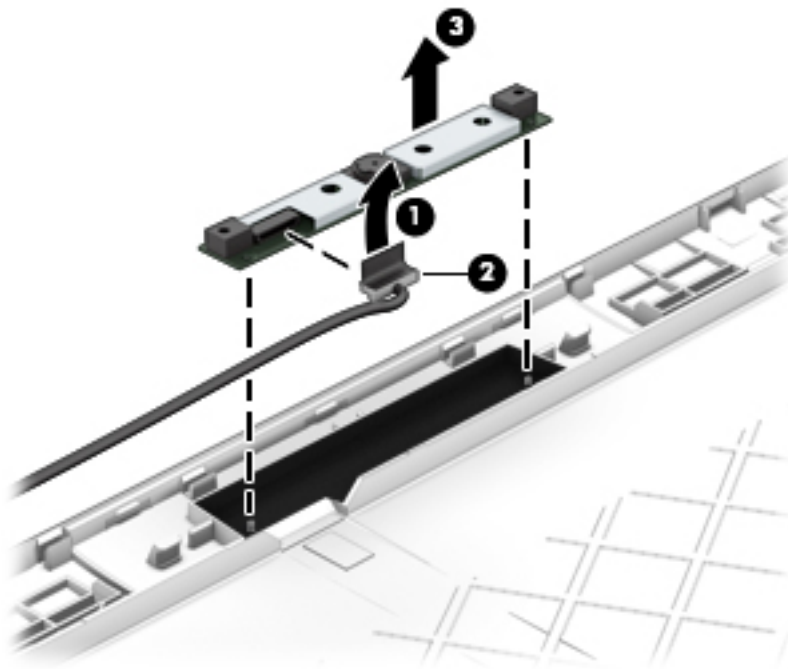

Reverse this procedure to reassemble and install the display panel components.

Base enclosure

Base enclosure removal procedures for HP EliteBook 840/HP ZBook 14 models and HP EliteBook 15 models are in separated in the following sections.

Base enclosure (HP EliteBook 840/HP ZBook14 models)

Description	Spare part number
Base enclosure for use only on HP EliteBook 740/840 models	765809-001
Base enclosure for use only on HP ZBook 14 models	765810-001

Before removing the base enclosure, follow these steps:

1. Turn off the computer. If you are unsure whether the computer is off or in Hibernation, turn the computer on, and then shut it down through the operating system.
2. Disconnect the power from the computer by unplugging the power cord from the computer.
3. Disconnect all external devices from the computer.
4. Remove the following components:
 - a. Service cover (see [Service cover on page 57](#))
 - b. Battery (see [Battery on page 59](#))
 - c. Keyboard (see [Keyboard on page 71](#))

Use the following image as an overview of all base enclosure screw locations.

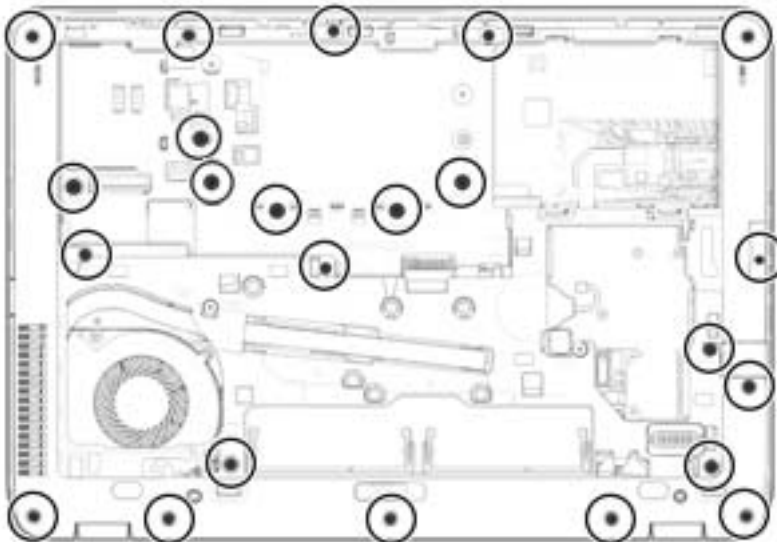

Remove the base enclosure:

1. Position the computer upside down.

2. Remove the seven rubber screw covers from the screws outside of the service cover.

 **NOTE:** The eight screws outside of the service cover also have rubber covers.

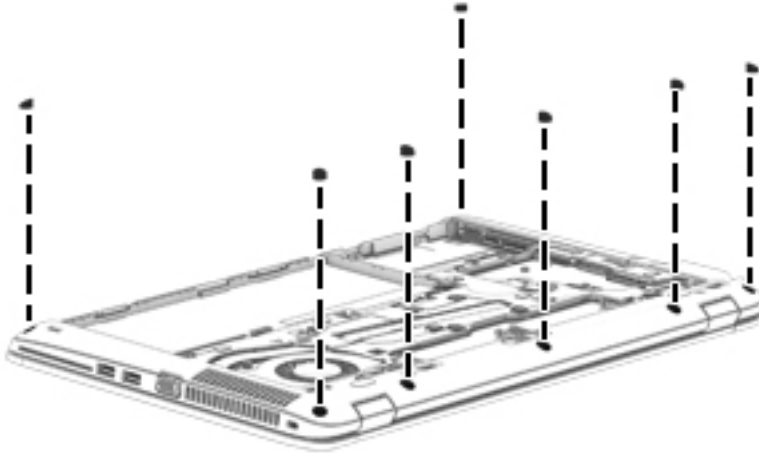

3. Remove the 16 Torx T8M2.5×5.0 screws that secure the base enclosure to the computer.

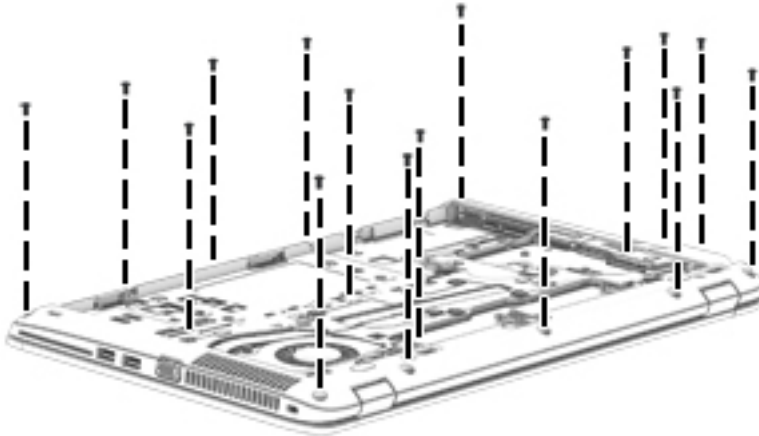

4. Remove the Phillips PM2.0×8.0 screw **(1)** near the media card reader and the six Phillips PM2.0×5.0 broadhead screws **(2)** inside the battery bay that secure the base enclosure to the computer.

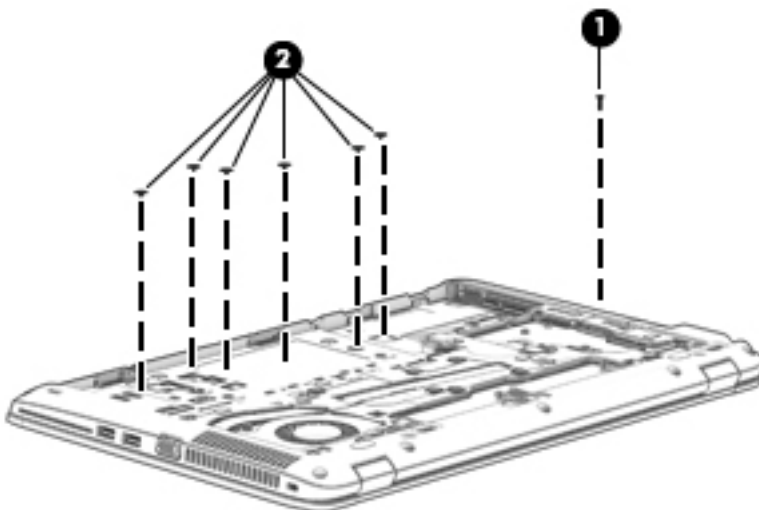

5. Lift the base enclosure off the computer.

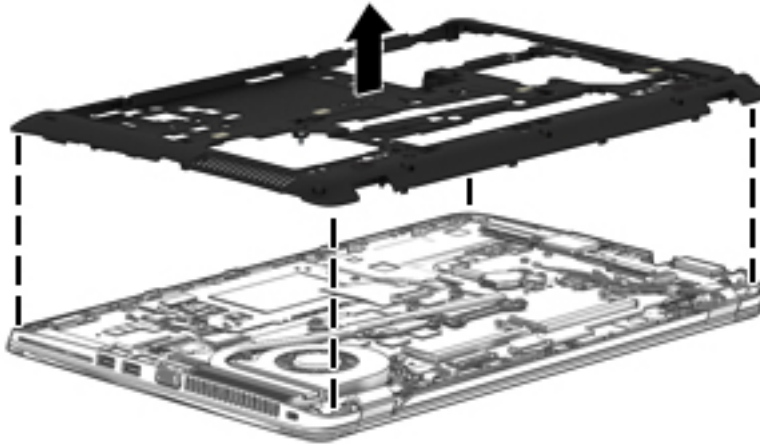

Reverse this procedure to install the base enclosure.

Base enclosure (HP EliteBook 850 models)

Description	Spare part number
Base enclosure for use only on HP EliteBook 750/850 models (includes RJ-45 door with spring)	730813-001
Base enclosure for use only on HP EliteBook 750/850 models, ESD (includes RJ-45 door with spring)	765811-001

Before removing the base enclosure, follow these steps:

1. Turn off the computer. If you are unsure whether the computer is off or in Hibernation, turn the computer on, and then shut it down through the operating system.
2. Disconnect the power from the computer by unplugging the power cord from the computer.
3. Disconnect all external devices from the computer.
4. Remove the following components:
 - a. Service cover (see [Service cover on page 57](#))
 - b. Battery (see [Battery on page 59](#))
 - c. Keyboard (see [Keyboard on page 71](#))

Use the following image as an overview of all base enclosure screw locations.

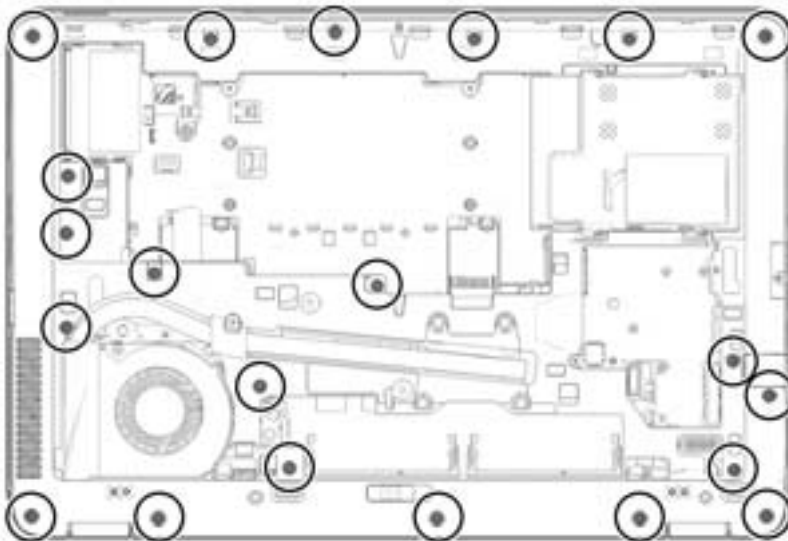

Remove the base enclosure:

1. Position the computer upside down.

2. Remove the seven rubber screw covers from the screws outside of the service cover.

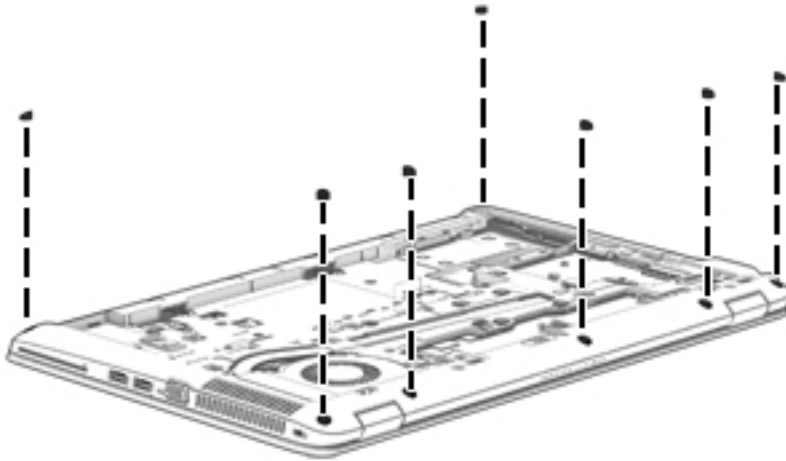

3. Remove the 21 Torx T8M2.5×5.0 screws that secure the base enclosure to the computer.

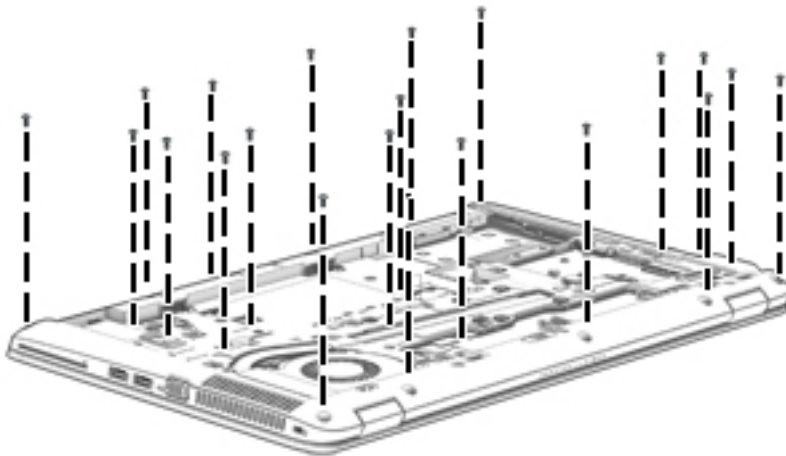

4. Remove the Phillips PM2.0×8.0 screw (1) near the media card reader and the five Phillips PM2.0×5.0 broadhead screws (2) inside the battery bay that secure the base enclosure to the computer.

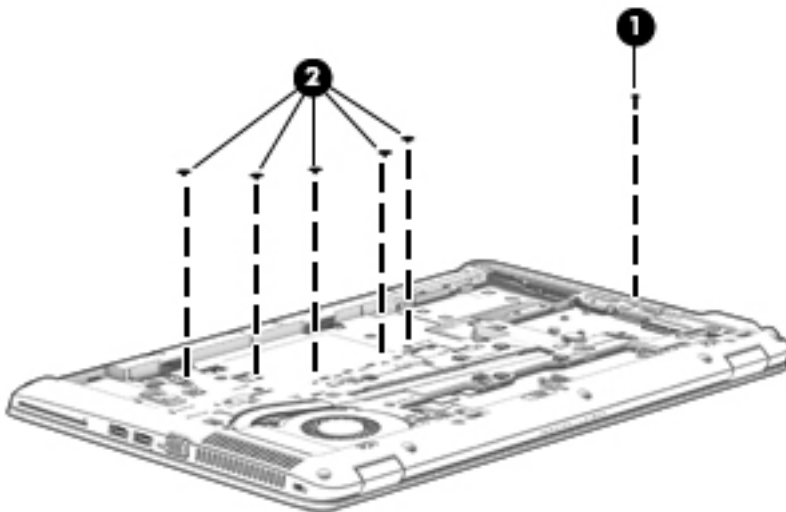

5. Lift the base enclosure off the computer.

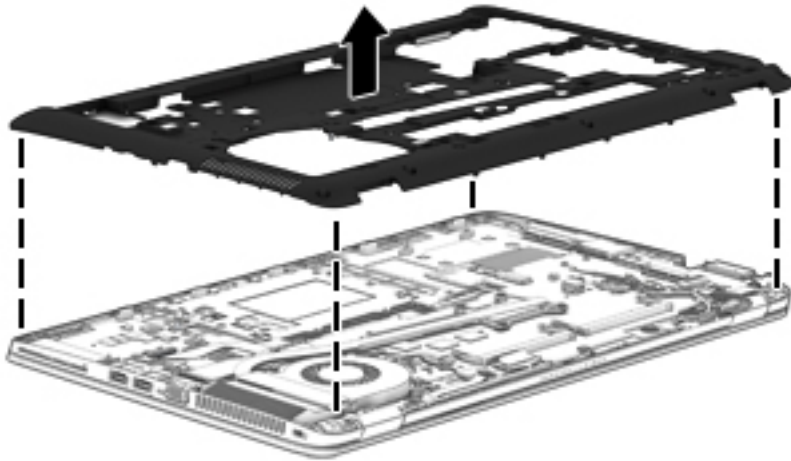

Reverse this procedure to install the base enclosure.

Fan

Description	Spare part number
Fan (includes cable)	730792-001

Before removing the fan, follow these steps:

1. Turn off the computer. If you are unsure whether the computer is off or in Hibernation, turn the computer on, and then shut it down through the operating system.
2. Disconnect the power from the computer by unplugging the power cord from the computer.
3. Disconnect all external devices from the computer.
4. Remove the service cover (see [Service cover on page 57](#)).
5. Remove the battery (see [Battery on page 59](#)).
6. Remove the keyboard (see [Keyboard on page 71](#)).
7. Remove the base enclosure (see [Base enclosure on page 79](#)).

Remove the fan:

1. Loosen the two captive Phillips screws **(1)** that secure the fan to the base enclosure.
2. Disconnect the fan cable **(2)** from the system board.
3. Remove the fan **(3)**.

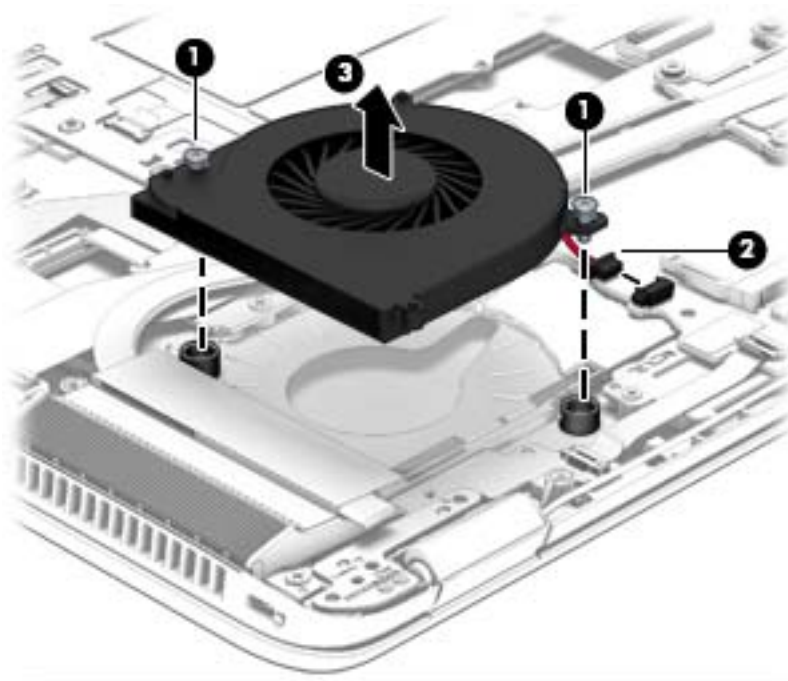

Reverse this procedure to install the fan.

Card reader board

Description	Spare part number
Card reader board for use in HP EliteBook 740/840/HP ZBook 14 models	730955-001
Card reader board for use in HP EliteBook 750/850 models	730821-001

Before removing the card reader board, follow these steps:

1. Turn off the computer. If you are unsure whether the computer is off or in Hibernation, turn the computer on, and then shut it down through the operating system.
2. Disconnect the power from the computer by unplugging the power cord from the computer.
3. Disconnect all external devices from the computer.
4. Remove the following components:
 - a. Service cover (see [Service cover on page 57](#))
 - b. Battery (see [Battery on page 59](#))
 - c. Fan (see [Fan on page 85](#))
 - d. Keyboard (see [Keyboard on page 71](#))
 - e. Base enclosure (see [Base enclosure on page 79](#))

Remove the card reader board:

1. Disconnect the larger card reader cable **(1)** and the smaller touchpad cable **(2)** from the the card reader board.
2. Using a thin tool, pry up the left side of the board to disengage it from the top cover **(3)**.
3. Remove the card reader board **(4)**.

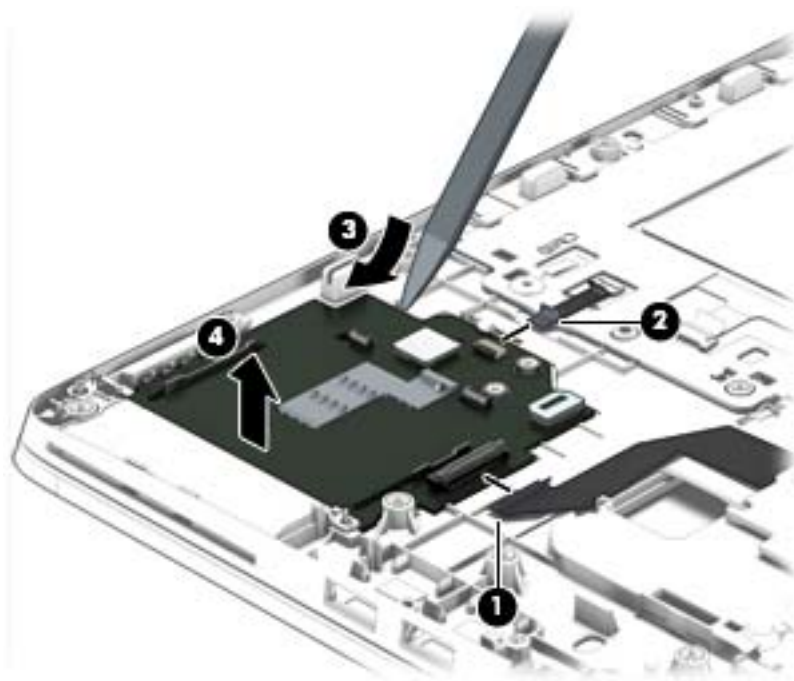

Reverse this procedure to install the card reader board.

VGA/USB board

Description	Spare part number
VGA/USB board for use in HP EliteBook 740/840/HP ZBook 14 models	730966-001
VGA/USB board for use in HP EliteBook 750/850 models	730820-001

Before removing the VGA/USB board, follow these steps:

1. Turn off the computer. If you are unsure whether the computer is off or in Hibernation, turn the computer on, and then shut it down through the operating system.
2. Disconnect the power from the computer by unplugging the power cord from the computer.
3. Disconnect all external devices from the computer.
4. Remove the following components:
 - a. Service cover (see [Service cover on page 57](#))
 - b. Battery (see [Battery on page 59](#))
 - c. Fan (see [Fan on page 85](#))
 - d. Keyboard (see [Keyboard on page 71](#))
 - e. Base enclosure (see [Base enclosure on page 79](#))

Remove the VGA/USB board:

1. Disconnect the cable from the VGA/USB board **(1)**.
2. Remove the two Phillips PM2.0×5.0 screws **(2)** that secure the VGA/USB board to the top cover.

3. Remove the VGA/USB board from the top cover (3).

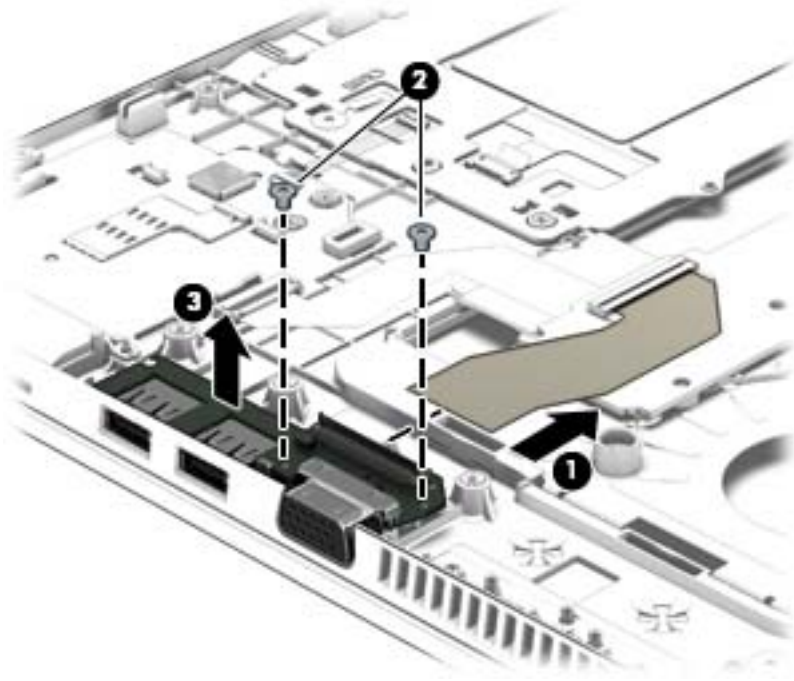

Reverse this procedure to install the VGA/USB board.

Heat sink

 **NOTE:** The heat sink spare part kit includes replacement thermal material.

Description	Spare part number
For use only on HP EliteBook 740/840/HP ZBook 14 models with discrete graphics	730962-001
For use only on HP EliteBook 740/840/HP ZBook 14 models with UMA graphics	730963-001
For use only on HP EliteBook 750/850 models with discrete graphics	732626-001
For use only on HP EliteBook 750/850 models with UMA graphics	730815-001

Before removing the heat sink, follow these steps:

1. Turn off the computer. If you are unsure whether the computer is off or in Hibernation, turn the computer on, and then shut it down through the operating system.
2. Disconnect the power from the computer by unplugging the power cord from the computer.
3. Disconnect all external devices from the computer.
4. Remove the following components:
 - a. Service cover (see [Service cover on page 57](#))
 - b. Battery (see [Battery on page 59](#))
 - c. Fan (see [Fan on page 85](#))

- d. Keyboard (see [Keyboard on page 71](#))
- e. Base enclosure (see [Base enclosure on page 79](#))

Remove the heat sink:

 **NOTE:** Step 2 applies to computer models equipped with a graphics subsystem with discrete memory. See step 3 for heat sink removal information for computer models equipped with a graphics subsystem with UMA memory.

1. Following the 1, 2, 3, 4, 5, 6 sequence stamped into the heat sink, loosen the six captive Phillips screws **(1) – (6)** that secure the heat sink to the system board, and then remove the heat sink **(7)**.

 **NOTE:** Due to the adhesive quality of the thermal material located between the heat sink and the system board components, it may be necessary to move the heat sink from side to side to detach it.

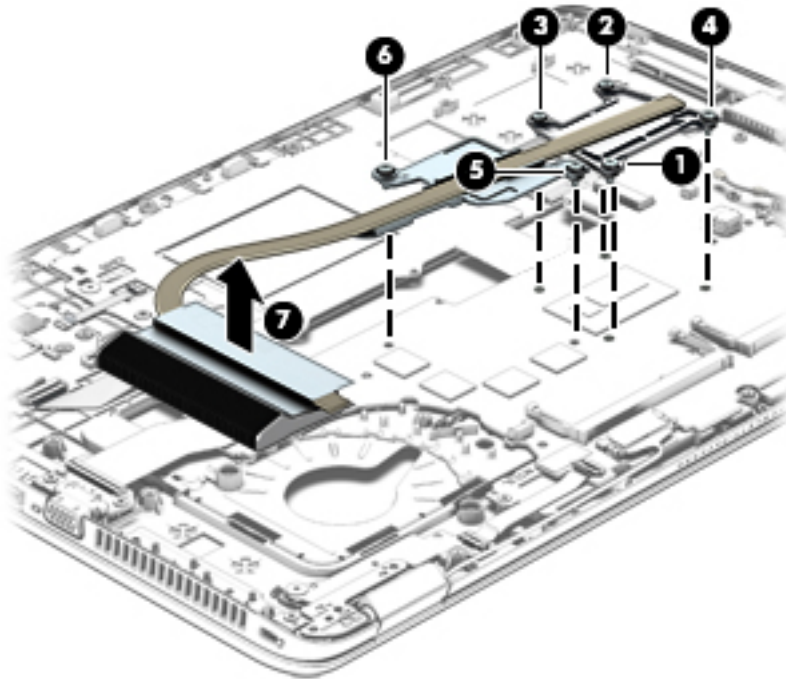

- Following the 1, 2, 3, 4 sequence stamped into the heat sink, loosen the four captive Phillips screws **(1)** – **(4)** that secure the heat sink to the system board, and then remove the heat sink **(5)**.

 **NOTE:** Due to the adhesive quality of the thermal material located between the heat sink and the system board components, it may be necessary to move the heat sink from side to side to detach it.

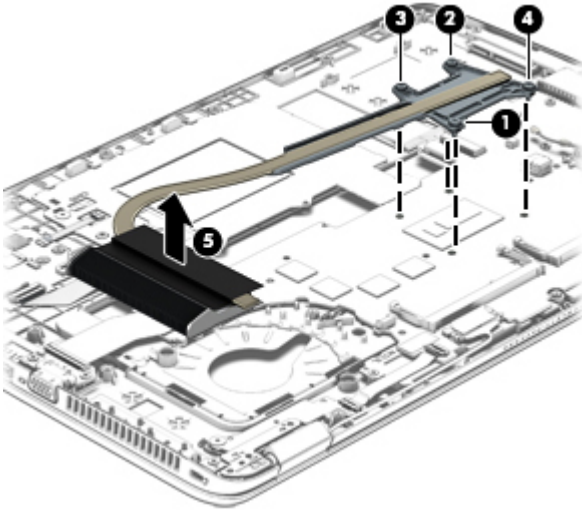

- The following illustrations show the replacement thermal material locations. The thermal material must be thoroughly cleaned from the surfaces of the heat sink and the system board components each time the heat sink is removed. Replacement thermal material is included with the heat sink, processor, and system board spare part kits.

a. Discrete models:

Thermal paste is used on the system board components **(1)** and **(3)** and on the heat sink areas **(2)** and **(4)** that services them.

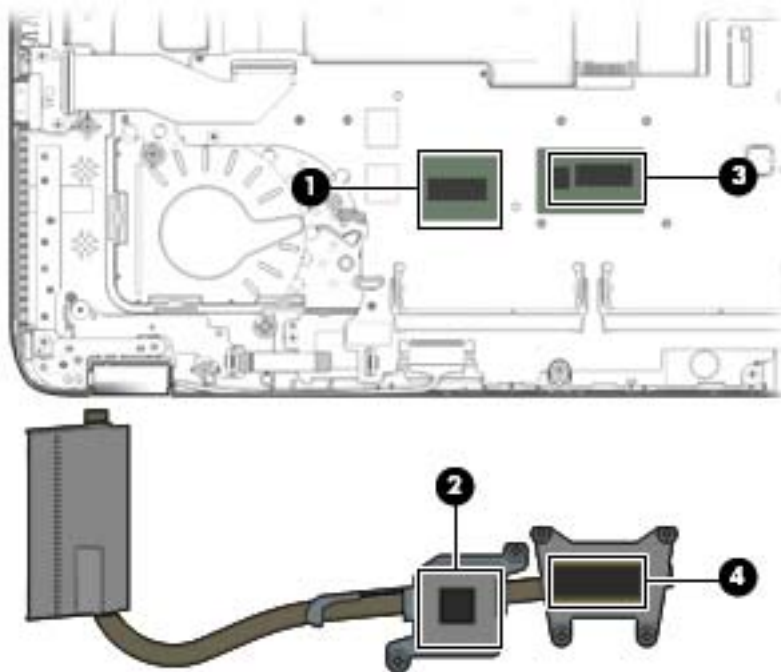

b. UMA models:

Thermal paste is used on the system board component **(1)** and on the heat sink area **(2)** that services it.

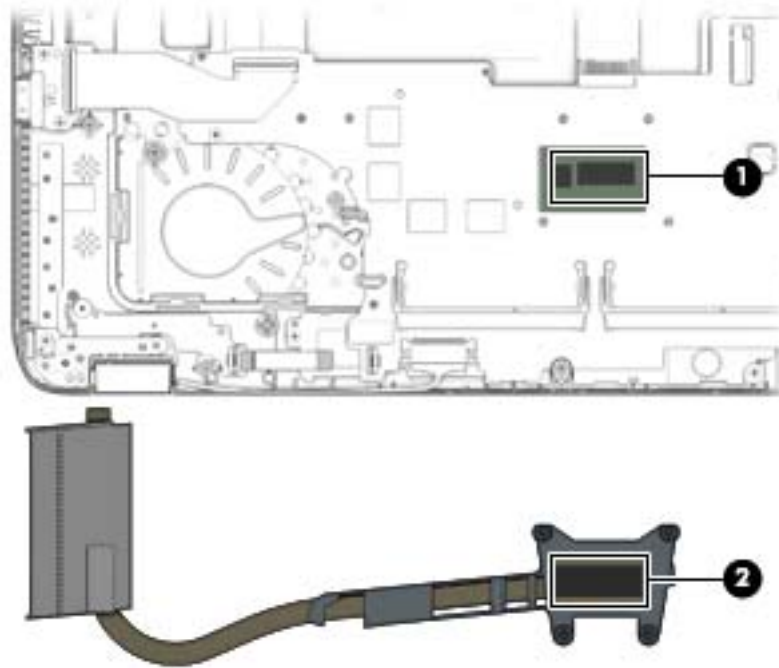

Reverse this procedure to install the heat sink.

Power button board

Description	Spare part number
Power button board for use in HP EliteBook 740/840/HP ZBook 14 models	730959-001
Power button board for use in HP EliteBook 750/850 models	730822-001

Before removing the power button board, follow these steps:

1. Turn off the computer. If you are unsure whether the computer is off or in Hibernation, turn the computer on, and then shut it down through the operating system.
2. Disconnect the power from the computer by unplugging the power cord from the computer.
3. Disconnect all external devices from the computer.
4. Remove the following components:
 - a. Service cover (see [Service cover on page 57](#))
 - b. Battery (see [Battery on page 59](#))
 - c. Fan (see [Fan on page 85](#))
 - d. Keyboard (see [Keyboard on page 71](#))
 - e. Base enclosure (see [Base enclosure on page 79](#))
 - f. Heat sink (see [Heat sink on page 88](#))

Remove the power button board:

1. Disconnect the power button board cable from the power button board **(1)**.
2. Remove the broadhead Phillips PM2.0×3.0 screw that secures the board **(2)** to the top cover.

3. Slide the power toward the inside of the top cover, and then lift it off the top cover **(3)**.

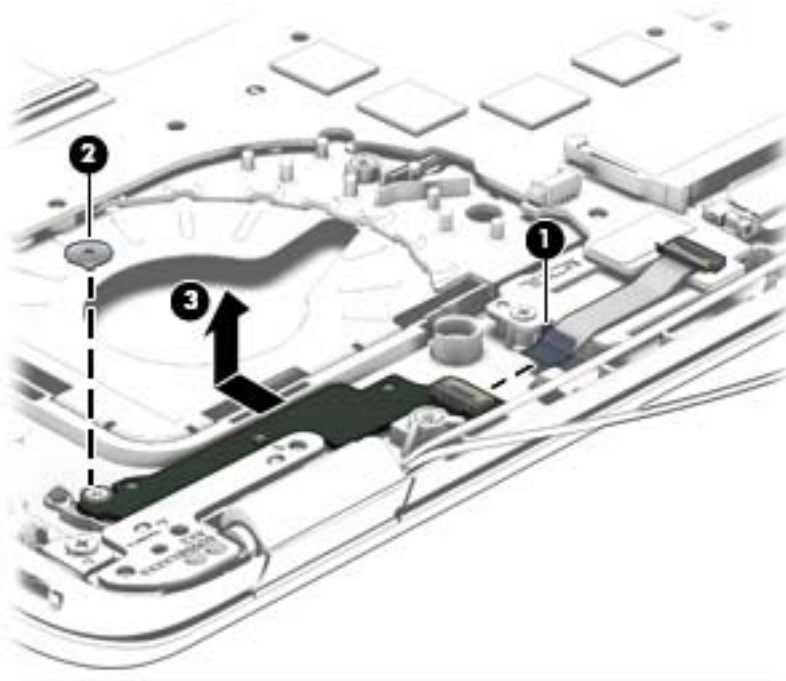

Reverse this procedure to install the power button board.

Fingerprint reader assembly

Description	Spare part number
Fingerprint reader assembly for use in HP EliteBook 740/840/HP ZBook 14 models (includes cable, bracket, and insulator)	730956-001
Fingerprint reader assembly for use in HP EliteBook 750/850 models (includes cable, bracket, and insulator)	730817-001

Before removing the fingerprint reader assembly, follow these steps:

1. Turn off the computer. If you are unsure whether the computer is off or in Hibernation, turn the computer on, and then shut it down through the operating system.
2. Disconnect the power from the computer by unplugging the power cord from the computer.
3. Disconnect all external devices from the computer.
4. Remove the following components:
 - a. Service cover (see [Service cover on page 57](#))
 - b. Battery (see [Battery on page 59](#))
 - c. Fan (see [Fan on page 85](#))
 - d. Keyboard (see [Keyboard on page 71](#))
 - e. Base enclosure (see [Base enclosure on page 79](#))

Remove the fingerprint reader assembly:

1. Turn the computer upside down.
2. Remove Mylar cover from atop the that secure the fingerprint reader assembly **(1)**.

3. Slide the bracket from atop the fingerprint reader board (2), and then remove the fingerprint reader board (3) from the computer.

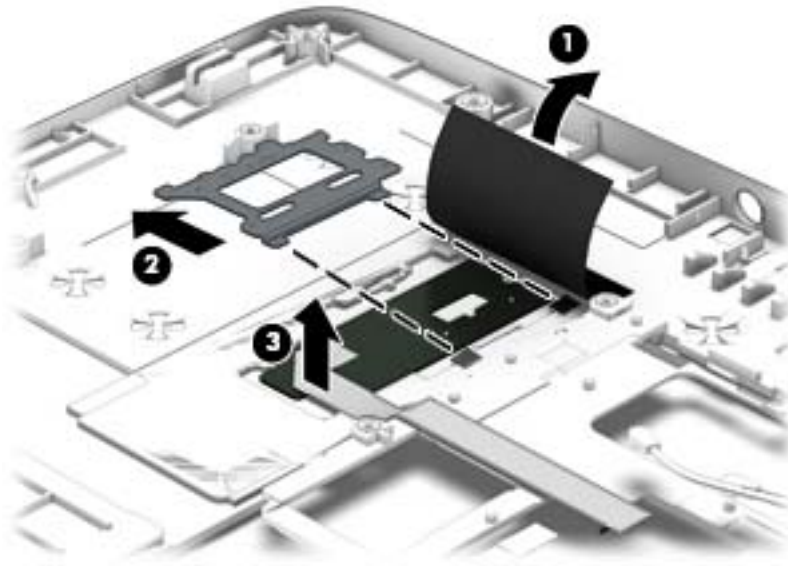

Reverse this procedure to install the fingerprint reader assembly.

System board

 **NOTE:** The system board spare part kit includes replacement thermal material.

 **IMPORTANT:** For system board replacement on serial numbers xxx501xxxx and below, you must use a conversion kit (see product description for “(Gold Conversion Kit)”). For serial numbers xxx502xxxx and above, use the standard spare kit (see product description for “(Gold)”).

Description	Spare part number
System board for use in models with discrete graphics:	
Intel Core i7-4600U processor for use with the Windows 8 Professional operating system for use in EliteBook 750/850 models (Gold)	802519-601
Intel Core i7-4600U processor for use with the Windows 8 Standard operating system for use in EliteBook 750/850 models (Gold)	802519-501
Intel Core i7-4600U processor for use with models without the Windows 8 operating system for use in EliteBook 750/850 models (Gold)	802519-001
Intel Core i7-4600U processor for use with the Windows 8 Professional operating system (Gold)	802518-601
Intel Core i7-4600U processor for use with the Windows 8 Standard operating system (Gold)	802518-501
Intel Core i7-4600U processor for use with models without the Windows 8 operating system (Gold)	802518-001
Intel Core i7-4600U processor for use with the Windows 8 Professional operating system for use in ZBook 14 models (Gold)	802522-601
Intel Core i7-4600U processor for use with the Windows 8 Standard operating system for use in ZBook 14 models (Gold)	802522-501
Intel Core i7-4600U processor for use with models without the Windows 8 operating system for use in ZBook 14 models (Gold)	802522-001
Intel Core i7-4510U processor for use with the Windows 8 Professional operating system for use in EliteBook 740/840 and 750/850 models (Gold)	802536-601
Intel Core i7-4510U processor for use with the Windows 8 Standard operating system for use in EliteBook 740/840 and 750/850 models (Gold)	802536-501
Intel Core i7-4510U processor for use with models without the Windows 8 operating system for use in EliteBook 740/840 and 750/850 models (Gold)	802536-001
Intel Core i7-4510U processor for use with the Windows 8 Professional operating system for use in ZBook 14 models (Gold)	802528-601
Intel Core i7-4510U processor for use with the Windows 8 Standard operating system for use in ZBook 14 models (Gold)	802528-501
Intel Core i7-4510U processor for use with models without the Windows 8 operating system for use in ZBook 14 models (Gold)	802528-001
Intel Core i7-4500U processor for use with the Windows 8 Professional operating system for use in EliteBook 740/840 and 750/850 models (Gold)	802524-601
Intel Core i7-4500U processor for use with the Windows 8 Standard operating system for use in EliteBook 740/840 and 750/850 models (Gold)	802524-501
Intel Core i7-4500U processor for use with models without the Windows 8 operating system for use in EliteBook 740/840 and 750/850 models (Gold)	802524-001
Intel Core i7-4500U processor for use with the Windows 8 Professional operating system for use in ZBook 14 models (Gold)	802525-601

Description	Spare part number
Intel Core i7-4500U processor for use with the Windows 8 Standard operating system for use in ZBook 14 models (Gold)	802525-501
Intel Core i7-4500U processor for use with models without the Windows 8 operating system for use in ZBook 14 models (Gold)	802525-001
Intel Core i5-4310U processor for use with the Windows 8 Professional operating system for use in EliteBook 740/840 and 750/850 models (Gold)	802534-601
Intel Core i5-4310U processor for use with the Windows 8 Standard operating system for use in EliteBook 740/840 and 750/850 models (Gold)	802534-501
Intel Core i5-4310U processor for use with models without the Windows 8 operating system for use in EliteBook 740/840 and 750/850 models (Gold)	802534-001
Intel Core i5-4310U processor for use with the Windows 8 Professional operating system for use in ZBook 14 models (Gold)	802527-601
Intel Core i5-4310U processor for use with the Windows 8 Standard operating system for use in ZBook 14 models (Gold)	802527-501
Intel Core i5-4310U processor for use with models without the Windows 8 operating system for use in ZBook 14 models (Gold)	802527-001
Intel Core i5-4300U processor for use with the Windows 8 Professional operating system for use in EliteBook 740/840 and 750/850 models (Gold)	802512-601
Intel Core i5-4300U processor for use with the Windows 8 Standard operating system for use in EliteBook 740/840 and 750/850 models (Gold)	802512-501
Intel Core i5-4300U processor for use with models without the Windows 8 operating system for use in EliteBook 740/840 and 750/850 models (Gold)	802512-001
Intel Core i5-4300U processor for use with the Windows 8 Professional operating system for use in ZBook 14 models (Gold)	802521-601
Intel Core i5-4300U processor for use with the Windows 8 Standard operating system for use in ZBook 14 models (Gold)	802521-501
Intel Core i5-4300U processor for use with models without the Windows 8 operating system for use in ZBook 14 models (Gold)	802521-001
Intel Core i5-4210U processor for use with the Windows 8 Professional operating system for use in EliteBook 740/840 and 750/850 models (Gold)	802532-601
Intel Core i5-4210U processor for use with the Windows 8 Standard operating system for use in EliteBook 740/840 and 750/850 models (Gold)	802532-501
Intel Core i5-4210U processor for use with models without the Windows 8 operating system for use in EliteBook 740/840 and 750/850 models (Gold)	802532-001
Intel Core i5-4210U processor for use with the Windows 8 Professional operating system for use in ZBook 14 models (Gold)	802526-601
Intel Core i5-4210U processor for use with the Windows 8 Standard operating system for use in ZBook 14 models (Gold)	802526-501
Intel Core i5-4210U processor for use with models without the Windows 8 operating system for use in ZBook 14 models (Gold)	802526-001
Intel Core i5-4200U processor for use with the Windows 8 Professional operating system for use in EliteBook 740/840 and 750/850 models (Gold)	802517-601
Intel Core i5-4200U processor for use with the Windows 8 Standard operating system for use in EliteBook 740/840 and 750/850 models (Gold)	802517-501

Description	Spare part number
Intel Core i5-4200U processor for use with models without the Windows 8 operating system for use in EliteBook 740/840 and 750/850 models (Gold)	802517-001
Intel Core i5-4200U processor for use with the Windows 8 Professional operating system for use in ZBook 14 models (Gold)	802520-601
Intel Core i5-4200U processor for use with the Windows 8 Standard operating system for use in ZBook 14 models (Gold)	802520-501
Intel Core i5-4200U processor for use with models without the Windows 8 operating system for use in ZBook 14 models (Gold)	802520-001
Intel Core i3-4030U processor for use with the Windows 8 Professional operating system (Gold)	802530-601
Intel Core i3-4030U processor for use with the Windows 8 Standard operating system (Gold)	802530-501
Intel Core i3-4030U processor for use with models without the Windows 8 operating system (Gold)	802530-001
Intel Core i3-4010U processor for use with the Windows 8 Professional operating system (Gold)	802515-601
Intel Core i3-4010U processor for use with the Windows 8 Standard operating system (Gold)	802515-501
Intel Core i3-4010U processor for use with models without the Windows 8 operating system (Gold)	802515-001
System board for use in models with UMA graphics:	
Intel Core i7-4510U processor for use with the Windows 8 Professional operating system (Gold)	802535-601
Intel Core i7-4510U processor for use with the Windows 8 Standard operating system (Gold)	802535-501
Intel Core i7-4510U processor for use with models without the Windows 8 operating system (Gold)	802535-001
Intel Core i7-4500U processor for use with the Windows 8 Professional operating system (Gold)	802523-601
Intel Core i7-4500U processor for use with the Windows 8 Standard operating system (Gold)	802523-501
Intel Core i7-4500U processor for use with models without the Windows 8 operating system (Gold)	802523-001
Intel Core i5-4310U processor for use with the Windows 8 Professional operating system (Gold)	802533-601
Intel Core i5-4310U processor for use with the Windows 8 Standard operating system (Gold)	802533-501
Intel Core i5-4310U processor for use with models without the Windows 8 operating system (Gold)	802533-001
Intel Core i5-4300U processor for use with the Windows 8 Professional operating system (Gold)	802511-601
Intel Core i5-4300U processor for use with the Windows 8 Standard operating system (Gold)	802511-501
Intel Core i5-4300U processor for use with models without the Windows 8 operating system (Gold)	802511-001
Intel Core i5-4210U processor for use with the Windows 8 Professional operating system (Gold)	802531-601
Intel Core i5-4210U processor for use with the Windows 8 Standard operating system (Gold)	802531-501
Intel Core i5-4210U processor for use with models without the Windows 8 operating system (Gold)	802531-001
Intel Core i5-4200U processor for use with the Windows 8 Professional operating system (Gold)	802516-601
Intel Core i5-4200U processor for use with the Windows 8 Standard operating system (Gold)	802516-501
Intel Core i5-4200U processor for use with models without the Windows 8 operating system (Gold)	802516-001
Intel Core i3-4030U processor for use with the Windows 8 Professional operating system (Gold)	802529-601
Intel Core i3-4030U processor for use with the Windows 8 Standard operating system (Gold)	802529-501

Description	Spare part number
Intel Core i3-4030U processor for use with models without the Windows 8 operating system (Gold)	802529-001
Intel Core i3-4010U processor for use with the Windows 8 Professional operating system (Gold)	802514-601
Intel Core i3-4010U processor for use with the Windows 8 Standard operating system (Gold)	802514-501
Intel Core i3-4010U processor for use with models without the Windows 8 operating system (Gold)	802514-001
System board (Gold Conversion Kits) (includes replacement thermal material):	
System board conversion kit for use in models with discrete graphics:	
Intel Core i7-4600U processor for use with the Windows 8 Professional operating system for use in ZBook 14 models (Gold Conversion Kit)	802522-6C1
Intel Core i7-4600U processor for use with the Windows 8 Standard operating system for use in ZBook 14 models (Gold Conversion Kit)	802522-5C1
Intel Core i7-4600U processor for use with models without the Windows 8 operating system for use in ZBook 14 models (Gold Conversion Kit)	802522-0C1
Intel Core i7-4600U processor for use with the Windows 8 Professional operating system (Gold Conversion Kit)	802518-6C1
Intel Core i7-4600U processor for use with the Windows 8 Standard operating system (Gold Conversion Kit)	802518-5C1
Intel Core i7-4600U processor for use with models without the Windows 8 operating system (Gold Conversion Kit)	802518-0C1
Intel Core i7-4510U processor for use with the Windows 8 Professional operating system for use in ZBook 14 models (Gold Conversion Kit)	802528-6C1
Intel Core i7-4510U processor for use with the Windows 8 Standard operating system for use in ZBook 14 models (Gold Conversion Kit)	802528-5C1
Intel Core i7-4510U processor for use with models without the Windows 8 operating system for use in ZBook 14 models (Gold Conversion Kit)	802528-0C1
Intel Core i7-4510U processor for use with the Windows 8 Professional operating system for use in EliteBook 740/840 and 750/850 models (Gold Conversion Kit)	802536-6C1
Intel Core i7-4510U processor for use with the Windows 8 Standard operating system for use in EliteBook 740/840 and 750/850 models (Gold Conversion Kit)	802536-5C1
Intel Core i7-4510U processor for use with models without the Windows 8 operating system for use in EliteBook 740/840 and 750/850 models (Gold Conversion Kit)	802536-0C1
Intel Core i7-4500U processor for use with the Windows 8 Professional operating system for use in EliteBook 740/840 and 750/850 models (Gold Conversion Kit)	802524-6C1
Intel Core i7-4500U processor for use with the Windows 8 Standard operating system for use in EliteBook 740/840 and 750/850 models (Gold Conversion Kit)	802524-5C1
Intel Core i7-4500U processor for use with models without the Windows 8 operating system for use in EliteBook 740/840 and 750/850 models (Gold Conversion Kit)	802524-0C1
Intel Core i7-4500U processor for use with the Windows 8 Professional operating system for use in ZBook 14 models (Gold Conversion Kit)	802525-6C1
Intel Core i7-4500U processor for use with the Windows 8 Standard operating system for use in ZBook 14 models (Gold Conversion Kit)	802525-5C1
Intel Core i7-4500U processor for use with models without the Windows 8 operating system for use in ZBook 14 models (Gold Conversion Kit)	802525-0C1
Intel Core i5-4310U processor for use with the Windows 8 Professional operating system for use in ZBook 14 models (Gold Conversion Kit)	802527-6C1

Description	Spare part number
Intel Core i5-4310U processor for use with the Windows 8 Standard operating system for use in ZBook 14 models (Gold Conversion Kit)	802527-5C1
Intel Core i5-4310U processor for use with models without the Windows 8 operating system for use in ZBook 14 models (Gold Conversion Kit)	802527-0C1
Intel Core i5-4310U processor for use with the Windows 8 Professional operating system for use in EliteBook 740/840 and 750/850 models (Gold Conversion Kit)	802534-6C1
Intel Core i5-4310U processor for use with the Windows 8 Standard operating system for use in EliteBook 740/840 and 750/850 models (Gold Conversion Kit)	802534-5C1
Intel Core i5-4310U processor for use with models without the Windows 8 operating system for use in EliteBook 740/840 and 750/850 models (Gold Conversion Kit)	802534-0C1
Intel Core i5-4300U processor for use with the Windows 8 Professional operating system for use in EliteBook 740/840 and 750/850 models (Gold Conversion Kit)	802512-6C1
Intel Core i5-4300U processor for use with the Windows 8 Standard operating system for use in EliteBook 740/840 and 750/850 models (Gold Conversion Kit)	802512-5C1
Intel Core i5-4300U processor for use with models without the Windows 8 operating system for use in EliteBook 740/840 and 750/850 models (Gold Conversion Kit)	802512-0C1
Intel Core i5-4300U processor for use with the Windows 8 Professional operating system for use in ZBook 14 models (Gold Conversion Kit)	802521-6C1
Intel Core i5-4300U processor for use with the Windows 8 Standard operating system for use in ZBook 14 models (Gold Conversion Kit)	802521-5C1
Intel Core i5-4300U processor for use with models without the Windows 8 operating system for use in ZBook 14 models (Gold Conversion Kit)	802521-0C1
Intel Core i5-4210U processor for use with the Windows 8 Professional operating system for use in ZBook 14 models (Gold Conversion Kit)	802526-6C1
Intel Core i5-4210U processor for use with the Windows 8 Standard operating system for use in ZBook 14 models (Gold Conversion Kit)	802526-5C1
Intel Core i5-4210U processor for use with models without the Windows 8 operating system for use in ZBook 14 models (Gold Conversion Kit)	802526-0C1
Intel Core i5-4210U processor for use with the Windows 8 Professional operating system for use in EliteBook 740/840 and 750/850 models (Gold Conversion Kit)	802532-6C1
Intel Core i5-4210U processor for use with the Windows 8 Standard operating system for use in EliteBook 740/840 and 750/850 models (Gold Conversion Kit)	802532-5C1
Intel Core i5-4210U processor for use with models without the Windows 8 operating system for use in EliteBook 740/840 and 750/850 models (Gold Conversion Kit)	802532-0C1
Intel Core i5-4200U processor for use with the Windows 8 Professional operating system for use in ZBook 14 models (Gold Conversion Kit)	802520-6C1
Intel Core i5-4200U processor for use with the Windows 8 Standard operating system for use in ZBook 14 models (Gold Conversion Kit)	802520-5C1
Intel Core i5-4200U processor for use with models without the Windows 8 operating system for use in ZBook 14 models (Gold Conversion Kit)	802520-0C1
Intel Core i5-4200U processor for use with the Windows 8 Professional operating system (Gold Conversion Kit)	802516-6C1
Intel Core i5-4200U processor for use with the Windows 8 Standard operating system (Gold Conversion Kit)	802516-5C1
Intel Core i5-4200U processor for use with models without the Windows 8 operating system (Gold Conversion Kit)	802516-0C1

Description	Spare part number
Intel Core i3-4030U processor for use with the Windows 8 Professional operating system (Gold Conversion Kit)	802530-6C1
Intel Core i3-4030U processor for use with the Windows 8 Standard operating system (Gold Conversion Kit)	802530-5C1
Intel Core i3-4030U processor for use with models without the Windows 8 operating system (Gold Conversion Kit)	802530-0C1
Intel Core i3-4010U processor for use with the Windows 8 Professional operating system (Gold Conversion Kit)	802514-6C1
Intel Core i3-4010U processor for use with the Windows 8 Standard operating system (Gold Conversion Kit)	802514-5C1
Intel Core i3-4010U processor for use with models without the Windows 8 operating system (Gold Conversion Kit)	802514-0C1
System board for use in models with UMA graphics:	
Intel Core i7-4600U processor for use with the Windows 8 Professional operating system for use in EliteBook 750/850 models (Gold Conversion Kit)	802519-6C1
Intel Core i7-4600U processor for use with the Windows 8 Standard operating system for use in EliteBook 750/850 models (Gold Conversion Kit)	802519-5C1
Intel Core i7-4600U processor for use with models without the Windows 8 operating system for use in EliteBook 750/850 models (Gold Conversion Kit)	802519-0C1
Intel Core i7-4510U processor for use with the Windows 8 Professional operating system (Gold Conversion Kit)	802535-6C1
Intel Core i7-4510U processor for use with the Windows 8 Standard operating system (Gold Conversion Kit)	802535-5C1
Intel Core i7-4510U processor for use with models without the Windows 8 operating system (Gold Conversion Kit)	802535-0C1
Intel Core i7-4500U processor for use with the Windows 8 Professional operating system(Gold Conversion Kit)	802523-6C1
Intel Core i7-4500U processor for use with the Windows 8 Standard operating system(Gold Conversion Kit)	802523-5C1
Intel Core i7-4500U processor for use with models without the Windows 8 operating system(Gold Conversion Kit)	802523-0C1
Intel Core i5-4310U processor for use with the Windows 8 Professional operating system (Gold Conversion Kit)	802533-6C1
Intel Core i5-4310U processor for use with the Windows 8 Standard operating system (Gold Conversion Kit)	802533-5C1
Intel Core i5-4310U processor for use with models without the Windows 8 operating system (Gold Conversion Kit)	802533-0C1
Intel Core i5-4300U processor for use with the Windows 8 Professional operating system (Gold Conversion Kit)	802511-6C1
Intel Core i5-4300U processor for use with the Windows 8 Standard operating system (Gold Conversion Kit)	802511-5C1
Intel Core i5-4300U processor for use with models without the Windows 8 operating system (Gold Conversion Kit)	802511-0C1
Intel Core i5-4210U processor for use with the Windows 8 Professional operating system (Gold Conversion Kit)	802531-6C1
Intel Core i5-4210U processor for use with the Windows 8 Standard operating system (Gold Conversion Kit)	802531-5C1
Intel Core i5-4210U processor for use with models without the Windows 8 operating system (Gold Conversion Kit)	802531-0C1
Intel Core i5-4200U processor for use with the Windows 8 Professional operating system for use in EliteBook 740/840 and 750/850 models (Gold Conversion Kit)	802517-6C1
Intel Core i5-4200U processor for use with the Windows 8 Standard operating system for use in EliteBook 740/840 and 750/850 models (Gold Conversion Kit)	802517-5C1
Intel Core i5-4200U processor for use with models without the Windows 8 operating system for use in EliteBook 740/840 and 750/850 models (Gold Conversion Kit)	802517-0C1
Intel Core i3-4030U processor for use with the Windows 8 Professional operating system (Gold Conversion Kit)	802529-6C1
Intel Core i3-4030U processor for use with the Windows 8 Standard operating system (Gold Conversion Kit)	802529-5C1

Description	Spare part number
Intel Core i3-4030U processor for use with models without the Windows 8 operating system (Gold Conversion Kit)	802529-0C1
Intel Core i3-4010U processor for use with the Windows 8 Professional operating system (Gold Conversion Kit)	802515-6C1
Intel Core i3-4010U processor for use with the Windows 8 Standard operating system (Gold Conversion Kit)	802515-5C1
Intel Core i3-4010U processor for use with models without the Windows 8 operating system (Gold Conversion Kit)	802515-0C1

Before removing the system board, follow these steps:

1. Turn off the computer. If you are unsure whether the computer is off or in Hibernation, turn the computer on, and then shut it down through the operating system.
2. Disconnect the power from the computer by unplugging the power cord from the computer.
3. Disconnect all external devices from the computer.
4. Remove the following components:
 - a. Service cover (see [Service cover on page 57](#))
 - b. Battery (see [Battery on page 59](#))
 - c. Hard drive (see [Hard drive on page 60](#))
 - d. Fan (see [Fan on page 85](#))
 - e. Keyboard (see [Keyboard on page 71](#))
 - f. Base enclosure (see [Base enclosure on page 79](#))

When replacing the system board, be sure that the following components are removed from the defective system board and installed on the replacement system board:

- Memory modules (see [Memory module on page 65](#))
- Heat sink (see [Heat sink on page 88](#))



NOTE: You do not have to remove the heat sink to remove the system board.

- Solid-state drive (see [Solid-state drive \(SSD\) on page 62](#))
- WLAN module (see [WLAN module on page 69](#))
- WWAN module (see [WWAN module on page 67](#))

Remove the system board:

1. Position the computer upright and open as far as possible.

2. Release the ZIF connector **(1)** to which the fingerprint reader cable is connected, and then disconnect the fingerprint reader cable **(2)** from the system board.

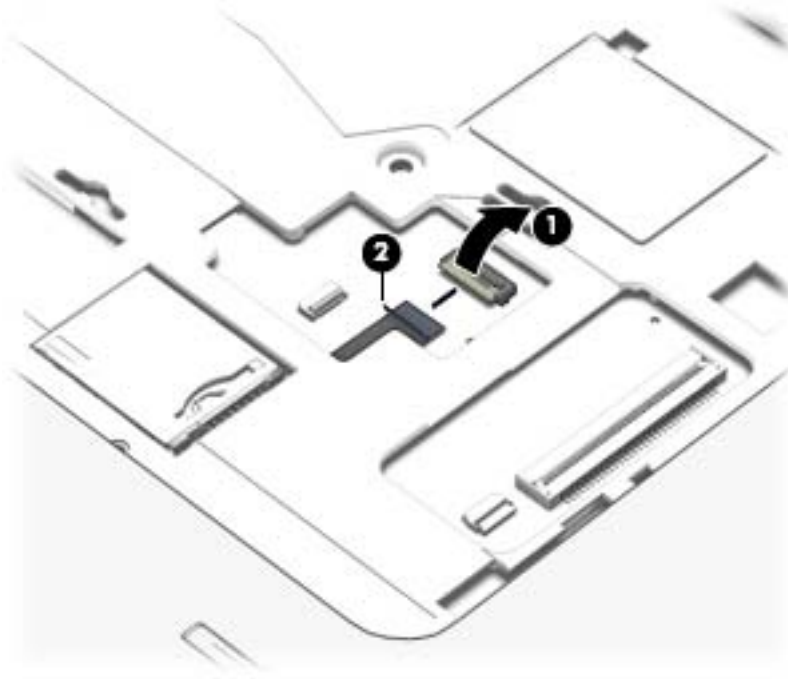

3. Close the computer and position it upside down.
4. Disconnect the smart card reader cable **(1)** from the smart card reader.
5. Disconnect the VGA/USB board cable **(2)** from the system board.
6. Disconnect the power button board cable **(3)** from the system board.
7. Release the display panel cable from the routing channel **(4)** attached to the system board, and then disconnect the display panel cable **(5)** from the system board.
8. Disconnect the speaker cable **(6)** from the system board.

9. Note the routing location of the antenna cables (7) when removing them.

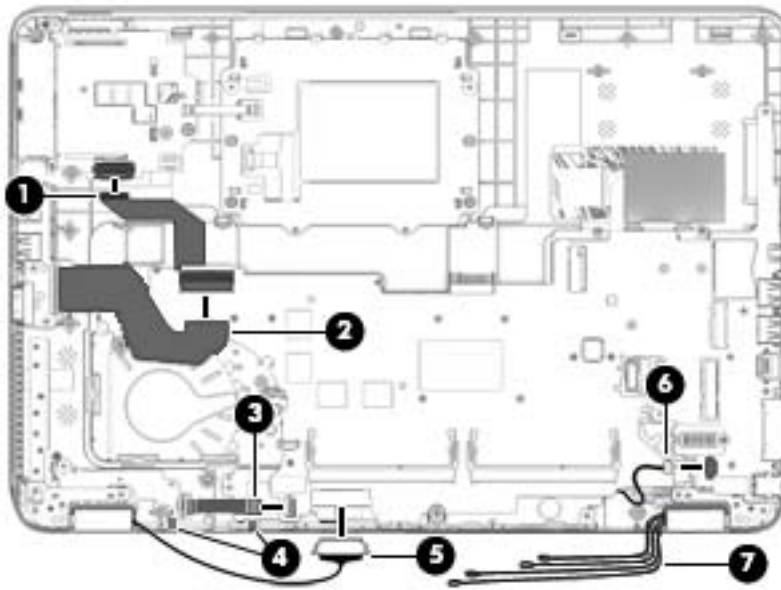

10. Remove the three Phillips PM2.5×5.0 screws that secure the system board to the top cover.

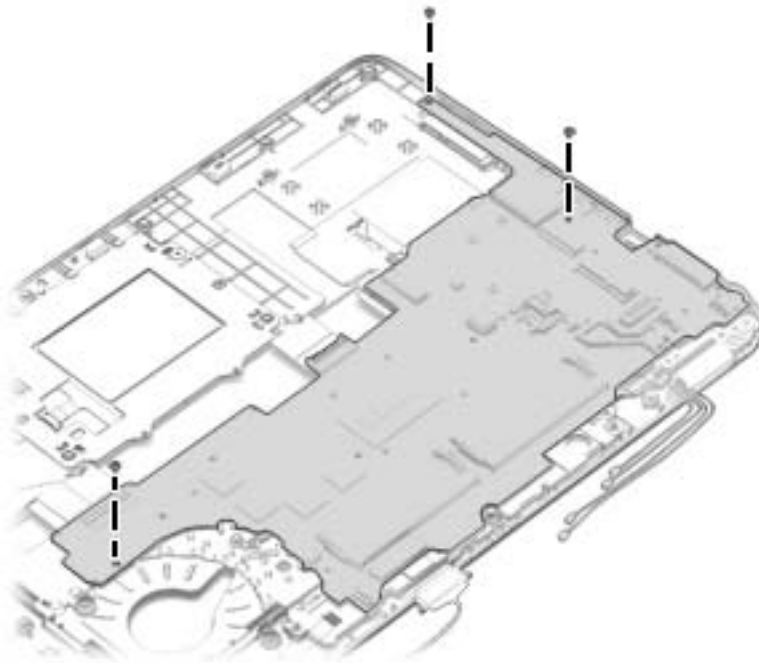

11. Lift the left side of the system board (1).

12. Remove the system board **(2)** by sliding it up and to the left at an angle.

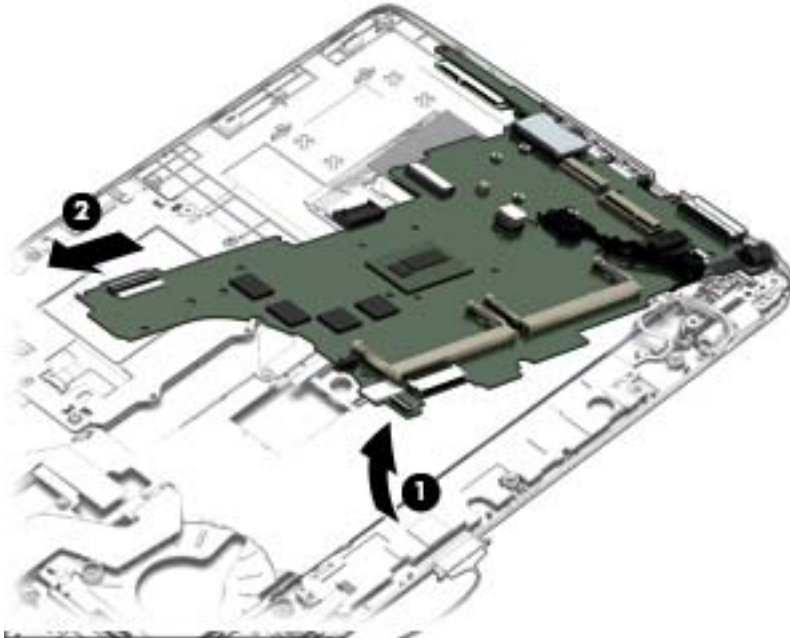

Reverse this procedure to install the system board.

Speaker assembly

Description	Spare part number
Speaker assembly (includes cable)	730798-001

Before removing the speaker assembly, follow these steps:

1. Turn off the computer. If you are unsure whether the computer is off or in Hibernation, turn the computer on, and then shut it down through the operating system.
2. Disconnect the power from the computer by unplugging the power cord from the computer.
3. Disconnect all external devices from the computer.
4. Remove the battery (see [Battery on page 59](#)), and then remove the following components:
 - a. Service cover (see [Service cover on page 57](#))
 - b. Battery (see [Battery on page 59](#))
 - c. Hard drive (see [Hard drive on page 60](#))
 - d. WWAN module (see [WWAN module on page 67](#))
 - e. WLAN module (see [WLAN module on page 69](#))
 - f. Fan (see [Fan on page 85](#))
 - g. Keyboard (see [Keyboard on page 71](#))
 - h. Base enclosure (see [Base enclosure on page 79](#))
 - i. System board (see [System board on page 96](#))

Remove the speaker assembly:

1. Position the top cover upside down.
2. Remove the two Phillips PM2.0×3.0 screws **(1)** that secure the speaker assembly to the base enclosure.

3. Remove the speaker assembly **(2)** from the top cover.

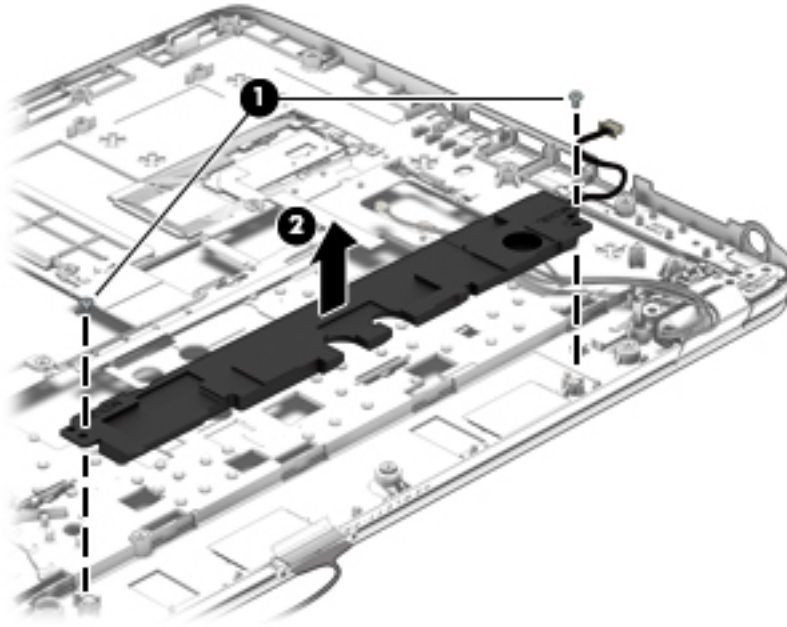

Reverse this procedure to install the speaker assembly.

Display assembly

 **NOTE:** HP EliteBook 840 models offer both touch and non-touch displays. Non-touch displays are spared at the subcomponent level only. Touch displays are only spared as a whole (touch display components are not spared).

In non-touch models, you can remove the raw display panel with the display assembly still connected to the computer. For more information, see [Display panel \(non-touch\) on page 75](#).

The following section shows how to remove the raw display panel without removing the display assembly from the computer. See the display section later in this chapter to remove internal components that require that you remove the display assembly.

Description	Spare part number
Display assembly, touch screen (whole assembly)	
Display assembly, 14-inch, HD+, for use in HP EliteBook 740/840 models	737735-001
Display assembly, 14-inch, HD+, for use in HP ZBook 14 models	739848-001
Display assembly, 15-inch, HD, for use in HP EliteBook 750/850 models	766680-001
Display enclosure (non-touch models) (includes 4 transceivers with antennas)	
Display bezel for use in HP EliteBook 740/840 models	730949-001
Display bezel for use in HP ZBook 14 models	730948-001
Display bezel for use in HP EliteBook 850 models	730811-001

Before removing the display assembly, follow these steps:

1. Turn off the computer. If you are unsure whether the computer is off or in Hibernation, turn the computer on, and then shut it down through the operating system.
2. Disconnect the power from the computer by unplugging the power cord from the computer.
3. Disconnect all external devices from the computer.
4. Remove the following components:
 - a. Service cover (see [Service cover on page 57](#))
 - b. Battery (see [Battery on page 59](#))
 - c. Fan (see [Fan on page 85](#))
 - d. Keyboard (see [Keyboard on page 71](#))
 - e. Base enclosure (see [Base enclosure on page 79](#))

Remove the display assembly:

1. Disconnect the display panel cable **(1)** from the system board.

2. Release the wireless antenna cables **(2)** from the routing channel attached to the system board.

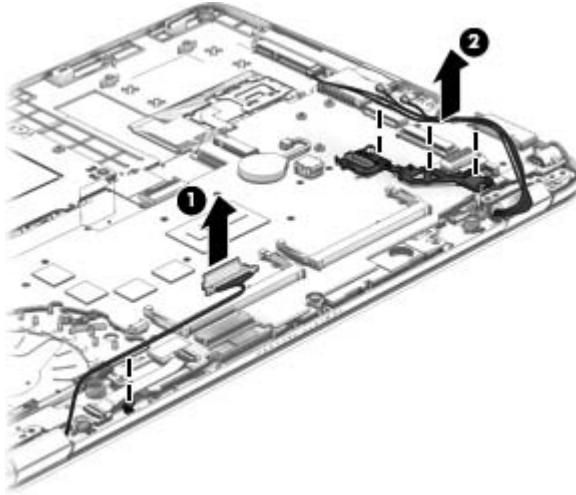

3. Remove the four Torx TM2.5×6.0 screws **(1)** that secure the display panel to the computer.
4. Rotate the display hinges upward to an angle **(2)** until the top cover is free for removal.
5. Separate the display from the top cover **(3)**.

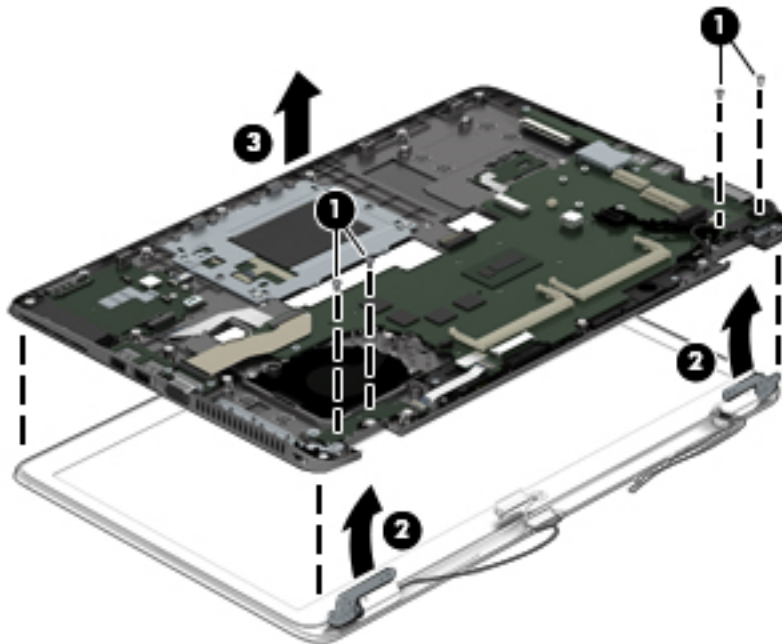

6. If you need to remove the bezel, lift to disengage the bezel on the bottom **(1)**, left and right sides **(2)**, and top **(3)**.

7. Remove the bezel from the display assembly **(4)**.

The display bezel is available using spare part number 730952-001 for HP EliteBook 840 models, 784451-001 for HP EliteBook 740 models, 730953-001 for HP ZBook 14 models, 730814-001 for HP EliteBook 850 models, and 784478-001 for HP EliteBook 750 models.

 **NOTE:** In these steps, the display assembly will not be connected to the computer as shown in the illustration.

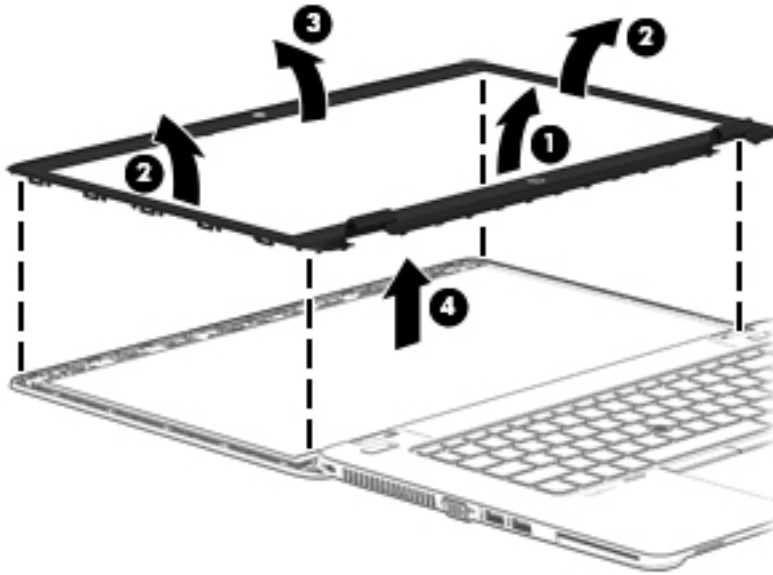

8. If you need to remove the raw display panel, remove the four Phillips PM2.0×3.0 screws **(1)** that secure the display panel to the display enclosure.

9. Lift and rotate the panel onto the computer **(2)**.

The raw display panel is available using the following spare part numbers:

- 737657-001: (35.6-cm) 14.0-in, HD (1366×768)
- 737658-001: (35.6-cm) 14.0-in, HD+ (1920×1080)
- 737659-001: (35.6-cm) 14.0-in, FHD (1920×1080)
- 733684-001: (39.6-cm) 15.6-in, HD (1368×768)
- 733685-001: (39.6-cm) 15.6-in, FHD (1920×1080)

 **NOTE:** In these steps, the display assembly will not be connected to the computer as shown in the illustration.

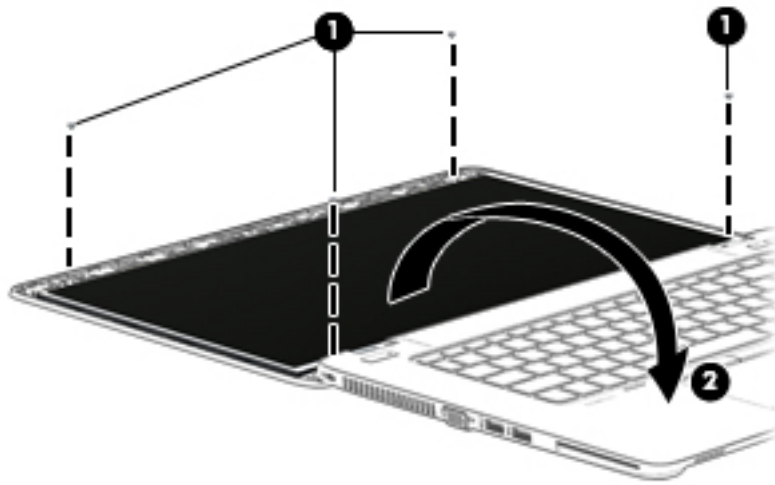

10. Lift the tape that secures the display cable to the display panel (1), and the disconnect the display cable from the panel (2).

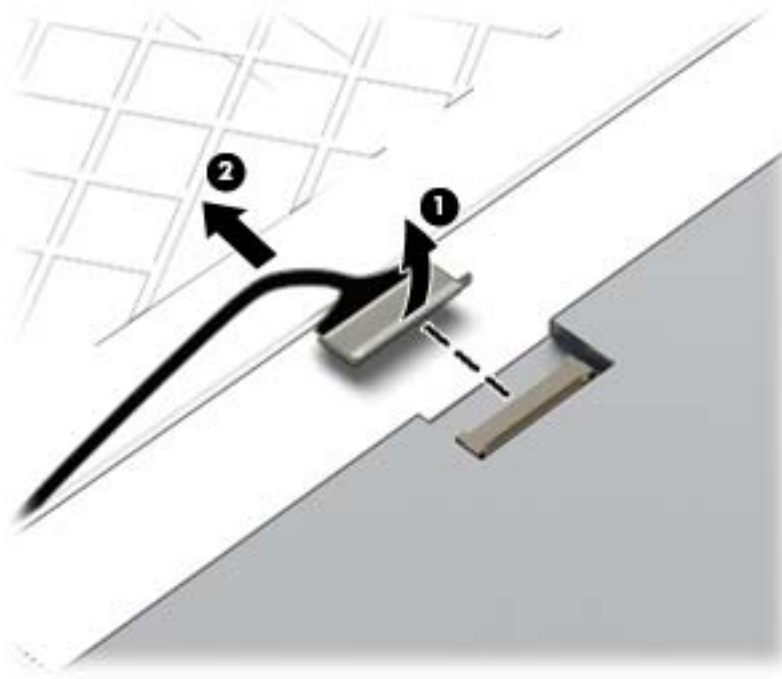

11. Lift the display panel from the display enclosure.

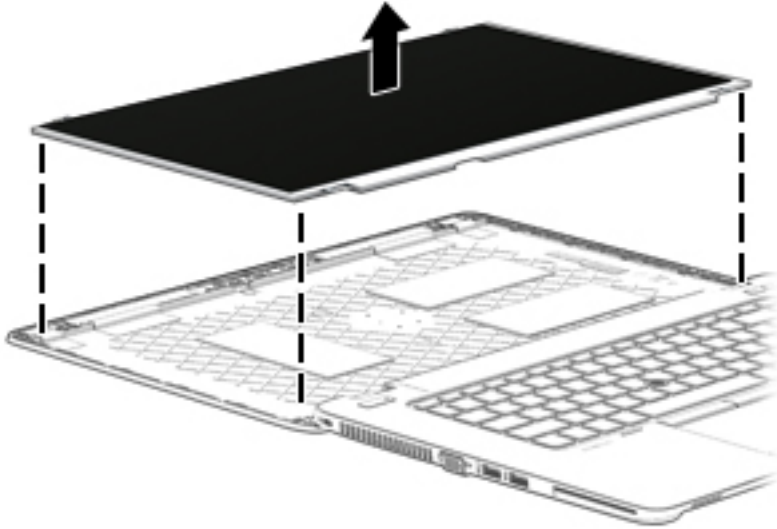

12. If you need to replace the webcam/microphone module:

The webcam is available using spare part number 730542-001. The microphone module is available using spare part number 730795-001.

- a. Release the tape that secures the webcam cable to the module **(1)**.
- b. Disconnect the cable **(2)** from the module.

⚠ CAUTION: Handle the module with caution. The module has a thin profile and is susceptible to damage when not handled carefully.

- c. Remove the module **(3)** from the display enclosure. (The module is attached to the display enclosure with double-sided tape.)

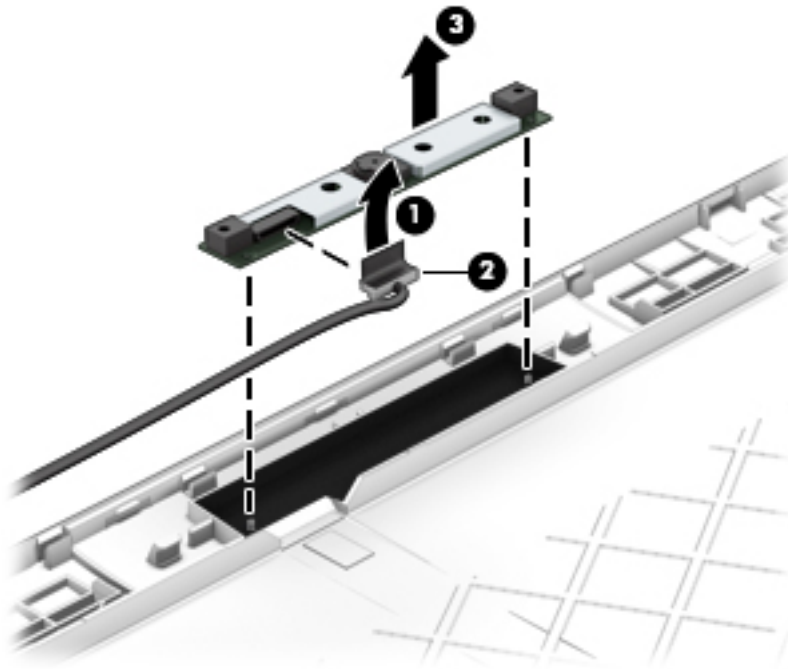

13. If you need to remove the display hinges, remove the six broadhead Phillips PM 2.0×2.0 screws (1), and then lift the hinges from the display enclosure (2).

Display hinges are available using spare part number 730957-001 for HP EliteBook 740/840 models, 737660-001 for HP ZBook 14 models, and 730819-001 for HP EliteBook 750/850 models.

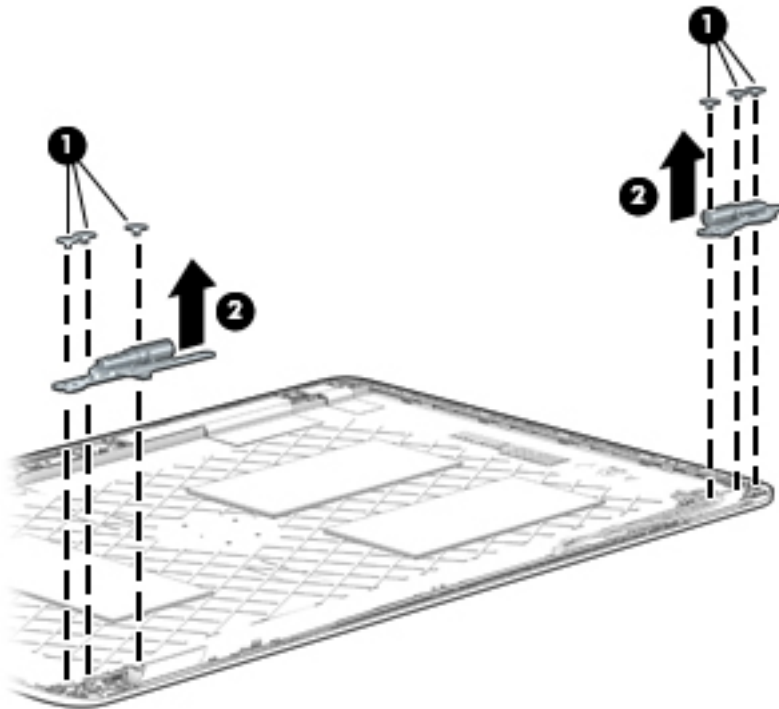

14. If you need to remove the display cable, lift the cable straight up and out of the display enclosure. Use the following image to properly route the cable.

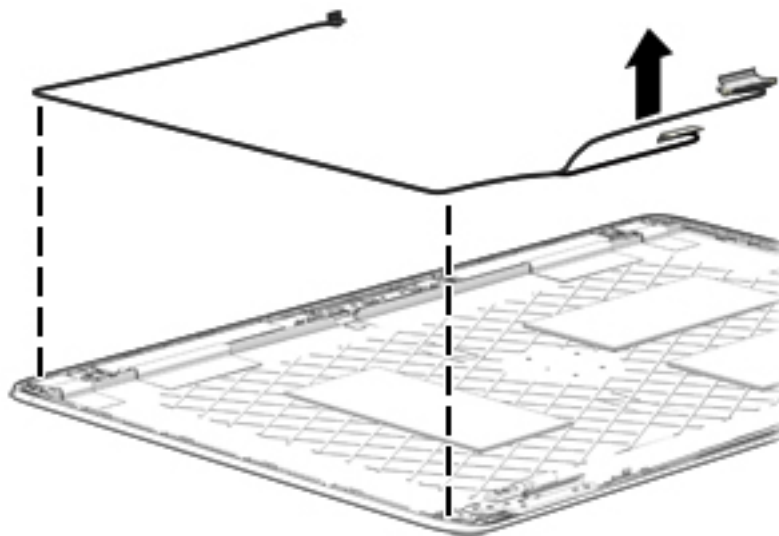

15. If you need to replace the WLAN antenna cables and transceivers:
 - a. Release the antenna cables from the clips (1) and routing channel built into the display enclosure.

- b. Detach the WLAN antennas and transceivers **(2)** and the WWAN antennas and transceivers **(3)** from the display enclosure.

The antenna cables and transceivers are included in the Cable Kits, spare part numbers 730947-001 (for use only on HP EliteBook 740/840/HP ZBook 14 models) and 736678-001 (for use only on HP EliteBook 750/850 models).

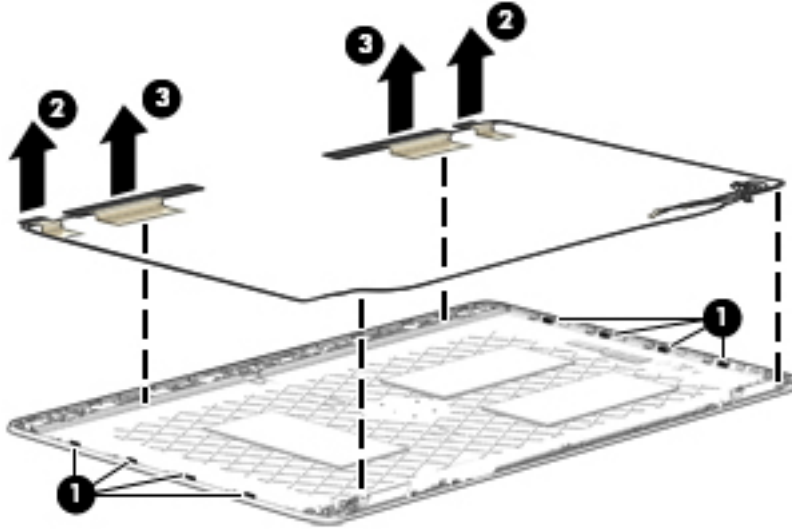

Reverse this procedure to reassemble and install the display assembly.

7 Computer Setup (BIOS), MultiBoot, and System Diagnostics in Windows 8

Using Computer Setup

Computer Setup, or Basic Input/Output System (BIOS), controls communication between all the input and output devices on the system (such as disk drives, display, keyboard, mouse, and printer). Computer Setup includes settings for the types of devices installed, the startup sequence of the computer, and the amount of system and extended memory.

 **NOTE:** Use extreme care when making changes in Computer Setup. Errors can prevent the computer from operating properly.

Starting Computer Setup

 **NOTE:** An external keyboard or mouse connected to a USB port can be used with Computer Setup only if USB legacy support is enabled.

To start Computer Setup, follow these steps:

1. Turn on or restart the computer, and then press **esc** while the “Press the ESC key for Startup Menu” message is displayed at the bottom of the screen.
2. Press **f10** to enter Computer Setup.

Navigating and selecting in Computer Setup

To navigate and select in Computer Setup, follow these steps:

1. Turn on or restart the computer, and then press **esc** while the “Press the ESC key for Startup Menu” message is displayed at the bottom of the screen.

 **NOTE:** You can use either a pointing device (TouchPad, pointing stick, or USB mouse) or the keyboard to navigate and make selections in Computer Setup.

2. Press **f10** to enter Computer Setup.
 - To select a menu or a menu item, use the **tab** key and the keyboard arrow keys and then press **enter**, or use a pointing device to click the item.
 - To scroll up and down, click the up arrow or the down arrow in the upper-right corner of the screen, or use the up arrow key or the down arrow key on the keyboard.
 - To close open dialog boxes and return to the main Computer Setup screen, press **esc**, and then follow the on-screen instructions.

To exit Computer Setup menus, choose one of the following methods:

- To exit Computer Setup menus without saving your changes:
Click the **Exit** icon in the lower-right corner of the screen, and then follow the on-screen instructions.

– or –

Use the **tab** key and the arrow keys to select **File > Ignore Changes and Exit**, and then press **enter**.

- To save your changes and exit Computer Setup menus:

Click the **Save** icon in the lower-right corner of the screen, and then follow the on-screen instructions.

– or –

Use the **tab** key and the arrow keys to select **File > Save Changes and Exit**, and then press **enter**.

Your changes go into effect when the computer restarts.

Restoring factory settings in Computer Setup



NOTE: Restoring defaults will not change the hard drive mode.

To return all settings in Computer Setup to the values that were set at the factory, follow these steps:

1. Turn on or restart the computer, and then press **esc** while the “Press the ESC key for Startup Menu” message is displayed at the bottom of the screen.
2. Press **f10** to enter Computer Setup.
3. Use a pointing device or the arrow keys to select **File > Restore Defaults**.
4. Follow the on-screen instructions.
5. To save your changes and exit, click the **Save** icon in the lower-right corner of the screen, and then follow the on-screen instructions.

– or –

Use the arrow keys to select **File > Save Changes and Exit**, and then press **enter**.

Your changes go into effect when the computer restarts.



NOTE: Your password settings and security settings are not changed when you restore the factory settings.

Updating the BIOS

Updated versions of the BIOS may be available on the HP website.

Most BIOS updates on the HP website are packaged in compressed files called *SoftPaqs*.

Some download packages contain a file named *Readme.txt*, which contains information regarding installing and troubleshooting the file.

Determining the BIOS version

To determine whether available BIOS updates contain later BIOS versions than those currently installed on the computer, you need to know the version of the system BIOS currently installed.

BIOS version information (also known as *ROM date* and *System BIOS*) can be displayed by pressing **fn+esc** (if you are already in Windows) or by using Computer Setup.

1. Start Computer Setup.
2. Use a pointing device or the arrow keys to select **File > System Information**.
3. To exit Computer Setup without saving your changes, click the **Exit** icon in the lower-right corner of the screen, and then follow the on-screen instructions.

– or –

Use the **tab** key and the arrow keys to select **File > Ignore Changes and Exit**, and then press **enter**.

Downloading a BIOS update

 **CAUTION:** To reduce the risk of damage to the computer or an unsuccessful installation, download and install a BIOS update only when the computer is connected to reliable external power using the AC adapter. Do not download or install a BIOS update while the computer is running on battery power, docked in an optional docking device, or connected to an optional power source. During the download and installation, follow these instructions:

Do not disconnect power on the computer by unplugging the power cord from the AC outlet.

Do not shut down the computer or initiate Sleep.

Do not insert, remove, connect, or disconnect any device, cable, or cord.

1. From the Start screen, select the HP Support Assistant app.
2. Select **Updates and tune-ups**, and then select **Check for HP updates now**.
3. At the download area, follow these steps:
 - a. Identify the most recent BIOS update and compare it to the BIOS version currently installed on your computer. Make a note of the date, name, or other identifier. You may need this information to locate the update later, after it has been downloaded to your hard drive.
 - b. Follow the on-screen instructions to download your selection to the hard drive.

If the update is more recent than your BIOS, make a note of the path to the location on your hard drive where the BIOS update is downloaded. You will need to access this path when you are ready to install the update.

 **NOTE:** If you connect your computer to a network, consult the network administrator before installing any software updates, especially system BIOS updates.

BIOS installation procedures vary. Follow any instructions that are displayed on the screen after the download is complete. If no instructions are displayed, follow these steps:

1. From the Start screen, type **e**, and then click **File Explorer**.
2. Click your hard drive designation. The hard drive designation is typically Local Disk (C:).
3. Using the hard drive path you recorded earlier, open the folder on your hard drive that contains the update.
4. Double-click the file that has an .exe extension (for example, *filename.exe*).

The BIOS installation begins.
5. Complete the installation by following the on-screen instructions.

 **NOTE:** After a message on the screen reports a successful installation, you can delete the downloaded file from your hard drive.

HP Sure Start

Select Intel-based 2013 HP Business Notebook PCs offer HP Sure Start, which provides hardware-based assurance of the following:

- HP-approved firmware is running on the HP Embedded Controller (EC) – EC Options in BIOS found under “BIOS Integrity Checking”
- An HP-approved BIOS is running on the host processor

HP Sure Start verifies the integrity of critical, non-executable platform data residing in the main flash and provides selfhealing mechanisms to restore any code or critical platform data that has been lost or is corrupted within the flash.

In conjunction with BIOS support, code running on the EC verifies the integrity of the following:

- Subset of BIOS contents including the boot block portion and machine-unique data
- Entire descriptor region
- Entire Network Controller Configuration

The EC is responsible for power control/power cycle, thermal monitor/fan control, many LEDs, and PS2 keyboard and mouse.

Using MultiBoot

About the boot device order

As the computer starts, the system attempts to boot from enabled devices. The MultiBoot utility, which is enabled at the factory, controls the order in which the system selects a boot device. Boot devices can include optical drives, diskette drives, a network interface card (NIC), hard drives, and USB devices. Boot devices contain bootable media or files that the computer needs to start and operate properly.



NOTE: Some boot devices must be enabled in Computer Setup before they can be included in the boot order.

You can change the order in which the computer searches for a boot device by changing the boot order in Computer Setup. You can also press **esc** while the “Press the ESC key for Startup Menu” message is displayed at the bottom of the screen, and then press **f9**. Pressing **f9** displays a menu that shows the current boot devices and allows you to select a boot device. Or, you can use MultiBoot Express to set the computer to prompt you for a boot location each time the computer turns on or restarts.

Choosing MultiBoot preferences

You can use MultiBoot in the following ways:

- To set a new boot order that the computer uses each time it is turned on, by changing the boot order in Computer Setup.
- To dynamically choose the boot device, by pressing **esc** while the “Press the ESC key for Startup Menu” message is displayed at the bottom of the screen, and then pressing **f9** to enter the Boot Device Options menu.
- To use MultiBoot Express to set variable boot orders. This feature prompts you for a boot device each time the computer is turned on or restarted.

Setting a new boot order in Computer Setup

To start Computer Setup and set a boot device order that the computer uses each time it is turned on or restarted, follow these steps:

1. Turn on or restart the computer, and then press **esc** while the “Press the ESC key for Startup Menu” message is displayed at the bottom of the screen.
2. Press **f10** to enter Computer Setup.
3. Use a pointing device or the arrow keys to select the **Legacy Boot Order** list, and then press **enter**.
4. To move the device up in the boot order, use a pointing device to click the up arrow, or press the **+** key.
– or –
To move the device down in the boot order, use a pointing device to click the down arrow, or press the **-** key.
5. To save your changes and exit Computer Setup, click the **Save** icon in the lower-left corner of the screen, and then follow the on-screen instructions.
– or –
Use the arrow keys to select **File > Save Changes and Exit**, and then press **enter**.

Dynamically choosing a boot device using the f9 prompt

To dynamically choose a boot device for the current startup sequence, follow these steps:

1. Open the Select Boot Device menu by turning on or restarting the computer, and then pressing **esc** while the “Press the ESC key for Startup Menu” message is displayed at the bottom of the screen.
2. Press **f9**.
3. Use a pointing device or the arrow keys to select a boot device, then press **enter**.

Setting a MultiBoot Express prompt

To start Computer Setup and set the computer to display the MultiBoot startup location menu each time the computer is started or restarted, follow these steps:

1. Turn on or restart the computer, and then press **esc** while the “Press the ESC key for Startup Menu” message is displayed at the bottom of the screen.
2. Press **f10** to enter Computer Setup.
3. Use a pointing device or the arrow keys to select **System Configuration > Boot Options**, and then press **enter**.
4. In the **MultiBoot Express Popup Delay (Sec)** field, enter the length of time in seconds that you want the computer to display the startup location menu before it defaults to the current MultiBoot setting. (When 0 is selected, the Express Boot startup location menu is not displayed.)
5. To save your changes and exit Computer Setup, click the **Save** icon in the lower-left corner of the screen, and then follow the on-screen instructions.
– or –
Use the arrow keys to select **File > Save Changes and Exit**, and then press **enter**.

Your changes go into effect when the computer restarts.

Entering MultiBoot Express preferences

When the Express Boot menu is displayed during startup, you have the following choices:

- To specify a boot device from the Express Boot menu, select your preference within the allotted time, and then press **enter**.
- To prevent the computer from defaulting to the current MultiBoot setting, press any key before the allotted time expires. The computer will not start until you select a boot device and press **enter**.
- To allow the computer to start according to the current MultiBoot settings, wait for the allotted time to expire.

Using HP PC Hardware Diagnostics (UEFI) (select models only)

HP PC Hardware Diagnostics is a Unified Extensible Firmware Interface (UEFI) that allows you to run diagnostic tests to determine if the computer hardware is functioning properly. The tool runs outside of the operating system to isolate hardware failures from issues that may be caused by the operating system or other software components.

To start HP PC Hardware Diagnostics UEFI:

1. Turn on or restart the computer, quickly press **esc**, and then press **f2**.

After pressing **f2**, the BIOS searches three places for the HP PC Hardware Diagnostics (UEFI) tools in the following order:

- a. Connected USB drive



NOTE: To download the HP PC Hardware Diagnostics (UEFI) tool to a USB drive, see [Downloading HP PC Hardware Diagnostics \(UEFI\) to a USB device on page 120](#).

- b. Hard drive

- c. BIOS

2. Click the type of diagnostic test you want to run, and then follow the on-screen instructions.



NOTE: If you need to stop a diagnostic test while it is running, press **esc**.

Downloading HP PC Hardware Diagnostics (UEFI) to a USB device



NOTE: The HP PC Hardware Diagnostics (UEFI) download instructions are provided in English only.

1. Go to <http://www.hp.com>.
2. Click **Support & Drivers**, and then click the **Drivers & Software** tab.
3. Enter the product name in the text box, and then click **Search**.
4. Select your computer model, and then select your operating system.
5. In the Diagnostic section, click **HP UEFI Support Environment**.

– or –

Click **Download**, and then select **Run**.

8 Computer Setup (BIOS) and HP PC Hardware Diagnostics (UEFI) in Windows 7

Using Computer Setup

Computer Setup, or Basic Input/Output System (BIOS), controls communication between all the input and output devices on the system (such as disk drives, display, keyboard, mouse, and printer). Computer Setup includes settings for the types of devices installed, the startup sequence of the computer, and the amount of system and extended memory.

 **NOTE:** Use extreme care when making changes in Computer Setup. Errors can prevent the computer from operating properly.

Starting Computer Setup

 **NOTE:** An external keyboard or mouse connected to a USB port can be used with Computer Setup only if USB legacy support is enabled.

To start Computer Setup, follow these steps:

1. Turn on or restart the computer, and then press **esc** while the “Press the ESC key for Startup Menu” message is displayed at the bottom of the screen.
2. Press **f10** to enter Computer Setup.

Navigating and selecting in Computer Setup

To navigate and select in Computer Setup, follow these steps:

1. Turn on or restart the computer, and then press **esc** while the “Press the ESC key for Startup Menu” message is displayed at the bottom of the screen.

 **NOTE:** You can use either a pointing device (TouchPad, pointing stick, or USB mouse) or the keyboard to navigate and make selections in Computer Setup.

2. Press **f10** to enter Computer Setup.
 - To select a menu or a menu item, use the **tab** key and the keyboard arrow keys and then press **enter**, or use a pointing device to click the item.
 - To scroll up and down, click the up arrow or the down arrow in the upper-right corner of the screen, or use the up arrow key or the down arrow key on the keyboard.
 - To close open dialog boxes and return to the main Computer Setup screen, press **esc**, and then follow the on-screen instructions.

To exit Computer Setup menus, choose one of the following methods:

- To exit Computer Setup menus without saving your changes:
Click the **Exit** icon in the lower-right corner of the screen, and then follow the on-screen instructions.

– or –

Use the **tab** key and the arrow keys to select **File > Ignore Changes and Exit**, and then press **enter**.

- To save your changes and exit Computer Setup menus:

Click the **Save** icon in the lower-right corner of the screen, and then follow the on-screen instructions.

– or –

Use the **tab** key and the arrow keys to select **File > Save Changes and Exit**, and then press **enter**.

Your changes go into effect when the computer restarts.

Restoring factory settings in Computer Setup



NOTE: Restoring defaults will not change the hard drive mode.

To return all settings in Computer Setup to the values that were set at the factory, follow these steps:

1. Turn on or restart the computer, and then press **esc** while the “Press the ESC key for Startup Menu” message is displayed at the bottom of the screen.
2. Press **f10** to enter Computer Setup.
3. Use a pointing device or the arrow keys to select **File > Restore Defaults**.
4. Follow the on-screen instructions.
5. To save your changes and exit, click the **Save** icon in the lower-right corner of the screen, and then follow the on-screen instructions.

– or –

Use the arrow keys to select **File > Save Changes and Exit**, and then press **enter**.

Your changes go into effect when the computer restarts.



NOTE: Your password settings and security settings are not changed when you restore the factory settings.

Updating the BIOS

Updated versions of the BIOS may be available on the HP website.

Most BIOS updates on the HP website are packaged in compressed files called *SoftPaqs*.

Some download packages contain a file named *Readme.txt*, which contains information regarding installing and troubleshooting the file.

Determining the BIOS version

To determine whether available BIOS updates contain later BIOS versions than those currently installed on the computer, you need to know the version of the system BIOS currently installed.

BIOS version information (also known as *ROM date* and *System BIOS*) can be displayed by pressing **fn+esc** (if you are already in Windows) or by using Computer Setup.

1. Start Computer Setup.
2. Use a pointing device or the arrow keys to select **File > System Information**.
3. To exit Computer Setup without saving your changes, click the **Exit** icon in the lower-right corner of the screen, and then follow the on-screen instructions.

– or –

Use the **tab** key and the arrow keys to select **File > Ignore Changes and Exit**, and then press **enter**.

Downloading a BIOS update

 **CAUTION:** To reduce the risk of damage to the computer or an unsuccessful installation, download and install a BIOS update only when the computer is connected to reliable external power using the AC adapter. Do not download or install a BIOS update while the computer is running on battery power, docked in an optional docking device, or connected to an optional power source. During the download and installation, follow these instructions:

Do not disconnect power on the computer by unplugging the power cord from the AC outlet.

Do not shut down the computer or initiate Sleep.

Do not insert, remove, connect, or disconnect any device, cable, or cord.

1. Access Help and Support by selecting **Start > Help and Support**.
2. Select **Updates and tune-ups**, and then select **Check for HP updates now**.
3. At the download area, follow these steps:
 - a. Identify the most recent BIOS update and compare it to the BIOS version currently installed on your computer. Make a note of the date, name, or other identifier. You may need this information to locate the update later, after it has been downloaded to your hard drive.
 - b. Follow the on-screen instructions to download your selection to the hard drive.

If the update is more recent than your BIOS, make a note of the path to the location on your hard drive where the BIOS update is downloaded. You will need to access this path when you are ready to install the update.

 **NOTE:** If you connect your computer to a network, consult the network administrator before installing any software updates, especially system BIOS updates.

BIOS installation procedures vary. Follow any instructions that are displayed on the screen after the download is complete. If no instructions are displayed, follow these steps:

1. Select **Start > Computer**.
2. Click your hard drive designation. The hard drive designation is typically Local Disk (C:).
3. Using the hard drive path you recorded earlier, open the folder on your hard drive that contains the update.
4. Double-click the file that has an .exe extension (for example, *filename.exe*).

The BIOS installation begins.
5. Complete the installation by following the on-screen instructions.

 **NOTE:** After a message on the screen reports a successful installation, you can delete the downloaded file from your hard drive.

HP Sure Start

Select Intel-based 2013 HP Business Notebook PCs offer HP Sure Start, which provides hardware-based assurance of the following:

- HP-approved firmware is running on the HP Embedded Controller (EC) – EC Options in BIOS found under “BIOS Integrity Checking”
- An HP-approved BIOS is running on the host processor

HP Sure Start verifies the integrity of critical, non-executable platform data residing in the main flash and provides selfhealing mechanisms to restore any code or critical platform data that has been lost or is corrupted within the flash.

In conjunction with BIOS support, code running on the EC verifies the integrity of the following:

- Subset of BIOS contents including the boot block portion and machine-unique data
- Entire descriptor region
- Entire Network Controller Configuration

The EC is responsible for power control/power cycle, thermal monitor/fan control, many LEDs, and PS2 keyboard and mouse.

Using MultiBoot

About the boot device order

As the computer starts, the system attempts to boot from enabled devices. The MultiBoot utility, which is enabled at the factory, controls the order in which the system selects a boot device. Boot devices can include optical drives, diskette drives, a network interface card (NIC), hard drives, and USB devices. Boot devices contain bootable media or files that the computer needs to start and operate properly.



NOTE: Some boot devices must be enabled in Computer Setup before they can be included in the boot order.

You can change the order in which the computer searches for a boot device by changing the boot order in Computer Setup. You can also press **esc** while the “Press the ESC key for Startup Menu” message is displayed at the bottom of the screen, and then press **f9**. Pressing **f9** displays a menu that shows the current boot devices and allows you to select a boot device. Or, you can use MultiBoot Express to set the computer to prompt you for a boot location each time the computer turns on or restarts.

Choosing MultiBoot preferences

You can use MultiBoot in the following ways:

- To set a new boot order that the computer uses each time it is turned on, by changing the boot order in Computer Setup.
- To dynamically choose the boot device, by pressing **esc** while the “Press the ESC key for Startup Menu” message is displayed at the bottom of the screen, and then pressing **f9** to enter the Boot Device Options menu.
- To use MultiBoot Express to set variable boot orders. This feature prompts you for a boot device each time the computer is turned on or restarted.

Setting a new boot order in Computer Setup

To start Computer Setup and set a boot device order that the computer uses each time it is turned on or restarted, follow these steps:

1. Turn on or restart the computer, and then press **esc** while the “Press the ESC key for Startup Menu” message is displayed at the bottom of the screen.
2. Press **f10** to enter Computer Setup.
3. Use a pointing device or the arrow keys to select the **Legacy Boot Order** list, and then press **enter**.
4. To move the device up in the boot order, use a pointing device to click the up arrow, or press the **+** key.
– or –
To move the device down in the boot order, use a pointing device to click the down arrow, or press the **-** key.
5. To save your changes and exit Computer Setup, click the **Save** icon in the lower-left corner of the screen, and then follow the on-screen instructions.
– or –
Use the arrow keys to select **File > Save Changes and Exit**, and then press **enter**.

Dynamically choosing a boot device using the f9 prompt

To dynamically choose a boot device for the current startup sequence, follow these steps:

1. Open the Select Boot Device menu by turning on or restarting the computer, and then pressing **esc** while the “Press the ESC key for Startup Menu” message is displayed at the bottom of the screen.
2. Press **f9**.
3. Use a pointing device or the arrow keys to select a boot device, then press **enter**.

Setting a MultiBoot Express prompt

To start Computer Setup and set the computer to display the MultiBoot startup location menu each time the computer is started or restarted, follow these steps:

1. Turn on or restart the computer, and then press **esc** while the “Press the ESC key for Startup Menu” message is displayed at the bottom of the screen.
2. Press **f10** to enter Computer Setup.
3. Use a pointing device or the arrow keys to select **System Configuration > Boot Options**, and then press **enter**.
4. In the **MultiBoot Express Popup Delay (Sec)** field, enter the length of time in seconds that you want the computer to display the startup location menu before it defaults to the current MultiBoot setting. (When 0 is selected, the Express Boot startup location menu is not displayed.)
5. To save your changes and exit Computer Setup, click the **Save** icon in the lower-left corner of the screen, and then follow the on-screen instructions.
– or –
Use the arrow keys to select **File > Save Changes and Exit**, and then press **enter**.

Your changes go into effect when the computer restarts.

Entering MultiBoot Express preferences

When the Express Boot menu is displayed during startup, you have the following choices:

- To specify a boot device from the Express Boot menu, select your preference within the allotted time, and then press **enter**.
- To prevent the computer from defaulting to the current MultiBoot setting, press any key before the allotted time expires. The computer will not start until you select a boot device and press **enter**.
- To allow the computer to start according to the current MultiBoot settings, wait for the allotted time to expire.

Using HP PC Hardware Diagnostics (UEFI) (select models only)

HP PC Hardware Diagnostics is a Unified Extensible Firmware Interface (UEFI) that allows you to run diagnostic tests to determine if the computer hardware is functioning properly. The tool runs outside of the operating system to isolate hardware failures from issues that may be caused by the operating system or other software components.

To start HP PC Hardware Diagnostics UEFI:

1. Turn on or restart the computer, quickly press **esc**, and then press **f2**.

After pressing **f2**, the BIOS searches three places for the HP PC Hardware Diagnostics (UEFI) tools in the following order:

- a. Connected USB drive

 **NOTE:** To download the HP PC Hardware Diagnostics (UEFI) tool to a USB drive, see [Downloading HP PC Hardware Diagnostics \(UEFI\) to a USB device on page 120](#).

- b. Hard drive

- c. BIOS

2. Click the type of diagnostic test you want to run, and then follow the on-screen instructions.

 **NOTE:** If you need to stop a diagnostic test while it is running, press **esc**.

Downloading HP PC Hardware Diagnostics (UEFI) to a USB device

 **NOTE:** The HP PC Hardware Diagnostics (UEFI) download instructions are provided in English only.

1. Go to <http://www.hp.com>.
2. Click **Support & Drivers**, and then click the **Drivers & Software** tab.
3. Enter the product name in the text box, and then click **Search**.
4. Select your computer model, and then select your operating system.
5. In the Diagnostic section, click **HP UEFI Support Environment**.

– or –

Click **Download**, and then select **Run**.

9 Computer Setup (BIOS) and Advanced System Diagnostics in SUSE Linux

Computer Setup, or Basic Input/Output System (BIOS), controls communication between all the input and output devices on the system (such as disk drives, display, keyboard, mouse, and printer). Computer Setup includes settings for the types of peripherals installed, the startup sequence of the computer, and the amount of system and extended memory.

 **NOTE:** Use extreme care when making changes in Computer Setup. Errors can prevent the computer from operating properly.

Starting Computer Setup

 **NOTE:** An external keyboard or mouse connected to a USB port can be used with Computer Setup only if USB legacy support is enabled.

To start Computer Setup, follow these steps:

1. Turn on or restart the computer, and then press `esc` while the “Press the ESC key for Startup Menu” message is displayed at the bottom of the screen.
2. Press `f10` to enter Computer Setup.

Using Computer Setup

Navigating and selecting in Computer Setup

To navigate and select in Computer Setup, follow these steps:

1. Turn on or restart the computer, and then press `esc` while the “Press the ESC key for Startup Menu” message is displayed at the bottom of the screen.
 - To select a menu or a menu item, use the `tab` key and the keyboard arrow keys and then press `enter`, or use a pointing device to click the item.
 - To scroll up and down, click the up arrow or the down arrow in the upper-right corner of the screen, or use the up arrow key or the down arrow key.
 - To close open dialog boxes and return to the main Computer Setup screen, press `esc`, and then follow the on-screen instructions.

 **NOTE:** You can use either a pointing device (TouchPad, pointing stick, or USB mouse) or the keyboard to navigate and make selections in Computer Setup.

2. Press `f10` to enter Computer Setup.

To exit Computer Setup menus, choose one of the following methods:

- To exit Computer Setup menus without saving your changes, click the **Exit** icon in the lower-left corner of the screen, and then follow the on-screen instructions.

– or –

Use the **tab** key and the arrow keys to select **Menu > Ignore Changes and Exit**, and then press **enter**.

– or –

- To save your changes and exit Computer Setup menus, click the **Save** icon in the lower-left corner of the screen, and then follow the on-screen instructions.

– or –

Use the **tab** key and the arrow keys to select **Menu > Save Changes and Exit**, and then press **enter**.

Your changes go into effect when the computer restarts.

Restoring factory settings in Computer Setup

 **NOTE:** Restoring defaults will not change the hard drive mode.

To return all settings in Computer Setup to the values that were set at the factory, follow these steps:

1. Turn on or restart the computer, and then press **esc** while the “Press the ESC key for Startup Menu” message is displayed at the bottom of the screen.
2. Press **f10** to enter Computer Setup.
3. Use a pointing device or the arrow keys to select **Menu > Restore Defaults**.
4. Follow the on-screen instructions.
5. To save your changes and exit, click the **Save** icon in the lower-left corner of the screen, and then follow the on-screen instructions.

– or –

Use the arrow keys to select **Menu > Save Changes and Exit**, and then press **enter**.

Your changes go into effect when the computer restarts.

 **NOTE:** Your password settings and security settings are not changed when you restore the factory settings.

Updating the BIOS

Updated versions of the BIOS may be available on the HP Web site.

Most BIOS updates on the HP Web site are packaged in compressed files called *SoftPaqs*.

Some download packages contain a file named *Readme.txt*, which contains information regarding installing and troubleshooting the file.

Determining the BIOS version

To determine whether available BIOS updates contain later BIOS versions than those currently installed on the computer, you need to know the version of the system BIOS currently installed.

BIOS version information (also known as *ROM date* and *System BIOS*) can be displayed as follows:

1. Start Computer Setup.
2. Use a pointing device or the arrow keys to select **Menu > System Information**.
3. To exit Computer Setup without saving your changes, click the **Exit** icon in the lower-left corner of the screen, and then follow the on-screen instructions.

– or –

Use the **tab** key and the arrow keys to select **Menu > Ignore Changes and Exit**, and then press **enter**.

 **NOTE:** You can also determine the BIOS version by turning on or restarting the computer, pressing the **esc** key while the “Press the ESC key for Startup Menu” message is displayed at the bottom of the screen, and then pressing the **f1** key. Follow the on-screen instructions to exit this screen.

Downloading a BIOS update

 **CAUTION:** To reduce the risk of damage to the computer or an unsuccessful installation, download and install a BIOS update only when the computer is connected to reliable external power using the AC adapter. Do not download or install a BIOS update while the computer is running on battery power, docked in an optional docking device, or connected to an optional power source. During the download and installation, follow these instructions:

Do not disconnect power from the computer by unplugging the power cord from the AC outlet.

Do not shut down the computer or initiate Suspend or Hibernation.

Do not insert, remove, connect, or disconnect any device, cable, or cord.

1. Open your web browser. For U.S. support, go to <http://www.hp.com/go/contactHP>. For worldwide support, go to http://welcome.hp.com/country/us/en/wwcontact_us.html.
2. Follow the on-screen instructions to identify your computer and access the BIOS update you want to download.
3. Click the option for software and driver downloads, type your computer model number in the product box, and then press **enter**. Follow the on-screen instructions to identify your computer and access the BIOS update you want to download.
4. Click your specific product from the models listed.
5. Click the appropriate operating system.
6. Go to the BIOS section and download the BIOS software package.
7. Follow the installation instructions as provided with the downloaded BIOS software package.

 **NOTE:** After a message on the screen reports a successful installation, you can delete the downloaded file from your hard drive.

HP Sure Start

Select Intel-based 2013 HP Business Notebook PCs offer HP Sure Start, which provides hardware-based assurance of the following:

- HP-approved firmware is running on the HP Embedded Controller (EC) – EC Options in BIOS found under “BIOS Integrity Checking”
- An HP-approved BIOS is running on the host processor

HP Sure Start verifies the integrity of critical, non-executable platform data residing in the main flash and provides selfhealing mechanisms to restore any code or critical platform data that has been lost or is corrupted within the flash.

In conjunction with BIOS support, code running on the EC verifies the integrity of the following:

- Subset of BIOS contents including the boot block portion and machine-unique data
- Entire descriptor region
- Entire Network Controller Configuration

The EC is responsible for power control/power cycle, thermal monitor/fan control, many LEDs, and PS2 keyboard and mouse.

Using MultiBoot

About the boot device order

As the computer starts, the system attempts to boot from enabled devices. The MultiBoot utility, which is enabled at the factory, controls the order in which the system selects a boot device. Boot devices can include optical drives, diskette drives, a network interface card (NIC), hard drives, and USB devices. Boot devices contain bootable media or files that the computer needs to start and operate properly.



NOTE: Some boot devices must be enabled in Computer Setup before they can be included in the boot order.

You can change the order in which the computer searches for a boot device by changing the boot order in Computer Setup. You can also press **esc** while the “Press the ESC key for Startup Menu” message is displayed at the bottom of the screen, and then press **f9**. Pressing **f9** displays a menu that shows the current boot devices and allows you to select a boot device. Or, you can use MultiBoot Express to set the computer to prompt you for a boot location each time the computer turns on or restarts.

Choosing MultiBoot preferences

You can use MultiBoot in the following ways:

- To set a new boot order that the computer uses each time it is turned on, by changing the boot order in Computer Setup.
- To dynamically choose the boot device, by pressing **esc** while the “Press the ESC key for Startup Menu” message is displayed at the bottom of the screen, and then pressing **f9** to enter the Boot Device Options menu.
- To use MultiBoot Express to set variable boot orders. This feature prompts you for a boot device each time the computer is turned on or restarted.

Dynamically choosing a boot device using the f9 prompt

To dynamically choose a boot device for the current startup sequence, follow these steps:

1. Open the Select Boot Device menu by turning on or restarting the computer, and then pressing **esc** while the “Press the ESC key for Startup Menu” message is displayed at the bottom of the screen.
2. Press **f9**.
3. Use a pointing device or the arrow keys to select a boot device, then press **enter**.

Using HP PC Hardware Diagnostics (UEFI) (select models only)

HP PC Hardware Diagnostics is a Unified Extensible Firmware Interface (UEFI) that allows you to run diagnostic tests to determine if the computer hardware is functioning properly. The tool runs outside of the operating system to isolate hardware failures from issues that may be caused by the operating system or other software components.

Downloading HP PC Hardware Diagnostics (UEFI) to a USB device



NOTE: The HP PC Hardware Diagnostics (UEFI) download instructions are provided in English only.

1. Go to <http://www.hp.com>.

After pressing **f2**, the BIOS searches three places for the HP PC Hardware Diagnostics (UEFI) tools in the following order:

2. Click **Support & Drivers**, and then click the **Drivers & Software** tab.
3. Enter the product name in the text box, and then click **Search**.
4. Select your computer model, and then select your operating system.
5. In the Diagnostic section, click **HP UEFI Support Environment**.

– or –

Click **Download**, and then select **Run**.

Downloading HP PC Hardware Diagnostics (UEFI) to a USB device



NOTE: The HP PC Hardware Diagnostics (UEFI) download instructions are provided in English only.

1. Go to <http://www.hp.com>.
2. Click **Support & Drivers**, and then click the **Drivers & Software** tab.
3. Enter the product name in the text box, and then click **Search**.
4. Select your computer model, and then select your operating system.
5. In the Diagnostic section, click **HP UEFI Support Environment**.

– or –

Click **Download**, and then select **Run**.

10 Backup and recovery in Windows 8

To protect your information, use Windows backup and restore utilities to back up individual files and folders, back up your entire hard drive, create system repair media (select models only) by using the installed optical drive (select models only) or an optional external optical drive, or create system restore points. In case of system failure, you can use the backup files to restore the contents of your computer.

From the Start screen, type `restore`, click **Settings**, and then select from the list of displayed options.

 **NOTE:** For detailed instructions on various backup and restore options, perform a search for these topics in HP Support Assistant. To access HP Support Assistant on the Start screen, select the **HP Support Assistant** app.

In case of system instability, HP recommends that you print the recovery procedures and save them for later use.

 **NOTE:** Windows includes the User Account Control feature to improve the security of your computer. You may be prompted for your permission or password for tasks such as installing software, running utilities, or changing Windows settings. Refer to HP Support Assistant. To access HP Support Assistant on the Start screen, select the **HP Support Assistant** app.

Backing up your information

Recovery after a system failure is as good as your most recent backup. You should create system repair media and your initial backup immediately after initial system setup. As you add new software and data files, you should continue to back up your system on a regular basis to maintain a reasonably current backup. The system repair media (select models only) are used to start up (boot) the computer and repair the operating system in case of system instability or failure. Your initial and subsequent backups allow you to restore your data and settings if a failure occurs.

On Start screen, type `backup`, click **Settings**, and then select **Save backup copies of your files with File History**.

You can back up your information to an optional external hard drive or a network drive.

Note the following when backing up:

- Store personal files in the Documents library, and back it up regularly.
- Back up templates that are stored in their associated programs.
- Save customized settings that appear in a window, toolbar, or menu bar by taking a screen shot of your settings. The screen shot can be a time-saver if you have to reset your preferences.

To create a backup using Backup and Restore:

 **NOTE:** Be sure that the computer is connected to AC power before you start the backup process.

 **NOTE:** The backup process may take over an hour, depending on file size and the speed of the computer.

1. From the Start screen, type `backup`, click **Settings**, and then select from the list of displayed options.
2. Follow the on-screen instructions to set up your backup, create a system image (select models only), or create system repair media (select models only).

Performing a system recovery

In case of system failure or instability, the computer provides the following tools to recover your files:

- Windows recovery tools: You can use Windows Backup and Restore to recover information you have previously backed up. You can also use Windows Automatic Repair to fix problems that might prevent Windows from starting correctly.
- f11 recovery tools: You can use the f11 recovery tools to recover your original hard drive image. The image includes the Windows operating system and software programs installed at the factory.

 **NOTE:** If you are unable to boot (start up) your computer and you cannot use the system repair media you previously created (select models only), you must purchase Windows 8 operating system media to reboot the computer and repair the operating system. For additional information, see [Using Windows 8 operating system media \(purchased separately\) on page 135](#).

Using the Windows recovery tools

To recover information you previously backed up:

- ▲ Access HP Support Assistant. To access HP Support Assistant on the Start screen, select the **HP Support Assistant** app.

To recover your information using Automatic Repair, follow these steps:

 **CAUTION:** Some Automatic Repair options will completely erase and reformat the hard drive. All files you have created and any software installed on the computer are permanently removed. When reformatting is complete, the recovery process restores the operating system, as well as the drivers, software, and utilities from the backup used for recovery.

1. If possible, back up all personal files.
2. If possible, check for the presence of the HP Recovery partition and the Windows partition.

From the Start screen, type **e**, and then click **File Explorer**.

– or –

From the Start screen, type **c**, and then select **Computer**.

 **NOTE:** If the Windows partition and the HP Recovery partition are not listed, you must recover your operating system and programs using the Windows 8 operating system DVD and the *Driver Recovery* media (both purchased separately). For additional information, see [Using Windows 8 operating system media \(purchased separately\) on page 135](#).

3. If the Windows partition and the HP Recovery partition are listed, restart the computer. After Windows has loaded, press and hold the **shift** key while clicking **Restart**.
4. Select **Troubleshoot**, then select **Advanced Options**, and then select **Automatic Repair**.
5. Follow the on-screen instructions.

 **NOTE:** For additional information on recovering information using the Windows tools, perform a search for these topics in HP Support Assistant. To access HP Support Assistant on the Start screen, select the **HP Support Assistant** app.

Using f11 recovery tools

 **CAUTION:** Using **f11** completely erases hard drive contents and reformats the hard drive. All files that you have created and any software that you have installed on the computer are permanently removed. The **f11** recovery tool reinstalls the operating system and HP programs and drivers that were installed at the factory. Software not installed at the factory must be reinstalled.

To recover the original hard drive image using **f11**:

1. If possible, back up all personal files.
2. If possible, check for the presence of the HP Recovery partition: From the Start screen, type **C**, and then select **Computer**.

 **NOTE:** If the HP Recovery partition is not listed, you must recover your operating system and programs using the Windows 8 operating system media and the *Driver Recovery* media (both purchased separately). For additional information, see [Using Windows 8 operating system media \(purchased separately\) on page 135](#).

3. If the HP Recovery partition is listed, restart the computer, and then press **esc** while the “Press the ESC key for Startup Menu” message is displayed at the bottom of the screen.
4. Press **f11** while the “Press <F11> for recovery” message is displayed on the screen.
5. Follow the on-screen instructions.

Using Windows 8 operating system media (purchased separately)

To order a Windows 8 operating system DVD, contact support. See the *Worldwide Telephone Numbers* booklet included with the computer. You can also find contact information from the HP website. Go to <http://www.hp.com/support>, select your country or region, and follow the on-screen instructions.

 **CAUTION:** Using a Windows 8 operating system media completely erases hard drive contents and reformats the hard drive. All files that you have created and any software that you have installed on the computer are permanently removed. When reformatting is complete, the recovery process helps you restore the operating system, as well as drivers, software, and utilities.

To initiate recovery using a Windows 8 operating system DVD:

 **NOTE:** This process takes several minutes.

1. If possible, back up all personal files.
2. Restart the computer, and then insert the Windows 8 operating system DVD into the optical drive before the Windows operating system loads.
3. When prompted, press any keyboard key.
4. Follow the on-screen instructions.

After the repair is completed:

1. Eject the Windows 8 operating system media and then insert the *Driver Recovery* media.
2. Install the Hardware Enabling Drivers first, and then install Recommended Applications.

Using Windows Refresh for quick and easy recovery

When your computer is not working properly and you need to regain system stability, the Windows Refresh option allows you to start fresh and keep what is important to you.

 **IMPORTANT:** Refresh removes any traditional applications that were not originally installed on the system at the factory.

 **NOTE:** During Refresh, a list of removed traditional applications will be saved so that you have a quick way to see what you might need to reinstall. See HP Support Assistant for instructions on reinstalling traditional applications. To access HP Support Assistant on the Start screen, select the **HP Support Assistant** app.

 **NOTE:** You may be prompted for your permission or password when using Refresh. See HP Support Assistant for more information. To access HP Support Assistant on the Start screen, select the **HP Support Assistant** app.

To start Refresh:

1. On the Start screen, point to the far-right upper or lower corner of the screen to display the charms.
2. Click **Settings**.
3. Click **Change PC settings** in the bottom-right corner of the screen, and then select **General** from the PC settings screen.
4. Scroll the right-side choices down to display **Refresh your PC without affecting your files**.
5. Under **Refresh your PC without affecting your files**, select **Get started**, and follow the on-screen instructions.

Remove everything and reinstall Windows

Sometimes you want to perform detailed reformatting of your computer, or you want to remove personal information before you give away or recycle your computer. The process described in this section provides a speedy, simple way to return the computer to its original state. This option removes all personal data, apps, and settings from your computer, and reinstalls Windows.

 **IMPORTANT:** This option does not provide backups of your information. Before using this option, back up any personal information you wish to retain.

You can initiate this option by using the **f11** key or from the Start screen.

To use the **f11** key:

1. Press **f11** while the computer boots.
– or –
Press and hold **f11** as you press the power button.
2. Choose your language.
3. Choose your keyboard layout.
4. Select **Troubleshoot** from the boot options menu.
5. Select **Reset your PC**, and follow the on-screen instructions.

To use the Start screen:

1. On the Start screen, point to the far-right upper or lower corner of the screen to display the charms.
2. Click **Settings**.

3. Click **Change PC settings** in the bottom-right corner of the screen, and then select **General** from the PC settings screen.
4. Scroll the right-side choices down to display **Remove everything and reinstall Windows**.
5. Under **Remove everything and reinstall Windows**, select **Get started**, and follow the on-screen instructions.

Using HP Software Setup

HP Software Setup can be used to reinstall drivers or select software that has been corrupted or deleted from the system.

1. From the Start screen, type `HP Software Setup`, and select **Apps**.
2. Open HP Software Setup.
3. Follow the on-screen directions to reinstall drivers or select software.

11 Backup and recovery in Windows 7

Your computer includes HP and Windows tools to help you safeguard your information and retrieve it if you ever need to. These tools will help you return your computer to a proper working state, all with simple steps. This section provides information about the following processes:

- Creating recovery media and backups
- Restoring and recovering your system

Creating recovery media and backups

Recovery after a system failure is only as good as your most recent backup.

1. After you successfully set up the computer, create HP Recovery media. This step creates a Windows 7 operating system DVD and a *Driver Recovery* DVD. The Windows DVD can be used to reinstall the original operating system in cases where the hard drive is corrupted or has been replaced. The *Driver Recovery* DVD installs specific drivers and applications. See [Creating recovery media with HP Recovery Disc Creator on page 138](#).
2. Use Windows Backup and Recovery tools to perform the following:
 - Back up individual files and folders
 - Back up your entire hard drive (select models only)
 - Create system repair discs (select models only) with the installed optical drive (select models only) or an optional external optical drive
 - Create system restore points

 **NOTE:** This guide describes an overview of backing up, restoring, and recovering options. For more details about the tools provided, see Help and Support. To access Help and Support, select **Start > Help and Support**.

 **NOTE:** HP recommends that you print the recovery procedures and save them for later use, in case of system instability.

In case of system failure, you can use the backup files to restore the contents of your computer. See [Backing up your information on page 139](#).

Guidelines

- When creating recovery media or backing up to discs, use any of the following types of discs (purchased separately): DVD+R, DVD+R DL, DVD-R, DVD-R DL, or DVD±RW. The discs you use will depend on the type of optical drive you are using.
- Be sure that the computer is connected to AC power before you start the recovery media creation process or the backup process.

Creating recovery media with HP Recovery Disc Creator

HP Recovery Disc Creator is a software program that offers an alternative way to create recovery media. After you successfully set up the computer, you can create recovery media using HP Recovery Disc Creator. This recovery media allows you to reinstall your original operating system as well as select drivers and

applications if the hard drive becomes corrupted. HP Recovery Disc Creator can create two kinds of recovery DVDs:

- Windows 7 operating system DVD—Installs the operating system without additional drivers or applications.
- *Driver Recovery* DVD—Installs specific drivers and applications only, in the same way that the HP Software Setup utility installs drivers and applications.

Creating recovery media

 **NOTE:** The Windows 7 operating system DVD can be created only once. Thereafter, the option to create that media will not be available after you create a Windows DVD.

To create the Windows DVD:

1. Select **Start > All Programs > Productivity and Tools > HP Recovery Disc Creator**.
2. Select **Windows disk**.
3. From the drop-down menu, select the drive for burning the recovery media.
4. Click the **Create** button to start the burning process.

After the Windows 7 operating system DVD has been created, create the *Driver Recovery* DVD:

1. Select **Start > All Programs > Productivity and Tools > HP Recovery Disc Creator**.
2. Select **Driver disk**.
3. From the drop-down menu, select the drive for burning the recovery media.
4. Click the **Create** button to start the burning process.

Backing up your information

You should create system repair media and your initial backup immediately after initial system setup. As you add new software and data files, you should continue to back up your system on a regular basis to maintain a reasonably current backup. You should also create Windows system repair media (select models only) which can be used to start up (boot) the computer and repair the operating system in case of system instability or failure. Your initial and subsequent backups allow you to restore your data and settings if a failure occurs.

You can back up your information to an optional external hard drive, a network drive, or discs.

Note the following when backing up:

- Store personal files in the Documents library, and back it up regularly.
- Back up templates that are stored in their associated directories.
- Save customized settings that appear in a window, toolbar, or menu bar by taking a screen shot of your settings. The screen shot can be a time-saver if you have to reset your preferences.
- When backing up to discs, number each disc after removing it from the drive.

 **NOTE:** For detailed instructions on various backup and restore options, perform a search for these topics in Help and Support. To access Help and Support, select **Start > Help and Support**.

 **NOTE:** Windows includes the User Account Control feature to improve the security of your computer. You may be prompted for your permission or password for tasks such as installing software, running utilities, or changing Windows settings. Refer to Help and Support. To access Help and Support, select **Start > Help and Support**.

To create a backup using Windows Backup and Restore:



NOTE: The backup process may take over an hour, depending on file size and the speed of the computer.

1. Select **Start > All Programs > Maintenance > Backup and Restore**.
2. Follow the on-screen instructions to set up your backup, create a system image (select models only), or create system repair media (select models only).

Performing a system recovery

In case of system failure or instability, the computer provides the following tools to recover your files:

- Windows recovery tools: You can use Windows Backup and Restore to recover information you have previously backed up. You can also use Windows Startup Repair to fix problems that might prevent Windows from starting correctly.
- f11 recovery tools (select models only): You can use the f11 recovery tools to recover your original hard drive image. The image includes the Windows operating system and software programs installed at the factory.

f11 recovery tools (select models only): You can use the f11 recovery tools to recover your original hard drive image. The image includes the Windows operating system and software programs installed at the factory.



NOTE: If you are unable to boot (start up) your computer and you cannot use the system repair media you previously created (select models only), you must purchase Windows 7 operating system media to reboot the computer and repair the operating system. For additional information, see [Using Windows 8 operating system media \(purchased separately\) on page 135](#).

Using the Windows recovery tools

Using the Windows recovery tools, you can:

- Recover individual files
- Restore the computer to a previous system restore point
- Recover information using recovery tools



NOTE: For detailed instructions on various recovery and restore options, perform a search for these topics in Help and Support. To access Help and Support, select **Start > Help and Support**.



NOTE: Windows includes the User Account Control feature to improve the security of your computer. You may be prompted for your permission or password for tasks such as installing software, running utilities, or changing Windows settings. Refer to Help and Support. To access Help and Support, select **Start > Help and Support**.

To recover information you previously backed up:

1. Select **Start > All Programs > Maintenance > Backup and Restore**.
2. Follow the on-screen instructions to recover your system settings, your computer (select models only), or your files.

To recover your information using Startup Repair, follow these steps:

 **CAUTION:** Some Startup Repair options will completely erase and reformat the hard drive. All files you have created and any software installed on the computer are permanently removed. When reformatting is complete, the recovery process restores the operating system, as well as the drivers, software, and utilities from the backup used for recovery.

1. If possible, back up all personal files.
2. If possible, check for the presence of the Windows partition.

To check for the Windows partition, select **Start > Computer**.

 **NOTE:** If the Windows partition is not listed, you must recover your operating system and programs using the Windows 7 operating system DVD and the *Driver Recovery* media. For additional information, see [Using Windows 8 operating system media \(purchased separately\) on page 135](#).

3. If the Windows partition is listed, restart the computer, and then press **f8** before the Windows operating system loads.
4. Select **Startup Repair**.
5. Follow the on-screen instructions.

 **NOTE:** For additional information on recovering information using the Windows tools, select **Start > Help and Support**.

Using f11 recovery tools (select models only)

 **CAUTION:** Using **f11** completely erases hard drive contents and reformats the hard drive. All files that you have created and any software that you have installed on the computer are permanently removed. The **f11** recovery tool reinstalls the operating system and HP programs and drivers that were installed at the factory. Software not installed at the factory must be reinstalled.

To recover the original hard drive image using **f11**:

1. If possible, back up all personal files.
2. If possible, check for the presence of the HP Recovery partition: click **Start**, right-click **Computer**, click **Manage**, and then click **Disk Management**.

 **NOTE:** If the HP Recovery partition is not listed, you must recover your operating system and programs using the Windows 7 operating system media and the *Driver Recovery* media. For additional information, see [Using Windows 8 operating system media \(purchased separately\) on page 135](#).

3. If the HP Recovery partition is listed, restart the computer, and then press **esc** while the “Press the ESC key for Startup Menu” message is displayed at the bottom of the screen.
4. Press **f11** while the “Press <F11> for recovery” message is displayed on the screen.
5. Follow the on-screen instructions.

Using Windows 7 operating system media

If you cannot use the recovery media you previously created using the HP Recovery Disc Creator (select models only), you must purchase a Windows 7 operating system DVD to reboot the computer and repair the operating system.

To order a Windows 7 operating system DVD, go to the HP website. For U.S. support, go to <http://www.hp.com/support>. For worldwide support, go to http://welcome.hp.com/country/us/en/wwcontact_us.html. You can also order the DVD by calling support. For contact information, see the *Worldwide Telephone Numbers* booklet included with the computer.

 **CAUTION:** Using a Windows 7 operating system DVD completely erases hard drive contents and reformats the hard drive. All files that you have created and any software that you have installed on the computer are permanently removed. When reformatting is complete, the recovery process helps you restore the operating system, as well as drivers, software, and utilities.

To initiate recovery using a Windows 7 operating system DVD:

 **NOTE:** This process takes several minutes.

1. If possible, back up all personal files.
2. Restart the computer, and then insert the Windows 7 operating system DVD into the optical drive before the Windows operating system loads.
3. When prompted, press any keyboard key.
4. Follow the on-screen instructions.
5. Click **Next**.
6. Select **Repair your computer**.
7. Follow the on-screen instructions.

After the repair is completed:

1. Eject the Windows 7 operating system DVD and then insert the *Driver Recovery* DVD.
2. Install the Hardware Enabling Drivers first, and then install Recommended Applications.

12 Backup and Recovery in SUSE Linux

Recovery after a system failure is as good as your most recent backup. As you add new software and data files, you should continue to back up your system on a regular basis to maintain a reasonably current backup.

Your computer includes tools provided by HP to help you safeguard your information and retrieve it if ever needed.

Creating backups

1. Create restore media immediately after you set up the computer. For more information, see [Performing a system recovery on page 145](#).
2. As you add files, routinely create a backup of your system and personal information.

Backing up your information

You should back up your computer files on a regular schedule to maintain a current backup. You can manually back up your information to an optional external drive, a network drive, or discs. Back up your system at the following times:

- At regularly scheduled times
- Before the computer is repaired or restored
- Before you add or modify hardware or software

To back up your home directory files using **Backup Manager Settings**:

1. Select **Computer > More Applications > Tools > Backup Manager Settings**, and click **Backup my home directory**.
2. Click **Storage Destination Location**, and then select a location to back up your information.
3. Click **Schedule**, and then select a time schedule to perform backups at a regularly scheduled time.

To immediately back up your information, click the **Backup Now** check box.



NOTE: Before you back up your information, be sure you have designated a location to save the backup files.

4. Click **Save and Backup** to start the backup and to save the backup settings.

To restore backup files:

1. Select **Computer > More Applications > Tools > Backup Manager Restore**.
2. Click **Backup Source**, and then select the location of the backup files.
3. Click **Restore Destination**, and then select the destination to restore the files.
4. To restore all files from the selected location, click **Restore all files**. To restore select files only, click **Restore selected files**, click **Select Files** and then select the files to be restored.
5. Under **Restore Point**, click the time and date of the backup.

 **NOTE:** If multiple backups have been performed, click **Use the latest version** to restore the latest version.

6. Click **Restore** to start restoring the files, or click **Cancel** to cancel the operation.

Performing a system recovery

Recovery allows you to repair or restore the computer to its original factory state. You can create an HP Factory Image, using an installed or an external DVD±RW optical drive.

 **NOTE:** Your computer may not come equipped with an internal optical drive. In order to create the HP Factory Image, you may need to plug in an external optical drive.

 **CAUTION:** Using Recovery completely erases hard drive contents and reformats the hard drive. All files you have created and any software installed on the computer are permanently removed. The recovery tool reinstalls the original operating system and HP programs and drivers that were installed at the factory. Software, drivers, and updates not installed by HP must be manually reinstalled. Personal files must be restored from a backup.

To restore the computer using the HP Factory Image, you must first create the recovery ISO file and then burn it to an optical disc.

 **NOTE:** HP recommends that you create the HP Factory Image in the event of a system failure.

1. Select **Computer > More Applications**.
2. In the left pane, click **Tools**, and then click **Create HP Factory Image** in the right pane.
3. Enter the root password when prompted.
4. Right-click on the HP_Recovery.iso file and select **Open with Brasero**.
5. Insert a blank DVD disc and select **Burn**. This creates the HP Factory Image Restore DVD.

To restore the computer from the recovery disc, follow these steps:

1. If possible, back up all personal files.
2. Insert the HP Factory Image Restore DVD into the optical drive and restart the computer.
3. As the computer is restarting, press **f9** to open the Computer Setup boot option menu.
4. Select **Optical Disk Drive** from the Boot Options menu and press **enter**.
5. Press **enter** to select **Restore System from Media**.
6. At both of the System Recovery prompts, select **Yes**.

Remove everything and reinstall SLED

Sometimes you want to perform detailed reformatting of your computer, or you want to remove personal information before you give away or recycle your computer. The process described in this section provides a speedy, simple way to return the computer to its original state. This option removes all personal data, applications, and settings from your computer, and reinstalls the Linux operating system.

 **IMPORTANT:** This option does not provide backups of your information. Before using this option, back up any personal information you wish to retain.

You can initiate this option by using the **f11** key.

To use the **f11** key:

Press **f11** while the computer boots.

– or –

Press and hold **f11** as you press the power button.

Select **System Recovery** and follow the on-screen instructions.

13 Specifications

Computer specifications—HP EliteBook 840/HP ZBook 14 models

	Metric	U.S.
Dimensions		
Width	33.9 cm	13.35 in
Depth	23.7 cm	9.33 in
Height	2.1 cm	0.83 in
Height (touch models)	2.3 cm	0.89 in
Weight		
Non-touch panel: Equipped with 3-cell (24 Whr) battery, UMA graphics, one memory module, WLAN module, and solid-state drive	1.62 kg	3.57 lbs
Touch panel: Equipped with 3-cell (24 Whr) battery, UMA graphics, one memory module, WLAN module, and solid-state drive	1.78 kg	3.92 lbs
Non-touch panel: Equipped with 3-cell (50 Whr) battery, UIMA graphics, one memory module, WLAN module, and solid-state drive	1.74 kg	3.83 lbs
Touch panel: Equipped with 3-cell (50 Whr) battery, UIMA graphics, one memory module, WLAN module, and solid-state drive	1.87 kg	4.12 lbs
Input power		
Operating voltage and current	18.5 V dc @ 3.5 A - 65 W – or – 19.0 V dc @ 4.74 A - 90 W	
Temperature		
Operating	5°C to 35°C	41°F to 95°F
Nonoperating	-20°C to 60°C	-4°F to 140°F
Relative humidity (noncondensing)		
Operating	10% to 90%	
Nonoperating	5% to 95%	
Maximum altitude (unpressurized)		
Operating	-15 m to 3,048 m	-50 ft to 10,000 ft
Nonoperating	-15 m to 12,192 m	-50 ft to 40,000 ft
NOTE: Applicable product safety standards specify thermal limits for plastic surfaces. The device operates well within this range of temperatures.		

Computer specifications—HP EliteBook 850 models

	Metric	U.S.
Dimensions		
Width	37.6 cm	14.78 in
Depth	25.4 cm	9.98 in
Height	2.2 cm	0.85 in
Weight		
Equipped with 3-cell (24 Whr) battery, UIMA graphics, one memory module, WLAN module, and solid-state drive	1.97 kg	4.35 lbs
Equipped with 3-cell (50 Whr) battery, UIMA graphics, one memory module, WLAN module, and solid-state drive	2.09 kg	4.61 lbs
Input power		
Operating voltage and current	18.5 V dc @ 3.5 A - 65 W – or – 19.0 V dc @ 4.74 A - 90 W	
Temperature		
Operating	5°C to 35°C	41°F to 95°F
Nonoperating	-20°C to 60°C	-4°F to 140°F
Relative humidity (noncondensing)		
Operating	10% to 90%	
Nonoperating	5% to 95%	
Maximum altitude (unpressurized)		
Operating	-15 m to 3,048 m	-50 ft to 10,000 ft
Nonoperating	-15 m to 12,192 m	-50 ft to 40,000 ft
NOTE: Applicable product safety standards specify thermal limits for plastic surfaces. The device operates well within this range of temperatures.		

35.6-cm (14.0-in) HD SVA display specifications

	Metric	U.S.
Dimensions		
Height	22.43 cm	8.83 in
Width	36.0 cm	14.17 in
Depth	0.38 cm	0.15 in
Diagonal	35.6 cm	15.6 in
Weight	< 1.1 lb (500 g) (max)	

	Metric	U.S.
Contrast ratio	300:1 (typical)	
Brightness	200 nits (typical)	
Refresh Rate	60 Hz	
Surface Treatment	Anti-glare	
Pixel resolution		
Format	HD (1366 x 768)	
Configuration	RGB stripe	
LCD Mode	TN	
PPI	101 PPI	
Interface	eDP 1.2 (1 lane)	
Viewing angle	SVA 40/40/15/30 (Left/Right/Down/Up)	

35.6-cm (14.0-in) HD+ SVA display specifications

	Metric	U.S.
Dimensions		
Height	20.6 cm	8.09 in
Width	32.1 cm	12.6 in
Depth	0.36 cm	0.14 in
Diagonal	35.6 cm	14.0 in
Weight	0.72 lb (325 g) (max)	
Contrast ratio	300:1 (typical)	
Brightness	250 nits (typical)	
Refresh Rate	60 Hz	
Surface Treatment	Anti-glare	
Pixel resolution		
Format	HD+ (1600 x 900)	
Configuration	RGB stripe	
LCD Mode	TN	
PPI	131 PPI	
Interface	eDP 1.2 (1 lane)	
Viewing angle	SVA 40/40/15/30 (Left/Right/Down/Up)	

35.6-cm (14.0-in) HD+ SVA display specifications

	Metric	U.S.
Dimensions		
Height	20.6 cm	8.09 in
Width	32.1 cm	12.6 in
Depth	0.36 cm	0.14 in
Diagonal	35.6 cm	14.0 in
Weight	0.75 lb (340 g) (max)	
Contrast ratio	300:1 (typical)	
Brightness	300 nits (typical)	
Refresh Rate	60 Hz	
Surface Treatment	Anti-glare	
Pixel resolution		
Format	FHD (1920 x 1080)	
Configuration	RGB stripe	
LCD Mode	IPS/FFS/VA	
PPI	157 PPI	
Interface	eDP 1.2 (1 lane)	
Viewing angle	UWVA 85/85/85/85 (Left/Right/Down/Up)	

39.6-cm (15.6-in) HD SVA display specifications

	Metric	U.S.
Dimensions		
Height	20.6 cm	8.09 in
Width	32.1 cm	12.6 in
Depth	0.36 cm	0.14 in
Diagonal	39.6 cm	14.0 in
Weight	< 1.1 lb (500 g) (max)	
Contrast ratio	300:1 (typical)	
Brightness	200 nits (typical)	
Refresh Rate	60 Hz	
Surface Treatment	Anti-glare	
Pixel resolution		
Format	HD (1366 x 768)	

	Metric	U.S.
Configuration	RGB stripe	
LCD Mode	TN	
PPI	125 PPI	
Interface	eDP 1.2 (1 lane)	
Viewing angle	SVA 40/40/15/30 (Left/Right/Down/Up)	

39.6-cm (15.6-in) FHD SVA display specifications

	Metric	U.S.
Dimensions		
Height	20.6 cm	8.09 in
Width	32.1 cm	12.6 in
Depth	0.36 cm	0.14 in
Diagonal	39.6 cm	14.0 in
Weight	< 0.84 lb (380 g) (max)	
Contrast ratio	400:1 (typical)	
Brightness	300 nits (typical)	
Refresh Rate	60 Hz	
Surface Treatment	Anti-glare	
Pixel resolution		
Format	HD (1920 x 1080)	
Configuration	RGB stripe	
LCD Mode	TN	
PPI	142 PPI	
Interface	eDP 1.2 (1 lane)	
Viewing angle	SVA 45/45/25/35 (Left/Right/Down/Up)	

Hard drive specifications

	1-TB*	500-GB*	320-GB*
Dimensions			
Height	9.5 mm	9.5 mm	9.5 mm
Width	70 mm	70 mm	70 mm
Weight	115 g	101 g	115 g

	1-TB*	500-GB*	320-GB*
Interface type	SATA	SATA	SATA
Transfer rate			
Synchronous (maximum)	Synchronous (maximum) 300 MB/s (Drive Capability)		
Security	ATA security		
Seek times (typical read, including setting)			
Single track	3 ms	1.5ms/3 ms	1.5 ms
Average (read/write)	13 ms	11 ms/13 ms	11 ms
Maximum	24 ms	22 ms/24 ms	22 ms
Logical blocks	1,953,525,168	976,773,168	625,142,448
Disk rotational speed	5400 rpm	5400 rpm or 7200 rpm	5400 rpm or 7200 rpm
Operating temperature	0°C to 60°C (32°F to 140°F)		
*1 GB = 1 billion bytes when referring to hard drive storage capacity. Actual accessible capacity is less.			
NOTE: Certain restrictions and exclusions apply. Contact technical support for details.			

Solid-state drive specifications

	128-GB*	180-GB*	240-GB*	256-GB*
Dimensions				
Height	7 mm	7 mm	7 mm	7 mm
Width	70 mm	70 mm	70 mm	70 mm
Weight	73 g	78 g	78 g	73 g
Interface	SATA 3 (6 Gb/s)	SATA 3 (6 Gb/s)	SATA 3 (6 Gb/s)	SATA 3 (6 Gb/s)
Transfer rate				
Maximum Sequential Read	415 MB/s	Up to 550 MB/s	550 MB/s	Up to 460 MB/s
Maximum Sequential Write	175 MB/s	Up to 520 MB/s	520 MB/s	Up to 260 MB/s
Total logical sectors	250,069,680	351,651,888	468,862,128	500,118,192
Features	ATA Security; ATA-8; SATA 3.0; DIPM; TRIM	ATA Security; ATA-8; SATA 3.0; DIPM; TRIM	ATA Security; ATA-8; SATA 3.0; DIPM; TRIM	ATA Security; ATA-8 compliant; SATA 3.0; DIPM; TRIM
Operating temperature	0° to 70°C (32°F to 158°F)			
*1 GB = 1 billion bytes when referring to hard drive storage capacity. Actual accessible capacity is less.				
NOTE: Certain restrictions and exclusions apply. Contact technical support for details.				

14 Statement of Volatility

The purpose of this document is to provide general information regarding non-volatile memory in industry-standards based HP Business Notebook PC systems and provide general instructions for restoring nonvolatile memory that can contain personal data after the system has been powered off and the hard drive has been removed.

HP Business Notebook PC products that use Intel®-based or AMD®-based system boards contain volatile DDR memory. The amount of nonvolatile memory present in the system depends upon the system configuration. Intel-based and AMD-based system boards contain nonvolatile memory subcomponents as originally shipped from HP assuming that no subsequent modifications have been made to the system and assuming that no applications, features, or functionality have been added to or installed on the system.

Following system shutdown and removal of all power sources from an HP Business Notebook PC system, personal data can remain on volatile system memory (DIMMs) for a finite period of time and will also remain in nonvolatile memory. The steps below will remove personal data from the notebook PC, including the nonvolatile memory found in Intel-based and AMD-based system boards. Some of these steps are disclosed in the Maintenance & Service Guides available for HP PC products available on the product support pages at www.hp.com.

1. Follow steps (a) through (i) below to restore the nonvolatile memory that can contain personal data. Restoring or re-programming nonvolatile memory that does not store personal data is neither necessary nor recommended.
 - a. Enter BIOS (F10) Setup by powering on the system and pressing **F10** when prompted near the bottom of the display, or press the **ESC** key to display the start up menu, then press **F10**. If the system has a BIOS administrator password, enter the password at the prompt.
 - b. Select the **File** menu, then **Restore Defaults**.
 - c. Select the **System Configuration** menu, then **Restore Security Defaults**.
 - d. If an asset or ownership tag is set, select the **Security** menu and scroll down to the **Utilities** menu. Select **System IDs**, and then select the tag that has been set. Press the spacebar once to clear the tag, then press **Enter** to return to the prior menu.
 - e. If a DriveLock password is set, select the **Security** menu, select **Hard Drive Tools**, scroll down to **DriveLock**, then select **DriveLock password**. Select the desired hard drive. Click **Disable protection**, enter the existing master DriveLock password, then press **Enter** to confirm and return to the prior menu. Repeat this procedure if more than one hard drive has a DriveLock password.
 - f. If an Automatic DriveLock password is set, select the **Security** menu, select **Hard Drive Tools**, scroll down to **Automatic DriveLock**, then select the desired hard drive and disable protection. Repeat this procedure if more than one hard drive has an Automatic DriveLock password.
 - g. Select the **File** menu, then **Reset BIOS Security** to factory default. Click **yes** at the warning message.
 - h. Select the **File** menu, then **Save Changes and Exit**.
 - i. Reboot the system. If the system has a Trusted Platform Module (TPM) and/or fingerprint sensor, one or two prompts will appear. One to clear the TPM and the other to Reset Fingerprint Sensor; press **F1** to accept or **F2** to reject.

If the HP notebook model number includes Intel® Centrino with VPro™, reboot the PC and enter BIOS Setup by pressing **F10** when prompted. Select **System Configuration**, then **AMT Options**.

Then select **Un-configure AMT on next boot**. Select **Save** then **Yes**. Select the **File** menu, and then select **Save Changes and Exit**. Reboot the system and confirm that you want to un-configure AMT.

- j. If the optional Intel® Anti-Theft Technology (AT) was activated, contact the provider to de-activate it.
 - k. If the optional Absolute® Software Computrace® management and tracking service was activated on the notebook PC, contact the provider to deactivate it.
 - l. Remove all power and system batteries for at least 24 hours.
2. Remove and retain the storage drive or clear the contents of the drive.

a. Hard Disk Drive (HDD)

Clear the HDD contents by using the HP Disk Sanitizer® utility or a third party application that, ideally, is U.S. Department of Defense (DOD) 5220.22-M approved.

To run HP Disk Sanitizer, enter BIOS Setup by powering on the system and pressing **F10** when prompted near the bottom of the display, or press **ESC** to display the start up menu, then press **F10**. Select the **Security** menu and scroll down to the **Utilities** menu. Select **Disk Sanitizer** and select the desired drive. For a higher level of protection, select **Optimum**.



NOTE: This process will take a long time, and the amount of time varies based on the hard drive capacity.

b. Solid State Drive (SSD)

Clear the SSD contents by using the BIOS Setup Secure Erase command option, or by using a third party utility designed to erase data from an SSD. To run Secure Erase, enter BIOS Setup by powering on the system and pressing **F10** when prompted near the bottom of the display. Select the **Security** menu and scroll down to the **Utilities** menu. Select **Secure Erase** and select the desired hard drive.

HP Sure Start

Select Intel-based 2013 HP Business Notebook PCs offer HP Sure Start, which provides hardware-based assurance of the following:

- HP-approved firmware is running on the HP Embedded Controller (EC) – EC Options in BIOS found under “BIOS Integrity Checking”
- An HP-approved BIOS is running on the host processor

HP Sure Start verifies the integrity of critical, non-executable platform data residing in the main flash and provides selfhealing mechanisms to restore any code or critical platform data that has been lost or is corrupted within the flash.

In conjunction with BIOS support, code running on the EC verifies the integrity of the following:

- Subset of BIOS contents including the boot block portion and machine-unique data
- Entire descriptor region
- Entire Network Controller Configuration

The EC is responsible for power control/power cycle, thermal monitor/fan control, many LEDs, and PS2 keyboard and mouse.

Non-volatile memory usage

Non Volatile Memory Type	Amount (Size)	Does this memory store customer data?	Does this memory retain data when power is removed?	What is the purpose of this memory?	How is data input into this memory?	How is this memory write protected?
Real Time Clock (RTC) battery backed-up CMOS configuration memory (CMOS)	256 Bytes	No	Yes	Stores system date and time and limited keyboard controller data.	Using the F10 Setup utility or changing the Microsoft® Windows® date & time.	This memory is not write-protected. HP recommends password protecting the F10 Setup utility.
Controller (NIC) EEPROM	64 Kbytes (not customer accessible)	No	Yes	Store NIC configuration and NIC firmware.	Using a utility from the NIC vendor that can be run from DOS.	A utility is required to write data to this memory and is available from NIC vendor. Writing data to this ROM in an inappropriate manner will render the NIC non-functional.
Keyboard ROM	64 Kbytes (not customer accessible)	No	Yes	Stores firmware code (keyboard, mouse, & battery management).	Programmed at the factory. Code is updated when the system BIOS is updated.	A utility is required for writing data to this memory and is available on the HP website. Writing data to this ROM in an inappropriate manner can render the PC non-functional.
DIMM Serial Presence Detect (SPD) configuration data	256 Bytes per memory module, 128 Bytes programmable (not customer accessible)	No	Yes	Stores memory module information.	Programmed by the memory vendor.	Data cannot be written to this memory when the module is installed in a PC. The specific write protection method varies by memory vendor.
System BIOS	4 to 5 MBytes	Yes	Yes	Store system BIOS code and PC configuration data.	System BIOS code is programmed at the factory. Code is updated when the system BIOS is updated. Configuration data and settings are input using the F10 setup utility or a custom utility.	A utility is required for writing data to this memory and is available on the HP website. Writing data to this ROM in an inappropriate manner can render the PC non-functional.
Intel Management Engine Firmware (present only in models ending in a 'p' or 'w' or with Intel Centrino Pro technology)	1.5 or 5MByte	Yes	Yes	Stores Management Engine Code, Settings, Provisioning Data and iAMT third party data store.	Management Engine Code is programmed at the factory. Code is updated via Intel secure firmware update utility. Unique Provisioning Data can be entered at the factory or by an administrator using the Management Engine (MEBx) setup utility. The third party data store contents can be populated by a remote management console or local applications registered by an	The Intel chipset is configured to enforce HW protection to block all direct read/write access to this area. An Intel utility is required for updating the firmware. Only firmware updates digitally signed by Intel can be applied using this utility.

Non Volatile Memory Type	Amount (Size)	Does this memory store customer data?	Does this memory retain data when power is removed?	What is the purpose of this memory?	How is data input into this memory?	How is this memory write protected?
					administrator to have access to the space.	
Bluetooth flash	2Mbit	No	Yes	Stores Bluetooth configuration and firmware.	Programmed at the factory. Tools for writing data to this memory are not publicly available but can be obtained from the silicon vendor.	A utility is required for writing data to this memory and is made available through newer versions of the driver if the flash requires an upgrade.
802.11 WLAN EEPROM	4kb to 8kb	No	Yes	Stores configuration and calibration data.	Programmed at the factory. Tools for writing data to this memory are not made public.	A utility is required for writing data to this memory and is typically not made available to the public unless a firmware upgrade is necessary to address a unique issue.
Web Camera	64K bit	No	Yes	Store Web Cam configuration and firmware.	Using a utility from the device manufacturer that can be run from Windows.	A utility is required for writing data to this memory and is typically not made available to the public unless a firmware upgrade is necessary to address a unique issue.
Fingerprint Reader	512kByte Flash	Yes	Yes	Stores fingerprint templates.	By enrolling in HP ProtectTools Security Manager.	Only a digitally signed application can make the call to write to the flash.

Questions and answers

1. **How can the BIOS settings be restored (returned to factory settings)?**
 - a. Turn on or restart the computer and press **F10** when prompted near the bottom of the display.
 - b. Select **File**, then select **Restore defaults**.
 - c. Follow the on-screen instructions.
 - d. Select **File**, save changes and exit, then press **Enter**.

2. **What kind of configuration data is stored on the DIMM Serial Presence Detect (SPD) memory module? How would this data be written?**

The DIMM SPD memory contains information about the memory module such as size, serial number, data width, speed/timing, voltage and thermal information. This information is written by the module manufacturer and stored on an EEPROM. This EEPROM cannot be written to when the memory module is installed in a PC. Third party tools do exist that can write to the EEPROM when the memory module is not installed in a PC. There are various third party tools available to read SPD memory.

3. **Does the “Firmware Hub for System BIOS” contain the BIOS program? Is this chip writable, and if so how?**

The Firmware Hub does contain the BIOS program and is writable. A utility is required to perform the write function.

- 4. In some PC systems, the Firmware Hub for System BIOS is a flash memory chip so that updates can be written by the customer. Is this true for these BIOS chips?**

Yes, they are flash memory chips.

- 5. What is meant by “Restore the nonvolatile memory found in Intel-based system boards”?**

This relates to clearing the Real Time Clock (RTC) CMOS memory that contains PC configuration data.

- 6. Does resetting the CMOS configuration memory return the PC back to factory defaults?**

The process of resetting the CMOS will return certain system settings to factory default but will not reset many of the system data and configuration defaults to their factory settings. To return these system data and configuration defaults to factory settings, refer to question and answer 1 and follow the instructions for returning the BIOS settings to factory defaults.

15 Power cord set requirements

The wide-range input feature of the computer permits it to operate from any line voltage from 100 to 120 volts AC, or from 220 to 240 volts AC.

The 3-conductor power cord set included with the computer meets the requirements for use in the country or region where the equipment is purchased.

Power cord sets for use in other countries and regions must meet the requirements of the country or region where the computer is used.

Requirements for all countries

The following requirements are applicable to all countries and regions:

- The length of the power cord set must be at least **1.0 m** (3.3 ft) and no more than **2.0 m** (6.5 ft).
- All power cord sets must be approved by an acceptable accredited agency responsible for evaluation in the country or region where the power cord set will be used.
- The power cord sets must have a minimum current capacity of 10 amps and a nominal voltage rating of 125 or 250 V AC, as required by the power system of each country or region.
- The appliance coupler must meet the mechanical configuration of an EN 60 320/IEC 320 Standard Sheet C13 connector for mating with the appliance inlet on the back of the computer.

Requirements for specific countries and regions

Country/region	Accredited agency	Applicable note number
Australia	EANSW	1
Austria	OVE	1
Belgium	CEBC	1
Canada	CSA	2
Denmark	DEMKO	1
Finland	FIMKO	1
France	UTE	1
Germany	VDE	1
Italy	IMQ	1
Japan	METI	3
The Netherlands	KEMA	1
Norway	NEMKO	1
The People's Republic of China	COC	5
South Korea	EK	4

Country/region	Accredited agency	Applicable note number
Sweden	SEMKO	1
Switzerland	SEV	1
Taiwan	BSMI	4
The United Kingdom	BSI	1
The United States	UL	2

1. The flexible cord must be Type H05VV-F, 3-conductor, 1.0-mm² conductor size. Power cord set fittings (appliance coupler and wall plug) must bear the certification mark of the agency responsible for evaluation in the country or region where it will be used.
2. The flexible cord must be Type SPT-3 or equivalent, No. 18 AWG, 3-conductor. The wall plug must be a two-pole grounding type with a NEMA 5-15P (15 A, 125 V) or NEMA 6-15P (15 A, 250 V) configuration.
3. The appliance coupler, flexible cord, and wall plug must bear a “T” mark and registration number in accordance with the Japanese Dentori Law. The flexible cord must be Type VCT or VCTF, 3-conductor, 1.00-mm² conductor size. The wall plug must be a two-pole grounding type with a Japanese Industrial Standard C8303 (7 A, 125 V) configuration.
4. The flexible cord must be Type RVV, 3-conductor, 0.75-mm² conductor size. Power cord set fittings (appliance coupler and wall plug) must bear the certification mark of the agency responsible for evaluation in the country or region where it will be used.
5. The flexible cord must be Type VCTF, 3-conductor, 0.75-mm² conductor size. Power cord set fittings (appliance coupler and wall plug) must bear the certification mark of the agency responsible for evaluation in the country or region where it will be used.

16 Recycling

When a non-rechargeable or rechargeable battery has reached the end of its useful life, do not dispose of the battery in general household waste. Follow the local laws and regulations in your area for battery disposal.

HP encourages customers to recycle used electronic hardware, HP original print cartridges, and rechargeable batteries. For more information about recycling programs, see the HP Web site at <http://www.hp.com/recycle>.

Index

A

- AC adapter, spare part numbers 36, 39, 44
- AC adapter/battery light 13
- accessory battery connector, identifying 17
- antenna
 - removal 113
 - spare part numbers 31, 33, 41, 43, 114
- audio, product description 4
- audio-in (microphone) jack, identifying 16
- audio-out (headphone) jack, identifying 16

B

- backup 144
- Backup and Restore 133, 140
- backup tools 138
- backups
 - creating 139
 - recovering 140
- base enclosure
 - spare part numbers 29, 41, 44, 79, 82
- base enclosure, 14-inch models
 - removal 79
- base enclosure, 15-inch models
 - removal 82
- battery
 - removal 59
 - spare part numbers 21, 39, 59
- BIOS
 - determining version 116, 122, 129
 - downloading an update 117, 123, 130
 - updating 116, 122, 129
- Blu-ray ROM DVD±RW SuperMulti DL Drive
 - precautions 54
- buttons
 - left pointing stick 9
 - left TouchPad 9

- power 11
- right pointing stick 9
- right TouchPad 9
- Windows button 12

C

- cables, service considerations 53
- caps lock light, identifying 10
- card reader board
 - removal 86
 - spare part number 21, 41, 86
- chipset, product description 1
- components
 - bottom 17
 - display 8
 - front 13
 - left side 15
 - right side 16
 - top 9
- computer major components 20
- computer part number 19
- computer reset 136, 145
- Computer Setup
 - navigating and selecting 115, 121, 127
 - restoring factory settings 116, 122, 129
- computer setup
 - navigating and selecting 127
 - restoring factory settings 129
- computer specifications 147, 148
- connector, power 16
- connectors, service considerations 53

D

- display
 - specifications 148, 149, 150, 151
- display assembly
 - removal 108
 - subcomponents 31
- display bezel
 - spare part numbers 31, 33, 41

- display enclosure, spare part numbers 32, 33, 41
- display hinge
 - removal 113
 - spare part numbers 32, 33, 41, 43
- Display Hinge Kit, spare part numbers 32, 33, 41, 43
- display panel
 - product description 2
 - removal 75
 - spare part numbers 32, 33
- display panel cable
 - spare part numbers 31, 33, 41
- DisplayPort, identifying 16
- docking connector, identifying 16
- Driver Recovery DVD,
 - creating 138
 - using for restore 142
- drives, preventing damage 54
- DVD-ROM Drive
 - precautions 54
- DVD±RW Double-Layer with SuperMulti Drive
 - precautions 54

E

- electrostatic discharge 54
- embedded numeric keypad, identifying 12
- equipment guidelines 56
- esc key, identifying 12
- Ethernet, product description 4
- external VGA monitor port 15

F

- f11 recovery 135, 142
- fan
 - removal 85
 - spare part number 22, 39, 85
- fingerprint reader assembly
 - removal 94
 - spare part number 41, 94
- fingerprint reader board
 - spare part number 21

- fingerprint reader insert, illustrated 35
- fingerprint reader, identifying 12
- flash cache
 - product description 3
- fn key, identifying 12
- function keys, identifying 12

G

- graphics, product description 1
- grounding guidelines 54
- guidelines
 - equipment 56
 - grounding 54
 - packaging 55
 - transporting 55
 - workstation 55

H

- hard drive
 - precautions 54
 - product description 3
 - removal 60
 - spare part numbers 22, 34, 39, 44, 45, 60
 - specifications 151
- hard drive bracket
 - removal 61
- Hard Drive Hardware Kit
 - contents 33
 - spare part number 22, 33, 39, 60
- hard drive light 14
- hard drive recovery 135, 142
- hard drive, identifying 17, 18
- headphone (audio-out) jack 16
- heat sink
 - removal 88
 - spare part numbers 22, 41, 42, 43, 88
- HP Recovery Disc Creator, using 138
- HP Recovery partition
 - checking for presence 142
 - using for recovery 142

I

- integrated webcam light, identifying 8
- internal display switch 8
- internal microphones, identifying 8

J

- jacks
 - audio-in (microphone) 16
 - audio-out (headphone) 16
 - network 16
 - RJ-45 (network) 16

K

- keyboard
 - product description 5
 - removal 71
 - spare part numbers 21, 39, 40, 42, 43, 71
- keypad
 - embedded numeric 12
- keys
 - esc 12
 - fn 12
 - function 12

L

- latches, service cover release 17, 18
- legacy support, USB 115, 121, 127
- lights
 - AC adapter/battery 13
 - caps lock 10
 - hard drive 14
 - power 10, 13
 - webcam 8
 - wireless 10, 13

M

- mass storage device
 - illustrated 33
 - precautions 54
 - spare part numbers 33
- memory card reader, identifying 16
- memory module
 - identifying 17, 18
 - product description 2
 - removal 65
 - spare part numbers 22, 39, 65
- microphone
 - product description 4
- microphone (audio-in) jack, identifying 16
- microphone module
 - spare part numbers 31, 33, 40, 76

- mini-card SSD
 - product description 4
- model description 19
- model name 1
- mouse, spare part numbers 37

N

- network jack, identifying 16

O

- operating system, product description 5
- optical drive
 - precautions 54

P

- packaging guidelines 55
- plastic parts, service considerations 53
- Plastics Kit
 - contents 35
 - spare part numbers 35, 41
- pointing device, product description 5
- pointing stick 9
- ports
 - DisplayPort 16
 - external VGA monitor 15
 - product description 4
- power button board
 - removal 92
 - spare part number 21, 41, 92
- power button, identifying 11
- power connector, identifying 16
- power cord
 - set requirements 158
 - spare part numbers 36, 38, 44
- power lights 10, 13
- power requirements, product description 5
- processor
 - product description 1
- product description
 - audio 4
 - chipset 1
 - display panel 2
 - Ethernet 4
 - external media cards 4
 - flash cache 3
 - graphics 1
 - hard drive 3

- keyboard 5
- memory module 2
- microphone 4
- mini-card SSD 4
- operating system 5
- pointing device 5
- ports 4
- power requirements 5
- processors 1
- product name 1
- security 5
- serviceability 7
- solid-state drive 3
- video 4
- wireless 4
- product name 1, 19
- product number 19

R

- recovery 136, 144
- recovery media, creating 138
- recovery media, using for restore 142
- recovery partition 135, 142
- recovery tools 138
- recovery tools, Windows 140
- recovery, system 140
- recycle
 - computer 136
- refresh 136
- removal/replacement
 - preliminaries 53
 - procedures 57, 75
- remove everything and reinstall
 - Windows 136
- reset
 - computer 136, 145
 - steps 136, 145
- restoring the hard drive 135, 142
- RJ-45 (network) jack, identifying 16
- RJ-45 door, illustrated 35
- RJ-45 flat spring, illustrated 35
- RTC battery
 - removal 64
 - spare part number 21, 38, 64
- Rubber Kit, spare part numbers 30, 41

S

- Screw Kit, spare part numbers 37, 41
- SD card insert 35
- security cable slot, identifying 15
- security, product description 5
- serial number 19
- service considerations
 - cables 53
 - connectors 53
 - plastic parts 53
- service cover
 - removal 57
 - spare part numbers 30, 57
- service cover release latch 17, 18
- service tag 19
- serviceability, product description 7
- setup utility
 - navigating and selecting 115, 121
 - restoring factory settings 116, 122
- SIM slot, identifying 17, 19
- SLED
 - remove everything and reinstall option 145
- slots
 - security cable 15
 - smart card 15
- smart card slot 15
- solid-state drive
 - precautions 54
 - product description 3
 - removal 62
 - spare part numbers 30, 34, 44, 62
 - specifications 152
- speaker assembly
 - removal 106
 - spare part number 21, 41, 106
- speakers, identifying 12
- specifications
 - computer 147, 148
 - display 148, 149, 150, 151
 - hard drive 151
 - solid-state drive 152
- Startup Repair, using 140

- system board
 - removal 96
 - spare part numbers 22, 45, 46, 47, 48, 49, 50, 51, 52, 96
- system board, gold conversion kits
 - spare part numbers 26, 99

T

- tools required 53
- top cover, spare part numbers 21, 41, 42
- TouchPad
 - buttons 9
- TouchPad zone
 - identifying 9
- transporting guidelines 55

U

- USB 3.0 port 15, 16
- USB legacy support 115, 121, 127
- USB ports, identifying 15, 16

V

- vents, identifying 15, 17, 18
- VGA/USB board
 - removal 87
 - spare part number 21, 41, 42, 87
- video, product description 4

W

- warranty period 19
- webcam 8
- webcam light, identifying 8
- webcam module
 - removal 78
 - spare part numbers 31, 33, 39
- webcam, identifying 8
- webcam/microphone module
 - removal 112
- Windows
 - Refresh 136
 - reinstall 136
 - remove everything and reinstall option 136
 - reset 136
- Windows 7 operating system DVD
 - creating 138
 - using for restore 142

- Windows 7 operating system media
 - creating 138
 - using for restore 142
- Windows 8 operating system DVD 135
- Windows button, identifying 12
- Windows Startup Repair, using 140
- wireless antenna
 - removal 113
 - spare part numbers 31, 33, 114
- Wireless Antenna Kit, spare part numbers 114
- wireless antennas, identifying 8
- wireless light 10, 13
- wireless, product description 4
- WLAN antennas, identifying 8
- WLAN module
 - removal 69
 - spare part numbers 29, 38, 39, 69
- workstation guidelines 55
- WWAN antennas, identifying 8
- WWAN module
 - removal 67
 - spare part numbers 29, 39, 67

Free Manuals Download Website

<http://myh66.com>

<http://usermanuals.us>

<http://www.somanuals.com>

<http://www.4manuals.cc>

<http://www.manual-lib.com>

<http://www.404manual.com>

<http://www.luxmanual.com>

<http://aubethermostatmanual.com>

Golf course search by state

<http://golfingnear.com>

Email search by domain

<http://emailbydomain.com>

Auto manuals search

<http://auto.somanuals.com>

TV manuals search

<http://tv.somanuals.com>